

MIRELLA-G2-WW

~50° wide beam compatible with LEDiL HEKLA

TECHNICAL SPECIFICATIONS:

Dimensions	Ø 49.9 mm
Height	22.6 mm
Fastening	socket
ROHS compliant	yes ⓘ

MATERIAL SPECIFICATIONS:

Component	Type	Material	Colour	Finish	Coating
MIRELLA-G2-WW	Reflector	PC	metal		





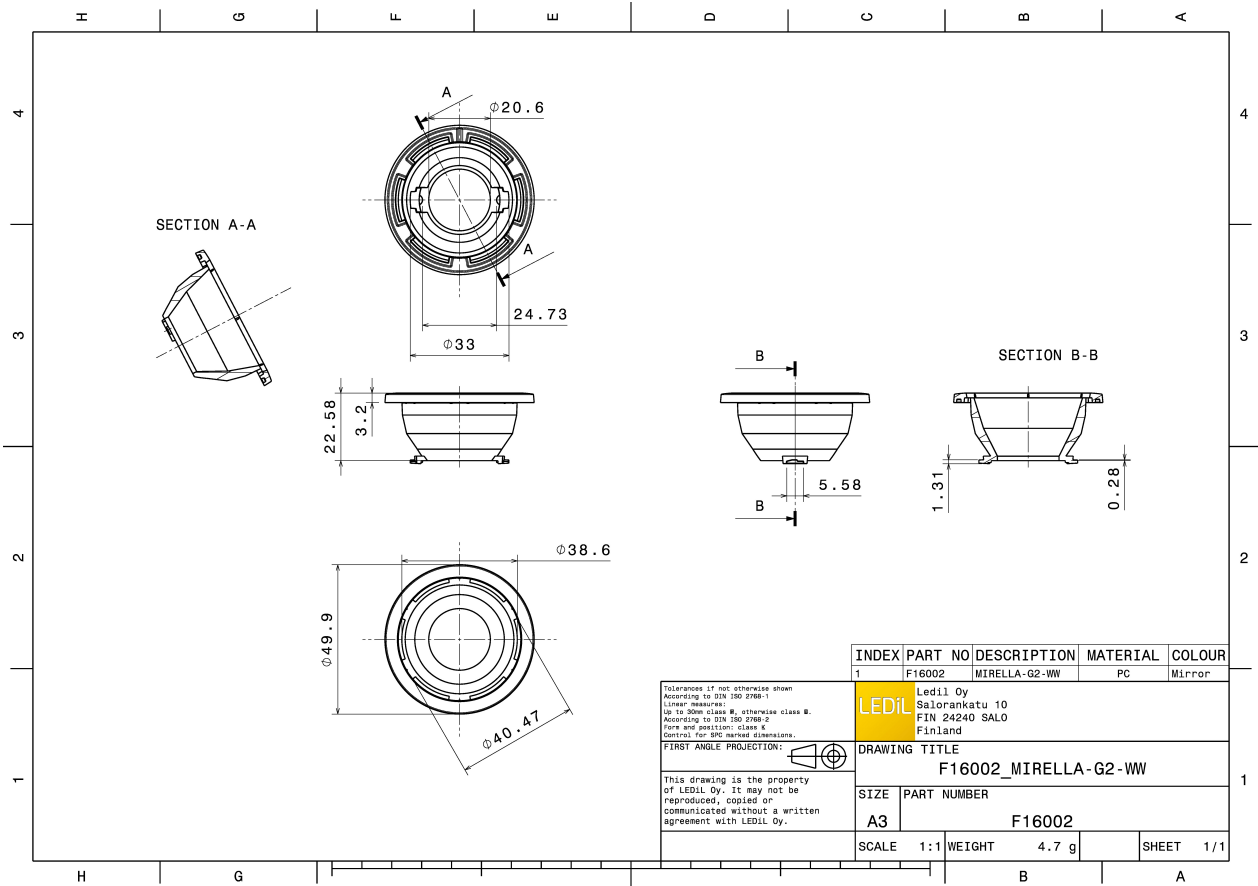

ORDERING INFORMATION:

Component	Qty in box	MOQ	MPQ	Box weight (kg)
F16002_MIRELLA-G2-WW » Box size: 480 x 280 x 300 mm	336		28	3.7



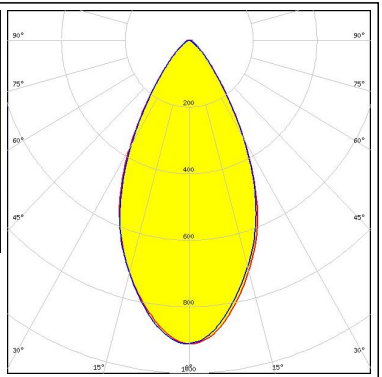
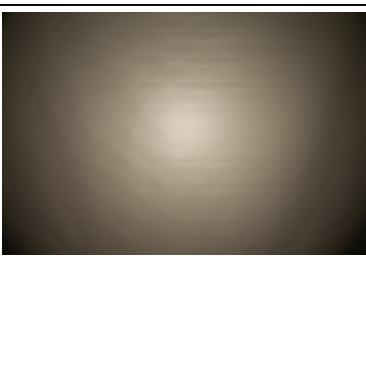
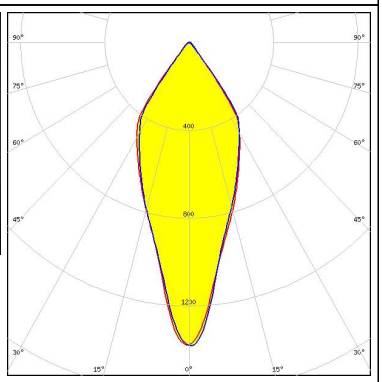

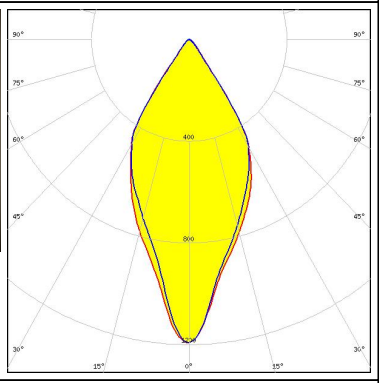

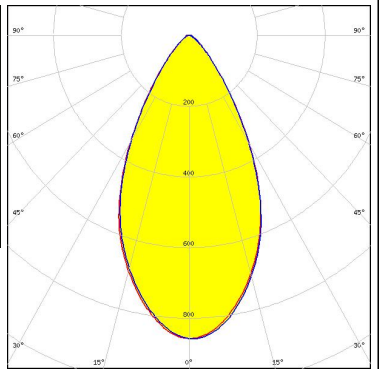
See also our general installation guide: www.ledil.com/installation_guide



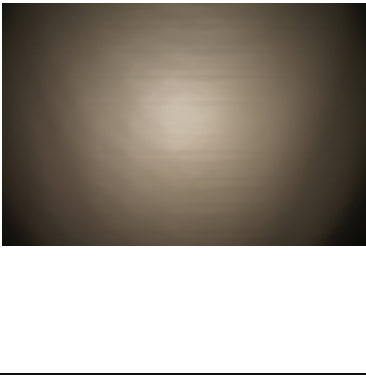
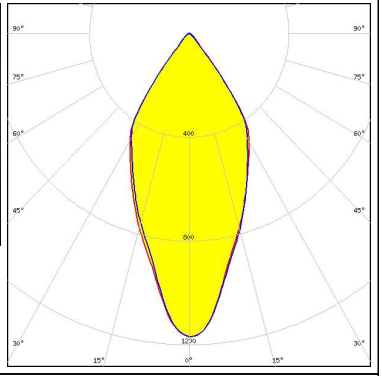

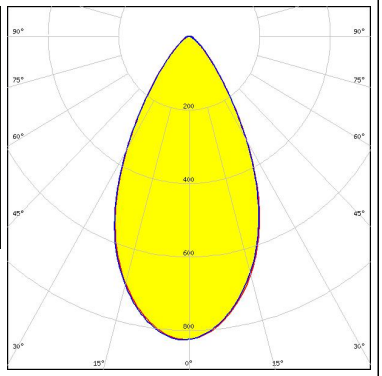

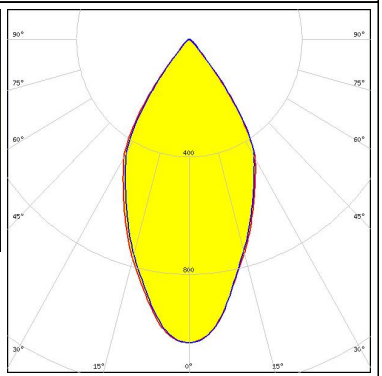
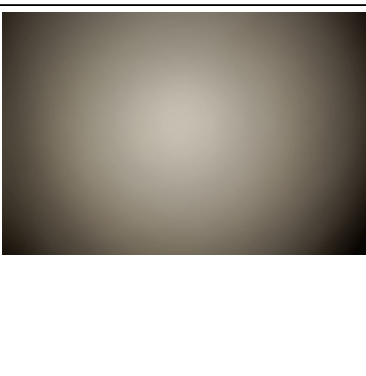
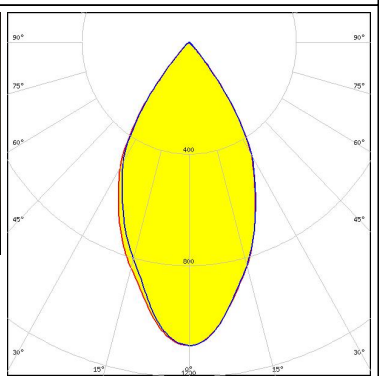
PHOTOMETRIC DATA (MEASURED):

<p>bridgelux.</p> <p>LED V4 HD</p> <p>FWHM / FWTM 53.0° / 88.0°</p> <p>Efficiency 77 %</p> <p>Peak intensity 0.9 cd/lm</p> <p>LEDs/each optic 1</p> <p>Light colour White</p> <p>Required components:</p> <p>F15253_HEKLA-SOCKET-A</p> <p>C13723_MIRELLA-RZL</p>		
<p>bridgelux.</p> <p>LED V4 HD</p> <p>FWHM / FWTM 38.0° / 78.0°</p> <p>Efficiency 85 %</p> <p>Peak intensity 1.4 cd/lm</p> <p>LEDs/each optic 1</p> <p>Light colour White</p> <p>Required components:</p> <p>F15253_HEKLA-SOCKET-A</p>		
<p>bridgelux.</p> <p>LED V4 HD</p> <p>FWHM / FWTM 49.0° / 75.0°</p> <p>Efficiency 79 %</p> <p>Peak intensity 1.2 cd/lm</p> <p>LEDs/each optic 1</p> <p>Light colour White</p> <p>Required components:</p> <p>F15253_HEKLA-SOCKET-A</p> <p>C13333_MIRELLA-CL</p>		
<p>bridgelux.</p> <p>LED V6 HD</p> <p>FWHM / FWTM 54.0° / 89.0°</p> <p>Efficiency 75 %</p> <p>Peak intensity 0.9 cd/lm</p> <p>LEDs/each optic 1</p> <p>Light colour White</p> <p>Required components:</p> <p>F15255_HEKLA-SOCKET-C</p> <p>C13723_MIRELLA-RZL</p>		

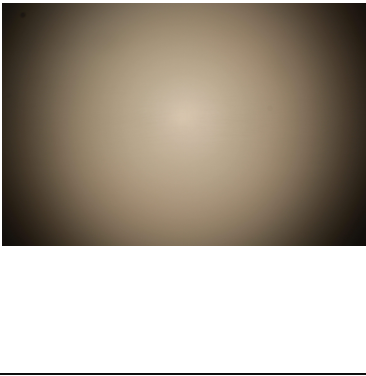
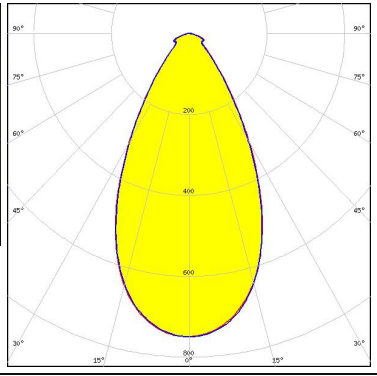

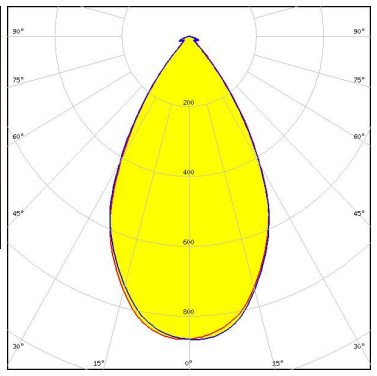
PHOTOMETRIC DATA (MEASURED):

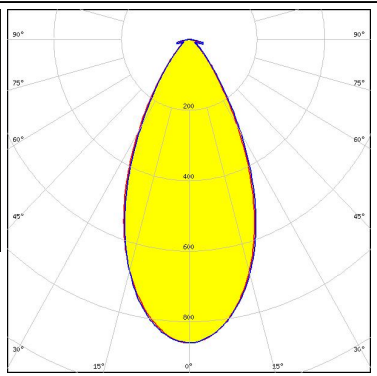
<p>bridgelux.</p> <p>LED V6 HD FWHM / FWTM 47.0° / 80.0° Efficiency 83 % Peak intensity 1.2 cd/lm LEDs/each optic 1 Light colour White Required components: F15255_HEKLA-SOCKET-C</p>		
<p>bridgelux.</p> <p>LED V9 HD FWHM / FWTM 55.0° / 89.0° Efficiency 74 % Peak intensity 0.8 cd/lm LEDs/each optic 1 Light colour White Required components: F15859_HEKLA-SOCKET-I C13723_MIRELLA-RZL</p>		
<p>bridgelux.</p> <p>LED V9 HD FWHM / FWTM 53.0° / 82.0° Efficiency 81 % Peak intensity 1 cd/lm LEDs/each optic 1 Light colour White Required components: F15859_HEKLA-SOCKET-I</p>		
<p>bridgelux.</p> <p>LED VERO10 FWHM / FWTM 55.0° / 82.0° Efficiency 85 % Peak intensity 1.1 cd/lm LEDs/each optic 1 Light colour White Required components: F15616_HEKLA-SOCKET-F</p>		

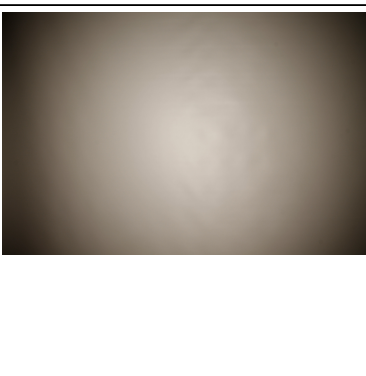
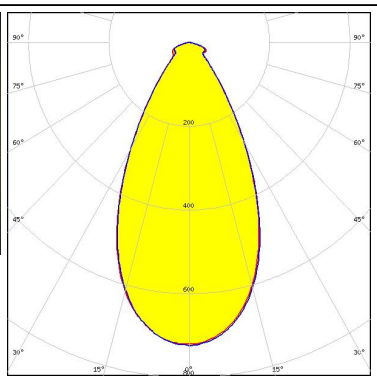
PHOTOMETRIC DATA (MEASURED):

<p></p> <p>LED Vesta DTW 13mm (21W) FWHM / FWTM 54.0° / 91.0° Efficiency 73 % Peak intensity 0.8 cd/lm LEDs/each optic 1 Light colour Tunable White</p> <p>Required components: C16142_HEKLA-SOCKET-K C13723_MIRELLA-RZL Bender Wirth: 491 Typ L8</p>		
<p></p> <p>LED Vesta DTW 13mm (21W) FWHM / FWTM 59.0° / 84.0° Efficiency 81 % Peak intensity 0.9 cd/lm LEDs/each optic 1 Light colour Tunable White</p> <p>Required components: C16142_HEKLA-SOCKET-K Bender Wirth: 491 Typ L8</p>		
<p></p> <p>LED Vesta DTW 9mm (4W/6W/12W) FWHM / FWTM 50.0° / 85.0° Efficiency 71 % Peak intensity 0.9 cd/lm LEDs/each optic 1 Light colour White</p> <p>Required components: C16142_HEKLA-SOCKET-K C13723_MIRELLA-RZL Bender Wirth: 490 Typ L8</p>		
<p></p> <p>LED Vesta TW 13mm (25W) CSP FWHM / FWTM 53.0° / 90.0° Efficiency 69 % Peak intensity 0.7 cd/lm LEDs/each optic 1 Light colour White</p> <p>Required components: C16142_HEKLA-SOCKET-K C13723_MIRELLA-RZL Bender Wirth: 492 Typ L8</p>		

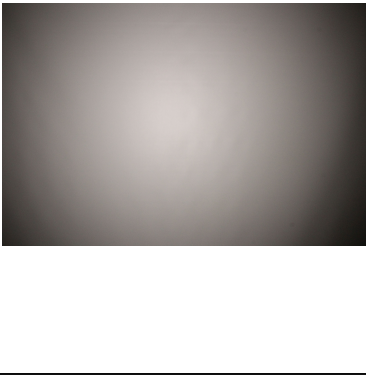
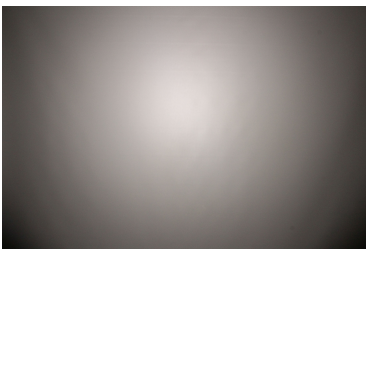
PHOTOMETRIC DATA (MEASURED):

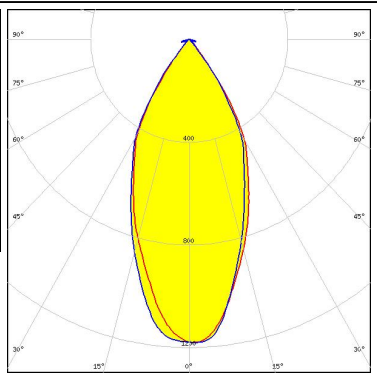
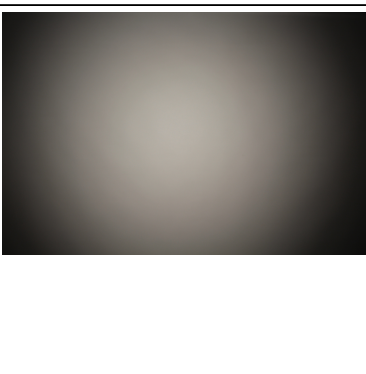
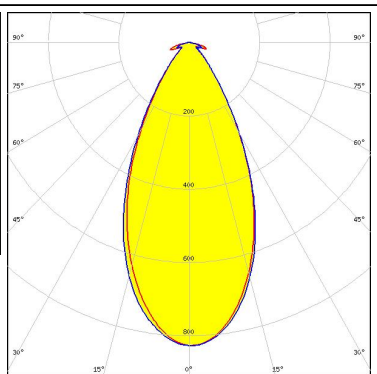
<p>bridgelux.</p> <p>LED Vesta TW 6mm DP</p> <p>FWHM / FWTM 50.0° / 85.0°</p> <p>Efficiency 74 %</p> <p>Peak intensity 0.9 cd/lm</p> <p>LEDs/each optic 1</p> <p>Light colour White</p> <p>Required components:</p> <ul style="list-style-type: none"> C16142_HEKLA-SOCKET-K C13723_MIRELLA-RZL <p>Bender Wirth: 504 Typ L8</p>		
<p>bridgelux.</p> <p>LED Vesta TW 6mm DP</p> <p>FWHM / FWTM 41.0° / 77.0°</p> <p>Efficiency 81 %</p> <p>Peak intensity 1.3 cd/lm</p> <p>LEDs/each optic 1</p> <p>Light colour White</p> <p>Required components:</p> <ul style="list-style-type: none"> C16142_HEKLA-SOCKET-K <p>Bender Wirth: 504 Typ L8</p>		
<p>bridgelux.</p> <p>LED Vesta TW 9mm (12W) CSP</p> <p>FWHM / FWTM 46.0° / 77.0°</p> <p>Efficiency 77 %</p> <p>Peak intensity 1.2 cd/lm</p> <p>LEDs/each optic 1</p> <p>Light colour White</p> <p>Required components:</p> <ul style="list-style-type: none"> C16142_HEKLA-SOCKET-K <p>Bender Wirth: 490 Typ L8</p>		
<p>bridgelux.</p> <p>LED Vesta TW 9mm (12W) CSP</p> <p>FWHM / FWTM 50.0° / 85.0°</p> <p>Efficiency 70 %</p> <p>Peak intensity 0.8 cd/lm</p> <p>LEDs/each optic 1</p> <p>Light colour White</p> <p>Required components:</p> <ul style="list-style-type: none"> C16142_HEKLA-SOCKET-K C13723_MIRELLA-RZL <p>Bender Wirth: 489 Typ L8</p>		

PHOTOMETRIC DATA (MEASURED):

CITIZEN

LED CLC020 Series (Dim-To-Warm)
 FWHM / FWTM 49.0° / 78.0°
 Efficiency 77 %
 Peak intensity 1.1 cd/lm
 LEDs/each optic 1
 Light colour White
 Required components:
 C16142_HEKLA-SOCKET-K

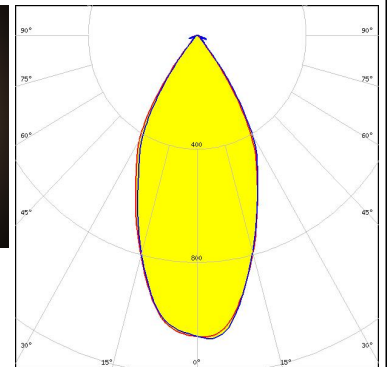
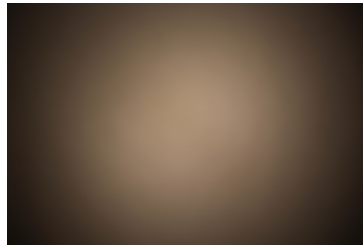

CITIZEN

LED CLC020 Series (Dim-To-Warm)
 FWHM / FWTM 50.0° / 85.0°
 Efficiency 70 %
 Peak intensity 0.8 cd/lm
 LEDs/each optic 1
 Light colour White
 Required components:
 C16142_HEKLA-SOCKET-K
 C13723_MIRELLA-RZL
 Bender Wirth: 487 Typ L8

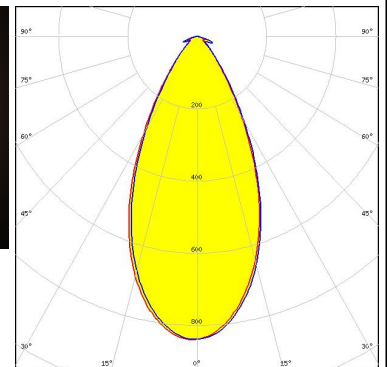
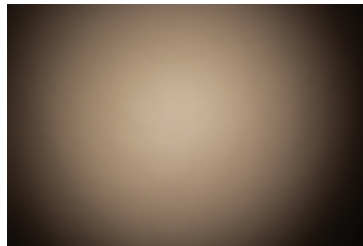

CITIZEN

LED CLL02x/CLU02x (LES10)
 FWHM / FWTM 59.0° / 83.0°
 Efficiency 82 %
 Peak intensity 1 cd/lm
 LEDs/each optic 1
 Light colour White
 Required components:
 F15255_HEKLA-SOCKET-C

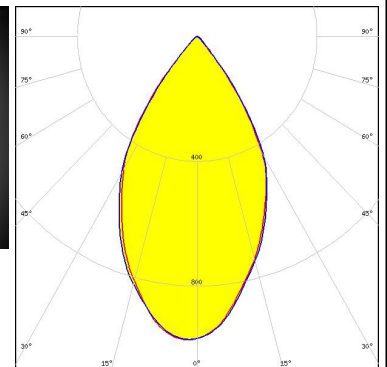
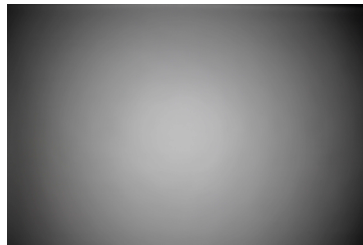

CITIZEN

LED CLU700/701/702
 FWHM / FWTM 45.0° / 79.0°
 Efficiency 85 %
 Peak intensity 1.3 cd/lm
 LEDs/each optic 1
 Light colour White
 Required components:
 F15255_HEKLA-SOCKET-C

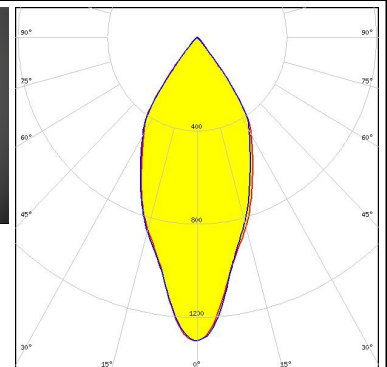
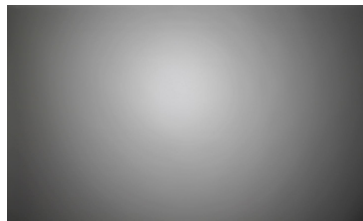

PHOTOMETRIC DATA (MEASURED):

CITIZEN

LED CLU700/701/702
 FWHM / FWTM 44.0° / 79.0°
 Efficiency 85 %
 Peak intensity 1.3 cd/lm
 LEDs/each optic 1
 Light colour White
 Required components:
 F15255_HEKLA-SOCKET-C
 C13723_MIRELLA-RZL

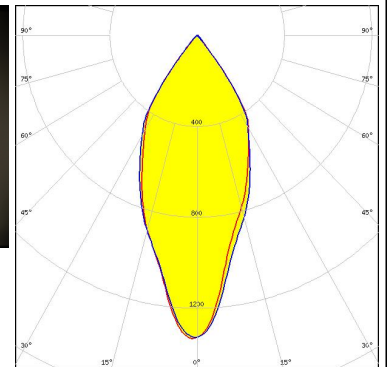

CITIZEN

LED CLU710/711
 FWHM / FWTM 53.0° / 81.0°
 Efficiency 80 %
 Peak intensity 1 cd/lm
 LEDs/each optic 1
 Light colour White
 Required components:
 F15859_HEKLA-SOCKET-I

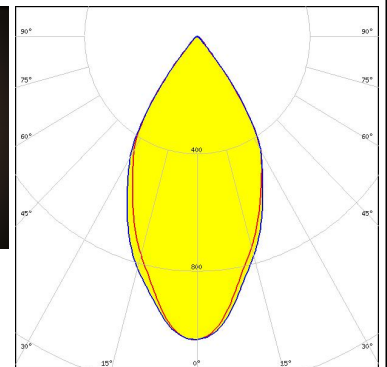
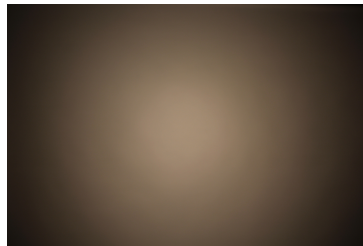

CITIZEN

LED CLU7A2 (LES 4.2mm)
 FWHM / FWTM 38.0° / 77.0°
 Efficiency 83 %
 Peak intensity 1.4 cd/lm
 LEDs/each optic 1
 Light colour White
 Required components:
 F15255_HEKLA-SOCKET-C

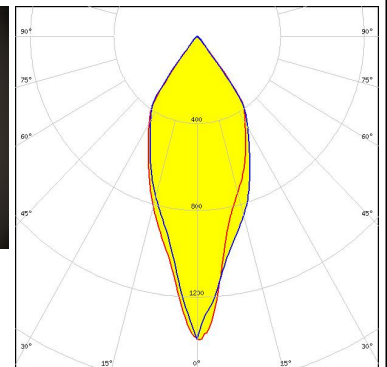
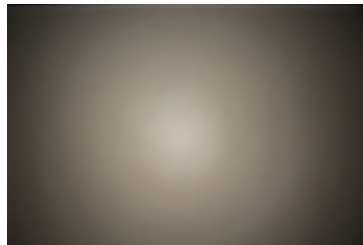

CITIZEN

LED LCN-C01B (Tunable White)
 FWHM / FWTM 50.0° / 86.0°
 Efficiency 70 %
 Peak intensity 0.8 cd/lm
 LEDs/each optic 1
 Light colour White
 Required components:
 C16142_HEKLA-SOCKET-K
 C13723_MIRELLA-RZL
 Bender Wirth: 481 Typ L8

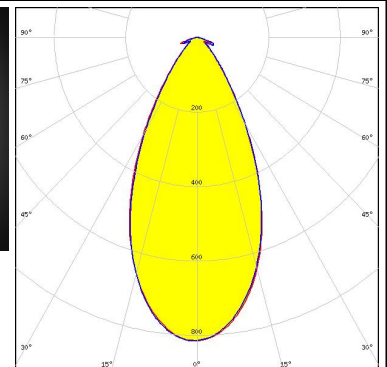
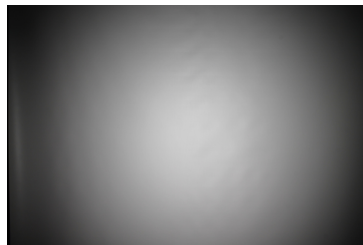

PHOTOMETRIC DATA (MEASURED):

CREE LED

LED CMA1516
 FWHM / FWTM 57.0° / 83.0°
 Efficiency 84 %
 Peak intensity 1 cd/lm
 LEDs/each optic 1
 Light colour White
 Required components:
 F15256_HEKLA-SOCKET-D

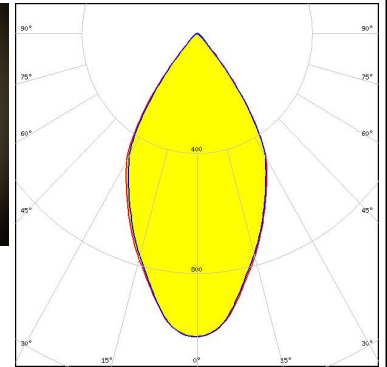
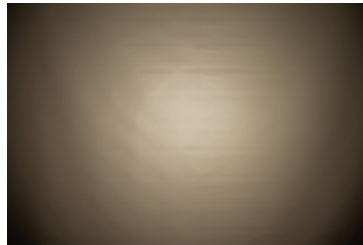

CREE LED

LED CMT14xx
 FWHM / FWTM 58.0° / 83.0°
 Efficiency 83 %
 Peak intensity 1 cd/lm
 LEDs/each optic 1
 Light colour White
 Required components:
 F15255_HEKLA-SOCKET-C

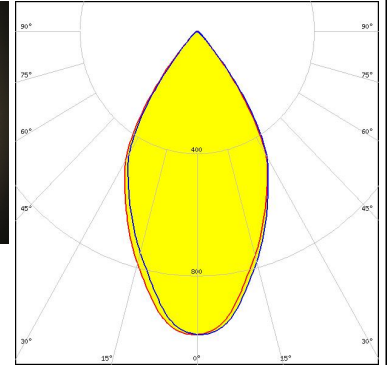

CREE LED

LED CXA/B 13xx
 FWHM / FWTM 43.0° / 78.0°
 Efficiency 86 %
 Peak intensity 1.4 cd/lm
 LEDs/each optic 1
 Light colour White
 Required components:
 F15956_HEKLA-SOCKET-J

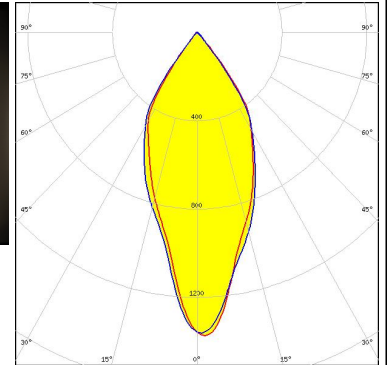

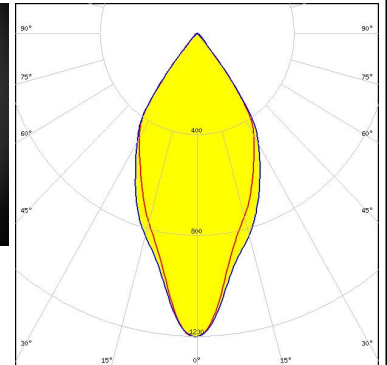
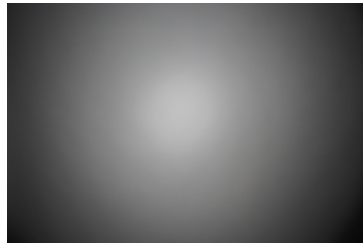

CREE LED

LED CXA/B 13xx
 FWHM / FWTM 48.0° / 80.0°
 Efficiency 84 %
 Peak intensity 1.2 cd/lm
 LEDs/each optic 1
 Light colour White
 Required components:
 F15956_HEKLA-SOCKET-J



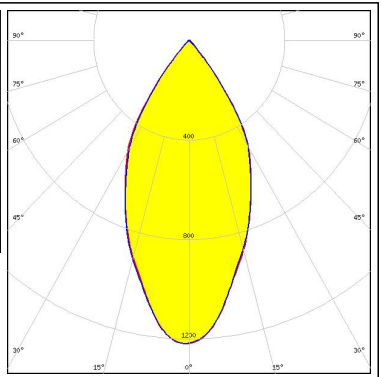

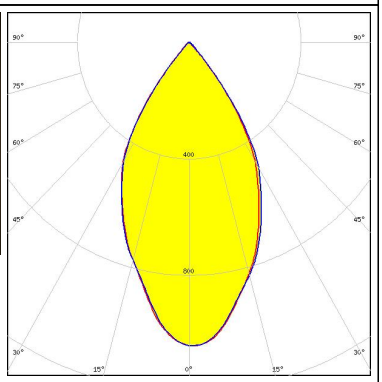
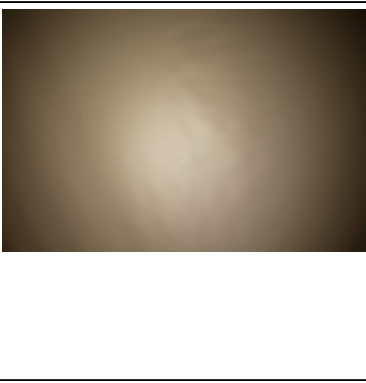
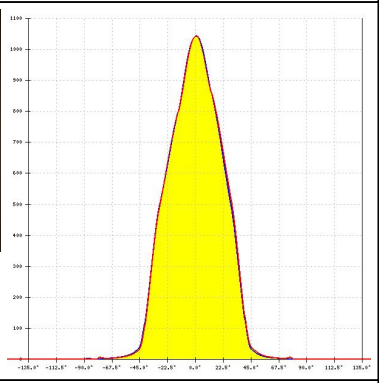
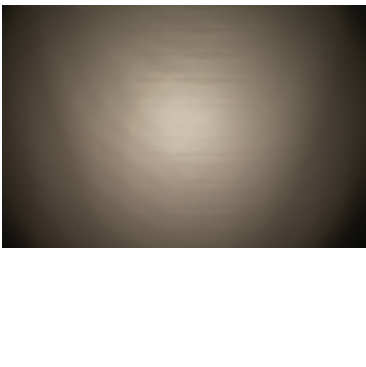
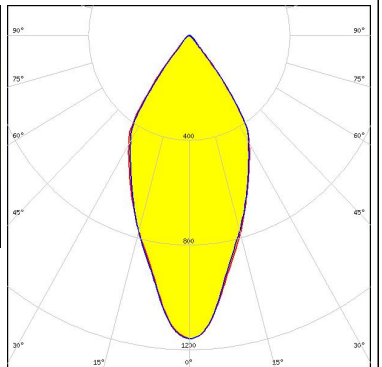

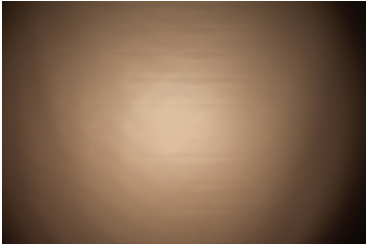
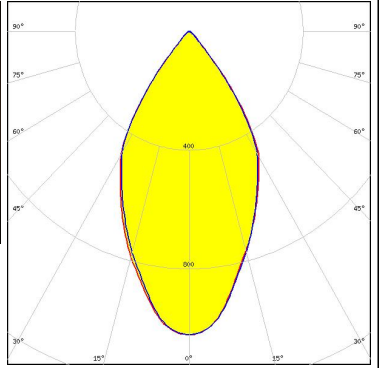
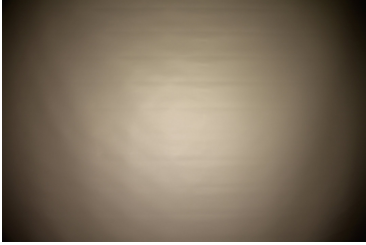
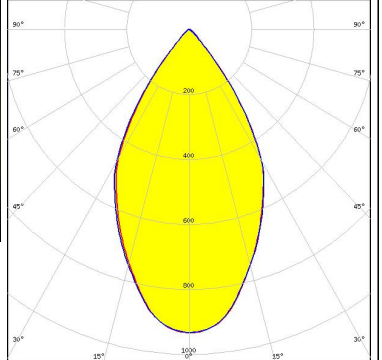
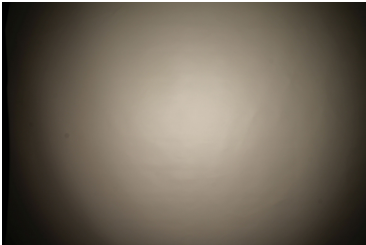
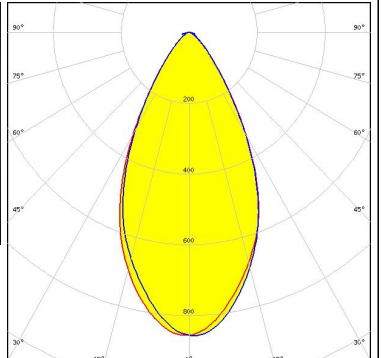
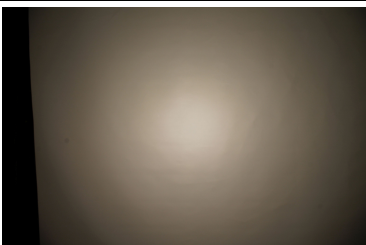
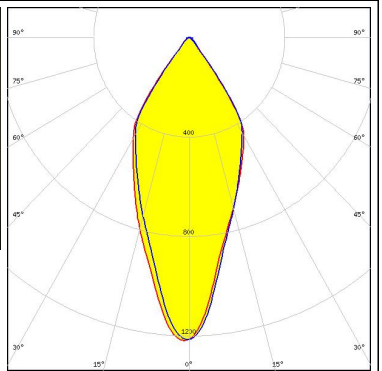

PHOTOMETRIC DATA (MEASURED):

<p>CREE LED</p> <p>LED CXA/B 15xx FWHM / FWTM 51.0° / 81.0° Efficiency 89 % Peak intensity 1.2 cd/lm LEDs/each optic 1 Light colour White Required components: F15256_HEKLA-SOCKET-D</p>		
<p>LUMILEDS</p> <p>LED LUXEON CoB 1202/1203 FWHM / FWTM 56.0° / 82.0° Efficiency 83 % Peak intensity 1 cd/lm LEDs/each optic 1 Light colour White Required components: F15858_HEKLA-SOCKET-H C12479_MIRELLA-DL</p>		
<p>LUMILEDS</p> <p>LED LUXEON CoB 1202/1203 FWHM / FWTM 56.0° / 82.0° Efficiency 83 % Peak intensity 1 cd/lm LEDs/each optic 1 Light colour White Required components: F15858_HEKLA-SOCKET-H</p>		
<p>LUMILEDS</p> <p>LED LUXEON CoB 1202HD FWHM / FWTM 48.0° / 80.0° Efficiency 83 % Peak intensity 1.2 cd/lm LEDs/each optic 1 Light colour White Required components: F15848_HEKLA-SOCKET-G</p>		

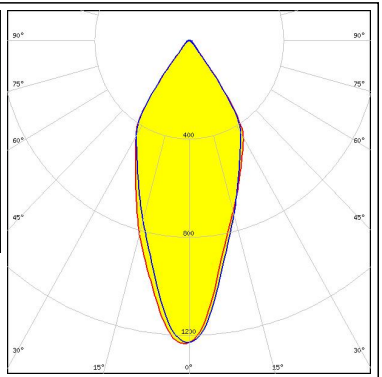

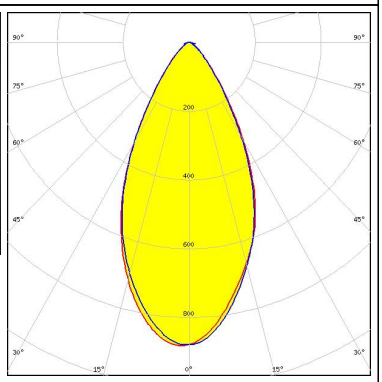
PHOTOMETRIC DATA (MEASURED):

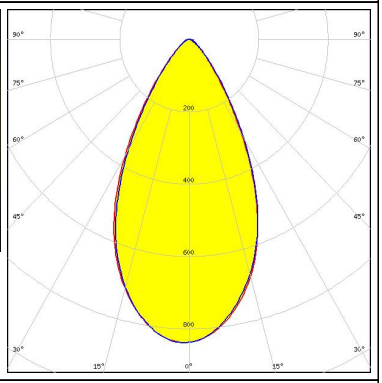
<p>LUMILEDS</p> <p>LED LUXEON CoB 1204HD</p> <p>FWHM / FWTM 56.0° / 83.0°</p> <p>Efficiency 84 %</p> <p>Peak intensity 1 cd/lm</p> <p>LEDs/each optic 1</p> <p>Light colour White</p> <p>Required components: F15858_HEKLA-SOCKET-H</p>		
<p>LUMILEDS</p> <p>LED LUXEON CoB 1205HD</p> <p>FWHM / FWTM 59.0° / 85.0°</p> <p>Efficiency 81 %</p> <p>Peak intensity 0.9 cd/lm</p> <p>LEDs/each optic 1</p> <p>Light colour White</p> <p>Required components: F15858_HEKLA-SOCKET-H</p>		
<p>LUMILEDS</p> <p>LED LUXEON CX Plus CoB - HD S01H4</p> <p>FWHM / FWTM 53.0 + 52.0° / 88.0°</p> <p>Efficiency 73 %</p> <p>Peak intensity 0.9 cd/lm</p> <p>LEDs/each optic 1</p> <p>Light colour White</p> <p>Required components: C13723_MIRELLA-RZL Bender Wirth: 634c Hekla</p>		
<p>LUMILEDS</p> <p>LED LUXEON CX Plus CoB - HD S01H4</p> <p>FWHM / FWTM 42.0° / 78.0°</p> <p>Efficiency 79 %</p> <p>Peak intensity 1.2 cd/lm</p> <p>LEDs/each optic 1</p> <p>Light colour White</p> <p>Required components: Bender Wirth: 634c Hekla</p>		

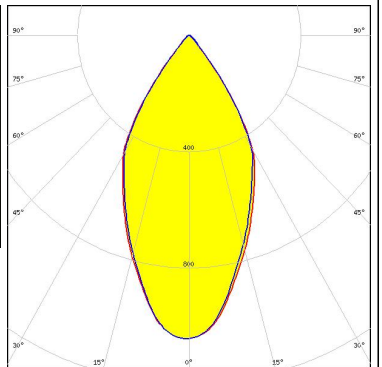
PHOTOMETRIC DATA (MEASURED):

<p>LUMILEDS</p> <p>LED LUXEON CX Plus CoB - HD S01H6 / HD S02H6</p> <p>FWHM / FWTM 42.0° / 78.0°</p> <p>Efficiency 79 %</p> <p>Peak intensity 1.2 cd/lm</p> <p>LEDs/each optic 1</p> <p>Light colour White</p> <p>Required components: Bender Wirth: 634c Hekla</p>		
<p>LUMILEDS</p> <p>LED LUXEON CX Plus CoB - HD S01H6 / HD S02H6</p> <p>FWHM / FWTM 52.0° / 87.0°</p> <p>Efficiency 73 %</p> <p>Peak intensity 0.9 cd/lm</p> <p>LEDs/each optic 1</p> <p>Light colour White</p> <p>Required components: C13723_MIRELLA-RZL Bender Wirth: 634c Hekla</p>		
<p>LUMILEDS</p> <p>LED LUXEON CX Plus CoB - HD S04H9</p> <p>FWHM / FWTM 54.0° / 89.0°</p> <p>Efficiency 74 %</p> <p>Peak intensity 0.8 cd/lm</p> <p>LEDs/each optic 1</p> <p>Light colour White</p> <p>Required components: C13723_MIRELLA-RZL Bender Wirth: 634c Hekla</p>		
<p>LUMILEDS</p> <p>LED LUXEON CX Plus CoB - HD S04H9</p> <p>FWHM / FWTM 53.0° / 81.0°</p> <p>Efficiency 81 %</p> <p>Peak intensity 1 cd/lm</p> <p>LEDs/each optic 1</p> <p>Light colour White</p> <p>Required components: Bender Wirth: 634c Hekla</p>		

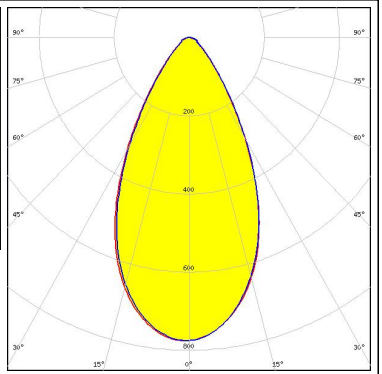

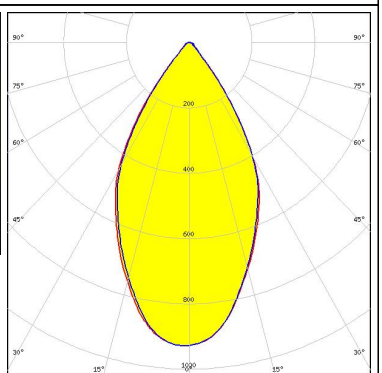
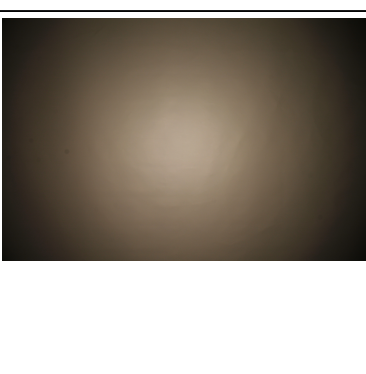
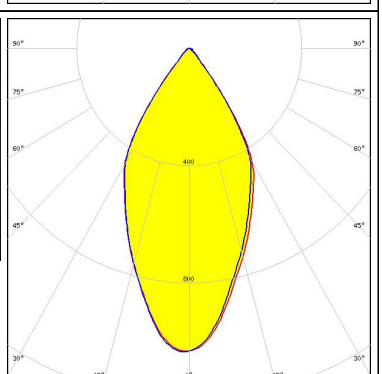
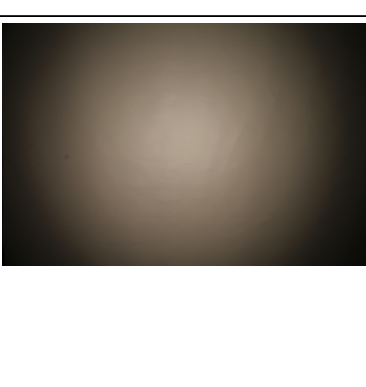
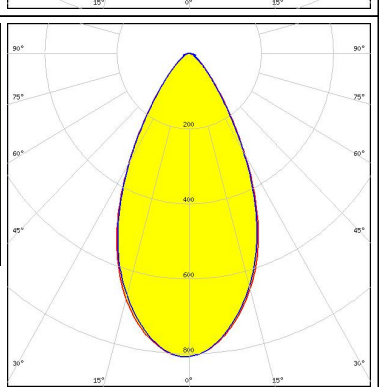

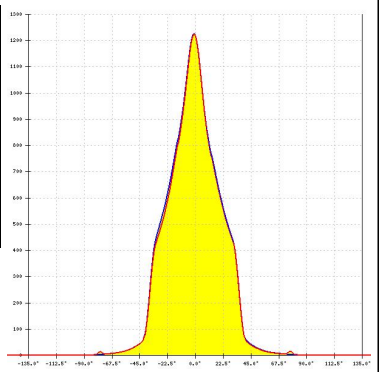
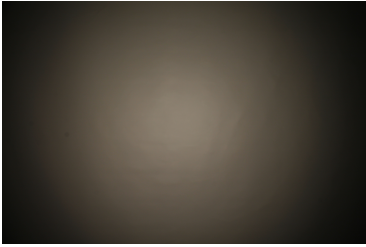
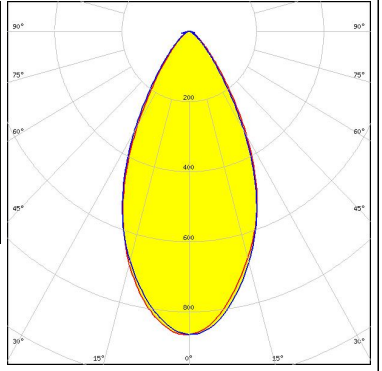
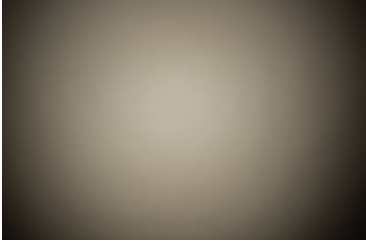
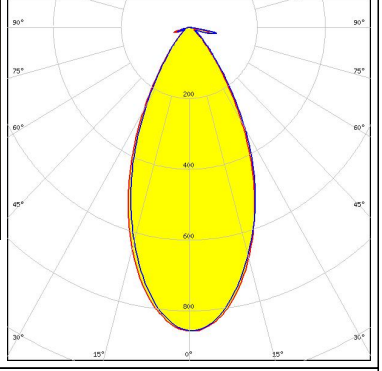
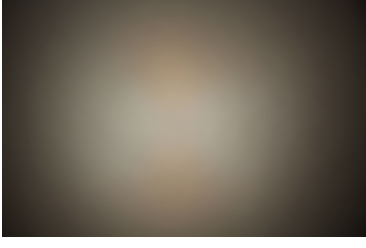
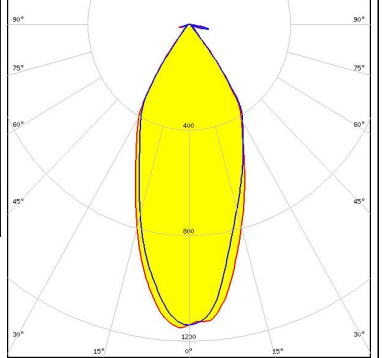

PHOTOMETRIC DATA (MEASURED):

<p>LUMILEDS</p> <p>LED LUXEON CX Plus CoB L04 / L05 (Gen2)</p> <p>FWHM / FWTM 54.0° / 91.0°</p> <p>Efficiency 71 %</p> <p>Peak intensity 0.8 cd/lm</p> <p>LEDs/each optic 1</p> <p>Light colour White</p> <p>Required components: C13723_MIRELLA-RZL Bender Wirth: 637a Hekla</p>		
<p>LUMILEDS</p> <p>LED LUXEON CX Plus CoB L04 / L05 (Gen2)</p> <p>FWHM / FWTM 58.0° / 83.0°</p> <p>Efficiency 78 %</p> <p>Peak intensity 0.9 cd/lm</p> <p>LEDs/each optic 1</p> <p>Light colour White</p> <p>Required components: Bender Wirth: 637a Hekla</p>		
<p>LUMILEDS</p> <p>LED LUXEON CX Plus CoB M02 / M03 (Gen2)</p> <p>FWHM / FWTM 52.0° / 81.0°</p> <p>Efficiency 79 %</p> <p>Peak intensity 1 cd/lm</p> <p>LEDs/each optic 1</p> <p>Light colour White</p> <p>Required components: Bender Wirth: 641a Hekla</p>		
<p>LUMILEDS</p> <p>LED LUXEON CX Plus CoB M02 / M03 (Gen2)</p> <p>FWHM / FWTM 53.0° / 89.0°</p> <p>Efficiency 71 %</p> <p>Peak intensity 0.8 cd/lm</p> <p>LEDs/each optic 1</p> <p>Light colour White</p> <p>Required components: C13723_MIRELLA-RZL Bender Wirth: 641a Hekla</p>		

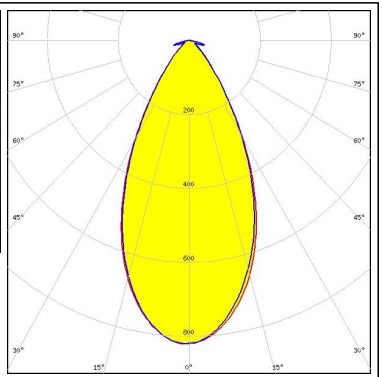

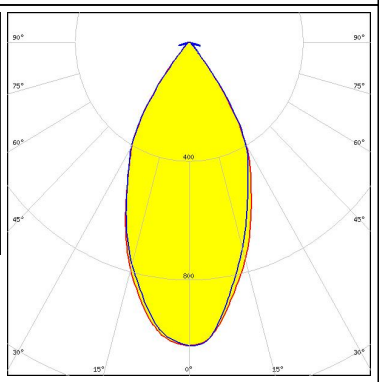

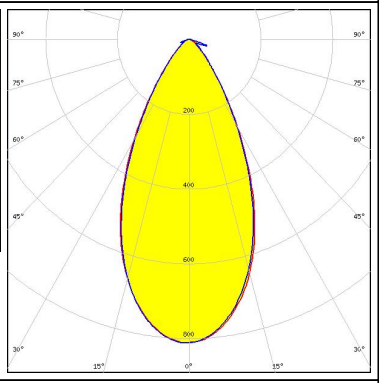
PHOTOMETRIC DATA (MEASURED):

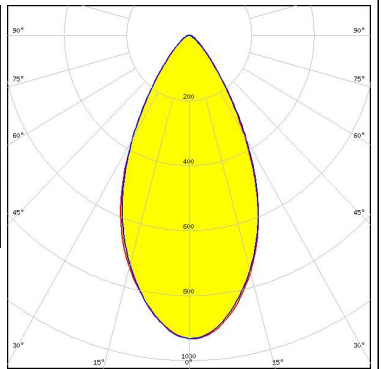
<p>LUMILEDS</p> <p>LED LUXEON CX Plus CoB S01 (Gen2)</p> <p>FWHM / FWTM 42.0° / 78.0°</p> <p>Efficiency 80 %</p> <p>Peak intensity 1.2 cd/lm</p> <p>LEDs/each optic 1</p> <p>Light colour White</p> <p>Required components: Bender Wirth: 634c Hekla</p>		
<p>LUMILEDS</p> <p>LED LUXEON CX Plus CoB S01 (Gen2)</p> <p>FWHM / FWTM 52.0° / 87.0°</p> <p>Efficiency 72 %</p> <p>Peak intensity 0.9 cd/lm</p> <p>LEDs/each optic 1</p> <p>Light colour White</p> <p>Required components: C13723_MIRELLA-RZL Bender Wirth: 634c Hekla</p>		
<p>LUMINUS</p> <p>LED CDM-6 (Dim-To-Warm)</p> <p>FWHM / FWTM 49.0° / 85.0°</p> <p>Efficiency 70 %</p> <p>Peak intensity 0.9 cd/lm</p> <p>LEDs/each optic 1</p> <p>Light colour White</p> <p>Required components: C16142_HEKLA-SOCKET-K C13723_MIRELLA-RZL Bender Wirth: 490 Typ L8</p>		
<p>LUMINUS</p> <p>LED CDM-6 (Dim-To-Warm)</p> <p>FWHM / FWTM 43.0° / 77.0°</p> <p>Efficiency 77 %</p> <p>Peak intensity 1.2 cd/lm</p> <p>LEDs/each optic 1</p> <p>Light colour White</p> <p>Required components: C16142_HEKLA-SOCKET-K Bender Wirth: 490 Typ L8</p>		

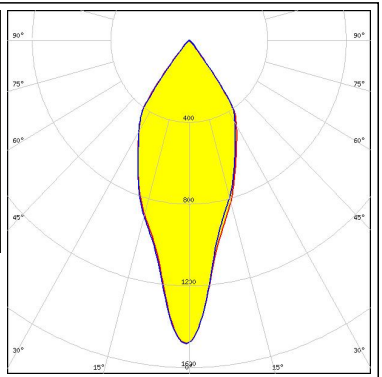
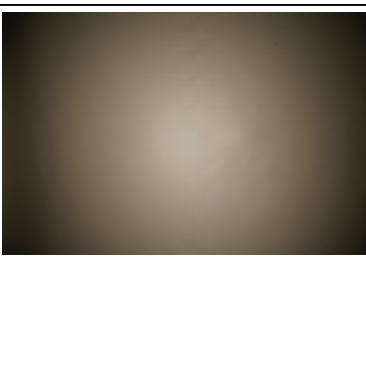
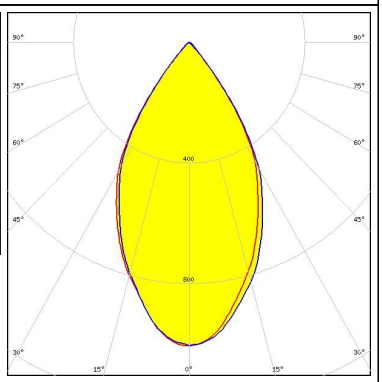

PHOTOMETRIC DATA (MEASURED):

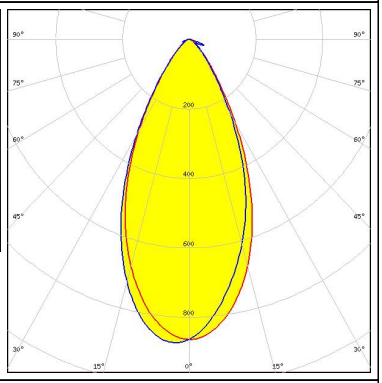
<p>LUMINUS</p> <p>LED CDM-9 (Dim-To-Warm)</p> <p>FWHM / FWTM 51.0° / 86.0°</p> <p>Efficiency 70 %</p> <p>Peak intensity 0.8 cd/lm</p> <p>LEDs/each optic 1</p> <p>Light colour White</p> <p>Required components: C16142_HEKLA-SOCKET-K C13723_MIRELLA-RZL Bender Wirth: 490 Typ L8</p>		
<p>LUMINUS</p> <p>LED CDM-9 (Dim-To-Warm)</p> <p>FWHM / FWTM 49.0° / 79.0°</p> <p>Efficiency 76 %</p> <p>Peak intensity 1 cd/lm</p> <p>LEDs/each optic 1</p> <p>Light colour White</p> <p>Required components: C16142_HEKLA-SOCKET-K Bender Wirth: 490 Typ L8</p>		
<p>LUMINUS</p> <p>LED CTM-9 (Tunable White)</p> <p>FWHM / FWTM 51.0° / 86.0°</p> <p>Efficiency 68 %</p> <p>Peak intensity 0.8 cd/lm</p> <p>LEDs/each optic 1</p> <p>Light colour White</p> <p>Required components: C16142_HEKLA-SOCKET-K C13723_MIRELLA-RZL Bender Wirth: 495 Typ L8</p>		
<p>LUMINUS</p> <p>LED CXM-4</p> <p>FWHM / FWTM 53.0° / 88.0°</p> <p>Efficiency 80 %</p> <p>Peak intensity 0.9 cd/lm</p> <p>LEDs/each optic 1</p> <p>Light colour White</p> <p>Required components: F15255_HEKLA-SOCKET-C C13723_MIRELLA-RZL</p>		

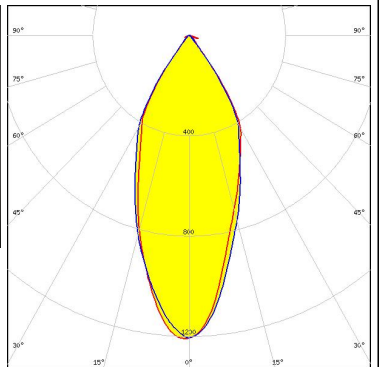
PHOTOMETRIC DATA (MEASURED):

<p>LUMINUS</p> <p>LED CXM-4 FWHM / FWTM 38.0° / 78.0° Efficiency 87 % Peak intensity 1.5 cd/lm LEDs/each optic 1 Light colour White Required components: F15255_HEKLA-SOCKET-C</p>		
<p>LUMINUS</p> <p>LED CxM-9 (13.5x13.5) FWHM / FWTM 57.0° / 82.0° Efficiency 82 % Peak intensity 1 cd/lm LEDs/each optic 1 Light colour White Required components: F15255_HEKLA-SOCKET-C</p>		
<p>NICHIA</p> <p>LED NJCWL024Z-V1MT: COB L-Type Tunable White FWHM / FWTM 49.0° / 84.0° Efficiency 69 % Peak intensity 0.9 cd/lm LEDs/each optic 1 Light colour White Required components: C16142_HEKLA-SOCKET-K C13723_MIRELLA-RZL Bender Wirth: 497 Typ L8</p>		
<p>NICHIA</p> <p>LED NJCWL024Z-V1MT: COB L-Type Tunable White FWHM / FWTM 42.0° / 76.0° Efficiency 76 % Peak intensity 1.2 cd/lm LEDs/each optic 1 Light colour White Required components: C16142_HEKLA-SOCKET-K Bender Wirth: 497 Typ L8</p>		

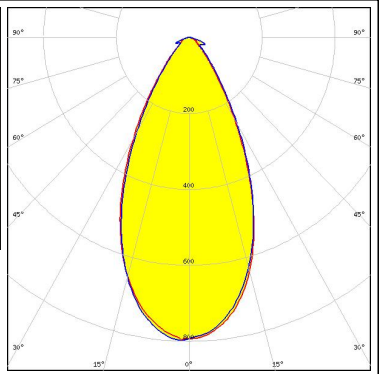
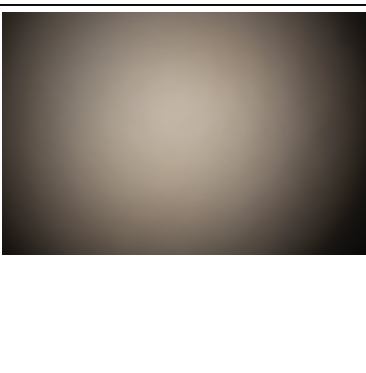
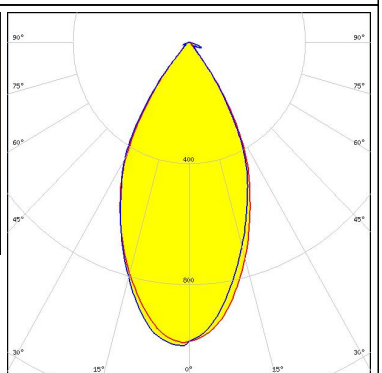
PHOTOMETRIC DATA (MEASURED):

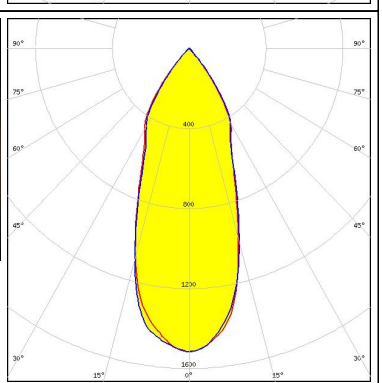
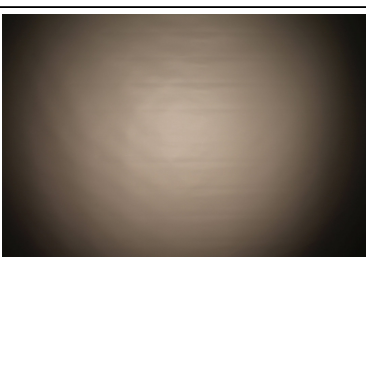
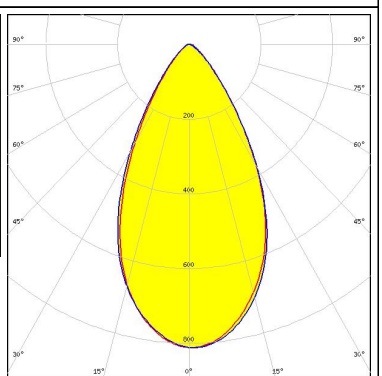
<p>NICHIA</p> <p>LED NVCWJ024Z-V1MT: COB J-Type Tunable White</p> <p>FWHM / FWTM 51.0° / 86.0°</p> <p>Efficiency 69 %</p> <p>Peak intensity 0.8 cd/lm</p> <p>LEDs/each optic 1</p> <p>Light colour White</p> <p>Required components:</p> <ul style="list-style-type: none"> C16142_HEKLA-SOCKET-K C13723_MIRELLA-RZL Bender Wirth: 498 Typ L8 		
<p>NICHIA</p> <p>LED NVCWJ024Z-V1MT: COB J-Type Tunable White</p> <p>FWHM / FWTM 52.0° / 79.0°</p> <p>Efficiency 77 %</p> <p>Peak intensity 1 cd/lm</p> <p>LEDs/each optic 1</p> <p>Light colour White</p> <p>Required components:</p> <ul style="list-style-type: none"> C16142_HEKLA-SOCKET-K Bender Wirth: 498 Typ L8 		
<p>OSRAM Opto Semiconductors</p> <p>LED Soleriq S9</p> <p>FWHM / FWTM 39.0° / 80.0°</p> <p>Efficiency 91 %</p> <p>Peak intensity 1.5 cd/lm</p> <p>LEDs/each optic 1</p> <p>Light colour White</p> <p>Required components:</p> <ul style="list-style-type: none"> F15255_HEKLA-SOCKET-C 		
<p>PHILIPS</p> <p>LED Fortimo SLM L09 CoB</p> <p>FWHM / FWTM 55.0° / 90.0°</p> <p>Efficiency 74 %</p> <p>Peak intensity 0.8 cd/lm</p> <p>LEDs/each optic 1</p> <p>Light colour White</p> <p>Required components:</p> <ul style="list-style-type: none"> F15858_HEKLA-SOCKET-H C13723_MIRELLA-RZL 		

PHOTOMETRIC DATA (MEASURED):

PHILIPS

LED Fortimo SLM L09 CoB
 FWHM / FWTM 57.0° / 83.0°
 Efficiency 82 %
 Peak intensity 1 cd/lm
 LEDs/each optic 1
 Light colour White
 Required components:
 F15858_HEKLA-SOCKET-H

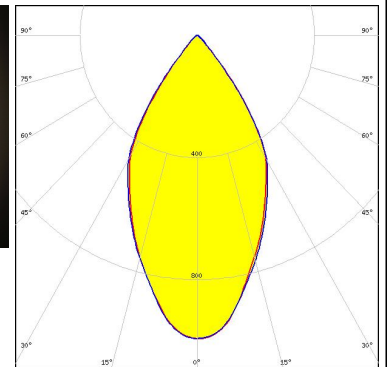
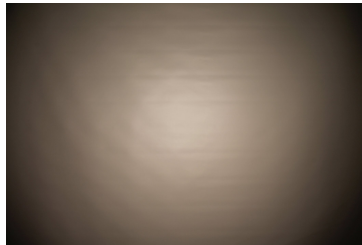

PHILIPS

LED Fortimo SLM L13 CoB
 FWHM / FWTM 54.0° / 90.0°
 Efficiency 71 %
 Peak intensity 0.7 cd/lm
 LEDs/each optic 1
 Light colour White
 Required components:
 C16142_HEKLA-SOCKET-K
 C13723_MIRELLA-RZL
 Bender Wirth: 432 Typ L8

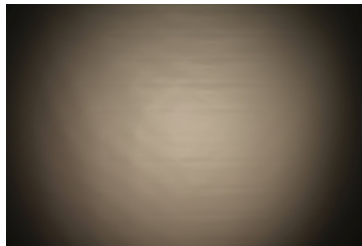

PHILIPS

LED Fortimo SLM L13 CoB
 FWHM / FWTM 54.0° / 90.0°
 Efficiency 71 %
 Peak intensity 0.7 cd/lm
 LEDs/each optic 1
 Light colour White
 Required components:
 C16142_HEKLA-SOCKET-K
 C13723_MIRELLA-RZL
 Bender Wirth: 432 Typ L8

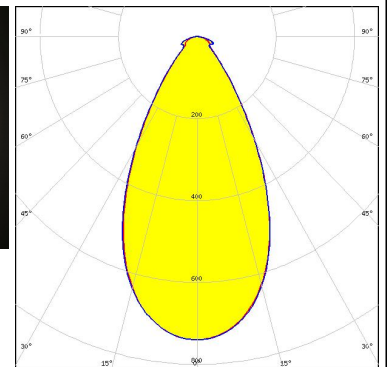
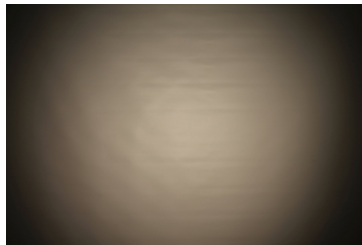

PHILIPS

LED Fortimo SLM L13 CoB
 FWHM / FWTM 58.0° / 84.0°
 Efficiency 77 %
 Peak intensity 0.8 cd/lm
 LEDs/each optic 1
 Light colour White
 Required components:
 C16142_HEKLA-SOCKET-K
 Bender Wirth: 432 Typ L8

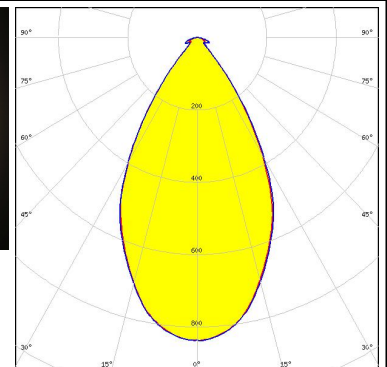
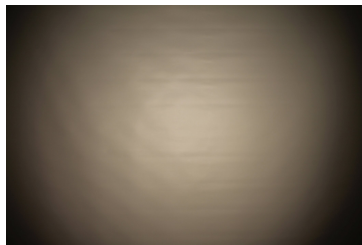

PHOTOMETRIC DATA (MEASURED):

PHILIPS

LED Fortimo SLM L13 CoB
 FWHM / FWTM 58.0° / 84.0°
 Efficiency 77 %
 Peak intensity 0.8 cd/lm
 LEDs/each optic 1
 Light colour White
 Required components:
 C16142_HEKLA-SOCKET-K
 Bender Wirth: 432 Typ L8

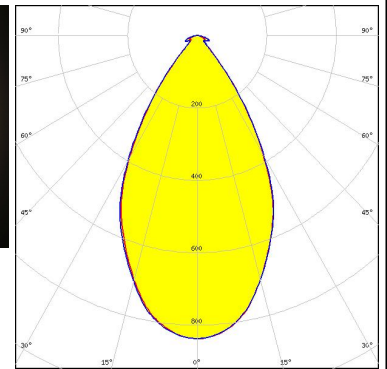

SAMSUNG

LED LC010C G2
 FWHM / FWTM 45.0° / 79.0°
 Efficiency 82 %
 Peak intensity 1.2 cd/lm
 LEDs/each optic 1
 Light colour White
 Required components:
 F15255_HEKLA-SOCKET-C

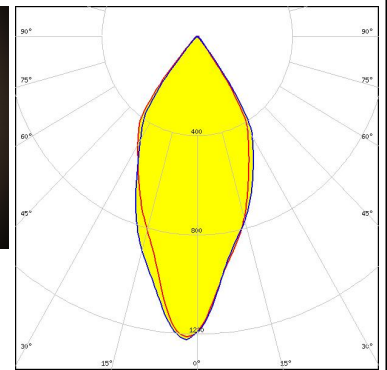
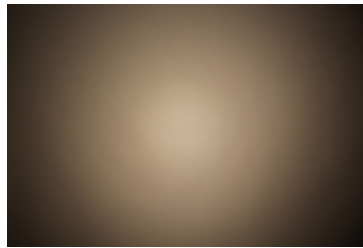

SAMSUNG

LED LC010T (Tunable White)
 FWHM / FWTM 52.0° / 76.0°
 Efficiency 78 %
 Peak intensity 1.1 cd/lm
 LEDs/each optic 1
 Light colour Tunable White
 Required components:
 C16142_HEKLA-SOCKET-K
 C14658_BARBARA-RZ-LENS
 Bender Wirth: 501 Typ L8

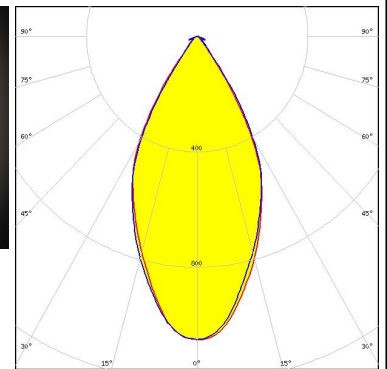
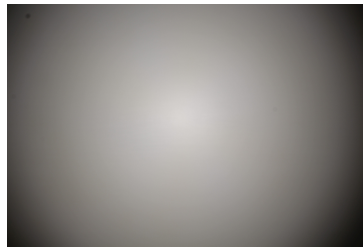

SAMSUNG

LED LC010T (Tunable White)
 FWHM / FWTM 48.0° / 79.0°
 Efficiency 82 %
 Peak intensity 1.2 cd/lm
 LEDs/each optic 1
 Light colour Tunable White
 Required components:
 C16142_HEKLA-SOCKET-K
 Bender Wirth: 501 Typ L8

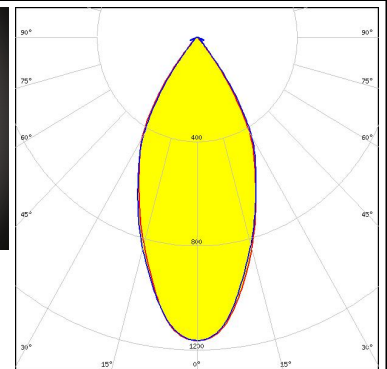
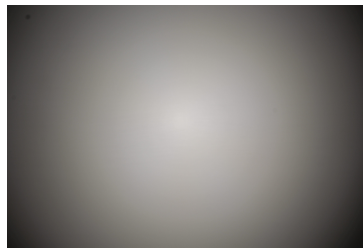

PHOTOMETRIC DATA (MEASURED):

SAMSUNG

LED LC016D / LC019D / LC026D / LC033D
 FWHM / FWTM 62.0° / 88.0°
 Efficiency 79 %
 Peak intensity 0.8 cd/lm
 LEDs/each optic 1
 Light colour White
 Required components:
 F15859_HEKLA-SOCKET-I

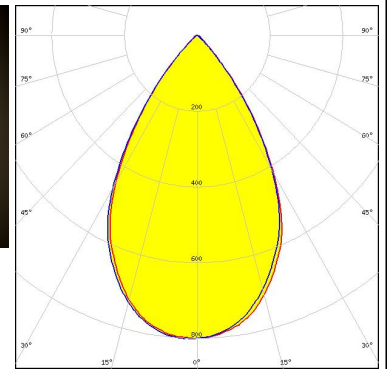
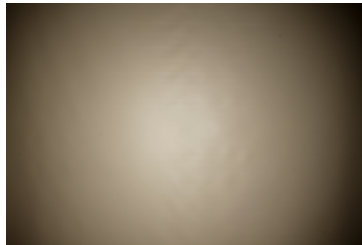

SAMSUNG

LED LC016D / LC019D / LC026D / LC033D
 FWHM / FWTM 57.0° / 94.0°
 Efficiency 71 %
 Peak intensity 0.7 cd/lm
 LEDs/each optic 1
 Light colour White
 Required components:
 F15859_HEKLA-SOCKET-I
 C13723_MIRELLA-RZL

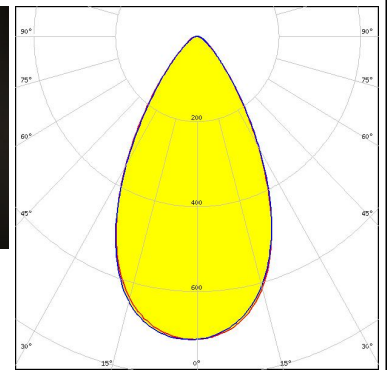
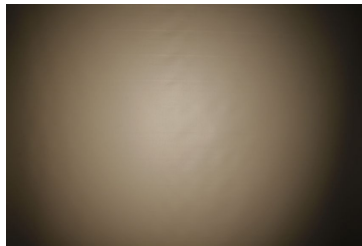

SAMSUNG

LED LC016D / LC019D / LC026D / LC033D
 FWHM / FWTM 62.0° / 86.0°
 Efficiency 75 %
 Peak intensity 0.8 cd/lm
 LEDs/each optic 1
 Light colour White
 Required components:
 F15859_HEKLA-SOCKET-I
 C13333_MIRELLA-CL

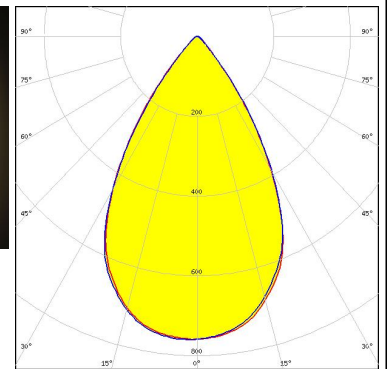
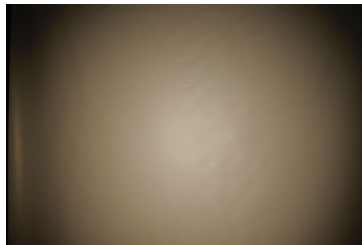

SAMSUNG

LED LC016D / LC019D / LC026D / LC033D
 FWHM / FWTM 60.0° / 90.0°
 Efficiency 73 %
 Peak intensity 0.7 cd/lm
 LEDs/each optic 1
 Light colour White
 Required components:
 F15859_HEKLA-SOCKET-I
 C12479_MIRELLA-DL

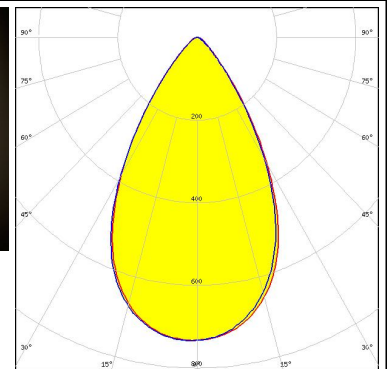
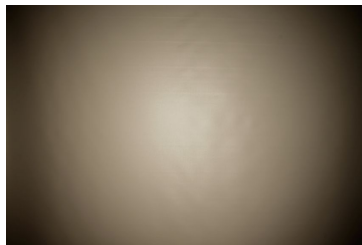

PHOTOMETRIC DATA (MEASURED):

SAMSUNG

LED LC020C
 FWHM / FWTM 56.0° / 82.0°
 Efficiency 83 %
 Peak intensity 1 cd/lm
 LEDs/each optic 1
 Light colour White
 Required components:
 F15848_HEKLA-SOCKET-G

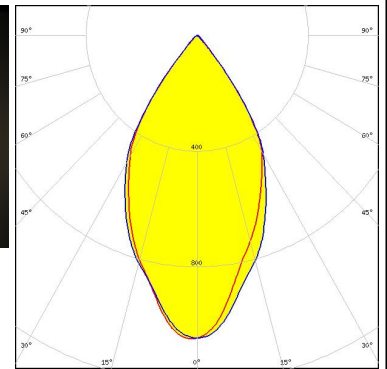

SAMSUNG

LED LC020C G2
 FWHM / FWTM 55.0° / 81.0°
 Efficiency 81 %
 Peak intensity 1 cd/lm
 LEDs/each optic 1
 Light colour White
 Required components:
 F15859_HEKLA-SOCKET-I

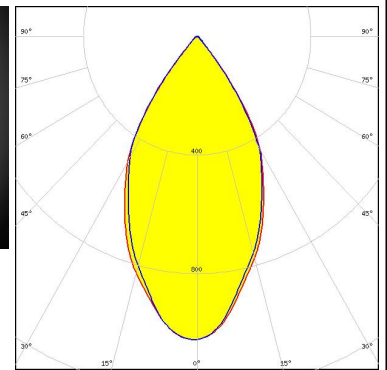
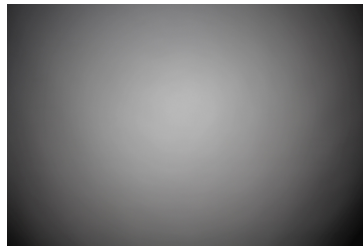

TRIDONIC

LED SLE G7 LES09
 FWHM / FWTM 54.0° / 89.0°
 Efficiency 76 %
 Peak intensity 0.9 cd/lm
 LEDs/each optic 1
 Light colour White
 Required components:
 F15255_HEKLA-SOCKET-C
 C13723_MIRELLA-RZL

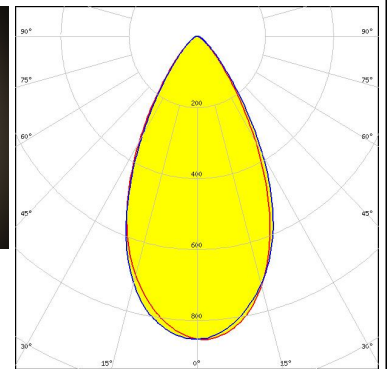
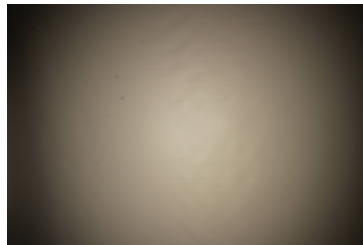

TRIDONIC

LED SLE G7 LES09
 FWHM / FWTM 56.0° / 82.0°
 Efficiency 84 %
 Peak intensity 1.1 cd/lm
 LEDs/each optic 1
 Light colour White
 Required components:
 F15255_HEKLA-SOCKET-C

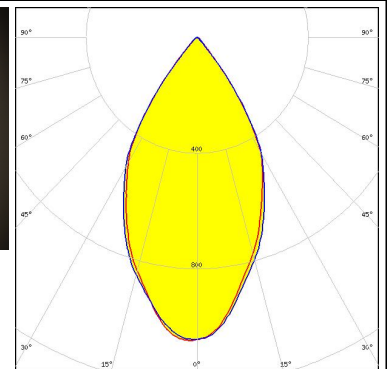
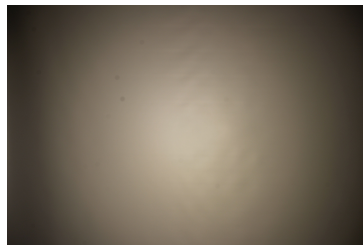

PHOTOMETRIC DATA (MEASURED):

TRIDONIC

LED SLE G7 LES13
 FWHM / FWTM 61.0° / 86.0°
 Efficiency 79 %
 Peak intensity 0.9 cd/lm
 LEDs/each optic 1
 Light colour White
 Required components:
 F15859_HEKLA-SOCKET-I

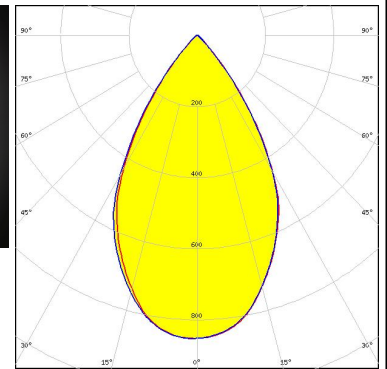
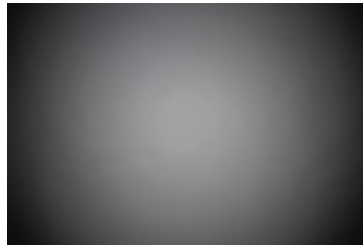

TRIDONIC

LED SLE G7 LES13
 FWHM / FWTM 56.0° / 92.0°
 Efficiency 71 %
 Peak intensity 0.7 cd/lm
 LEDs/each optic 1
 Light colour White
 Required components:
 F15859_HEKLA-SOCKET-I
 C13723_MIRELLA-RZL

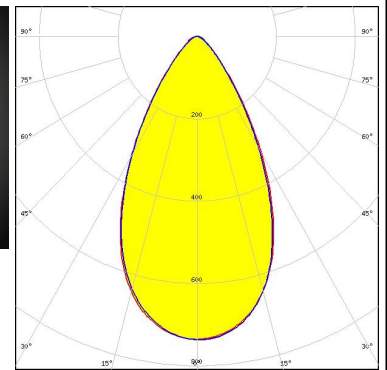
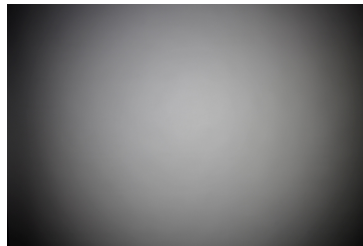

XICATO

LED XOB 14.5 mm
 FWHM / FWTM 58.0° / 94.0°
 Efficiency 76 %
 Peak intensity 0.8 cd/lm
 LEDs/each optic 1
 Light colour White
 Required components:
 F15859_HEKLA-SOCKET-I
 C13723_MIRELLA-RZL

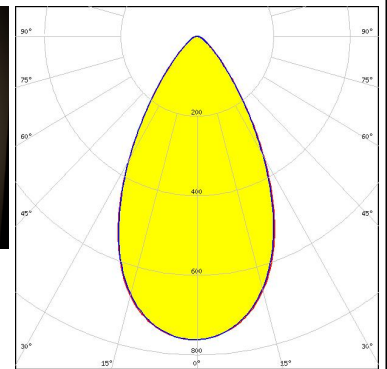
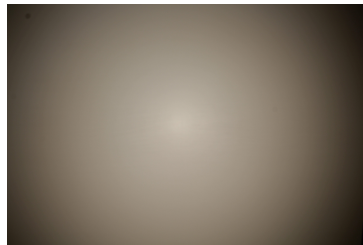

XICATO

LED XOB 14.5 mm
 FWHM / FWTM 63.0° / 88.0°
 Efficiency 84 %
 Peak intensity 0.9 cd/lm
 LEDs/each optic 1
 Light colour White
 Required components:
 F15859_HEKLA-SOCKET-I

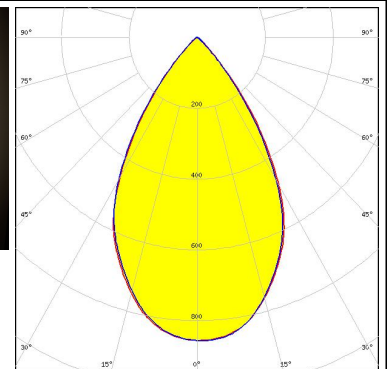
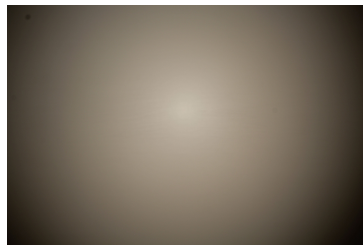

PHOTOMETRIC DATA (MEASURED):

XICATO

LED XOB 6 mm
 FWHM / FWTM 53.0° / 88.0°
 Efficiency 80 %
 Peak intensity 0.9 cd/lm
 LEDs/each optic 1
 Light colour White
 Required components:
 F15255_HEKLA-SOCKET-C
 C13723_MIRELLA-RZL

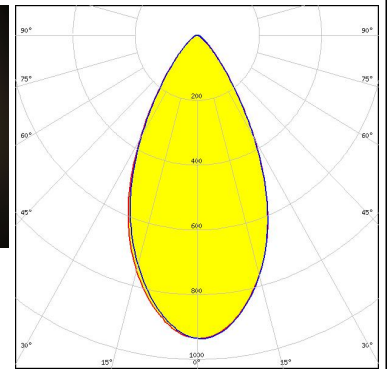
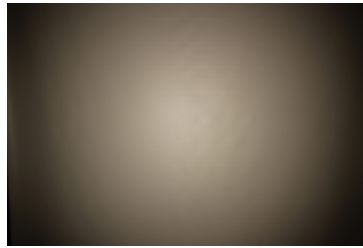

XICATO

LED XOB 6 mm
 FWHM / FWTM 44.0° / 79.0°
 Efficiency 88 %
 Peak intensity 1.3 cd/lm
 LEDs/each optic 1
 Light colour White
 Required components:
 F15255_HEKLA-SOCKET-C

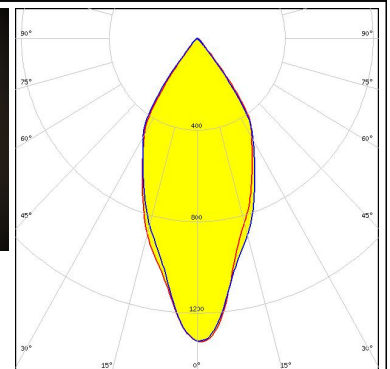
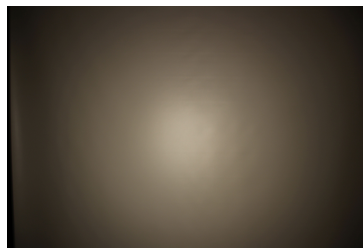

XICATO

LED XOB 9.8 mm
 FWHM / FWTM 55.0° / 90.0°
 Efficiency 81 %
 Peak intensity 0.9 cd/lm
 LEDs/each optic 1
 Light colour White
 Required components:
 F15255_HEKLA-SOCKET-C
 C13723_MIRELLA-RZL

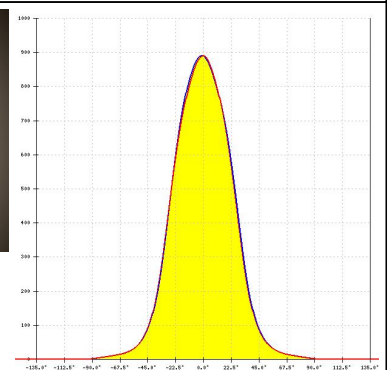
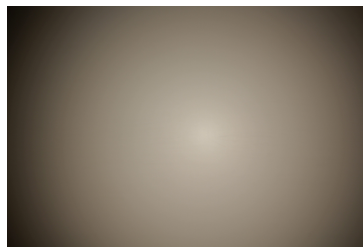





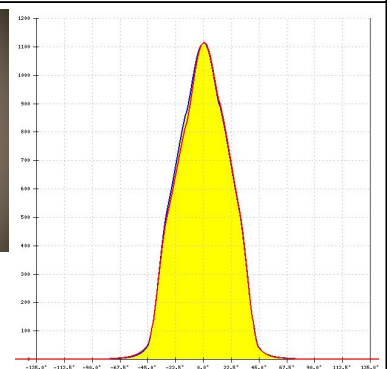
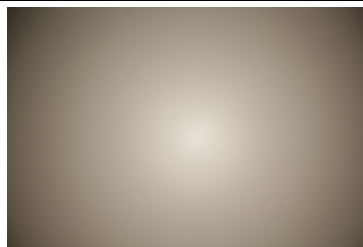

XICATO

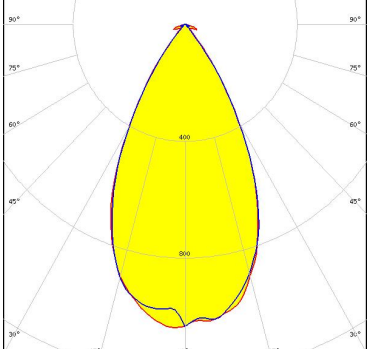
LED XOB 9.8 mm
 FWHM / FWTM 55.0° / 82.0°
 Efficiency 88 %
 Peak intensity 1.1 cd/lm
 LEDs/each optic 1
 Light colour White
 Required components:

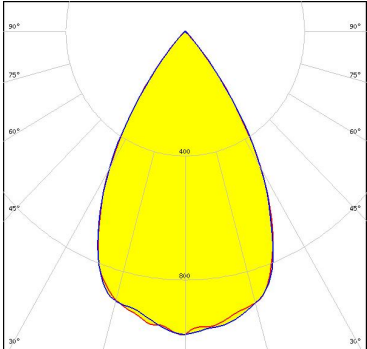

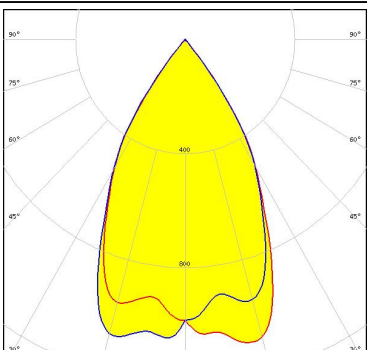
PHOTOMETRIC DATA (SIMULATED):

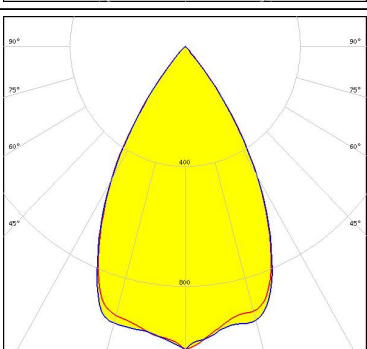
<p> bridgelux</p> <p>LED: VERO13 FWHM / FWTM: 53.0° / 78.0° Efficiency: 83 % Peak intensity: 1.1 cd/lm LEDs/each optic: 1 Light colour: White Required components: C16142_HEKLA-SOCKET-K</p>	
<p> NICHIA</p> <p>LED: COB L-Type (LES 11) FWHM / FWTM: 61.0° / 82.0° Efficiency: 88 % Peak intensity: 1 cd/lm LEDs/each optic: 1 Light colour: White Required components: F15858_HEKLA-SOCKET-H</p>	
<p> SEOL SEMICONDUCTOR</p> <p>LED: MJT COB LES 6 FWHM / FWTM: 58.0° / 78.0° Efficiency: 89 % Peak intensity: 1.1 cd/lm LEDs/each optic: 1 Light colour: White Required components: F15255_HEKLA-SOCKET-C</p>	
<p> SEOL SEMICONDUCTOR</p> <p>LED: MJT COB LES 9.8 FWHM / FWTM: 60.0° / 80.0° Efficiency: 87 % Peak intensity: 1 cd/lm LEDs/each optic: 1 Light colour: White Required components: F15255_HEKLA-SOCKET-C</p>	

GENERAL INFORMATION:

NOTE: The typical beam angle will be changed by different color, chip size and chip position tolerance. The typical total beam angle is the full angle measured where the luminous intensity is half of the peak value.

Due to use of high power COB's with this product, special attention to proper thermal design is highly recommended. LEDiL has no liability for direct, indirect or consecutive damages arising from the LEDiL products being used outside of the recommended temperature range.

MATERIALS:

As part of our continuous research and improvement processes, and to ensure the best possible quality and availability of our products, LEDiL reserves the right to change material grades without notice.

PRODUCT DATA USER AGREEMENT AND DISCLAIMER:

The measured data in the provided downloadable LEDiL Product Datasheets and Mechanical 2D-Drawings is rounded and provided as reference for planning. LEDiL Oy's optical specifications have been verified by conducting performance testing of the products in accordance with the company's quality system. The reported data are averaged results of multiple measurements with typical variation. LEDiL Oy reserves the right to without prior notification make changes and improvements to its products.

LEDiL Oy assumes neither warranty, nor guarantee nor any other liability of any kind for the contents and correctness of the provided data. The provided data has been generated with highest diligence but the provided data may in reality not represent the complete possible variation range of all intrinsic parameters. Therefore, in certain cases a deviation from the provided data could occur.

LEDiL Oy reserves the right to undertake technical changes of its products without further notification which could lead to changes in the provided data. LEDiL Oy assumes no liability of any kind for the possible deviation from any provided data or any other damage resulting from the usage of the provided data.

The user agrees to this disclaimer and user agreement with the download or usage of the provided files.

LEDiL Oy

Joensuunkatu 13
FI-24240 SALO
Finland

LEDiL Inc.

228 West Page Street
Suite D
Sycamore IL 60178
USA

Ledil Optics Technology (Shenzhen) Co., Ltd.

405 , Block B
Casic Motor Building
Shenzhen 518057
P.R.CHINA

Local sales and technical support

[www.ledil.com/
where_to_buy](http://www.ledil.com/where_to_buy)

Shipping locations

Salo, Finland
Hong Kong, China

Distribution Partners

[www.ledil.com/
where_to_buy](http://www.ledil.com/where_to_buy)