

# ESD-R Toroidal Cores for Round Cables for Low & High Frequency (Bare, coated & with case)

## Overview

The KEMET ESD-R series solid toroidal cores are designed to use on round cables. The wide range of Manganese Zinc (MnZn) and Nickel Zinc (NiZn) options are available in bare, coated, and case types and allows for targeting of specific frequency ranges.

EMI cores are part of a family of passive components, which address the issues of noise or electromagnetic interference (EMI) in circuits or systems.

## Applications

- Consumer electronics
- Air conditioners
- Power conditioners
- Refrigerators
- Washing machines
- Industrial equipment
- Medical equipment
- Adapters
- Computers
- Telecommunications

## Benefits

- MnZn  $\leq$  10 MHz (AM band range) and NiZn  $\leq$  300 MHz (FM band range) options available
- Solid construction
- Bare, coated, and case types available
- Wide range of products available

### Bare Type



### Coated Type



### Case Type



## Part Number System

ESD-	R-	10	D
Series	Shape Type	Core Size Outer Dimension Code (mm)	Internal Management Code
ESD-	Ring	See Table 1	

## Turns and Impedance Characteristics

When the desired performance of an EMI core cannot be obtained with a single pass through the core, the impedance characteristics can be changed with multiple turns.

A turn is counted by the number of lead-wire windings which pass through the inner hole of the core. Windings on the outside of the core do not count.

See Figure 1 for examples of one, two, and three turns.

Adding turns will result in higher impedance while also lowering the effective frequency range.

See Figure 2 for an example.

## Core Material and Effective Frequency Range

There are two ferrite material options for KEMET EMI Cores: Nickel Zinc (Ni-Zn) and Manganese Zinc (Mn-Zn). Each core material has a different resistance and effective frequency range. The MnZn core material has a lower resistance compared to the Ni-Zn; therefore, adequate insulation is required before use.

The Ni-Zn core material is typically effective for frequencies in the MHz band range such as the FM-band, while the Mn-Zn core material is typically effective for the kHz band range such as the AM-band. See Figure 3.

It is recommended to measure the actual frequency range effectiveness in the target application.

Figure 1 – How to count turns

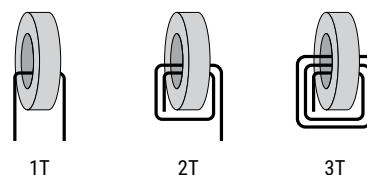

Figure 2 – Relationship between impedance and turn count. (Representative example: ESD-R-16C)

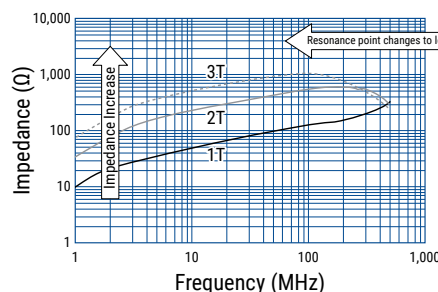
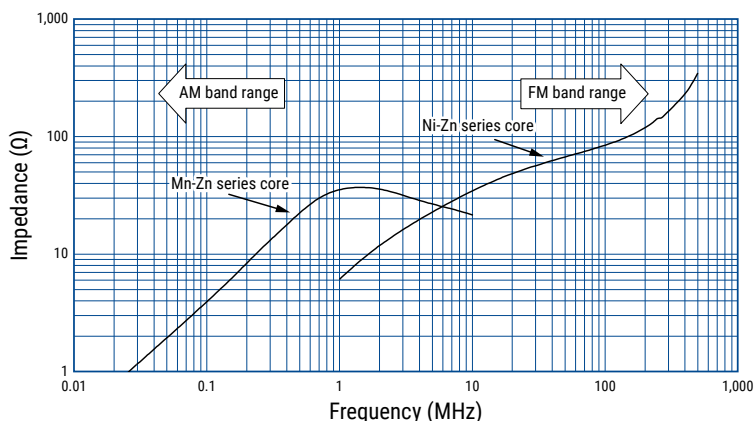

Figure 3 – Effective band range of Mn-Zn and Ni-Zn ferrite core material. (Representative example, measured with same-dimension ring core)



## Magnetic Permeability of Ferrite Material

In order to achieve most efficient noise reduction, it is important to select the material according to the target frequency band. Depending on its magnetic permeability, a particular ferrite material will be effective in a certain frequency band. A schematic representation of the relationship between the magnetic permeability of each material and the corresponding effective band range is shown in Figure 1. Materials with higher magnetic permeability are effective in the lower frequency range, while those with lower magnetic permeability are effective in the higher frequency range. Thus, Mn-Zn products are mainly used for reducing conduction noise, while Ni-Zn products are commonly used for radiation noise countermeasures.

The effective frequency range varies depending on core shape, size and number of windings. This frequency dependence of the magnetic permeability as shown in the figure serves for reference purposes only and it should be tested on the actual device to determine its effectiveness.

S18H, S15H, 10H, 7H, 5H, 1400L and 700L are KEMET's proprietary ferrite material names. Other materials can also be available on request.

Figure 4 - Relationship between the magnetic permeability of each material and its effective frequency range

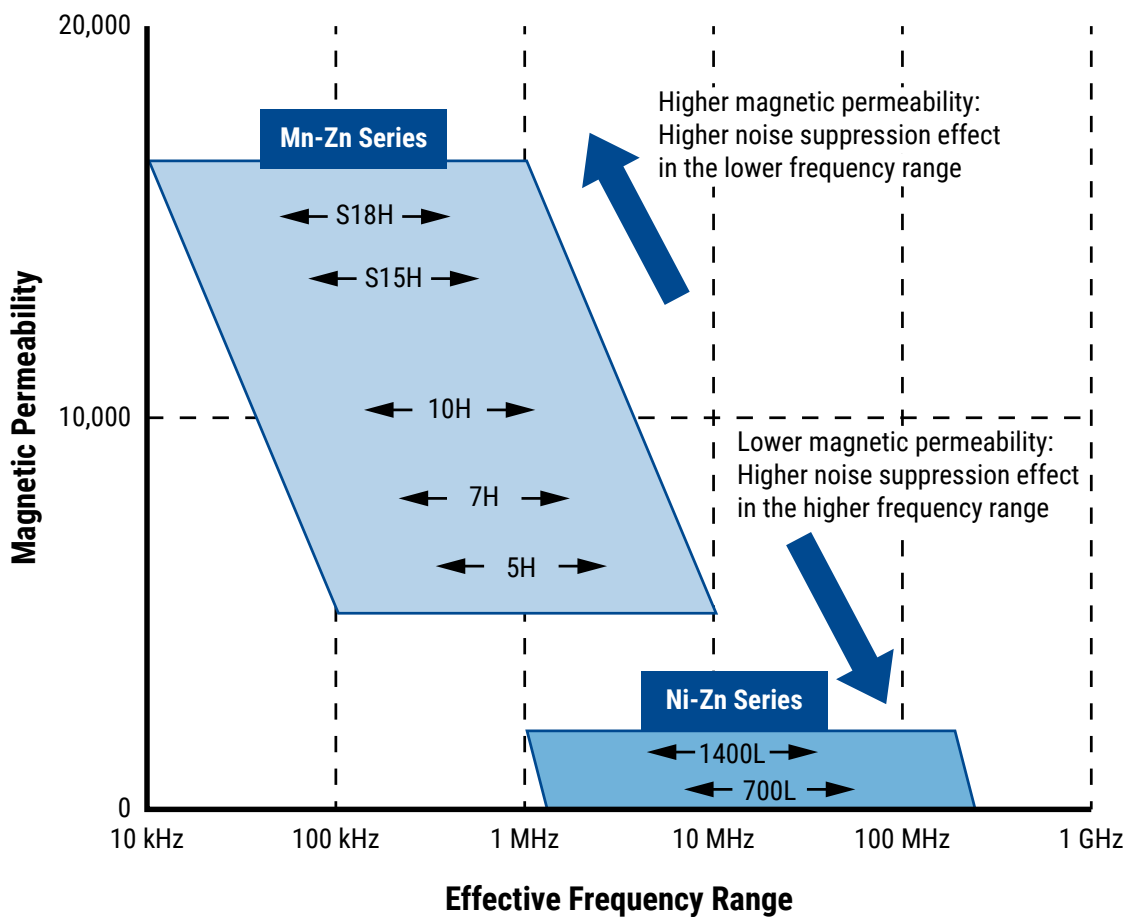

## Environmental Compliance

All KEMET EMI cores are RoHS compliant.



## Dimensions – Millimeters

Bare and Coated Types

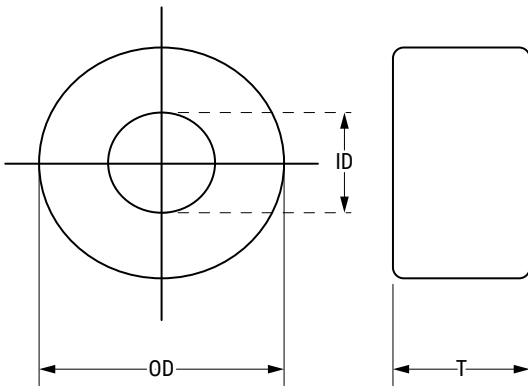

Case Type

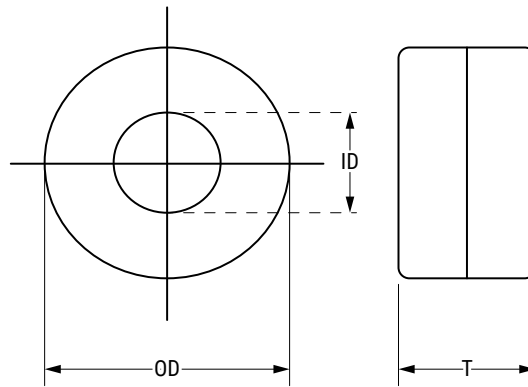

See Table 1 for dimensions

## Installation Example

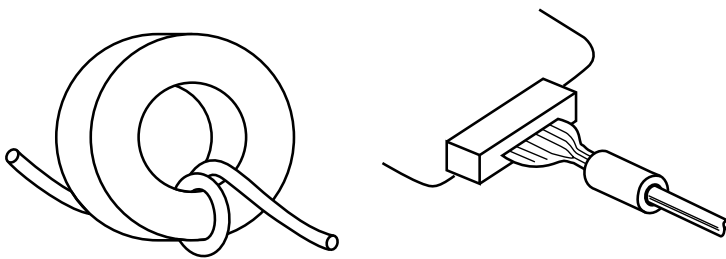

## Performance Characteristics

Item	Performance Characteristics
Operating temperature	Bare and coated: -25°C to +85°C Case : -25°C to +60°C
Frequency range	Low frequency and high frequency
Outer diameter	9.5 – 61.0 mm
Inner diameter	5.0 – 36.0 mm
Thickness	3.0 – 28.8 mm
Type	Bare, coated, and case
Case flame resistant rating	UL94 V-2
Material	MnZn 5H and NiZn 700L

**Table 1 – Ratings & Part Number Reference**

Part Number	Dimensions (mm)			Weight (g)	Type	Color	Compatible Toroid Core (Bare Type)	Frequency Range <sup>1</sup>		Material	
	OD	ID	T					≤ 10 MHz (AM band range)	≤ 300 MHz (FM band range)	MnZn	NiZn
ESD-R-10D	9.5 ±0.5	5.0 ±0.5	10.0 ±0.5	2.5	Bare	–	–		X	–	700L
ESD-R-10E	10.0 ±0.5	5.0 ±0.4	5.0 ±0.4	1.5	Bare	–	–		X	–	700L
ESD-R-10S	10.5 ±0.8	5.5 ±0.8	20.0 ±0.8	6.3	Bare	–	–		X	–	700L
ESD-R-12C	11.8 ±0.7	7.3 ±0.8	15.0 ±0.7	5.0	Bare	–	–		X	–	700L
ESD-R-12E	11.8 ±0.7	7.3 ±0.7	8.0 ±0.7	2.7	Bare	–	–		X	–	700L
ESD-R-12F	12.0 ±0.5	8.5 ±0.5	15.0 ±0.5	4.1	Bare	–	–		X	–	700L
ESD-R-12S	12.0 ±0.5	7.0 ±0.4	5.5 ±0.4	2.1	Bare	–	–		X	–	700L
ESD-R-14C	14.0 ±0.7	7.0 ±0.7	3.0 ±0.7	1.7	Bare	–	–		X	–	700L
ESD-R-14E	14.0 ±0.6	10.0 ±0.6	8.0 ±0.5	3.1	Bare	–	–		X	–	700L
ESD-R-14S	14.3 ±0.5	6.3 ±0.5	28.5 ±0.8	17.1	Bare	–	–		X	–	700L
ESD-R-15C-1	15.0 ±0.5	10.5 ±0.5	12.0 ±0.5	5.3	Bare	–	–		X	–	700L
ESD-R-16	15.8 ±0.6	11.6 ±0.6	8.4 ±0.6	3.6	Bare	–	–	X		5H	–
ESD-R-16C	16.0 ±0.7	9.0 ±0.7	17.0 ±0.7	11.2	Bare	–	–		X	–	700L
ESD-R-17S	17.5 ±0.5	9.5 ±0.3	28.5 ±0.5	24.4	Bare	–	–		X	–	700L
ESD-R-18SD	18.0 ±0.5	10.0 ±0.5	6.0 ±0.5	5.1	Bare	–	–		X	–	700L
ESD-R-19S	18.5 ±1.0	10.0 ±1.0	10.0 ±1.0	10.4	Bare	–	–	X		5H	–
ESD-R-19SD	18.5 ±1.0	10.0 ±1.0	10.0 ±1.0	10.0	Bare	–	–		X	–	700L
ESD-R-22SD	22.5 ±0.7	13.8 ±0.5	6.4 ±0.5	7.8	Bare	–	–		X	–	700L
ESD-R-25SD	25.0 ±0.5	15.0 ±0.5	12.0 ±0.3	18.5	Bare	–	–		X	–	700L
ESD-R-25S	25.0 ±0.8	15.0 ±0.8	12.0 ±0.8	18.5	Bare	–	–	X		5H	–
ESD-R-26S	26.0 ±0.5	13.0 ±0.3	28.5 ±0.5	53.3	Bare	–	–		X	–	700L
ESD-R-27S	27.0 ±0.8	19.0 ±0.8	15.0 ±0.5	21.3	Bare	–	–	X		10H	–
ESD-R-28C	28.0 ±0.8	16.0 ±0.5	13.0 ±0.6	27.3	Bare	–	–		X	–	700L
ESD-R-31C	31.0 ±0.8	19.0 ±0.5	8.0 ±0.5	18.1	Bare	–	–		X	–	700L
ESD-R-38D	38.1 ±1.0	19.0 ±0.7	12.7 ±0.7	53.0	Bare	–	–	X		5H	–
ESD-R-47S	47.0 ±1.0	27.0 ±0.8	15.0 ±0.5	83.7	Bare	–	–	X		5H	–
ESD-R-57D	57.0 ±1.5	36.0 ±1.5	20.0 ±0.7	139.1	Bare	–	–		X	–	700L
ESD-R-57S	57.0 ±1.5	36.0 ±1.0	20.0 ±0.5	139.1	Bare	–	–	X		5H	–
Part Number	OD	ID	T	(g)	Type	Color	Compatible Toroid Core (Bare Type)	≤ 10 MHz (AM band range)	≤ 300 MHz (FM band range)	MnZn	NiZn
	Dimensions			Weight				Frequency Range <sup>1</sup>		Material	

<sup>1</sup> Frequency range is for reference only. Please test with actual device before use.

\* Other sizes available on request. Please contact KEMET.

**Table 1 – Ratings & Part Number Reference cont.**

Part Number	Dimensions (mm)			Weight (g)	Type	Color	Compatible Toroid Core (Bare Type)	Frequency Range <sup>1</sup>		Material	
	OD	ID	T					≤ 10 MHz (AM band range)	≤ 300 MHz (FM band range)	MnZn	NiZn
ESD-R-12C-2	12.0 ±0.7	7.3 ±0.7	15.3 ±0.7	5.0	Coated	Blue	–		X	–	1400L
ESD-R-12CM	12.0 ±0.5	7.0 ±0.5	15.0 ±0.7	5.0	Coated	Gray	ESD-R-12C		X	–	700L
ESD-R-14A	15.0 Maximum	6.2 Minimum	3.5 Maximum	1.8	Coated	Green	–	X		5H	–
ESD-R-14C-2	14.0 ±0.5	7.0 ±0.5	3.0 ±0.5	1.7	Coated	Blue	ESD-R-14C		X	–	700L
ESD-R-15C	15.2 ±0.5	10.5 ±0.5	12.5 ±0.5	5.3	Coated	Blue	ESD-R-15C-1		X	–	700L
ESD-R-17S-1	17.7 ±0.5	9.4 ±0.3	28.8 ±0.5	24.4	Coated	Blue	ESD-R-17S		X	–	700L
ESD-R-19E-1	19.0 ±0.5	10.7 ±0.5	5.3 ±0.5	6.0	Coated	Blue	–		X	–	700L
ESD-R-25D-8	25.0 ±0.5	15.0 ±0.5	8.0 ±0.5	12.9	Coated	Blue	–		X	–	700L
ESD-R-25L-A	25.3 ±0.8	15.1 ±0.8	12.1 ±0.8	19.4	Coated	Blue	ESD-R-25SD		X	–	700L
ESD-R-25MK	25.3 ±0.6	14.8 ±0.6	12.3 ±0.6	21.0	Coated	–	ESD-R-25S	X		5H	–
ESD-R-28C-1	28.2 ±0.8	15.8 ±0.5	13.2 ±0.6	28.3	Coated	Blue	–		X	–	700L
ESD-R-31C-1	32.0 Maximum	18.5 Minimum	9.0 Maximum	18.5	Coated	Green	ESD-R-31C		X	–	700L
ESD-R-31-P	32.0 Maximum	19.0 Minimum	15.8 Maximum	32.2	Coated	Green	–	X		5H	–
ESD-R-38-P	39.5 Maximum	18.0 Minimum	14.0 Maximum	52.8	Coated	Green	–	X		5H	–
ESD-R-47-P	48.5 Maximum	26.0 Minimum	16.0 Maximum	84.8	Coated	Green	–	X		5H	–
ESD-R-57-P	59.0 Maximum	34.0 Minimum	21.0 Maximum	140.9	Coated	Green	–	X		5H	–
ESD-R-12D	12.9 ±1.0	6.0 ±1.0	6.4 ±1.0	2.4	Case	Black	ESD-R-12S		X	–	700L
ESD-R-19	19.0 ±1.0	9.0 ±1.0	11.0 ±1.0	11.1	Case	White	ESD-R-19S	X		5H	–
ESD-R-19D	19.0 ±1.0	9.0 ±1.0	11.0 ±1.0	10.7	Case	Black	ESD-R-19SD		X	–	700L
ESD-R-25	26.0 ±1.0	14.0 ±1.0	15.0 ±1.0	20.4	Case	White	ESD-R-25S	X		5H	–
ESD-R-25D	26.0 ±1.0	14.0 ±1.0	15.0 ±1.0	20.4	Case	Black	ESD-R-25SD		X	–	700L
ESD-R-25D-1	26.0 ±1.0	14.0 ±1.0	15.0 ±1.0	21.0	Case	Black with yellow tape	ESD-R-25SD		X	–	700L
ESD-R-38	39.0 ±0.8	17.5 ±0.8	14.0 ±0.8	55.3	Case	White	ESD-R-38D	X		5H	–
ESD-R-38-1	39.0 ±1.0	17.5 ±1.0	14.0 ±1.0	56.0	Case	White with yellow tape	ESD-R-38D	X		5H	–
ESD-R-38C-1	39.0 ±1.0	17.5 ±1.0	14.0 ±1.0	55.5	Case	White with black tape	–		X	–	700L
ESD-R-38SA	39.0 ±0.8	17.5 ±0.8	14.0 ±0.8	56.0	Case	White	–	X		10H	–
ESD-R-47	48.0 ±1.0	25.5 ±1.0	16.0 ±1.0	84.4	Case	White	–	X		5H	–
ESD-R-47-1	50.0 Maximum	23.0 Minimum	18.0 Maximum	90.0	Case	White with yellow tape	ESD-R-47S	X		5H	–
ESD-R-47D-1	48.0 ±1.0	25.5 ±1.0	16.0 ±1.0	84.6	Case	White with black tape	–		X	–	700L
ESD-R-57	61.0 Maximum	32.4 ±1.0	24.0 Maximum	150.1	Case	White	–	X		5H	–
ESD-R-57A-1	61.0 Maximum	32.4 ±1.0	24.0 Maximum	150.1	Case	White with yellow tape	ESD-R-57S	X		5H	–
ESD-R-57D-1	61.0 Maximum	32.4 ±1.0	24.0 Maximum	154.2	Case	White with black tape	–		X	–	700L
Part Number	OD	ID	T	(g)	Type	Color	Compatible Toroid Core (Bare Type)	≤ 10 MHz (AM band range)	≤ 300 MHz (FM band range)	MnZn	NiZn
	Dimensions			Weight				Frequency Range <sup>1</sup>			

<sup>1</sup> Frequency range is for reference only. Please test with actual device before use.

\* Other sizes available on request. Please contact KEMET.

## Impedance vs. Frequency

Bare Type

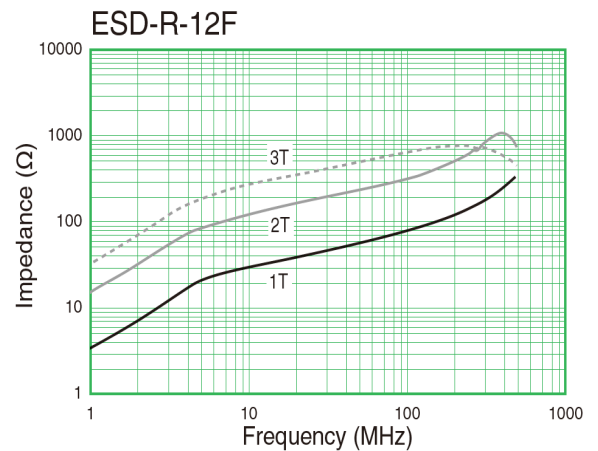
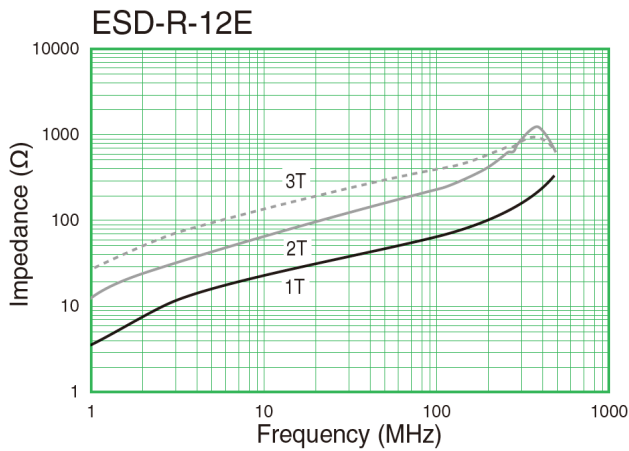
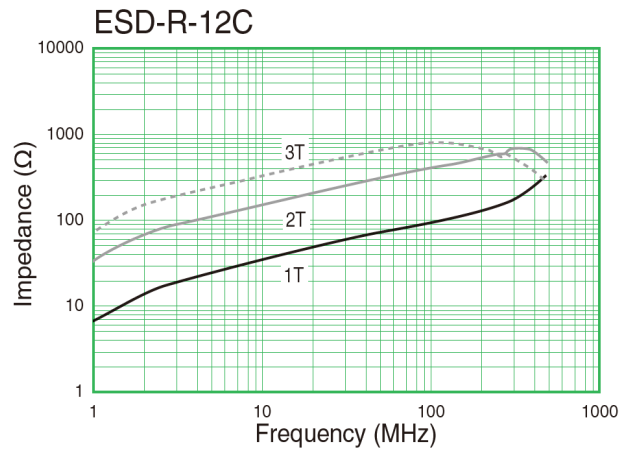
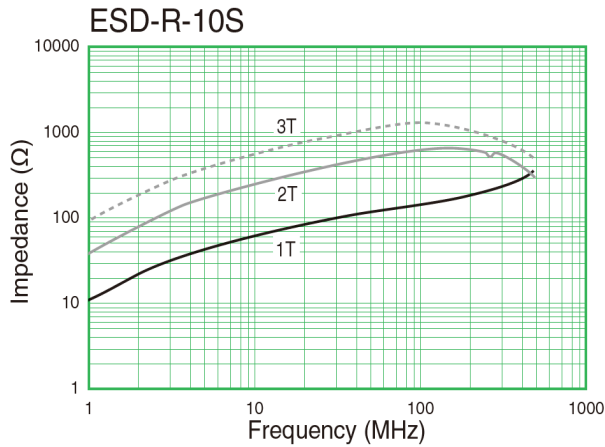
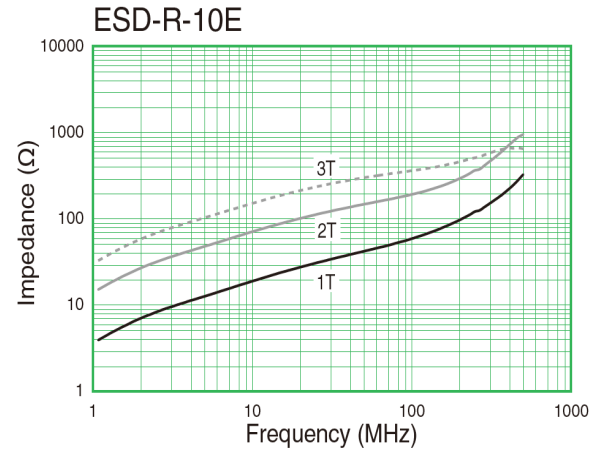
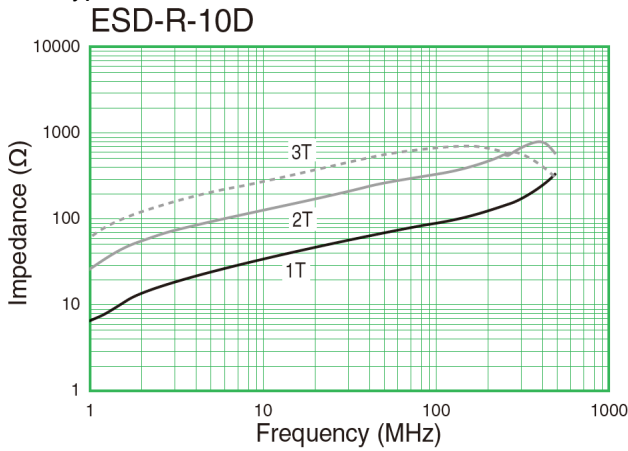

## Impedance vs. Frequency cont.

Bare Type

ESD-R-12S

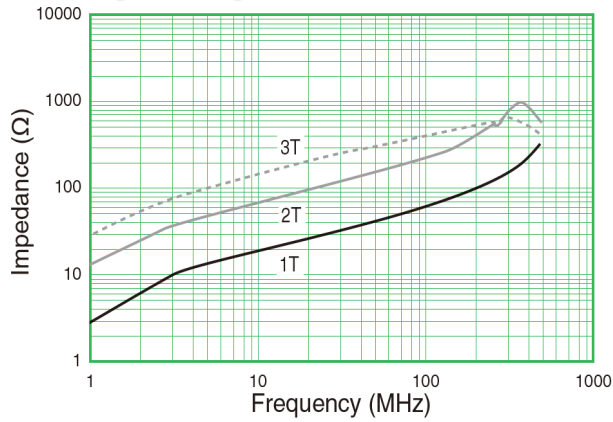

ESD-R-14C

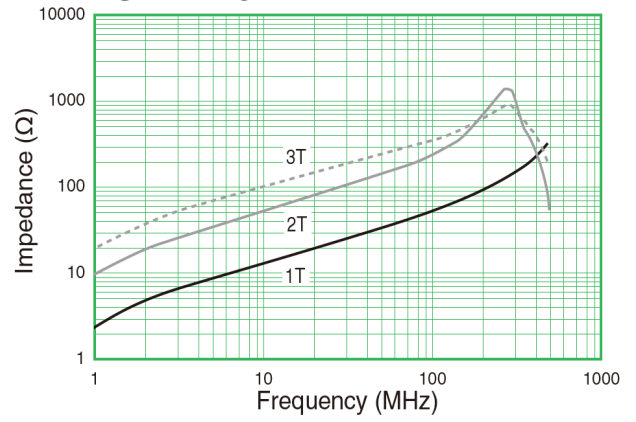

ESD-R-14E

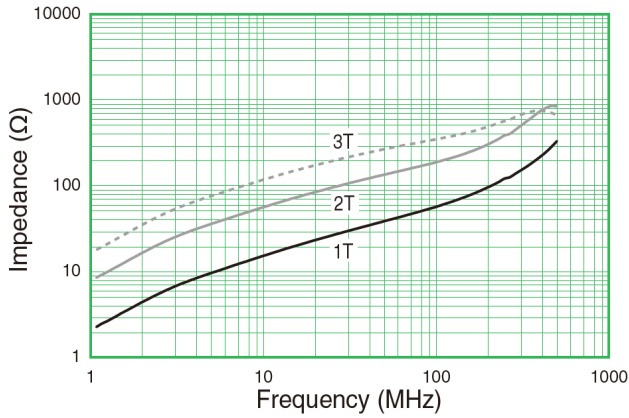

ESD-R-14S

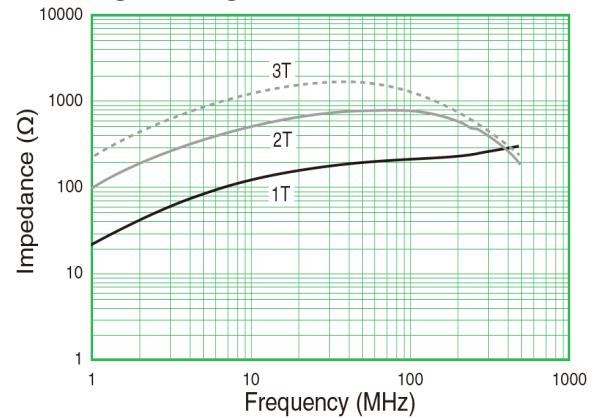

ESD-R-15C-1

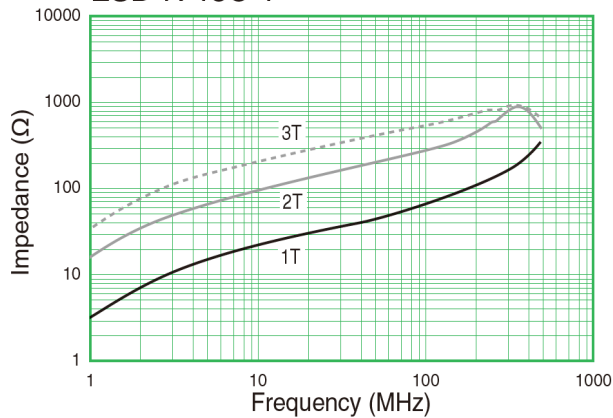

ESD-R-16

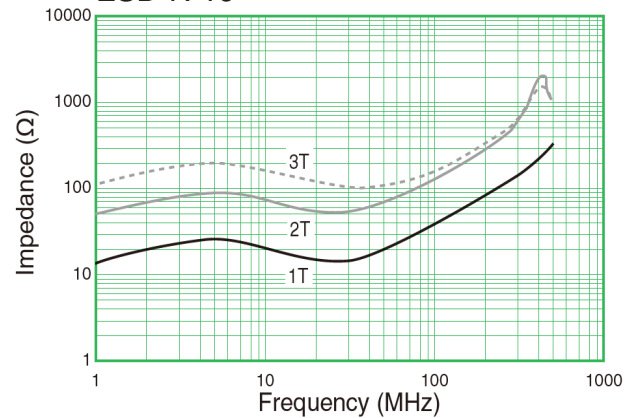



## Impedance vs. Frequency cont.

### Bare Type

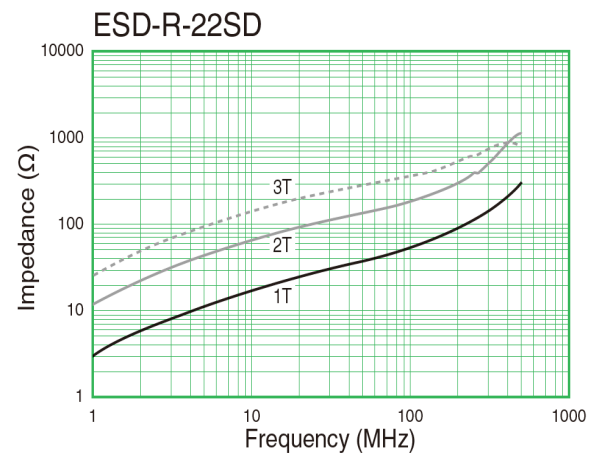
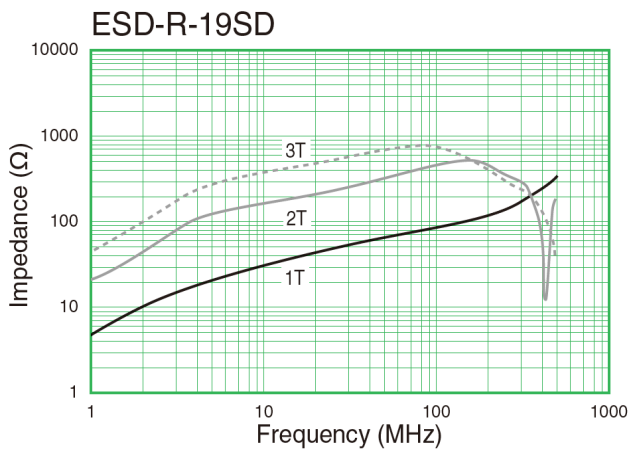
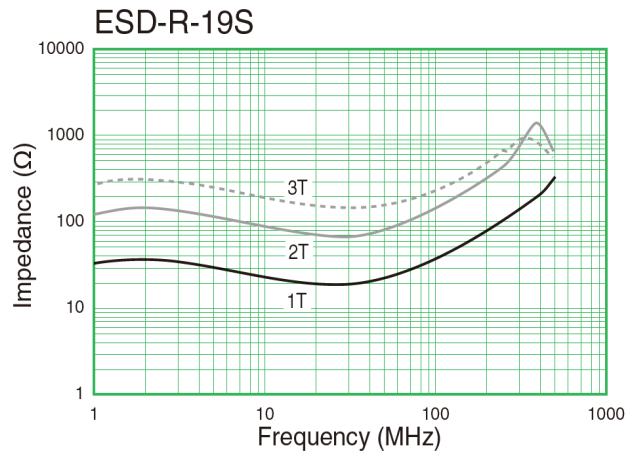
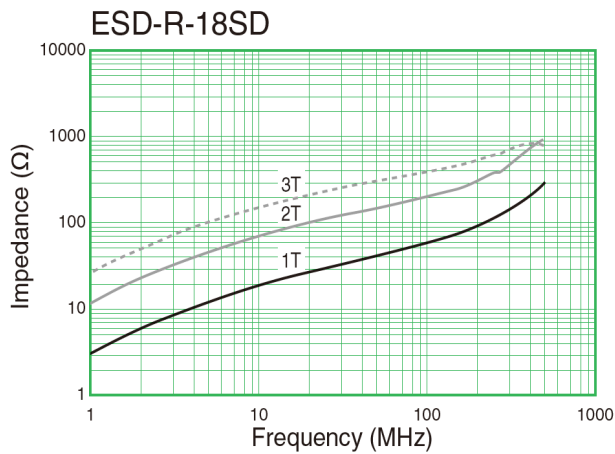
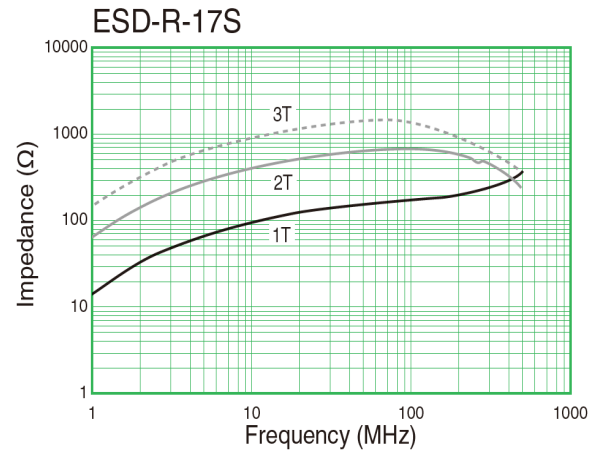
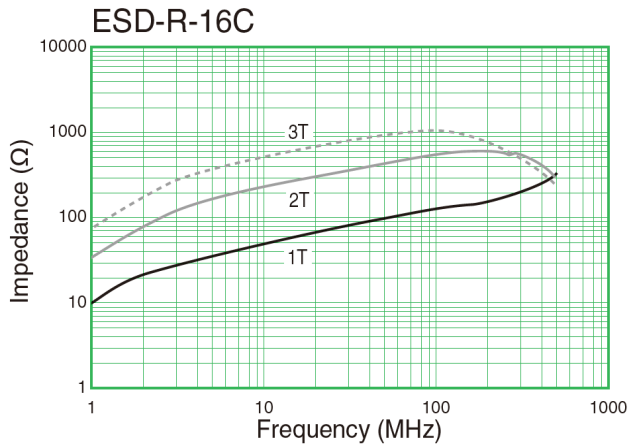

## Impedance vs. Frequency cont.

Bare Type

ESD-R-25SD

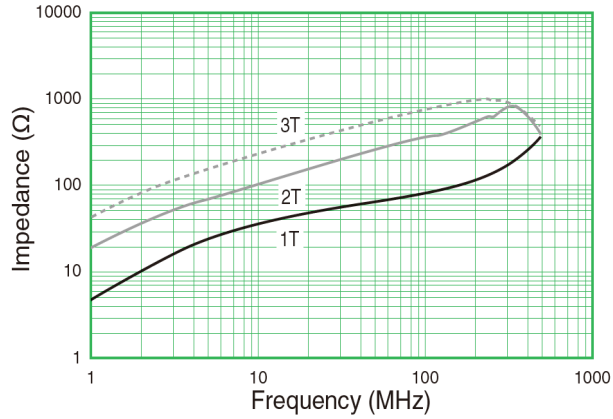

ESD-R-25S

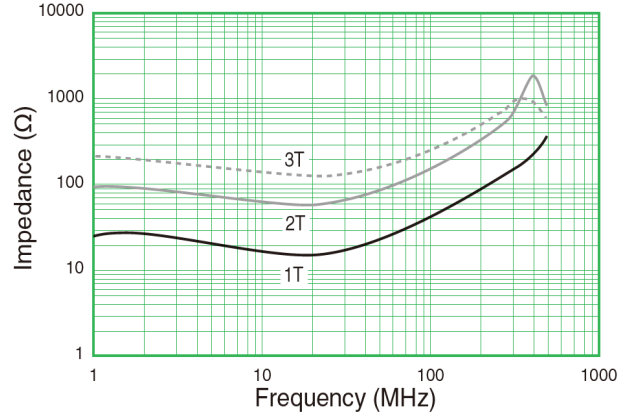

ESD-R-26S

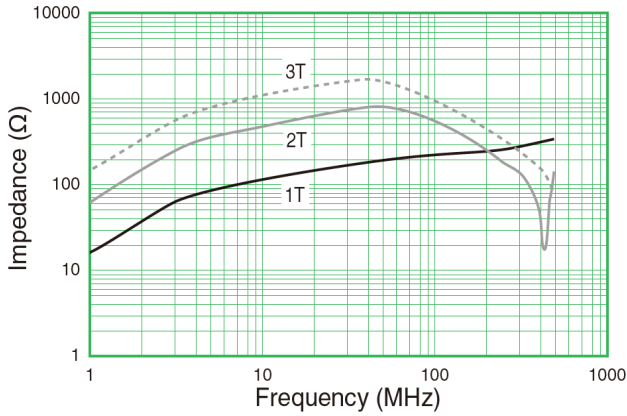

ESD-R-27S

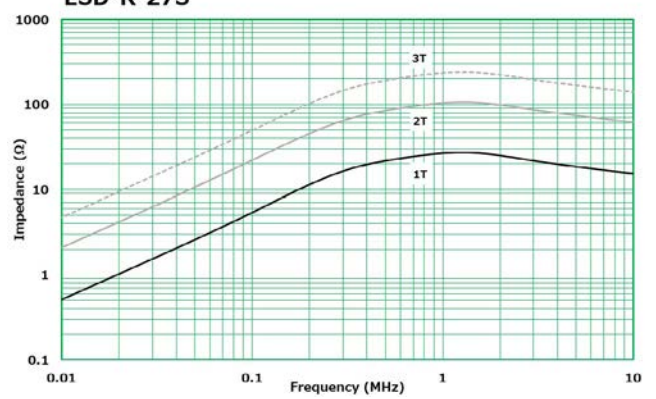

ESD-R-28C

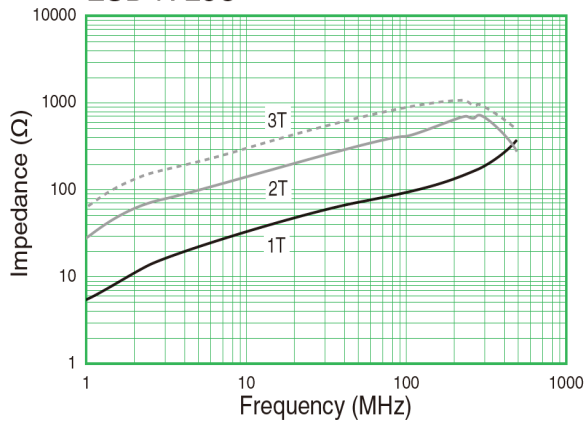

ESD-R-31C

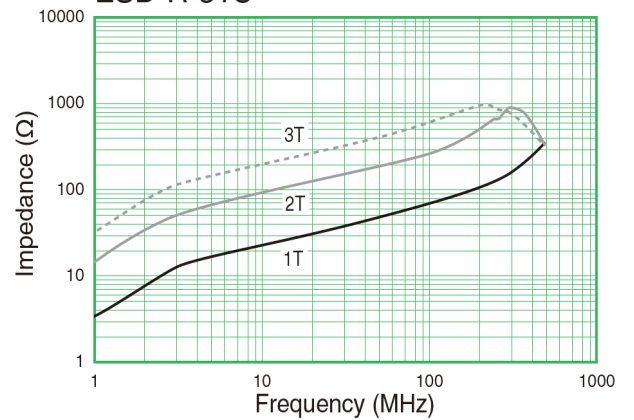

## Impedance vs. Frequency cont.

### Bare Type

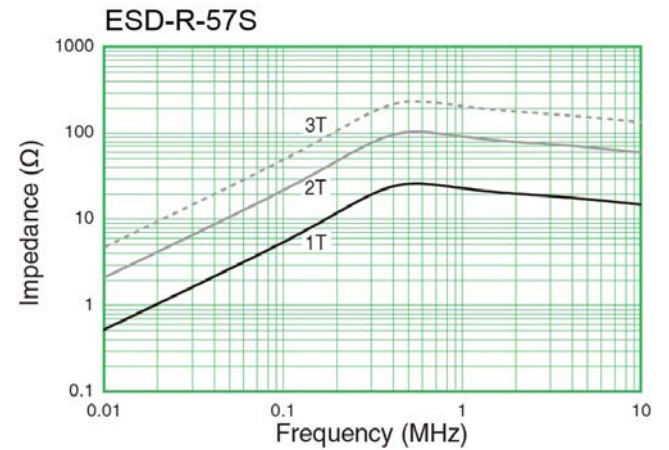
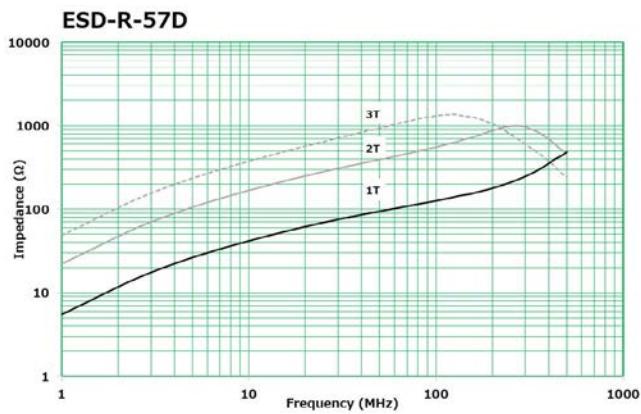
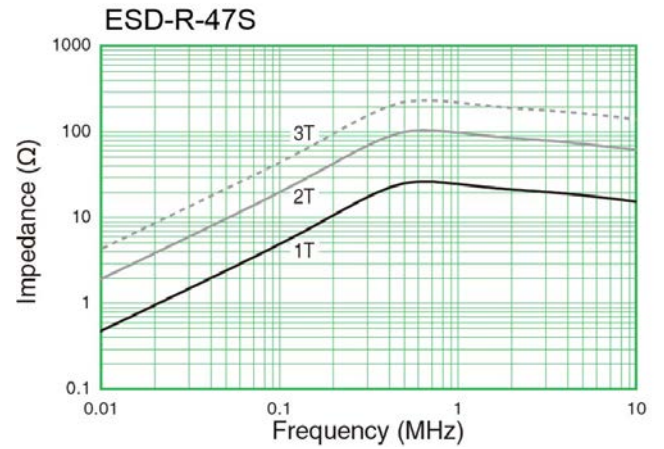
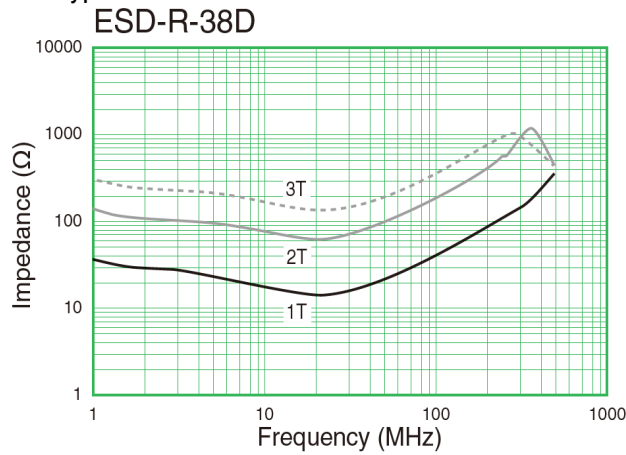

### Coated Type

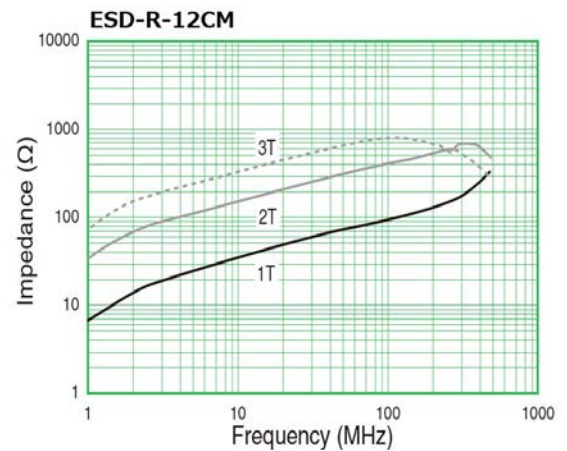
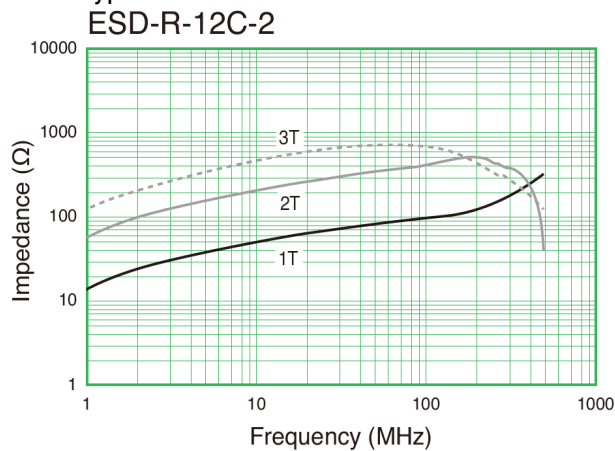

## Impedance vs. Frequency cont.

### Coated Type

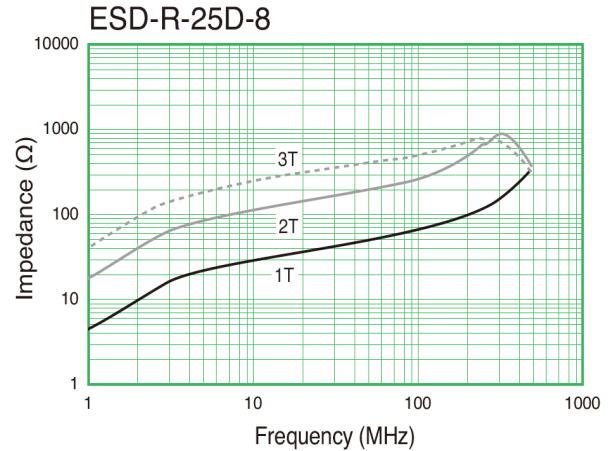
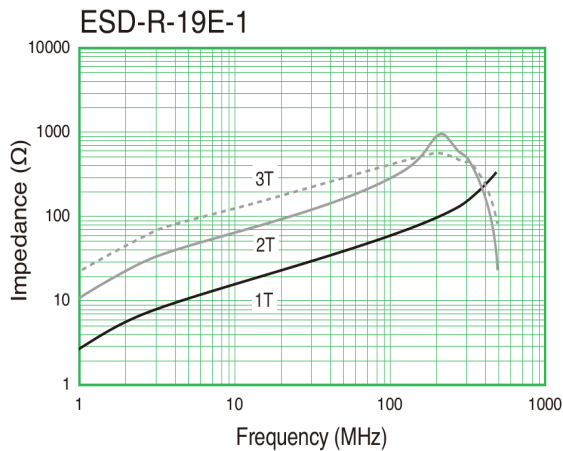
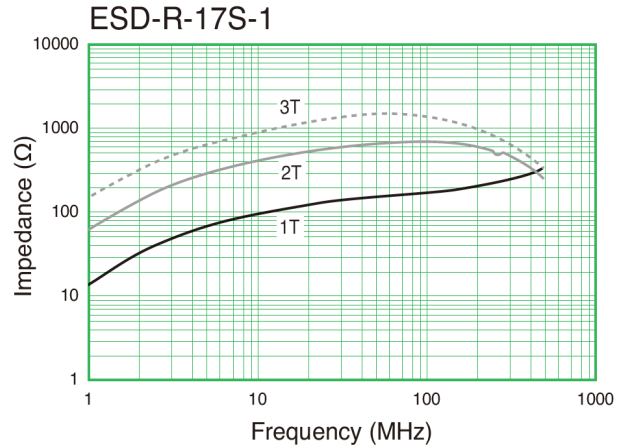
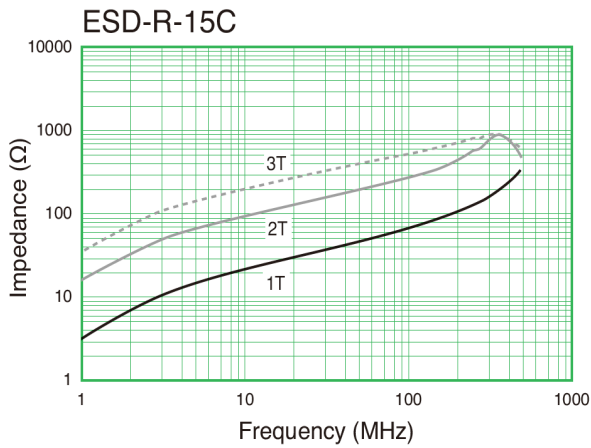
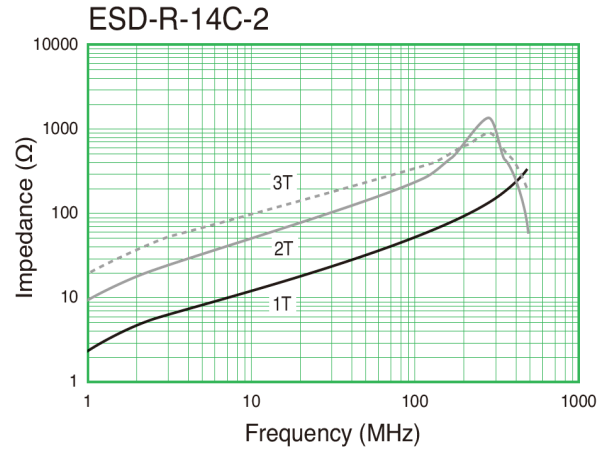
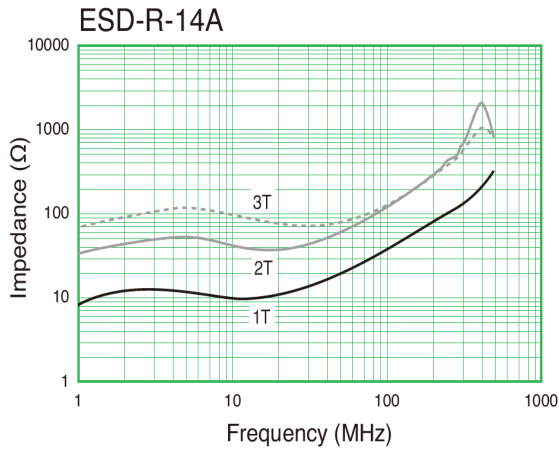

## Impedance vs. Frequency cont.

Coated Type

ESD-R-25L-A

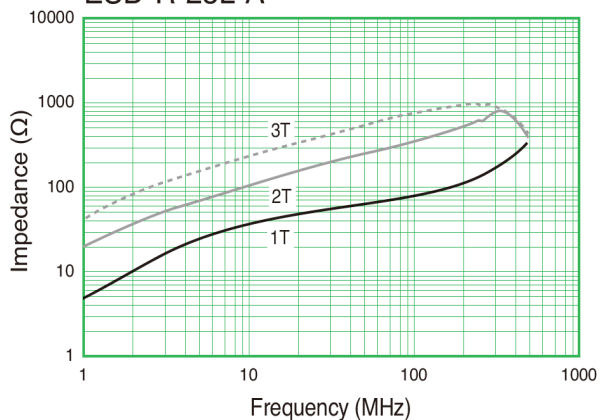

ESD-R-25MK

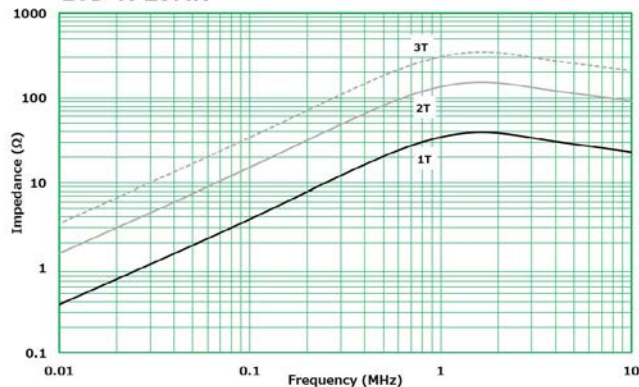

ESD-R-28C-1

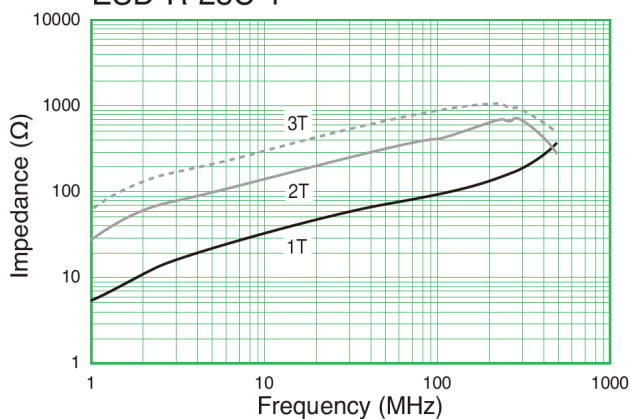

ESD-R-31C-1

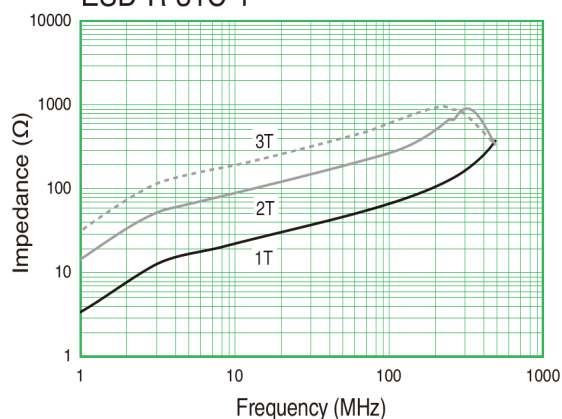

ESD-R-31-P

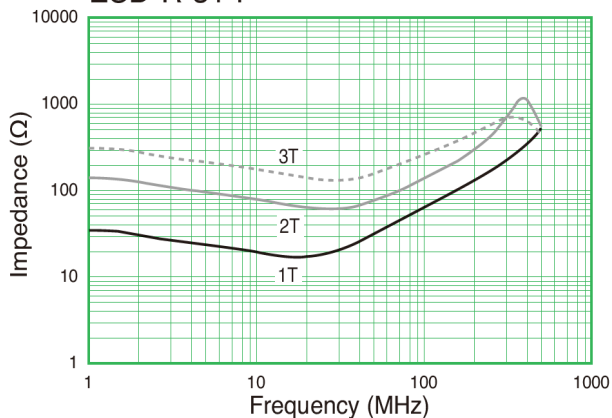

ESD-R-38-P

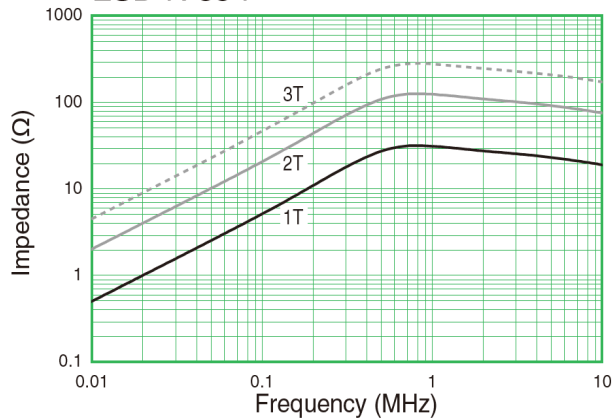



## Impedance vs. Frequency cont.

### Coated Type

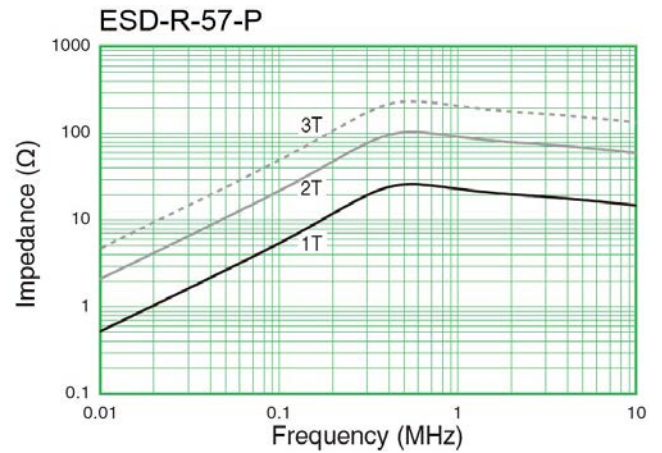
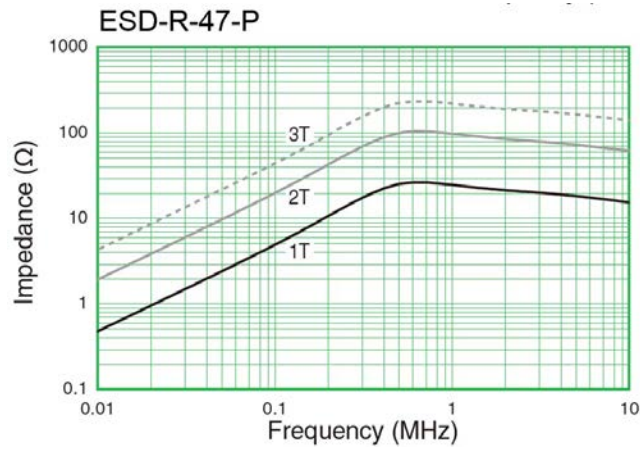

### Case Type

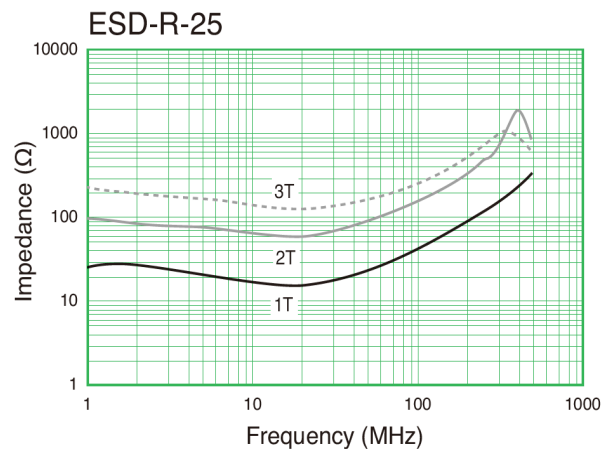
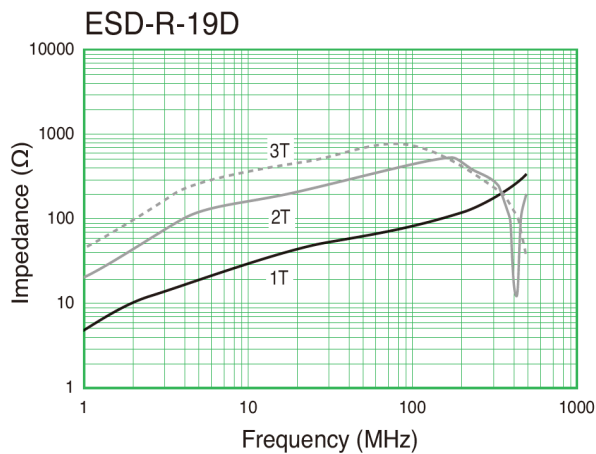
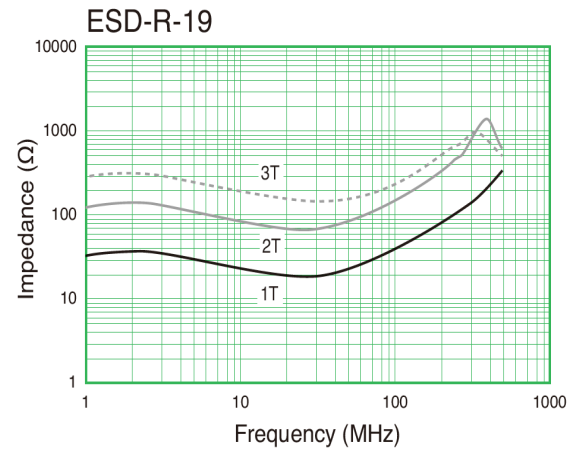
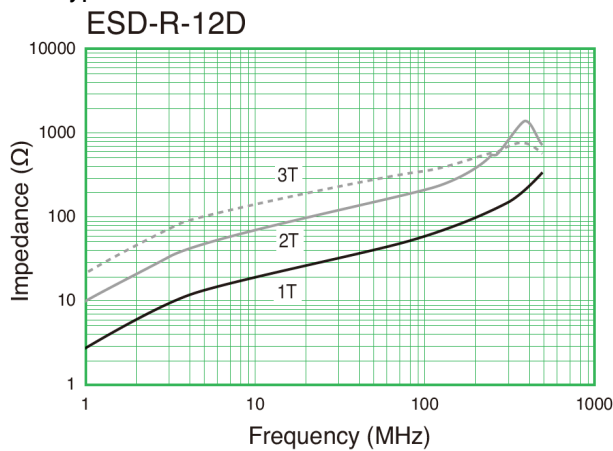

## Impedance vs. Frequency cont.

Case Type

**ESD-R-25D**

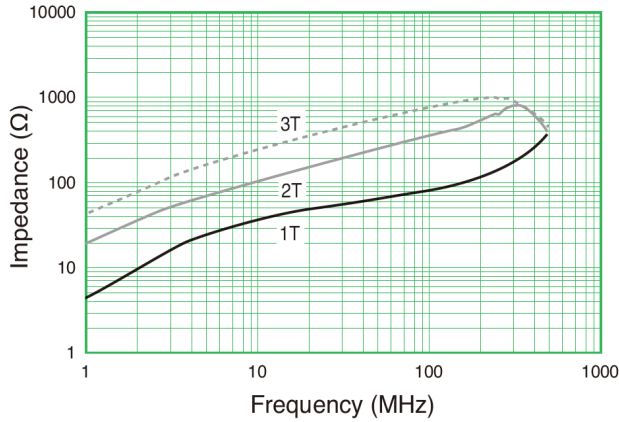

**ESD-R-25D-1**

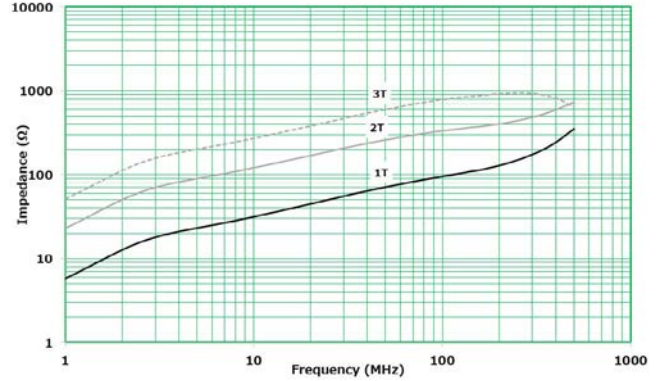

**ESD-R-38**

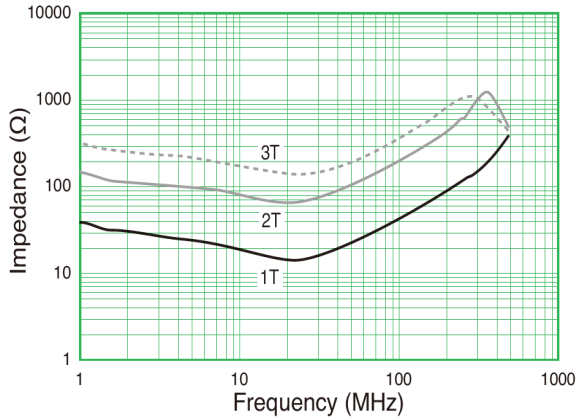

**ESD-R-38-1**

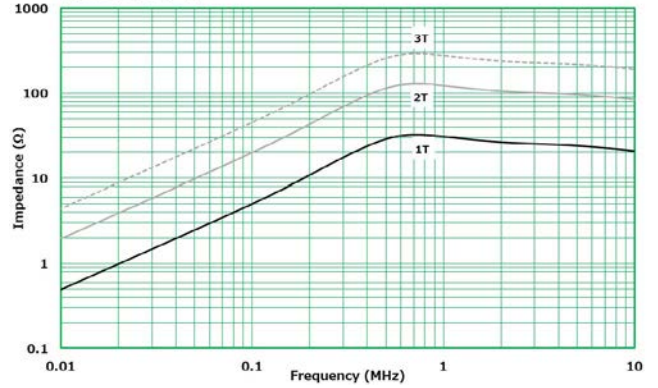

**ESD-R-38C-1**

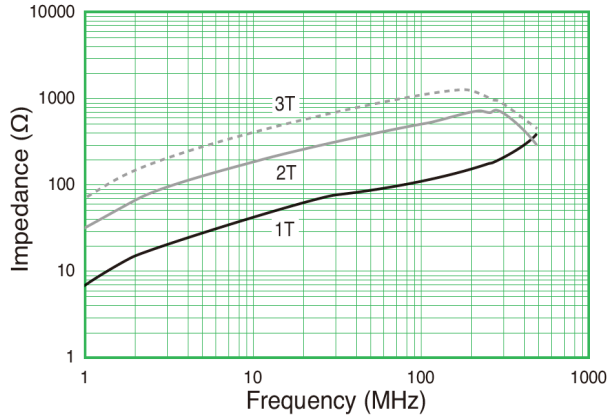

**ESD-R-38SA**

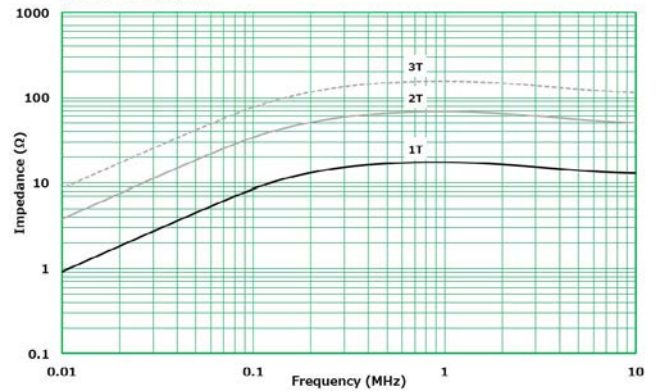

## Impedance vs. Frequency cont.

Case Type

**ESD-R-47**

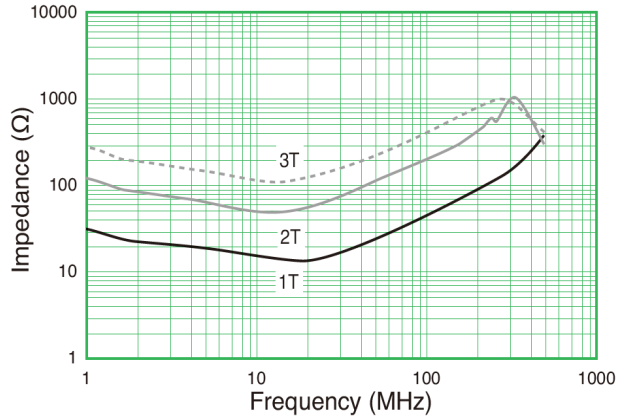

**ESD-R-47-1**

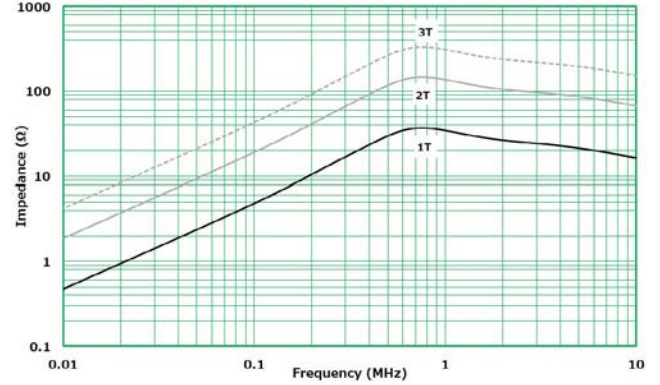

**ESD-R-47D-1**

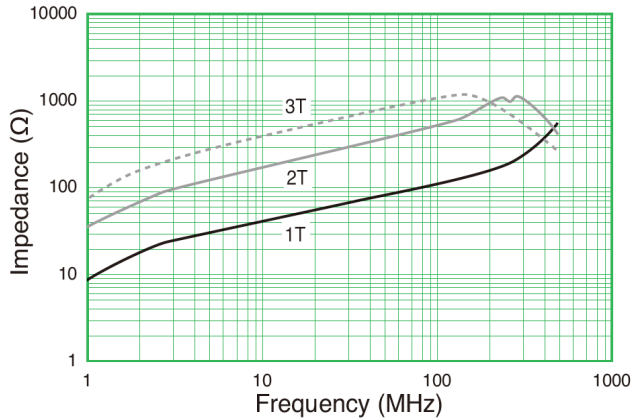

**ESD-R-57**

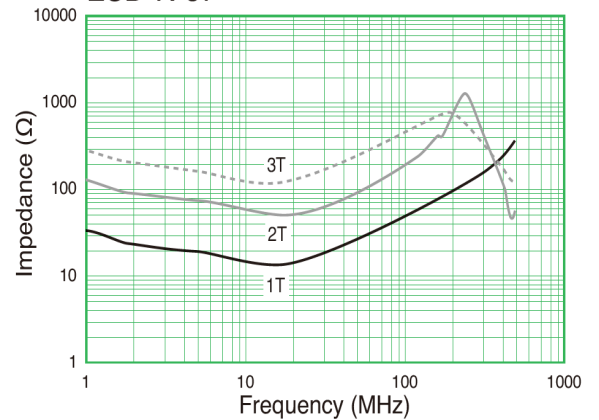

**ESD-R-57A-1**

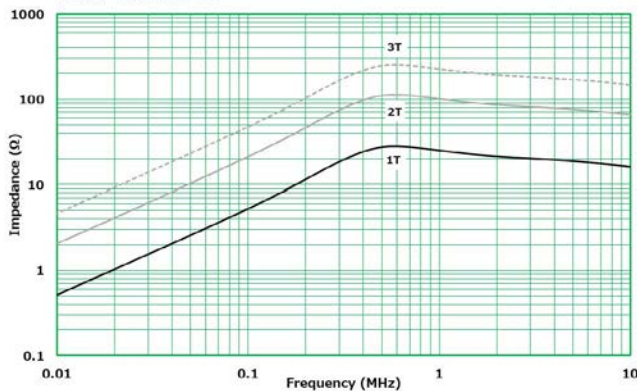

**ESD-R-57D-1**

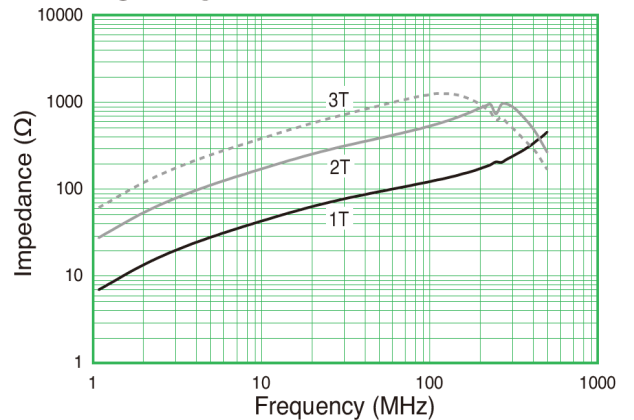



## Packaging

Part Number	Packaging Type	Pieces per Box
ESD-R-10D	Tray	3,600
ESD-R-10E		7,000
ESD-R-10S		1,260
ESD-R-12C		1,400
ESD-R-12E		1,500
ESD-R-12F		1,400
ESD-R-12S		1,500
ESD-R-14C		6,000
ESD-R-14E		2,400
ESD-R-14S		550
ESD-R-15C-1		800
ESD-R-16		780
ESD-R-16C		720
ESD-R-17S		440
ESD-R-18SD		1,664
ESD-R-19S		480
ESD-R-19SD		1,120
ESD-R-22SD		1,014
ESD-R-25SD		540
ESD-R-25S		300
ESD-R-26S		200
ESD-R-27S		300
ESD-R-28C		300
ESD-R-31C		200
ESD-R-38D		100
ESD-R-47S		75
ESD-R-57D		60
ESD-R-57S		1,400
ESD-R-12C-2		1,500
ESD-R-12CM		6,000
ESD-R-14A		800
ESD-R-14C-2		440
ESD-R-15C		800
ESD-R-17S-1		600
ESD-R-19E-1		540
ESD-R-25D-8		400
ESD-R-25L-A		300
ESD-R-25MK		200
ESD-R-28C-1		100
ESD-R-31C-1		
ESD-R-31-P		
ESD-R-38-P		
ESD-R-47-P		

## Packaging cont.

Part Number	Packaging Type	Pieces per Box
ESD-R-57-P	Tray	60
ESD-R-12D		2,000
ESD-R-19		480
ESD-R-19D		
ESD-R-25		300
ESD-R-25D		
ESD-R-25D-1		
ESD-R-38		200
ESD-R-38-1		
ESD-R-38C-1		
ESD-R-38SA		
ESD-R-47		
ESD-R-47-1		100
ESD-R-47D-1		
ESD-R-57		60
ESD-R-57A-1		
ESD-R-57D-1		

## Handling Precautions

EMI Cores should be stored in normal working environments. While the EMI Cores themselves are quite robust in other environments, avoid exposure to high temperatures, high humidity, corrosive atmospheres and long term storage for case, snap-on and split types.

KEMET recommends that maximum storage temperature not exceed 40°C and maximum storage humidity not exceed 75% relative humidity. Atmospheres should be free of chlorine, sulfur and alkali bearing compounds. Avoid also storage near strong magnetic fields as this might magnetize the product.

Temperature fluctuations should be minimized to avoid condensation or cracks on the parts. Mechanical shocks can bring to cracks as well.

## Export Control

### For customers in Japan

For products that are controlled items subject to the “Foreign Exchange and Foreign Trade Law” of Japan, the export license specified by the law is required for export.

### For customers outside Japan

EMI Core products should not be used or sold for use in the development, production, stockpiling or utilization of any conventional weapons or mass-destructive weapons (nuclear weapons, chemical or biological weapons, or missiles), or any other weapons.

## KEMET Electronics Corporation Sales Offices

For a complete list of our global sales offices, please visit [www.kemet.com/sales](http://www.kemet.com/sales).

---

### Disclaimer

All product specifications, statements, information and data (collectively, the "Information") in this datasheet are subject to change. The customer is responsible for checking and verifying the extent to which the Information contained in this publication is applicable to an order at the time the order is placed. All Information given herein is believed to be accurate and reliable, but it is presented without guarantee, warranty, or responsibility of any kind, expressed or implied.

Statements of suitability for certain applications are based on KEMET Electronics Corporation's ("KEMET") knowledge of typical operating conditions for such applications, but are not intended to constitute – and KEMET specifically disclaims – any warranty concerning suitability for a specific customer application or use. The Information is intended for use only by customers who have the requisite experience and capability to determine the correct products for their application. Any technical advice inferred from this Information or otherwise provided by KEMET with reference to the use of KEMET's products is given gratis, and KEMET assumes no obligation or liability for the advice given or results obtained.

Although KEMET designs and manufactures its products to the most stringent quality and safety standards, given the current state of the art, isolated component failures may still occur. Accordingly, customer applications which require a high degree of reliability or safety should employ suitable designs or other safeguards (such as installation of protective circuitry or redundancies) in order to ensure that the failure of an electrical component does not result in a risk of personal injury or property damage.

Although all product-related warnings, cautions and notes must be observed, the customer should not assume that all safety measures are indicated or that other measures may not be required.

*KEMET is a registered trademark of KEMET Electronics Corporation.*