



# E220 Series Quick Start Guide V3

---

## Table of Contents

<b>1.0 Terms and Conditions</b>	<b>3</b>
<b>2.0 E220 Series:</b>	<b>4</b>
<b>3.0 Setup:</b>	<b>5</b>
<b>3.1 Prerequisite</b>	<b>5</b>
<b>3.2 Available Accessories</b>	<b>6</b>
<b>4.0 Maestro Router Overview</b>	<b>7</b>
<b>4.1 LAN Panel Details</b>	<b>7</b>
<b>4.2 WAN Panel Details</b>	<b>9</b>
<b>4.3 Front Panel Details</b>	<b>10</b>
<b>5.0 Connecting Maestro Router</b>	<b>11</b>
<b>6.0 Software Configuration</b>	<b>14</b>
<b>7.0 Conformity</b>	<b>17</b>
<b>7.1 Federal Communications Commission (FCC) Compliance Statement</b>	<b>17</b>
<b>7.2 FCC RF Exposure statement</b>	<b>17</b>
<b>7.3 ISED Notice</b>	<b>17</b>
<b>7.4 ISED RF Exposure Information</b>	<b>18</b>
<b>8.0 Appendix:</b>	<b>0</b>
<b>8.1 Pin Power Cable Schematic</b>	<b>0</b>
<b>8.2 Power over Ethernet</b>	<b>1</b>
<b>8.3 RS485 wiring diagram</b>	<b>2</b>
<b>8.4 Certified antenna</b>	<b>3</b>
<b>8.5 Selection of antenna</b>	<b>3</b>

## 1.0 Terms and Conditions

- 1.1.1 This manual is written without warranty.
- 1.1.2 Maestro Wireless Solutions Ltd. reserves the right to modify or improve the product and its accessories, which can also be withdrawn without prior notice.
- 1.1.3 The company stresses the fact that the performance of the product and its accessories depend on the proper use conditions as well as the surrounding environment.
- 1.1.4 Maestro Wireless Solutions Ltd. assumes no liability for damage incurred directly or indirectly from errors, omissions or discrepancies between the router and this manual.
- 1.1.5 Every effort is made to keep the product and its software up to date and running smoothly. However, Maestro Wireless Solutions Ltd. takes no responsibility for, and will not be liable for the product or its software being temporarily unavailable due to technical issues beyond our control.
- 1.1.6 The above terms and conditions are subject to change without prior notice. The present use of this product implies that the user approves and understands all the above terms and conditions.

## 2.0 E220 Series:

**Table 1:** E220 Series compatible models

Product name	Territories / Operators	Bands	Fall-back mode	Bands	Cellular Type
E224	EMEA	3/8/20	2G	3/8	LTE cat. 1
E224	AT&T, T-Mobile	2/4/12	None	N/A	LTE cat. 1
E225 Lite	EMEA, Asia	1/8	2G	3/8	3G [1]
E225 Lite	World	1/2/5/6/8/19	2G	2/3/5/8	3G [1]
E225	EMEA, Asia	1/8	2G	3/8	3G [1]
E225	Worldwide	1/2/5/6/8/19	2G	2/3/5/8	3G [1]
E228	Verizon Wireless	4/13	None	N/A	LTE cat. 4
E228	AT&T, Rogers	2/4/5/13/17	3G [2]	2/5	LTE cat. 4
E228	Telstra, Spark	3/7/28	None	N/A	LTE cat. 4
E228	NTT Docomo	1/19/21	None	N/A	LTE cat. 4
E228	Korea, Thailand, Brazil, etc.	1/3/5/7	None	N/A	LTE cat. 4

[1] 7.2Mbps downlink; 5.76Mbps uplink; [2] 43.2Mbps downlink; 5.76Mbps uplink

**Figure 1:** E220 Series: High-speed 3G or LTE router



## 3.0 Setup:

### 3.1 Prerequisite

3.1.1 Before installing your E220 Series router, verify you have the following:

- Router Hardware with:
  - Active sim card
  - Ethernet cable
  - Wi-Fi and cellular antennas
- Computer equipped with:
  - Windows, Mac or Linux operating system.
  - Ethernet port or Wi-Fi connectivity and Internet service
  - Web browser such as Internet Explorer 8+ or Google Chrome, Mozilla Firefox or Safari to access the Maestro Web Admin Console
  - DHCP set to enable.

3.1.2 To enable DHCP, do the following:

- From the **Start** menu, select **Control Panel > Network and Sharing Center** and then select the existing connection.
- The **Network Connection Status** dialog box appears. Click **Properties** > double click **Internet Protocol Version 4 (TCP/IPv4)**.
- The **Internet Protocol Version 4 (TCP/IPv4) Properties** dialog box appears. Under the tab **General**, select **Obtain an IP address automatically** and **Obtain DNS server address automatically**.

### 3.2 Available Accessories

**Table 2:** The following accessories are available for purchase:

Item	Description
<b>Power Supply / Cable</b>	
ACC-CA30	2-pin Micro-Fit 3.0 (M) to stripped wire with 2.5 A fused, 1-metre long cable
ACC-PS20	2-pin Molex 1.2A power adapter with Euro plug 2-pin - Europe
ACC-PS21	2-pin Molex 1.2A power adapter with NEMA 2-pin plug - America
ACC-PS22	2-pin Molex 1.2A power adapter with AS3112 3-pin plug – Australia / NZ
ACC-PS23	2-pin Molex 1.2A power adapter with BS1363 3-pin plug - UK
<b>Wi-Fi Antenna</b>	
ACC-A21	5-band 2.4 / 5.8GHz dipole antenna, hinged RP-SMA (M)
<b>Cellular / GPS Antenna</b>	
ACC-A11 or ACC-A17A	5-band 850 / 900 / 1800 / 1900 / 2100MHz magnetic mount antenna, 3-meter cable, SMA (M)
ACC-A03	GPS 1575.42MHz Magnetic mount antenna, 3-meter cable, SMA (M)
ACC-A22	Ultra-wide-band 698-960 / 1575.42 / 1710-2700MHz L-shaped antenna, hinged, SMA (M)
<b>Miscellaneous</b>	
ACC-DIN	Metal DIN Rail clip
ACC-CA29	RJ45(M) to RJ45(M)-cable length=1000mm

3.2.1 For a full list of Maestro Wireless accessories, refer to: <http://www.maestro-wireless.com/accessories/>

## 4.0 Maestro Router Overview

### 4.1 LAN Panel Details

Figure 2: Maestro Router LAN Panel

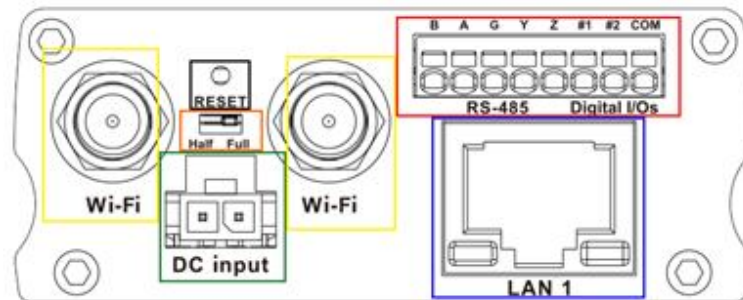

- **Yellow - Wi-Fi Connector:** RP-SMA antenna connector
- **Orange - Reset Button:** When pushed for 3 seconds the device will reset to default settings.
- **Green - DC Power Supply:** 2-pin Micro-fit 3.0 connector. Black (left) negative red (right) positive.
- **Blue - Ethernet port (LAN):** Ethernet cable connects to LAN
- **Red - RS-485 & Digital input/output ports** (see figure 3 next page):

**Figure 3:** Maestro Router LAN Panel I/O connector

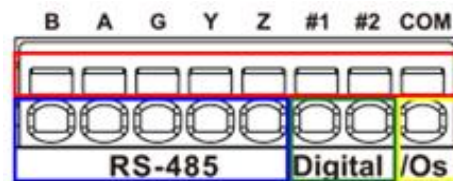

- **Red** - Top slots are release pins for bottom ports.
- **Blue** - RS-485
  - **Full-duplex:**
    - **B:** Rx –
    - **A:** Rx +
    - **G:** Common Ground
    - **Y:** Tx +
    - **Z:** Tx –
  - **Half-duplex**
    - **A&Y:** DATA +
    - **B&Z:** DATA –
    - **G:** Common Ground
- **Green** - DIO Ports configurable as input or output, 20 AWG (recommended).
  - **Input detection:** 5V, max. 48V
  - **Output:** Open collector, max. current 200mA
- **Yellow** - Ground for both DIOs



## 4.2 WAN Panel Details

Figure 4: Maestro Router WAN Panel

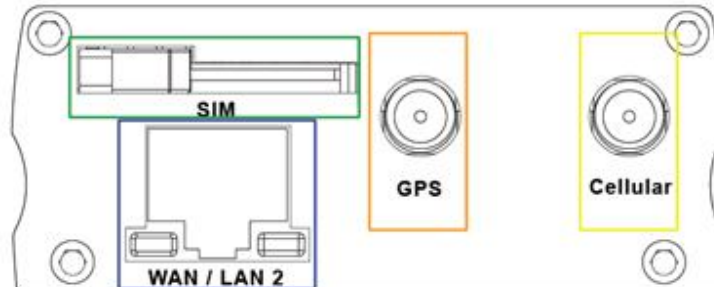

- **Blue - Ethernet port:** Can switch from WAN to LAN
  - **Supports PoE (Power over Ethernet):** PoE wired Ethernet LANs allow the electrical current necessary for the operation to be carried by the data cable rather than carried by **power cords** thus removing the needs for an external power supply.
- Green – Mini SIM slot (2FF)
- Orange – GPS / Diversity SMA Antenna Connector: Female (GPS only on LTE version)
- Yellow - Cellular SMA Antenna Connector: Female

### 4.3 Front Panel Details

**Figure 5:** Front Panel



4.3.1 The top panel of Maestro's E220 Series features 6 LEDs on the front to indicate critical system information.

**Table 3:** LED States and Description

Name	Color and State	Description
Wi-Fi	OFF	Wi-Fi network is inactive
	Blue Flashing	Wi-Fi network connection traffic
	Blue ON	Wi-Fi network is up and activate
Activity	OFF	Cellular data service is not connected
	Amber ON	Cellular data service is connected
Network	OFF	Device is not registered on a cellular network
	Amber Flashing	Registered on roaming cellular network
	Amber ON	Registered on home cellular network
Signal	OFF	No signal (CSQ=0 to 5, 97, 98, 99)
	Amber ON	Strong signal (CSQ > 12)
	Amber Flashing	Weak signal (CSQ > 6 to 12)
Power	OFF	Power off
	Green ON	Power on
Alert 	OFF	No alert, device is running smoothly
	Red Flashing	Software fault (crash, issues)
	Red ON	Hardware fault (high temperature, problem with module or SIM card)

## 5.0 Connecting Maestro Router

5.1.1 Insert the SIM card in the router as shown below.

**Figure 6:** Inserting the SIM card in the Maestro router

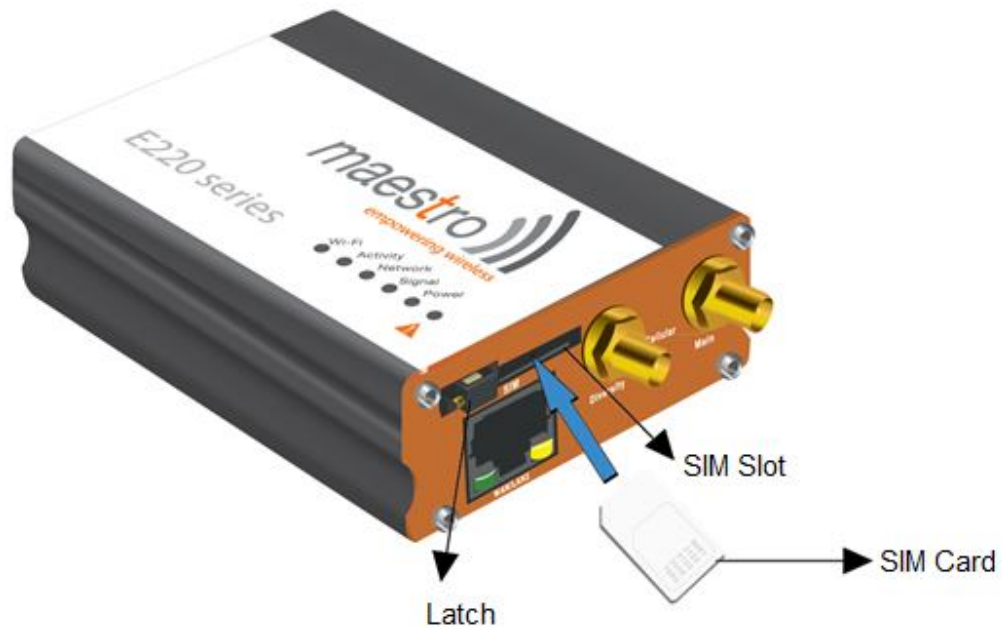

5.1.2 Connect the antenna to the main connector of the E220.

**IMPORTANT:** Verify the antenna is tightly secured.

5.1.3 Connect the Diversity antenna to the Diversity connector.

**Figure 7:** Connecting the Wi-Fi & cellular antenna on Maestro router:

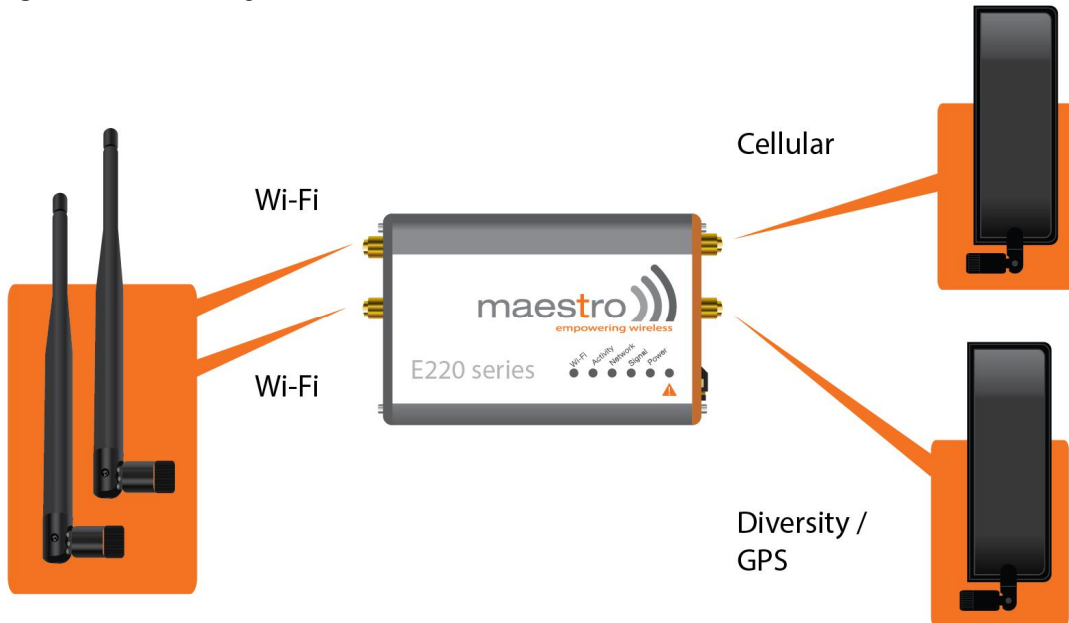

5.1.4 If the Maestro Router package includes dual antenna; connect the Diversity Antenna to the Diversity Connector.

**NOTE:** Dual antenna provides RF diversification, which allows for improved signal strength and thus better performance for both Wi-Fi and cellular,

Certain circumstances and environments may require the use of specific type of antenna or one mounted in a different location. In such case, Maestro has many antenna options to choose from, please contact Maestro Support at [support@maestro-wireless.com](mailto:support@maestro-wireless.com).

**Table 4:** E220 series models and auxiliary antennas:

Main	Model	Auxiliary	Comment
Cellular only	E225 Lite	N/A	
	E224 Lite	Cellular only	Please ensure that the antenna used is suitable for the cellular frequencies in use, for both main and auxiliary connectors
	E225	GPS only	
	E224 E228	2-mode GPS and cellular	Please ensure that the antenna used is suitable for the cellular frequencies in use, for both main and auxiliary connectors

5.1.5 Connect the router LAN port with the computer LAN port.

**Figure 8:** Connecting the router and computer LAN port

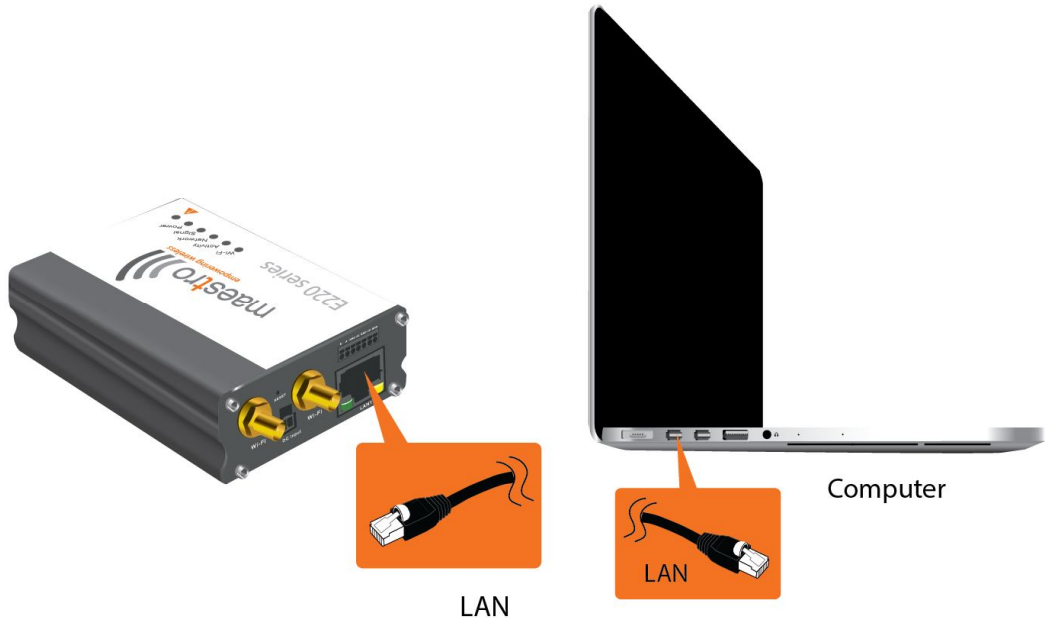

5.1.6 Connect the AC power to the DC in connector, then connect the Micro-Fit connector to the power input, located on the LAN-side panel of the Maestro Router.

- Plug the AC cord into a standard AC receptacle as shown below.
- The power LED will light when power is applied.

**Figure 9:** Connecting the AC power connector

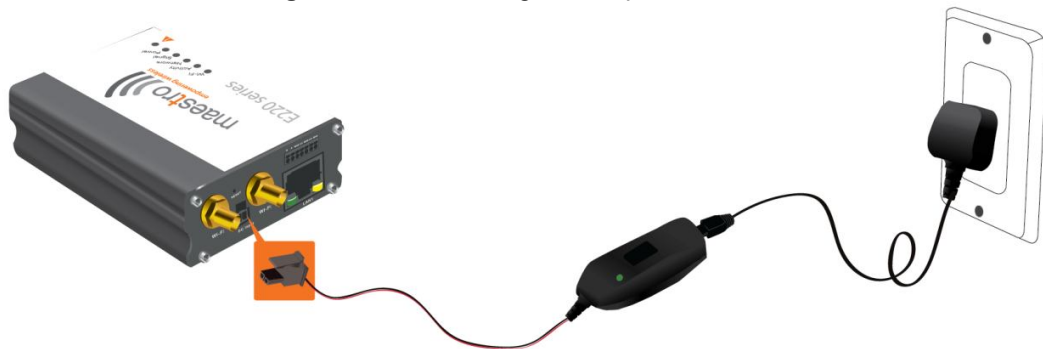

5.1.7 An alternate option is to power the Maestro Router over Ethernet port as the WAN port supports PoE (Power over Ethernet).

**NOTE:** Please refer to the section Power over Ethernet on Appendix 1 for connections example.

## 6.0 Software Configuration

6.1.1 On the computer, open a Web browser and then enter the Maestro routers LAN IP address. A login dialog window displays.

**NOTE:** Username and Password are case sensitive.

**Figure 10:** Login Dialog Box

**Table 5:** Web Admin Page

Parameters	Details
IP Address (LAN)	192.168.1.1
Username	admin
Password	admin

**Table 6:** Wi-Fi enabled, with WPA/WPA2 TKIP key

Parameter	Details
SSID	Maestro
WPA Key	W1rele\$\$

6.1.2 Click **Next** on the Quick Start Network Configuration Page ([figure 11](#)).

6.1.2.1 Configure the network parameters for **LAN, WAN, Cellular** and **Wi-Fi**.

6.1.2.2 Alternately, go to **Management Settings**, import and load predefined settings file.

6.1.2.3 Click **Save & Apply** to set the configuration.

**NOTE:** Default WAN, LAN and cellular connection settings:

6.1.2.4 WAN connection – Automatic (DHCP – Automatic IP address lookup).

6.1.2.5 Active DHCP with starting IP address: 192.168.1.100 with poll off 100 clients.

6.1.2.6 WAN as automatic IP, with Cellular backup.

6.1.2.7 Cellular default APN is "internet"

Figure 11: Quick Start Network Configuration Page

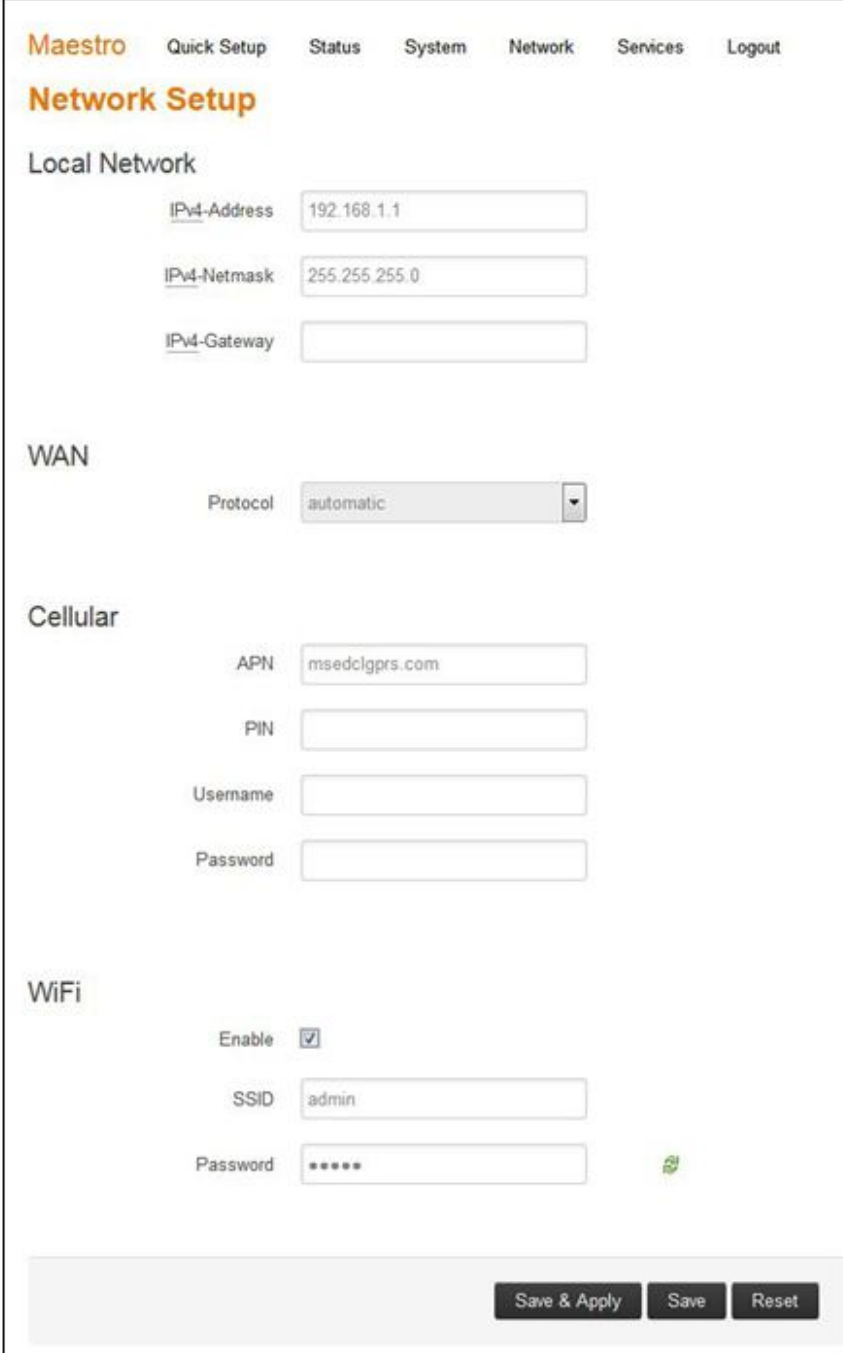

The screenshot shows the 'Network Setup' page in the Maestro web interface. At the top, there is a navigation menu with 'Maestro' in orange and 'Quick Setup', 'Status', 'System', 'Network', 'Services', and 'Logout' in grey. Below the navigation is the 'Network Setup' title in orange. The page is divided into three sections: 'Local Network', 'WAN', and 'WiFi'.  
- **Local Network:** Contains three input fields: 'IPv4-Address' with the value '192.168.1.1', 'IPv4-Netmask' with the value '255.255.255.0', and 'IPv4-Gateway' which is empty.  
- **WAN:** Contains a 'Protocol' dropdown menu set to 'automatic'.  
- **Cellular:** Contains four input fields: 'APN' with the value 'msedclgprs.com', 'PIN' (empty), 'Username' (empty), and 'Password' (empty).  
- **WiFi:** Contains an 'Enable' checkbox checked with a green checkmark, an 'SSID' input field with the value 'admin', and a 'Password' input field with five asterisks. A small green Wi-Fi icon is visible to the right of the password field.  
At the bottom right of the form, there are three buttons: 'Save & Apply', 'Save', and 'Reset'.

**Table 7:** Quick Start Network Configuration Page

Screen Element	Description
<b>Local Network</b>	
IPv4-Address	Enter the IPv4 Address of LAN interface. The default IPv4 Address is 192.168.1.1
IPv4-Netmask	Enter the IPv4 Subnet Mask of LAN interface. The default Netmask is 255.255.255.0
IPv4-Gateway	Enter the Gateway IPv4 of the Gateway.
<b>WAN</b>	
Protocol	Select the WAN protocol from the available options: <ul style="list-style-type: none"> <li>• Manual</li> <li>• Automatic</li> <li>• PPPoE</li> </ul> The default WAN protocol is selected as Automatic.
<b>Cellular</b>	
APN	Enter the APN provided by the cellular network operator. Access Point Name (APN) is the name (Web address) of an access point for LTE data connection. Generally, wireless cellular network operator provides the APN to their end users.
PIN	Enter the PIN of the SIM card. SIM card Personal Identification Number (PIN) is used to lock the card, preventing unauthorized phone calls or access to cellular data.
Username	Enter the login name.
Password	Enter the password.
<b>Wi-Fi</b>	
Enable	By default, Wi-Fi interface is enabled every time the Maestro Router reboots. Click and disable the Wi-Fi interface if you do not want to use them.
SSID	Service Set Identifier (SSID) is a sequence of characters, which uniquely names a wireless local area network (WLAN). The default SSID is <b>Maestro</b> .
Password	The default password is <b>W1rele\$\$</b> .



## 7.0 Conformity

### 7.1 Federal Communications Commission (FCC) Compliance Statement

7.1.1 This device complies with part 15 of the FCC Rules. Operation is subject to the following two conditions:

- This device may not cause harmful interference.
- This device must accept any interference received, including interference that may cause undesired operation.

7.1.2 This device has been tested and found to comply with the limits for a Class B digital pursuant to Part 15 of the FCC Rules. These limits are designed to provide reasonable protection against harmful interference in a residential installation. This equipment generates, uses and can radiate radio frequency energy.

7.1.2.1 If not installed and used in accordance with the instructions, may cause harmful interference to radio communications. here is no guarantee that interference will not occur in a particular installation.

7.1.2.2 If this equipment does cause harmful interference to radio or television reception, which can be determined by turning the equipment off and on, the user is encouraged to try to correct the interference by one or more of the following measures:

- Reorient or relocate the receiving antenna.
- Increase the separation between the equipment and receiver.
- Connect the equipment into an outlet on a circuit different from that to which the receiver is connected.
- Consult the dealer or an experienced radio/TV technician for help.

7.1.3 FCC Caution:

7.1.3.1 Changes or modifications not expressly approved by the party responsible for compliance could void the user's authority to operate the equipment.

### 7.2 FCC RF Exposure statement

This device complies with FCC radiation exposure limits set forth for an uncontrolled environment. In order to avoid the possibility of exceeding the FCC radio frequency exposure limits, human proximity to the antenna shall not be less than 20cm (8 inches) during normal operation.

### 7.3 ISED Notice

This device complies with Innovation, Science and Economic Development Canada license-exempt RSS standard(s). Operation is subject to the following two conditions:

- (1) this device may not cause interference, and
- (2) this device must accept any interference, including interference that may cause undesired operation of the device.

Le présent appareil est conforme aux CNR Innovation, Sciences et Développement économique Canada applicables aux appareils radio exempts de licence. L'exploitation est autorisée aux deux conditions suivantes :

- (1) l'appareil ne doit pas produire de brouillage, et
- (2) l'utilisateur de l'appareil doit accepter tout brouillage radioélectrique subi, même si le brouillage est susceptible d'en

This Class B digital apparatus complies with Canadian ICES-003.

Cet appareil numérique de la classe B est conforme à la norme NMB-003 du Canada.

IC: 20055-E228F7, 20055-E224LITEF2, 20055-E224LITEF4, 20055-E225LITEF3, 20055-E225F3, 20055-E228F2, 20055-E228F5

#### 7.4 ISED RF Exposure Information

This device complies with ISED radiation exposure limits set forth for an uncontrolled environment. In order to avoid the possibility of exceeding the ISED radio frequency exposure limits, human proximity to the antenna shall not be less than 20cm (8 inches) during normal operation.

Cet appareil est conforme aux limites d'exposition aux rayonnements de la ISED CNR-102 définies pour un environnement non contrôlé. Afin d'éviter la possibilité de dépasser les limites d'exposition aux fréquences radio de la ISED CNR-102, la proximité humaine à l'antenne ne doit pas être inférieure à 20 cm (8 pouces) pendant le fonctionnement normal.

8.0 Appendix:

8.1 Pin Power Cable Schematic

Figure 12:

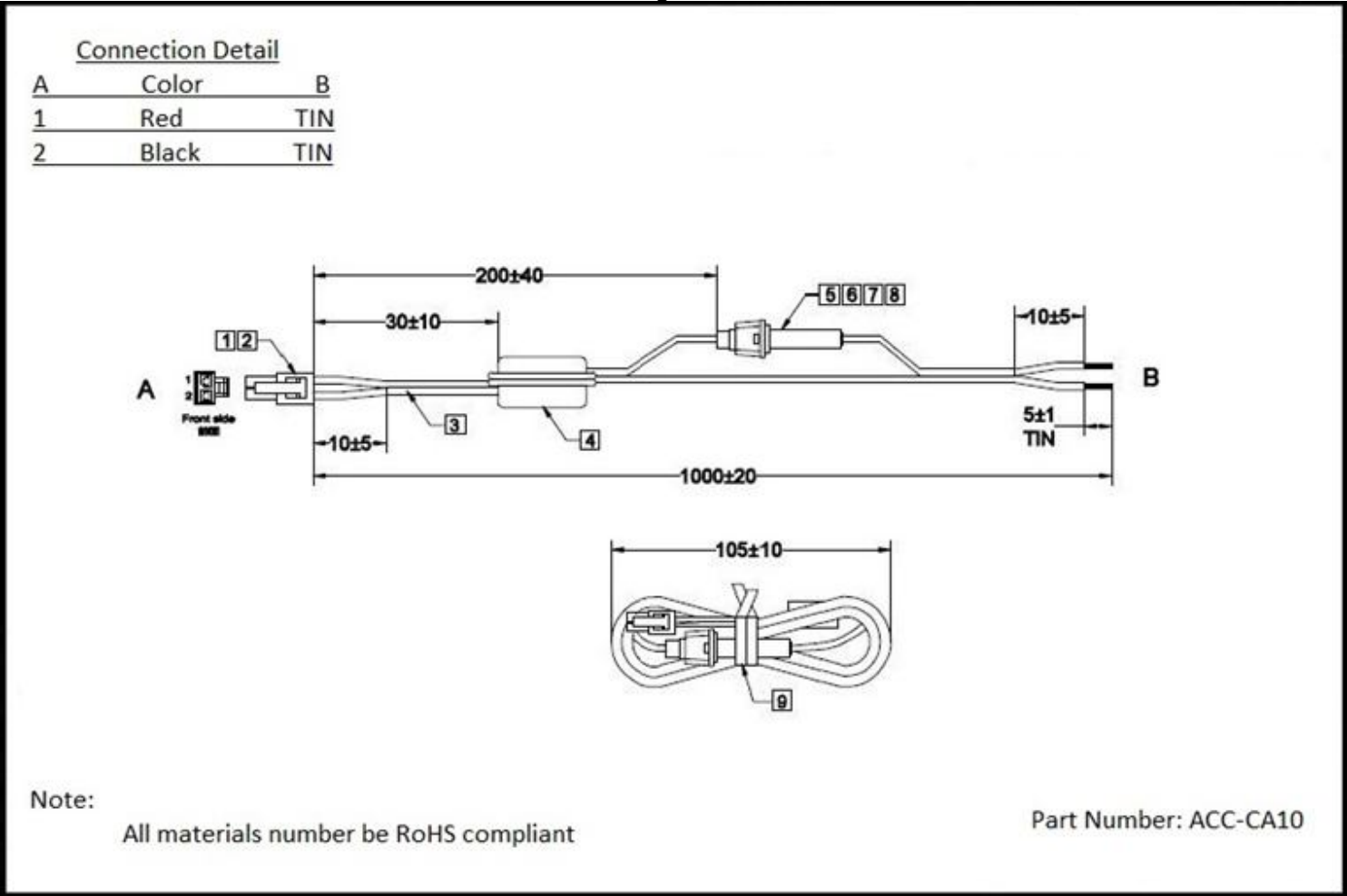

---

## 8.2 Power over Ethernet

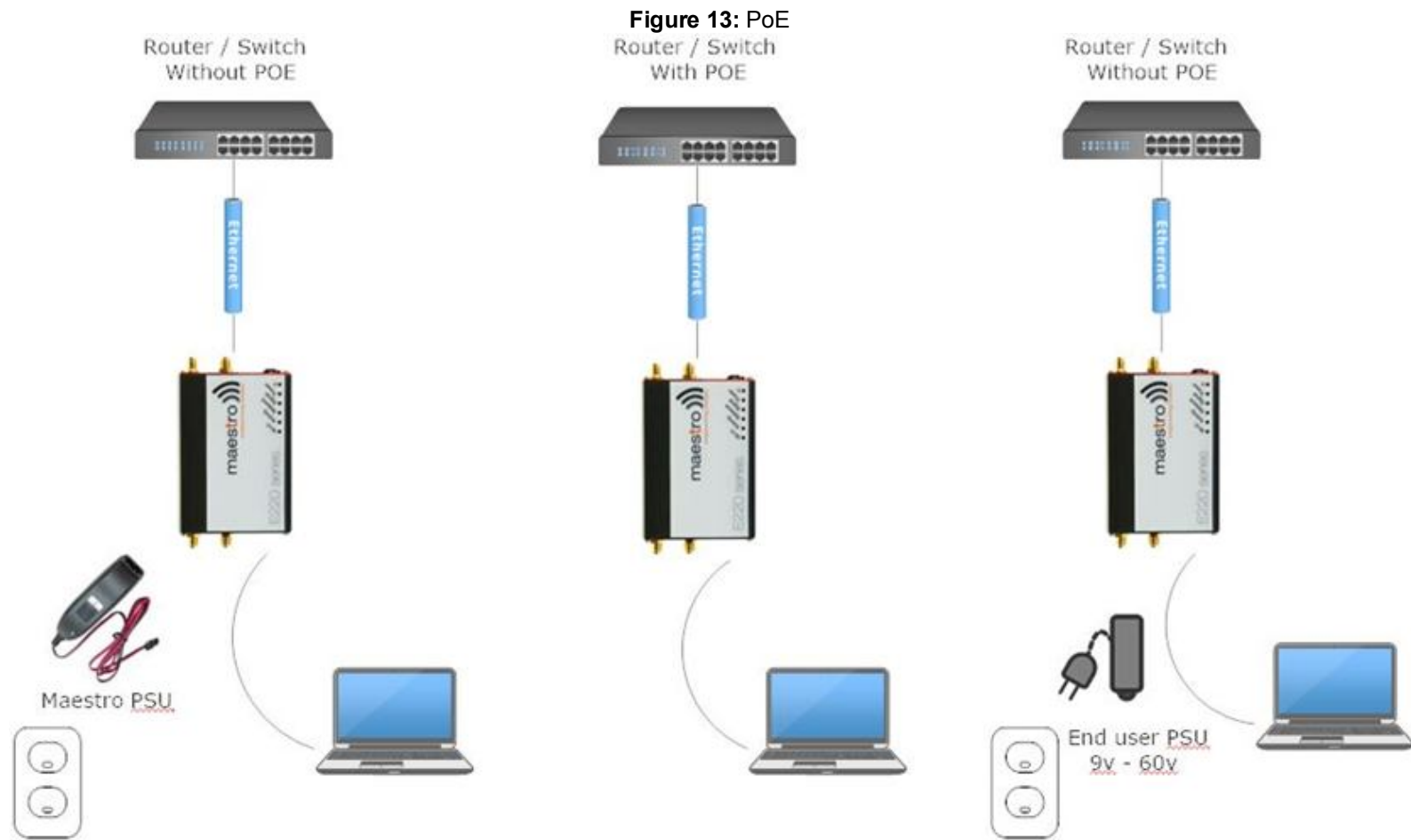

---

### 8.3 RS485 wiring diagram

**Figure 14:** Half Duplex (Left) RS485 Full Duplex (Right)

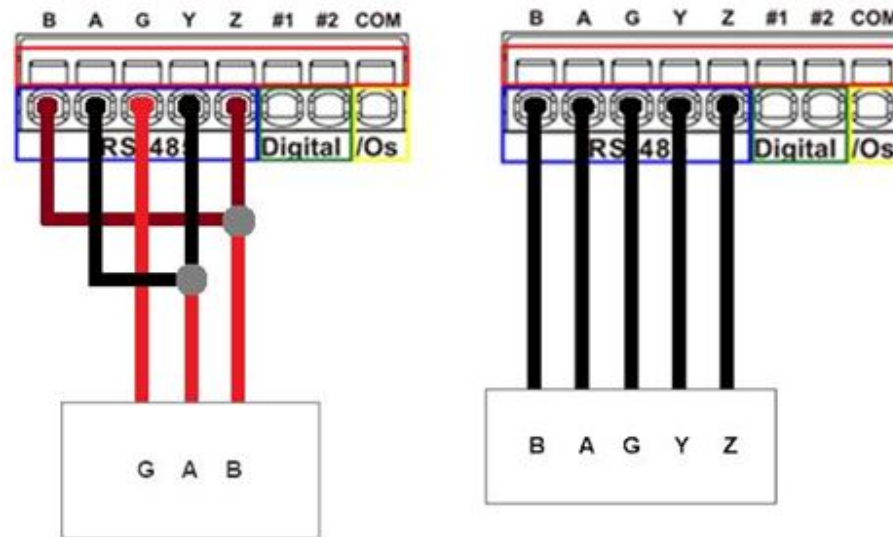

---

## 8.4 Certified antenna

Dipole Wi-Fi antenna:

- 5 dBi high performance antenna
- RP-SMA(M) hinged antenna
- RoHS compliant
- Peak gain: 3.8 dBi @2.4 GHz ~ 2.5 GHz

WWAN antenna:

- Dipole 4G swivel blade antenna
- Performance across the LTE frequency bands
- 698-960 / 1710-2170 / 2500-2700 MHz
- Up to 2 dBi gain
- SMA connector
- RoHS compliant product

## 8.5 Selection of antenna

Selection of Wi-Fi antenna:

- Dipole, Peak Gain < 3.8 dBi @ 2.4 GHz ~ 2.5 GHz

Selection of antenna type:

- Using the same dipole antenna type as certified module & Modem for FCC as above or external antenna with length > 20 cm.
-