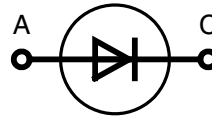
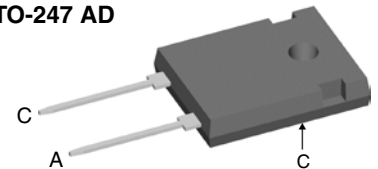

# Fast Recovery Epitaxial Diode (FRED)

$I_{FAVM} = 126 \text{ A}$   
 $V_{RRM} = 600 \text{ V}$   
 $t_{rr} = 35 \text{ ns}$

$V_{RSM}$	$V_{RRM}$	Type
V	V	
600	600	DSEI 120-06A

**TO-247 AD**

A = Anode, C = Cathode

Symbol	Conditions	Maximum Ratings	
$I_{FRMS}$	$T_{VJ} = T_{VJM}$	100	A
$I_{FAVM}$ ①	$T_C = 70^\circ\text{C}$ ; rectangular, $d = 0.5$	126	A
$I_{FAV}$ ②	$T_C = 110^\circ\text{C}$ ; rectangular, $d = 0.5$	77	A
$I_{FRM}$	$t_p < 10 \mu\text{s}$ ; rep. rating, pulse width limited by $T_{VJM}$	1200	A
$I_{FSM}$	$T_{VJ} = 45^\circ\text{C}$ ; $t = 10 \text{ ms}$ (50 Hz), sine $t = 8.3 \text{ ms}$ (60 Hz), sine	600	A
		660	A
	$T_{VJ} = 150^\circ\text{C}$ ; $t = 10 \text{ ms}$ (50 Hz), sine $t = 8.3 \text{ ms}$ (60 Hz), sine	540	A
		600	A
$I^2t$	$T_{VJ} = 45^\circ\text{C}$ ; $t = 10 \text{ ms}$ (50 Hz), sine $t = 8.3 \text{ ms}$ (60 Hz), sine	1800	A <sup>2</sup> s
		1800	A <sup>2</sup> s
	$T_{VJ} = 150^\circ\text{C}$ ; $t = 10 \text{ ms}$ (50 Hz), sine $t = 8.3 \text{ ms}$ (60 Hz), sine	1450	A <sup>2</sup> s
		1500	A <sup>2</sup> s
$T_{VJ}$		-40...+150	°C
$T_{VJM}$		150	°C
$T_{stg}$		-40...+150	°C
$P_{tot}$	$T_C = 25^\circ\text{C}$	357	W
$M_d$	mounting torque	0.8...1.2	Nm
<b>Weight</b>	typical	6	g

## Features

- International standard package JEDEC TO-247 AD
- Planar passivated chips
- Very short recovery time
- Extremely low switching losses
- Low  $I_{RM}$ -values
- Soft recovery behaviour
- Epoxy meets UL 94V-0

## Applications

- Antiparallel diode for high frequency switching devices
- Anti saturation diode
- Snubber diode
- Free wheeling diode in converters and motor control circuits
- Rectifiers in switch mode power supplies (SMPS)
- Inductive heating and melting
- Uninterruptible power supplies (UPS)
- Ultrasonic cleaners and welders

## Advantages

- High reliability circuit operation
- Low voltage peaks for reduced protection circuits
- Low noise switching
- Low losses
- Operating at lower temperature or space saving by reduced cooling

Symbol	Conditions	Characteristic Values		
		typ.	max.	
$I_R$	$V_R = V_{RRM}$	$T_{VJ} = 25^\circ\text{C}$		3 mA
	$V_R = 0.8 \cdot V_{RRM}$	$T_{VJ} = 25^\circ\text{C}$		0.75 mA
	$V_R = 0.8 \cdot V_{RRM}$	$T_{VJ} = 125^\circ\text{C}$		20 mA
$V_F$	$I_F = 70 \text{ A}$	$T_{VJ} = 150^\circ\text{C}$		1.12 V
		$T_{VJ} = 25^\circ\text{C}$		1.3 V
$V_{T0}$	for power-loss calculations only			0.85 V
$r_T$	$T_{VJ} = T_{VJM}$			3.5 mΩ
$R_{thJC}$	(version A)		0.25	0.35 K/W
$R_{thCH}$				K/W
$R_{thJA}$			35	K/W
$t_{rr}$	$I_F = 1 \text{ A}$ ; $-di/dt = 200 \text{ A}/\mu\text{s}$ ; $V_R = 30 \text{ V}$ ; $T_{VJ} = 25^\circ\text{C}$	35	50	ns
$I_{RM}$	$V_R = 350 \text{ V}$ ; $I_F = 80 \text{ A}$ ; $-di_F/dt = 200 \text{ A}/\mu\text{s}$ $L \leq 0.05 \mu\text{H}$ ; $T_{VJ} = 100^\circ\text{C}$	17	21	A

① Chip capability, ② limited to 70 A by leads Data according to IEC 60747

IXYS reserves the right to change limits, test conditions and dimensions.

20121114a

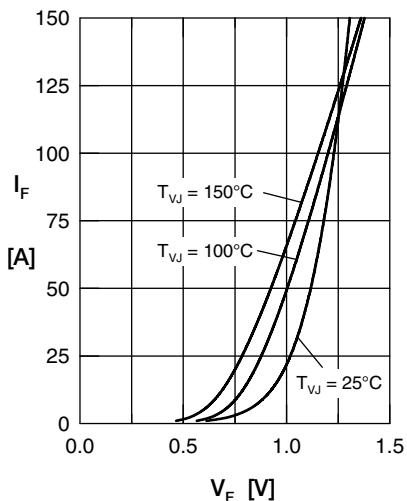

Fig. 1 Forward current  $I_F$  vs.  $V_F$

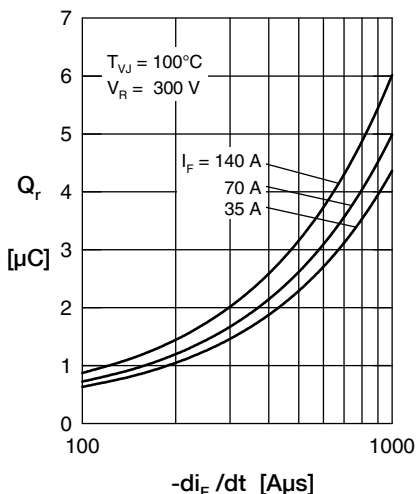

Fig. 2 Reverse recovery charge  $Q_r$  versus  $-di_F/dt$

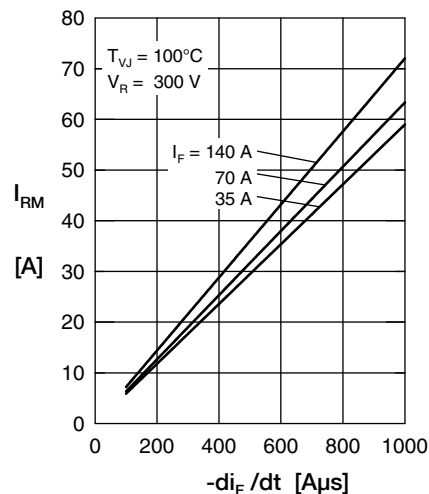

Fig. 3 Peak reverse current  $I_{RM}$  versus  $-di_F/dt$

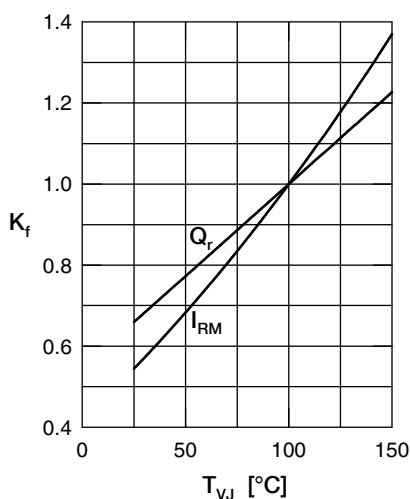

Fig. 4 Dynamic parameters  $Q_r$ ,  $I_{RM}$  versus  $T_{VJ}$

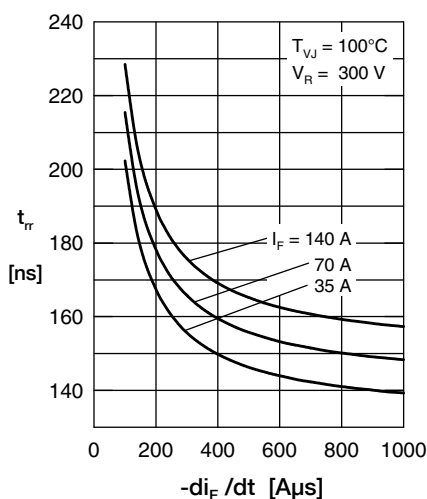

Fig. 5 Recovery time  $t_{tr}$  versus  $-di_F/dt$

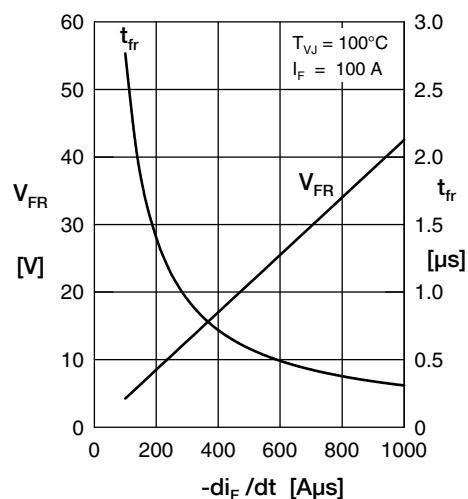

Fig. 6 Peak forward voltage  $V_{FR}$  and  $t_{fr}$  versus  $-di_F/dt$

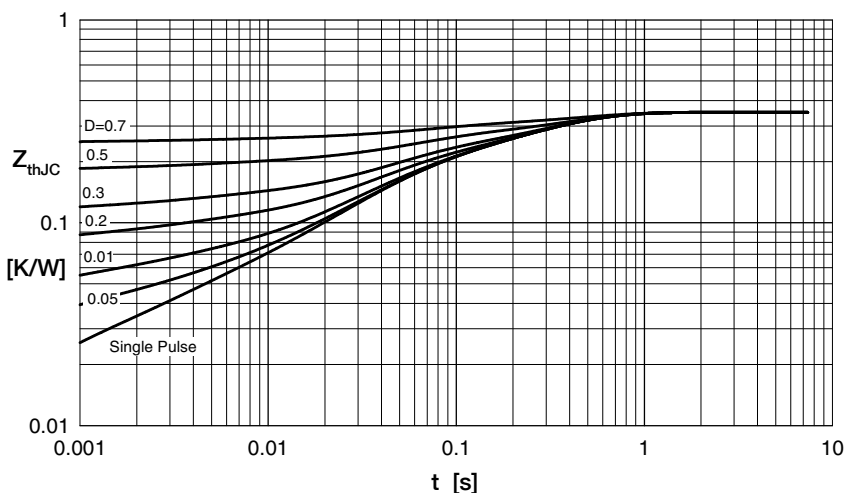
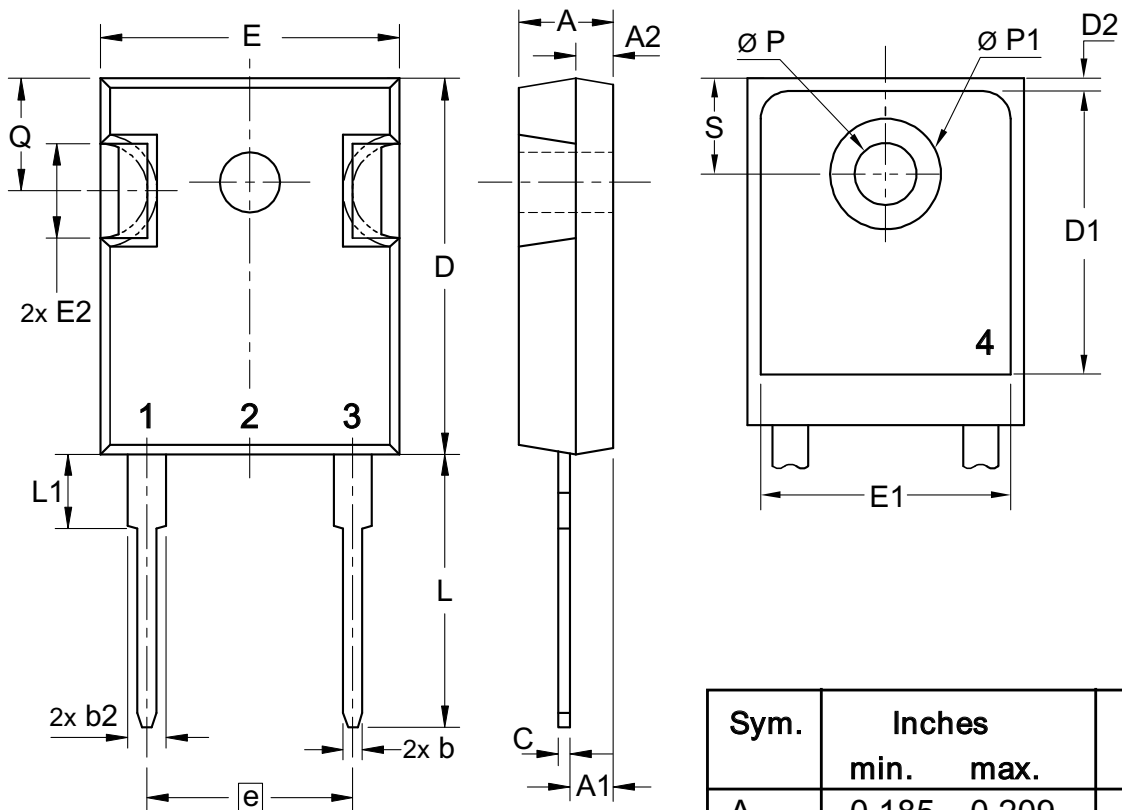

Fig. 7 Transient thermal resistance junction to case at various duty cycles

Constants for  $Z_{thJC}$  calculation:

i	$R_{thi}$ (K/W)	$t_i$ (s)
1	0.017	0.00038
2	0.0184	0.0026
3	0.1296	0.0387
4	0.185	0.274

## Dimensions TO-247 AD



Sym.	Inches		Millimeter	
	min.	max.	min.	max.
A	0.185	0.209	4.70	5.30
A1	0.087	0.102	2.21	2.59
A2	0.059	0.098	1.50	2.49
D	0.819	0.845	20.79	21.45
E	0.610	0.640	15.48	16.24
E2	0.170	0.216	4.31	5.48
e	0.430 BSC		10.92 BSC	
L	0.780	0.800	19.80	20.30
L1	-	0.177	-	4.49
Ø P	0.140	0.144	3.55	3.65
Q	0.212	0.244	5.38	6.19
S	0.242 BSC		6.14 BSC	
b	0.039	0.055	0.99	1.40
b2	0.065	0.094	1.65	2.39
b4	0.102	0.135	2.59	3.43
c	0.015	0.035	0.38	0.89
D1	0.515	-	13.07	-
D2	0.020	0.053	0.51	1.35
E1	0.530	-	13.45	-
Ø P1	-	0.29	-	7.39