

#### Industries & Applications



Automation



Industrial



Semi-Fab



Renewable



Comms



Test



#### Features & Benefits

- ▶ **Wide 3 phase input range** for various AC power systems
- ▶ **Parallel mode switch** to activate load balancing behaviour
- ▶ **Two means of transient protection** increase process stability
- ▶ **Fast OVP control** protects sensitive loads
- ▶ **Very low inrush energy peak (I<sup>2</sup>t)** saves cost for input line protection
- ▶ **Screw or push-in terminals available** to serve individual application needs
- ▶ **High efficiency and low stand-by losses contribute to an eco-friendly energy footprint**
- ▶ **DC-OK and inhibit relay contacts** for professional integration into applications control architecture
- ▶ **Comprehensive boost power capabilities** support start-up into capacitive loads and increase system design flexibility
- ▶ Designed to meet the 7 most accepted IEC safety standards
- ▶ Exceeds regulatory EMC standards on radiated emission (Class B), surge immunity and fast transients

#### Technical data abstract<sup>1</sup>

Output voltage	nom.	72V <sub>DC</sub>
Adjustment range	nom.	70 .. 85V <sub>DC</sub>
Output current	nom.	13.3A
Boost current 1 <sup>4</sup>	max.	20A / 5s
Boost current 2 <sup>4</sup>	max.	20A / 7s
Overload behaviour		CC + Intermittent mode (Hiccup)
Hold-up time	min.	20ms
Frequency range	max.	47 .. 63Hz
AC input voltage	nom.	3x400 .. 500V <sub>AC</sub>
AC input voltage range	max.	3x350 .. 575V <sub>AC</sub>
Inrush current <sup>2</sup>	typ.	17 / 20A <200µs
Inrush energy <sup>2</sup>	typ.	0.02 / 0.02A <sup>2</sup> s
Output power	nom.	960W
Boost power 1 <sup>4</sup>	max.	1440W / 5s
Boost power 2 <sup>4</sup>	max.	1440W / 7s
Power factor	typ.	0.94
Conversion efficiency <sup>2</sup>	typ.	96.3 / 96.2%
Power losses <sup>2</sup>	typ.	36.9 / 37.9W
No-load consumption	max.	5.6W
Ambient operating temperature	max. nom.	-25 .. +70°C (-13 .. +158°F) -25 .. +55°C (-13 .. +131°F)
Service lifetime <sup>2</sup>	min.	130 000 / 124 000hrs
Service life MTBF <sup>3</sup>	min.	3.80M / 0.67M hrs
Width		100mm (3 <sup>15</sup> / <sub>16</sub> in)
Height		129mm (5 <sup>5</sup> / <sub>64</sub> in)
Depth		171.9mm (6 <sup>49</sup> / <sub>64</sub> in)
Weight		1750g (3.86lb)

<sup>1</sup>All values refer to STC unless otherwise stated | <sup>2</sup>400 / 500V<sub>AC</sub> | <sup>3</sup>50% / 100% P<sub>out,nom</sub> |

<sup>4</sup> See duty cycle 1/2 under „4. Performance“ on page 8

#### Certifications & Approvals



IEC EN 61010-1  
IEC EN 61010-2-201  
IEC EN 62368-1 (Ed.2)



UL CSA 61010-1  
UL CSA 61010-2-201  
E356563



UL CSA 62368-1 (Ed.2)  
E511889

#### Compliance & Registration



EU Low Voltage Dir. 2014/35/EU  
EU EMC Dir. 2014/30/EU  
EU RoHS Dir. 2011/65/EU



Safety and EMC Reg. 2016  
Hazard. Substances Reg. 2012



Registration for Russia, Belarus, Armenia,  
Kazakhstan and Kyrgyzstan



China RoHS Law SJ/T 11363-2006



## Commercial information

<b>Order codes</b>	DRB960-72-3-A0 DRB960-72-3-A1
<b>HS code</b>	8504408290
<b>Life-cycle status</b>	Launch
<b>Product revision</b>	E01
<b>Single package</b>	
Width	107mm (4 <sup>1</sup> / <sub>32</sub> in)
Height	224mm (8 <sup>13</sup> / <sub>16</sub> in)
Depth	182mm (7 <sup>11</sup> / <sub>64</sub> in)
Gross weight	1930g (4.25lb)
<b>Bulk package</b>	
Width	343mm (13 <sup>1</sup> / <sub>2</sub> in)
Height	210mm (8 <sup>17</sup> / <sub>64</sub> in)
Depth	465mm (18 <sup>5</sup> / <sub>16</sub> in)
Quantity	6 units
<b>Pallet</b>	
Width	1000mm (39 <sup>3</sup> / <sub>8</sub> in)
Length	1200mm (47 <sup>1</sup> / <sub>4</sub> in)
Quantity	144 units
<b>Manufacturer warranty</b>	3 years

## Model selector

Model name	Output Power	Output Voltage	Feature
DRB120-12-3-A0	120W	12V <sub>DC</sub>	Screw terminals
DRB120-12-3-A1	120W	12V <sub>DC</sub>	Push-in terminals
DRB120-24-3-A0	120W	24V <sub>DC</sub>	Screw terminals
DRB120-24-3-A1	120W	24V <sub>DC</sub>	Push-in terminals
DRB240-24-3-A0	240W	24V <sub>DC</sub>	Screw terminals
DRB240-24-3-A1	240W	24V <sub>DC</sub>	Push-in terminals
DRB240-48-3-A0	240W	48V <sub>DC</sub>	Screw terminals
DRB240-48-3-A1	240W	48V <sub>DC</sub>	Push-in terminals
DRB480-24-3-A0	480W	24V <sub>DC</sub>	Screw terminals
DRB480-24-3-A1	480W	24V <sub>DC</sub>	Push-in terminals
DRB480-48-3-A0	480W	48V <sub>DC</sub>	Screw terminals
DRB480-48-3-A1	480W	48V <sub>DC</sub>	Push-in terminals
DRB480-72-3-A0	480W	72V <sub>DC</sub>	Screw terminals
DRB480-72-3-A1	480W	72V <sub>DC</sub>	Push-in terminals
DRB960-24-3-A0	960W	24V <sub>DC</sub>	Screw terminals
DRB960-24-3-A1	960W	24V <sub>DC</sub>	Push-in terminals
DRB960-48-3-A0	960W	48V <sub>DC</sub>	Screw terminals
DRB960-48-3-A1	960W	48V <sub>DC</sub>	Push-in terminals
DRB960-72-3-A0	960W	72V <sub>DC</sub>	Screw terminals
DRB960-72-3-A1	960W	72V <sub>DC</sub>	Push-in terminals



## Index

<b>1.</b>	<b>General</b> .....	<b>5</b>
1.1	Proper handling of the product.....	5
1.2	Protection enclosure required.....	5
1.3	Humid environments.....	5
1.4	Switch or circuit-breaker mounting position.....	5
1.5	Observe country-specific regulations.....	5
1.6	Prohibited electrical/mechanical modifications.....	5
1.7	Expiry of the manufacturer's warranty.....	5
1.8	Use of third-party products.....	5
1.9	Standard test conditions.....	5
1.10	Description of user elements.....	5
<b>2.</b>	<b>Electrical output</b> .....	<b>6</b>
<b>3.</b>	<b>Electrical input</b> .....	<b>7</b>
<b>4.</b>	<b>Performance</b> .....	<b>8</b>
<b>5.</b>	<b>Ambient conditions</b> .....	<b>9</b>
<b>6.</b>	<b>Reliability and Service lifetime</b> .....	<b>11</b>
<b>7.</b>	<b>Dimensions &amp; Mechanical data</b> .....	<b>11</b>
<b>8.</b>	<b>Installation clearances</b> .....	<b>13</b>
<b>9.</b>	<b>Wiring &amp; Connection</b> .....	<b>13</b>
<b>10.</b>	<b>Signaling &amp; Control</b> .....	<b>14</b>
<b>11.</b>	<b>Block diagram</b> .....	<b>15</b>
<b>12.</b>	<b>Device protection</b> .....	<b>15</b>
<b>13.</b>	<b>Electrical Safety</b> .....	<b>16</b>
13.1	Overvoltage category design.....	16
13.2	Insulation strength.....	16
13.3	HIPOT test.....	17
<b>14.</b>	<b>Electromagnetic immunity</b> .....	<b>18</b>
<b>15.</b>	<b>Electromagnetic emission</b> .....	<b>18</b>
<b>16.</b>	<b>Certifications &amp; Approvals</b> .....	<b>19</b>
<b>17.</b>	<b>Designed to meet</b> .....	<b>19</b>
<b>18.</b>	<b>Compliance &amp; Registration</b> .....	<b>19</b>
<b>19.</b>	<b>Typical use-cases</b> .....	<b>20</b>
19.1	Parallel Operation.....	20
19.2	Series operation.....	21
19.3	Two-phase operation.....	22



## List of abbreviations

<b>avg.</b>	<i>average</i>	The arithmetic average calculated from a row of values.
<b>CC</b>		Constant output current
<b>CGD</b>		Corner grounded delta (AC power system)
<b>chap.</b>		Chapter
<b>Dir.</b>		Directive
<b>eCap</b>		Electrolytic capacitor
<b>EMC</b>		Electromagnetic Compatibility
<b>Iac</b>		AC input current under a particular operating condition
<b>Iout</b>		DC output current under a particular operating condition
<b>Iout_boost</b>		Available current reserve beyond Iout_nom (w/o a drop in Uset) that can be delivered for a limited time.
<b>Iout_nom</b>		Continuous nominal DC output current under STC.
<b>Iout_ol</b>		Max. intermittent DC output current in an overload situation and a shortfall of Uset.
<b>Iout_sc</b>		Max. short circuit DC output current and Uout < 20% Uout_nom
<b>ITU</b>		International Telecommunication Union
<b>max.</b>	<i>maximum</i>	The maximum value which a parameter can assume, or which must not be exceeded.
<b>MCB</b>		Miniature circuit breaker
<b>min.</b>	<i>minimum</i>	The minimum value which a parameter can assume, or must not be fallen below.
<b>MTBF</b>		Mean Time Between Failure
<b>nom.</b>	<i>nominal</i>	The ideal or reference value of a technical parameter which is guaranteed under STC. All nominal values in this document refer to each other and represent the general specification of the device.
<b>OCP</b>		Overcurrent protection
<b>OTP</b>		Overtemperature protection
<b>OVP</b>		Overvoltage protection
<b>PELV</b>		Protective Extra Low Voltage
<b>Pout_boost</b>		Available power reserve beyond Pout_nom that can be delivered for a limited time.
<b>Pout_nom</b>		Nominal output power
<b>PSU</b>		Power supply unit
<b>Reg.</b>		Regulation
<b>SELV</b>		Safety Extra Low Voltage
<b>STC</b>		Standard test conditions (see „1. General“ on page 5)
<b>typ.</b>	<i>typical</i>	The typical value of a parameter is not guaranteed but can be assumed under STC. The min. or max. value must be determined during the engineering process of the end application.
<b>Uout</b>		DC output voltage under a particular operating condition
<b>Uout_nom</b>		Nominal DC output voltage
<b>Uset</b>		Manually set output voltage via voltage potentiometer
<b>UVP</b>		Undervoltage protection
<b>/</b>		Separator between two values. The conditions to which the values refer can be found in the last column of the table.
<b>..</b>		Specifies a range of values.

## Table data structure

### X. Technical category

Technical parameter	Characteristic (optional)	Values	Condition (optional)
---------------------	---------------------------	--------	----------------------

## 1. General

### 1.1 Proper handling of the product

The faultless and safe operation of the products requires proper transport, proper storage, set-up, assembly, installation, commissioning, operation and maintenance. The permissible ambient conditions must be observed. Instructions in the associated documentation must be observed.

### 1.2 Protection enclosure required

The device must be installed in a protective housing or control cabinet to which only qualified personnel have access.

### 1.3 Humid environments

Do not operate the device in a damp environment or in an environment where condensation is likely to occur.

### 1.4 Switch or circuit-breaker mounting position

A switch or circuit-breaker must be mounted near the equipment.

### 1.5 Observe country-specific regulations

In addition to the product documentation, the relevant country-specific regulations for the installation of the device must be observed.

### 1.6 Prohibited electrical/mechanical modifications

The product must not be modified in any way electrically or mechanically. Modifications can result in fatal injuries and damage to property.

### 1.7 Expiry of the manufacturer's warranty

The power supply is maintenance-free. Repairs can only be carried out by the manufacturer. Opening the housing voids the manufacturer's warranty.

### 1.8 Use of third-party products

If third-party products and components are used for power or voltage increase, buffering (AC or DC side), EMC filtering, redundancies or for DC side load protection, it must be in accordance with the TDK-Lambda product specification.

### 1.9 Standard test conditions

Unless otherwise stated, all values are specified in normal mounting position, at full load, nominal input and output voltages, 25°C (131°F) ambient temperature and a run-in time of 5 minutes.

### 1.10 Description of user elements

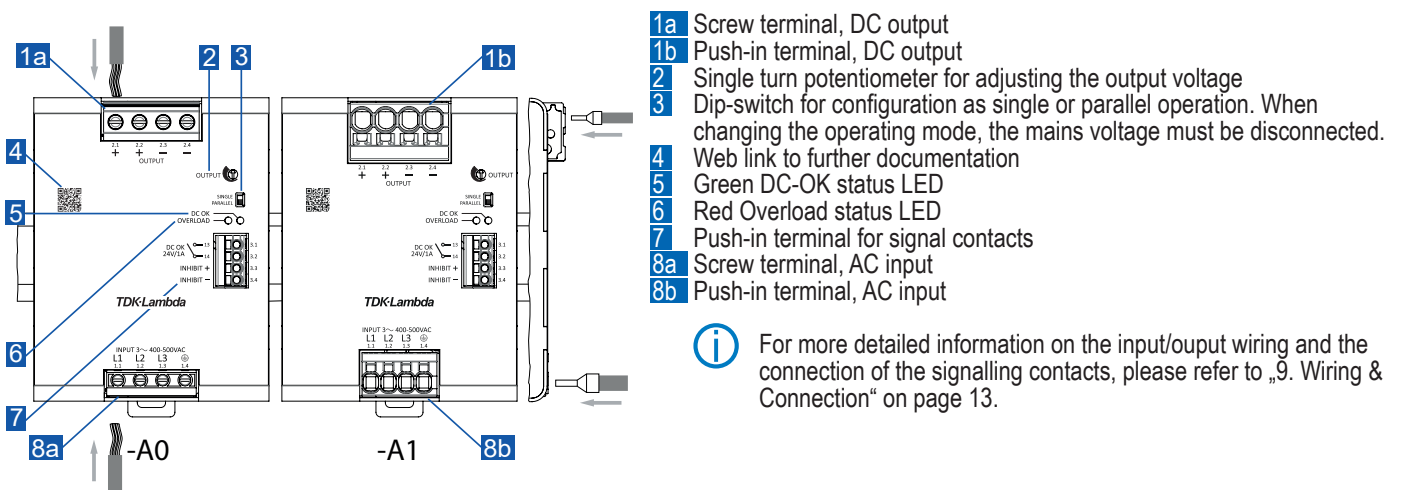

Fig. 1: Description of user elements

## 2. Electrical output

<b>Output voltage</b> [U <sub>out_nom</sub> ]	nom.	72V <sub>DC</sub>	
<b>Adjustment range</b> [U <sub>set</sub> ]	nom.	70..85V <sub>DC</sub>	
<b>Adjustment tolerance</b>	max.	±3%	at upper/lower end position of voltage potentiometer
<b>Factory default</b>		72V <sub>DC</sub> (±0.1%)	
<b>Output current</b> [I <sub>out_nom</sub> ]	nom.	13.3A	
<b>Boost current 1</b> [I <sub>out_boost1</sub> ]	max.	20A / 5s	<55°C <sub>amb</sub> , 100% I <sub>out_nom</sub> , 280..575V <sub>AC</sub>
<b>Boost current 2</b> [I <sub>out_boost2</sub> ]	max.	20A / 7s	<55°C <sub>amb</sub> , 100% I <sub>out_nom</sub> , 280..575V <sub>AC</sub>
<b>Overload behaviour</b>		Constant current + Intermittent mode (Hiccup)	see Fig. 3
<b>SC hiccup current</b> [I <sub>out_hc</sub> ]	max. avg.	20A / 5s 0A / 9.5s	
<b>Short-circuit proof</b>		yes, with auto-recovery	
<b>Instant SC current</b> [I <sub>out_sc</sub> ]	max.	50A <10ms	
<b>Start-up delay</b>	typ.	0.5s	
<b>Rise time</b>	typ.	285ms 305ms	0% P <sub>out_nom</sub> 100% P <sub>out_nom</sub> , resistive load
<b>Voltage overshoot</b>	typ.	0V <sub>DC</sub>	
<b>Fall time</b>	typ.	25ms	
<b>Hold-up time</b>	min.	20ms	
<b>Output capacitance</b>	max.	16 240μF	
<b>Capacitive load start-up</b>	max.	13 300μF	22.5..29V <sub>DC</sub>
<b>Feedback voltage</b>	max.	100V <sub>DC</sub>	
<b>Return voltage</b>	max.	29mA	OFF mode
<b>Line regulation</b>	max.	0.01%	350..550V <sub>AC</sub>
<b>Load regulation</b>	max.	-0.1% -2.5%	350..550V <sub>AC</sub> 350..550V <sub>AC</sub> , parallel mode
<b>Dynamic response</b>	typ.	±420mVpp	350..550V <sub>AC</sub> , 10..100% P <sub>out_nom</sub> , transient frequency 10Hz
<b>Ripple &amp; noise voltage</b>	max.	25mVpp 40mVpp	350..550V <sub>AC</sub> , +25..+70°C <sub>amb</sub> 350..550V <sub>AC</sub> , -25..+25°C <sub>amb</sub>

\*The measurement was performed with a short twisted pair cable using a 120μF eCap and a 0.1μF cCap connected in parallel. A bandwidth limit of 20MHz is required.

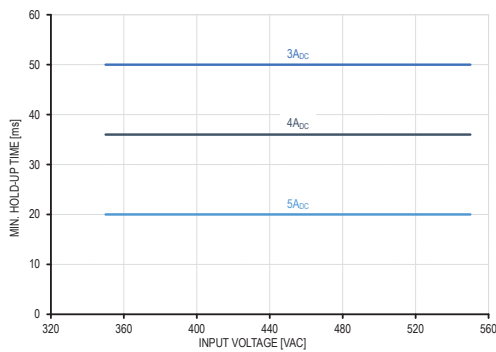

Fig. 2: Hold-up times under different load conditions and in dependence of the input voltage

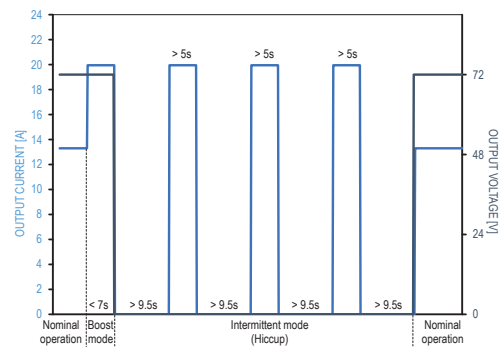

Fig. 3: Output current and voltage in different operation modes

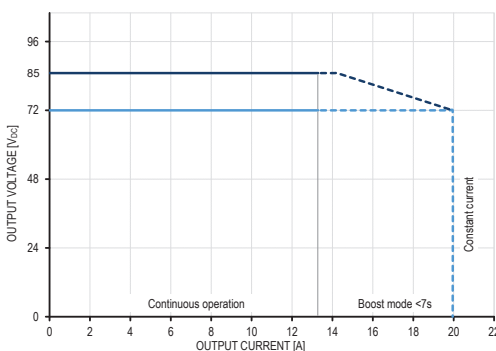

Fig. 4: Output voltage in dependence of output load current

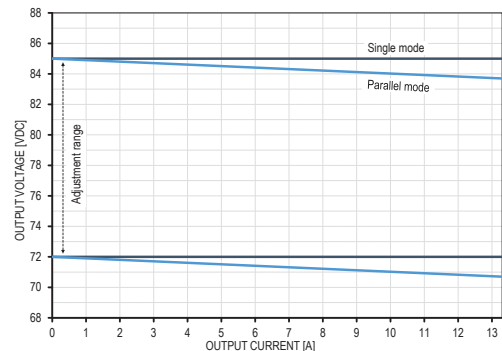

Fig. 5: Voltage drop in parallel mode in dependence of the load current

Unless otherwise stated, all values are specified in normal mounting position, at full load, nominal input and output voltages, 25°C (77°F) ambient temperature and a run-in time of 5 minutes.

### 3. Electrical input

<b>AC power systems</b>	TN, TT, IT (IEC 61010-1), CGD		
<b>Mains Frequency</b>	<i>nom.</i>	50 / 60Hz	
<b>Frequency range</b>	<i>max.</i>	47 .. 63Hz	
<b>AC input voltage*</b> [U <sub>in_nom</sub> ]	<i>nom.</i>	3x400 .. 500V <sub>AC</sub>	3AC, PE
<b>Voltage range</b>	<i>max.</i>	3x350 .. 575V <sub>AC</sub>	
<b>Turn-ON voltage</b>	<i>typ.</i>	315V <sub>AC</sub>	
<b>Turn-OFF voltage</b>	<i>typ.</i>	305V <sub>AC</sub>	
<b>AC input current</b>	<i>max.</i>	3x2.0A	Accordinging safety approval reports
<b>AC input current RMS</b>	<i>typ.</i>	3x1.6 / 3x1.3A	400 / 500V <sub>AC</sub>
<b>Crest factor</b>	<i>typ.</i>	1.7 / 1.8	400 / 500V <sub>AC</sub>
<b>Inrush current</b>	<i>typ.</i>	17 / 20A <200μs	400 / 500V <sub>AC</sub> , 25°C <sub>amb</sub> , cold start
<b>Inrush energy</b>	<i>typ.</i>	0.02 / 0.02A <sup>2</sup> s	400 / 500V <sub>AC</sub> , 25°C <sub>amb</sub> , cold start
<b>Input capacitance</b>	<i>max.</i>	60μF	

\*The product is also capable to operate with DC input voltage. Please contact your local support team (see page 23).

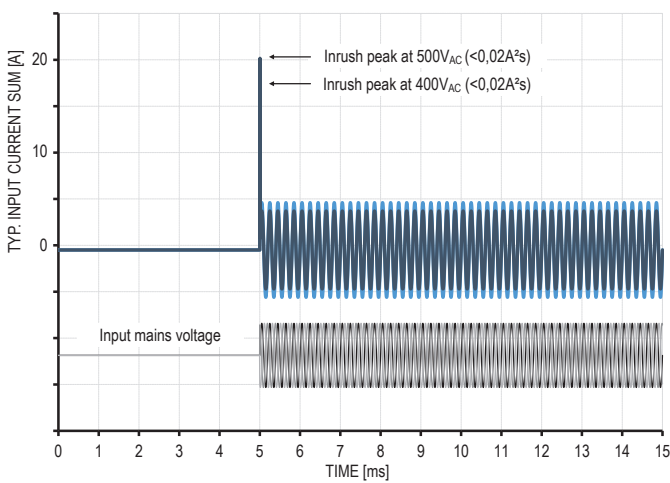

Fig. 6: Inrush current and energy during start-up phase

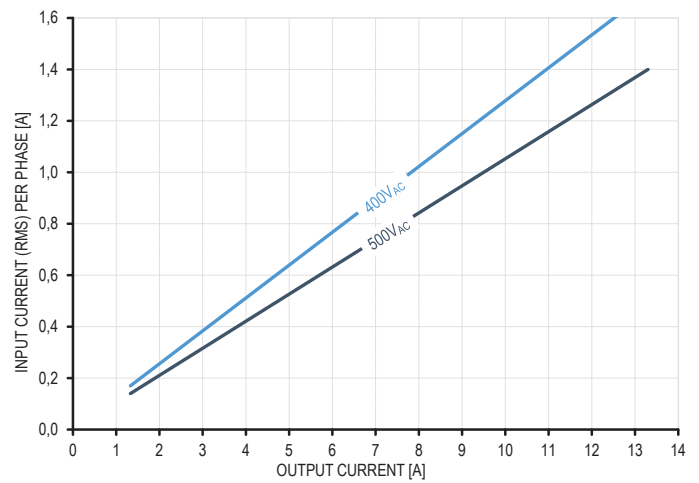

Fig. 7: Typical input current per phase in dependence of the load current

## 4. Performance

<b>Output power</b> [P <sub>out_nom</sub> ]	<i>nom.</i>	960W	
<b>Boost power 1</b> [P <sub>out_boost1</sub> ]	<i>max.</i>	1440W / 5s	<55°C <sub>amb</sub> , 100% P <sub>out_nom</sub> , 280 .. 575V <sub>AC</sub>
<b>Boost power 2</b> [P <sub>out_boost2</sub> ]	<i>max.</i>	1440W / 7s	<55°C <sub>amb</sub> , 100% P <sub>out_nom</sub> , 280 .. 575V <sub>AC</sub>
<b>Duty cycle 1</b>	<i>max.</i>	0.07	See boost power 1
<b>Duty cycle 2</b>	<i>max.</i>	0.035	See boost power 2
<b>Dropped phase power</b>	<i>max.</i>	480W	2x350 .. 575V <sub>AC</sub> , not compliant with IEC/EN 61000-3-2 harmonic currents
<b>Apparent input power</b>	<i>typ.</i>	1061 / 1062VA	400 / 500V <sub>AC</sub>
<b>Active input power</b>	<i>typ.</i>	997 / 998W	400 / 500V <sub>AC</sub>
<b>Reactive input power</b>	<i>typ.</i>	362Var	
<b>Power factor</b>	<i>typ.</i>	0.94	
<b>Conversion efficiency</b>	<i>typ.</i>	96.3 / 96.2%	400 / 500V <sub>AC</sub> , 100% P <sub>out_nom</sub>
	<i>avg.*</i>	95.5 / 95.0%	400 / 500V <sub>AC</sub> , 25 .. 100% P <sub>out_nom</sub>
<b>Power losses</b>	<i>typ.</i>	36.9 / 37.9W	400 / 500V <sub>AC</sub> , 100% P <sub>out_nom</sub>
	<i>avg.*</i>	45.2 / 50.5W	400 / 500V <sub>AC</sub> , 25 .. 100% P <sub>out_nom</sub>
<b>No-load consumption</b>	<i>max.</i>	5.6W	0% P <sub>out_nom</sub>
<b>Stand-by consumption</b>	<i>max.</i>	2.0 / 2.3W	Inhibit status HIGH (see Fig. 23)

\*Average efficiency under 25%, 50%, 75% and 100% load conditions, according to eco-design requirements of EU commission regulation 2019/1782.

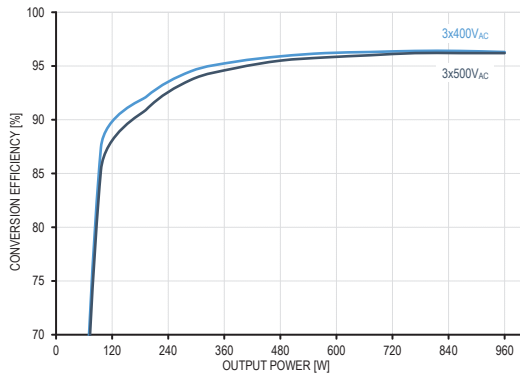

Fig. 8: Conversion efficiency in dependence of the output power

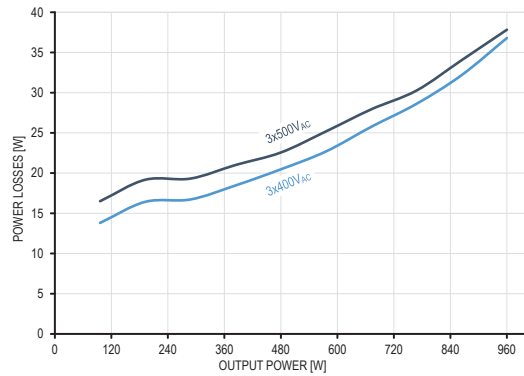

Fig. 9: Power losses in dependence of the output power

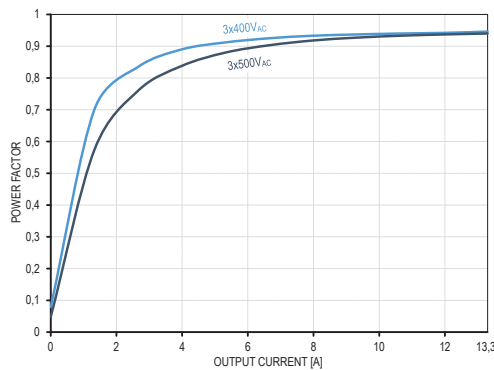

Fig. 10: Input power factor in dependence of the output current

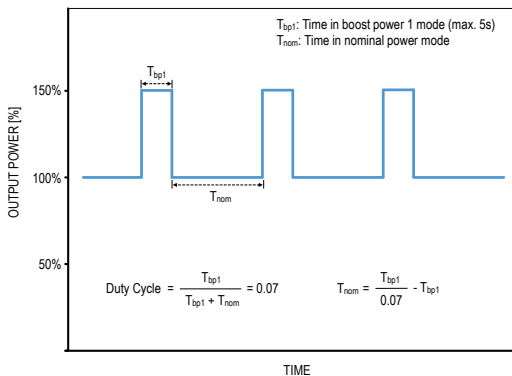

Fig. 11: Period and frequency of use of boost power 1 in normal mounting position

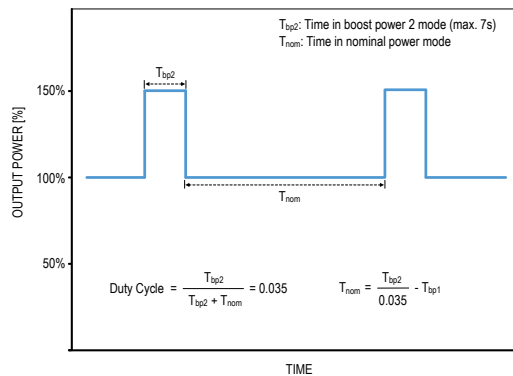

Fig. 12: Period and frequency of use of boost power 2 in normal mounting position

Unless otherwise stated, all values are specified in normal mounting position, at full load, nominal input and output voltages, 25°C (77°F) ambient temperature and a run-in time of 5 minutes.



## 5. Ambient conditions

<b>Ambient storage temperature</b>	<i>max.</i>	-40 .. +85°C <sub>amb</sub> (-40 .. +185°F <sub>amb</sub> )	
<b>Ambient operating temperature</b>	<i>max.</i>	-25 .. +70°C <sub>amb</sub> (-13 .. +158°F <sub>amb</sub> )	normal mounting position, >55°C <sub>amb</sub> (>131°F <sub>amb</sub> ) rotated ±90° around X or Y axis rotated 180°
	<i>nom.</i>	-25 .. +55°C <sub>amb</sub> (-13 .. +131°F <sub>amb</sub> )	
	<i>nom.</i>	-25 .. +40°C <sub>amb</sub> (-13 .. +104°F <sub>amb</sub> )	
	<i>nom.</i>	-25 .. +40°C <sub>amb</sub> (-13 .. +104°F <sub>amb</sub> )	
<b>Power derating*</b>	<i>min.</i>	6.24W/°C <sub>amb</sub> (3.47W/°F <sub>amb</sub> )	normal mounting position, >55°C <sub>amb</sub> (>131°F <sub>amb</sub> )
	<i>min.</i>	21.7W/°C <sub>amb</sub> (12.06W/°F <sub>amb</sub> )	rotated ±90° around X or Y axis, >39°C <sub>amb</sub> (>102.2°F <sub>amb</sub> )
	<i>min.</i>	21.7W/°C <sub>amb</sub> (12.06W/°F <sub>amb</sub> )	rotated 180°, >39°C <sub>amb</sub> (>102.2°F <sub>amb</sub> )
<b>Cooling concept</b>		Natural convection	
<b>Relative storage humidity</b> IEC 60068-2-30	<i>max.</i>	95%	non-condensing
<b>Relative operation humidity</b> IEC 60068-2-30	<i>max.</i>	95%	non-condensing
<b>Operating altitude</b>	<i>nom.</i>	3000mASL (9842ftASL)	not UL approved, reduced OVC
	<i>max.</i>	6000mASL (19685ftASL)	
<b>Percental power derating</b>	<i>min.</i>	5% per 1000m (5% per 3281ft)	>3000mASL (>9842ftASL)
<b>Temperature derating</b>	<i>min.</i>	5°C per 1000m (9°F per 3281ft)	>3000mASL (>9842ftASL)
<b>Atmospheric pressure</b>	<i>nom.</i>	689hPa	
	<i>max.</i>	469 .. 1070hPa	
<b>Pollution degree</b> IEC 60664-1, IEC 62477-1		2	
<b>Vibration sinusoidal</b> IEC 60068-2-6		2g / 10 .. 500Hz, 1 hour/direction X,Y,Z	mounted on DIN rail
<b>Shock test sinusoidal halfwave</b> IEC 60068-2-27		30g / 11ms ±5ms, 3 bumps/direction, 9 bumps total	mounted on DIN rail
<b>Audible noise</b>		Some audible noise may be heard during no load, overload or short circuit.	

\*Not actively controlled

**i** For altitudes above 3000mASL (9842ftASL) the next lower OVC must be considered.

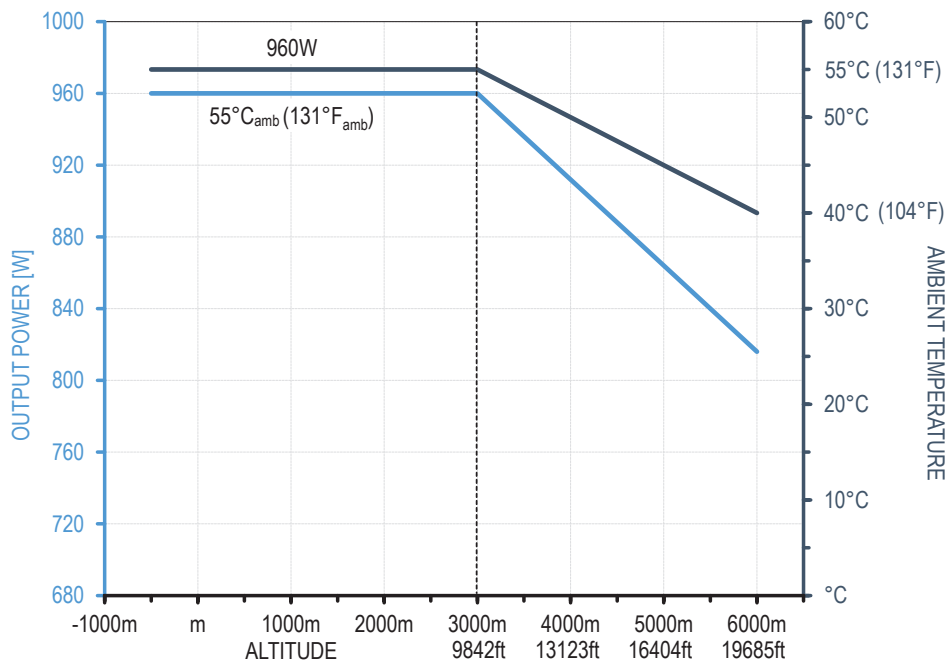

Fig. 13: Output power or ambient temperature derating at increasing altitudes

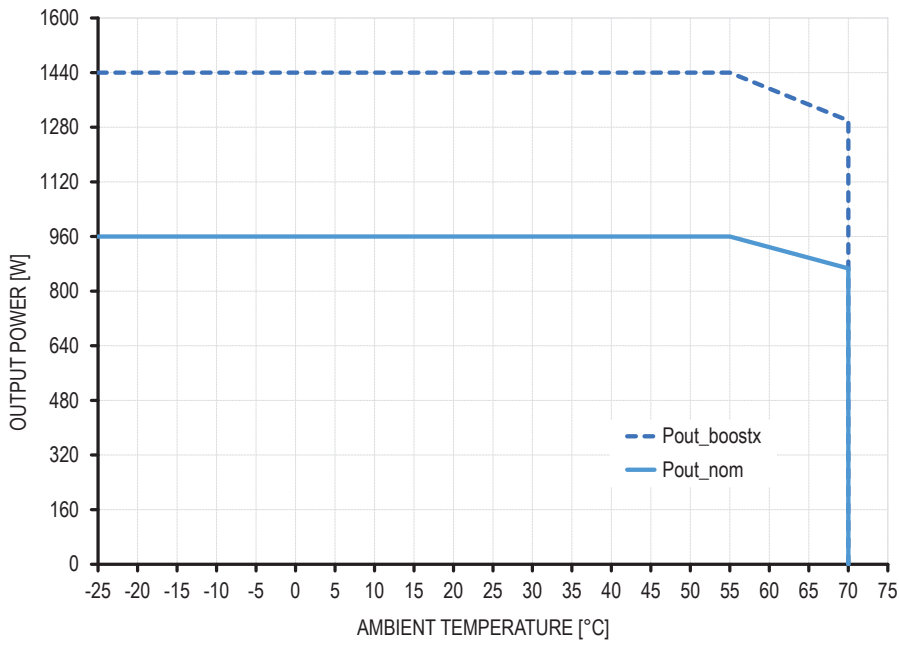

Fig. 14: Available output power in dependence of the ambient temperature for normal mounting position

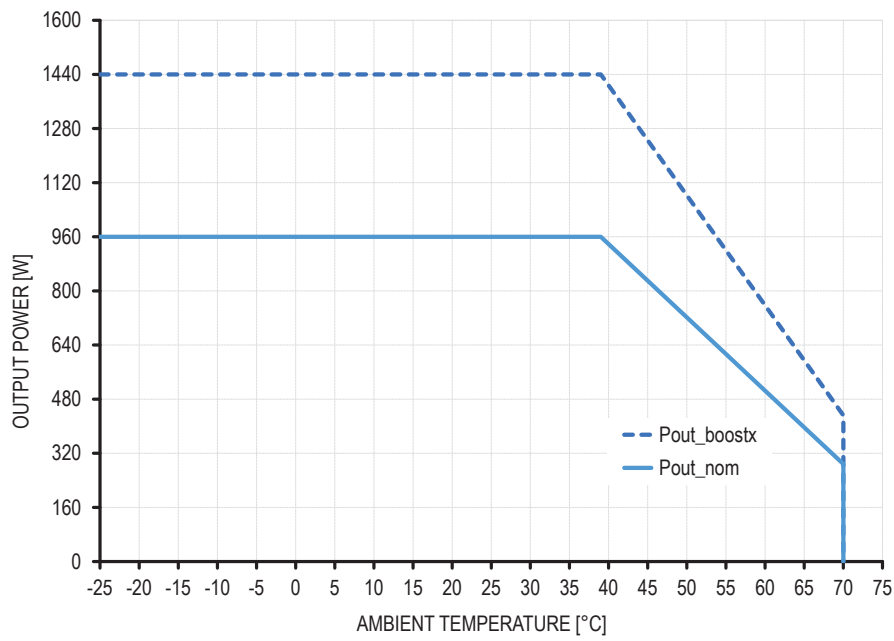
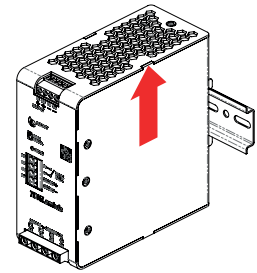
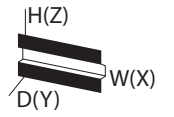
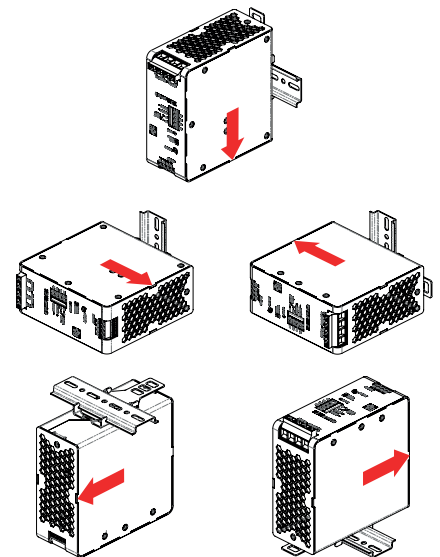



Fig. 15: Available output power in dependence of the ambient temperature for rotated mounting positions



Unless otherwise stated, all values are specified in normal mounting position, at full load, nominal input and output voltages, 25°C (77°F) ambient temperature and a run-in time of 5 minutes.

## 6. Reliability and Service lifetime

<b>Service lifetime</b>	<i>min.</i>	106 000 / 96 000hrs	400 / 500V <sub>AC</sub> , 100% P <sub>out_nom</sub> , 40°C <sub>Camb</sub> , 24/7
	<i>min.</i>	130 000 / 124 000hrs	400 / 500V <sub>AC</sub> , 75% P <sub>out_nom</sub> , 40°C <sub>Camb</sub> , 24/7
	<i>min.</i>	299 000 / 000hrs	400 / 500V <sub>AC</sub> , 100% P <sub>out_nom</sub> , 25°C <sub>Camb</sub> , 24/7
<b>Early life MTBF</b>	<i>min.</i>	0.76M / 0.70M / 0.60M hrs	25 / 40 / 55°C <sub>Camb</sub> , 50% P <sub>out_nom</sub>
Telcordia SR-332 Issue 4	<i>min.</i>	0.39M / 0.33M / 0.25M hrs	25 / 40 / 55°C <sub>Camb</sub> , 100% P <sub>out_nom</sub>
<b>Service life MTBF</b>	<i>min.</i>	3.80M / 2.80M / 1.70M hrs	25 / 40 / 55°C <sub>Camb</sub> , 50% P <sub>out_nom</sub>
Telcordia SR-332 Issue 4	<i>min.</i>	0.67M / 0.51M / 0.34M hrs	25 / 40 / 55°C <sub>Camb</sub> , 100% P <sub>out_nom</sub>

 The maximum service lifetime guaranteed by the eCap manufacturer is 131 400hrs (15 years). All values above are theoretically calculated.

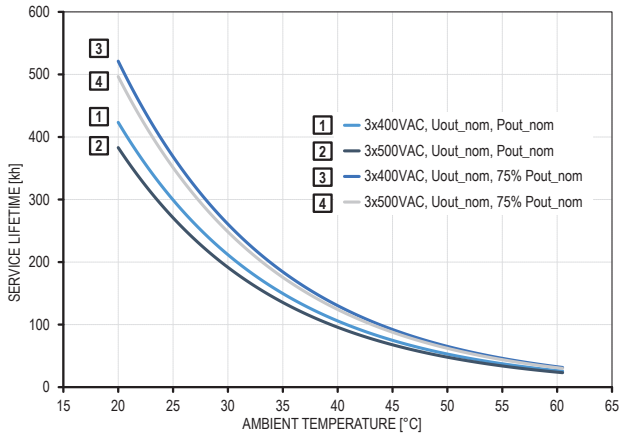

Fig. 16: Power supply service lifetime in dependence of ambient temperature

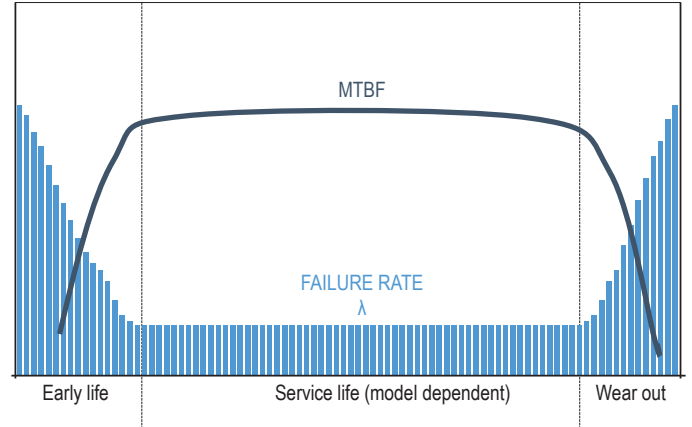

Fig. 17: Generic diagram visualising failure rate and MTBF values during the products life-cycle

## 7. Dimensions & Mechanical data

<b>Enclosure material</b>	Aluminum	
<b>Cover material</b>	Aluminum	
<b>Inflammability class</b>	V0	incl. connection terminals
UL 94		
<b>Width</b>	100.0mm (3 <sup>15</sup> /16in)	
<b>Height</b>	129.0mm (5 <sup>5</sup> /64in)	
<b>Depth</b>	w/o DIN rail	
Screw terminal model (-A0)	169.1mm (6 <sup>21</sup> /32in)	
Push-in terminal model (-A1)	171.9mm (6 <sup>49</sup> /64in)	
<b>Weight</b>	1750g (3.86lb)	
<b>Lever arm</b>	<i>max.</i>	85mm (3 <sup>11</sup> /32in) into the direction of Y axis
<b>Torsional moment on DIN rail</b>	<i>max.</i>	1.46Nm (12.92lb in) into the direction of Z axis
<b>Enclosure openings</b>	<i>max.</i>	7mm (9/32in)
<b>DIN rail types</b>	TH 35-7.5, TH 35-15	
IEC 60715		

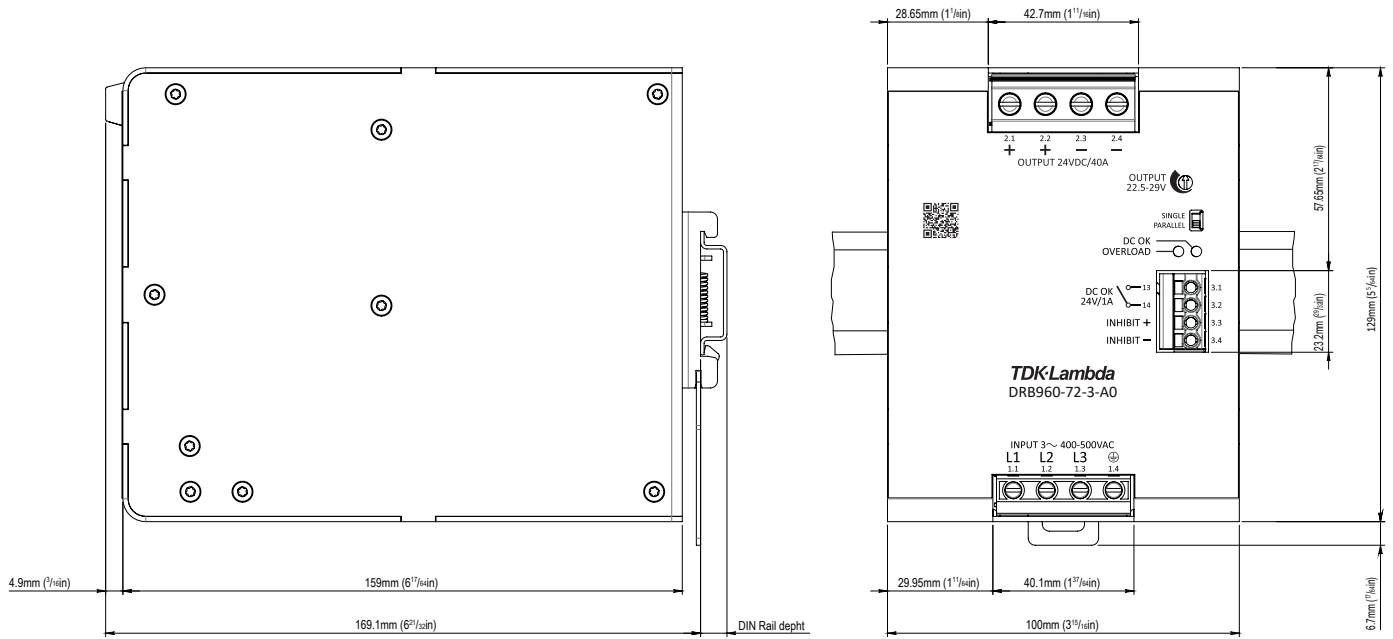

Fig. 18: Dimension drawing of DRB960-72-3-A0

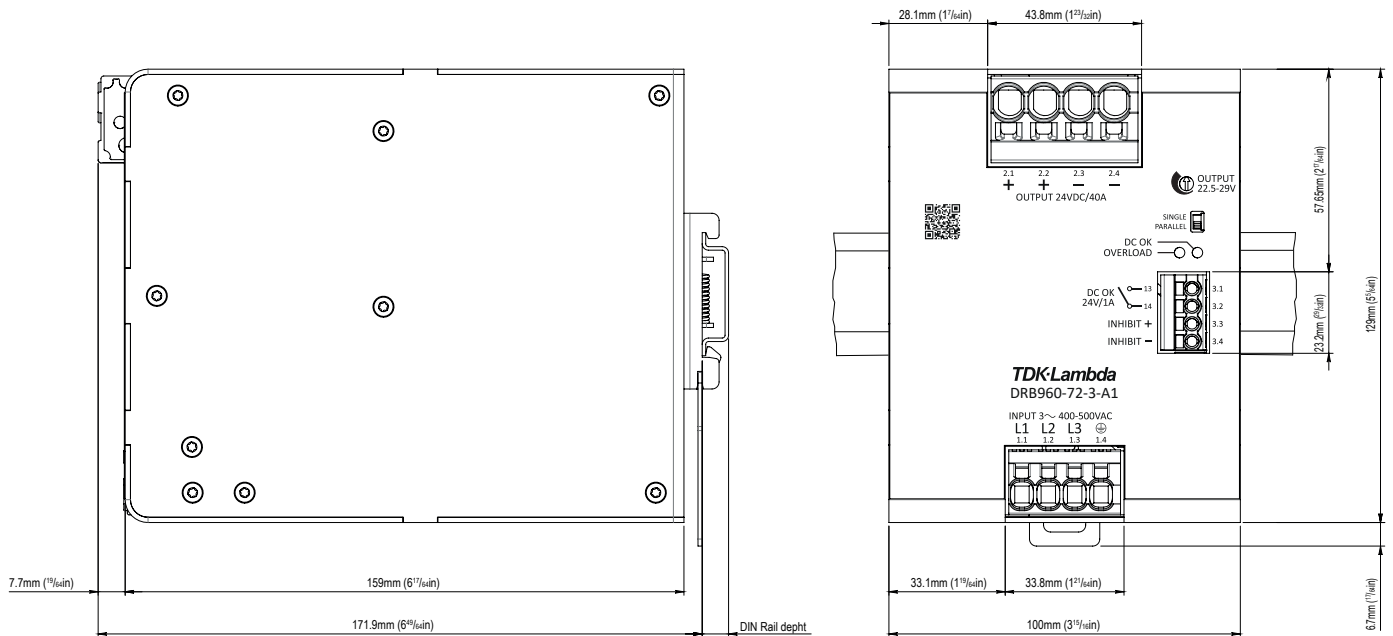

Fig. 19: Dimension drawing of DRB960-72-3-A1

## 8. Installation clearances

### Vertically (Z axis)

Top side	<b>1</b>	min.	40mm ( $1^{37}/64$ in)
Bottom side	<b>2</b>	min.	20mm ( $2^5/32$ in)

installation above heat sources not permitted

### Horizontally (X axis)

Left side / Right side	<b>3a</b> <b>4a</b>	min.	5mm ( $1^3/64$ in)
Left side / Right side	<b>3b</b> <b>4b</b>	min.	2mm ( $5/64$ in)

to heat sources (same power rating) to passive components

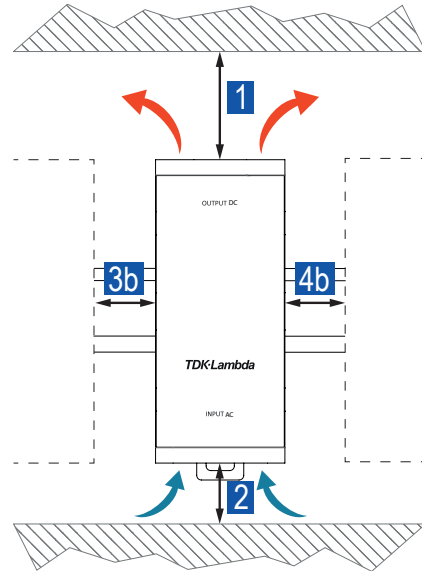
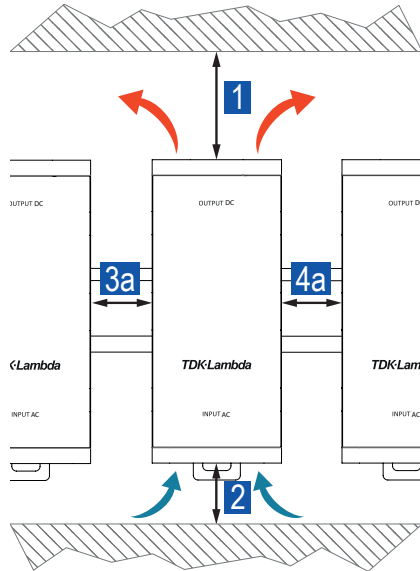

Fig. 20: Installation clearances to heat sources

Fig. 21: Installation clearances to passive components

## 9. Wiring & Connection

### DRB960-72-3-A0

Terminal type  
Recommended screw driver

Solid wire  
Flexible wire  
Standard ferrules  
Uninsulated ferrules  
Stripping length  
Tightening torque

### Input

Slotted screw  
SL 0.8x4.0mm  
(SL  $1/32 \times 9/32$ in)  
0.5-4.0mm<sup>2</sup> (26-10AWG)  
0.5-4.0mm<sup>2</sup> (26-10AWG)  
0.25-2.5mm<sup>2</sup>  
0.25-2.5mm<sup>2</sup>  
6-7mm ( $1^5/64 - 9/32$ in)  
0.5-0.8Nm (4.4-7.0lb in)

### Output

Slotted screw  
SL 0.8x4.0mm  
(SL  $1/32 \times 9/32$ in)  
0.5-10.0mm<sup>2</sup> (22-6AWG)  
0.5-10.0mm<sup>2</sup> (22-6AWG)  
0.25-10.0mm<sup>2</sup>  
0.25-10.0mm<sup>2</sup>  
11-12mm ( $7/16 - 1^5/32$ in)  
1.8-2.0Nm (15.9-17.7lb in)

### Signaling

Push-in  
SL 0.5x3.0mm  
(SL  $1/64 \times 1/8$ in)  
0.2-2.5mm<sup>2</sup> (26-12AWG)  
0.2-2.5mm<sup>2</sup> (26-12AWG)  
0.2-1.5mm<sup>2</sup>  
0.2-2.5mm<sup>2</sup>  
9-10mm ( $2^3/64 - 2^5/64$ in)  
-

### DRB960-72-3-A1

Terminal type  
Recommended screw driver

Solid wire  
Flexible wire  
Standard ferrules  
Uninsulated ferrules  
Stripping length

Push-in  
SL 0.6x3.5mm  
(SL  $1/32 \times 9/64$ in)  
0.2-10.0mm<sup>2</sup> (24-8AWG)  
0.2-6.0mm<sup>2</sup> (24-8AWG)  
0.25-4.0mm<sup>2</sup>  
0.25-6.0mm<sup>2</sup>  
15mm ( $1^9/32$ in)

Push-in  
SL 1.0x5.5mm  
(SL  $3/64 \times 7/32$ in)  
0.75-16.0mm<sup>2</sup> (20-4AWG)  
0.75-16.0mm<sup>2</sup> (20-4AWG)  
0.75-10.0mm<sup>2</sup>  
0.75-16.0mm<sup>2</sup> (20-4AWG)  
18-20mm ( $4^5/64 - 2^5/32$ in)

Push-in  
SL 0.5x3.0mm  
(SL  $1/64 \times 1/8$ in)  
0.2-2.5mm<sup>2</sup> (26-12AWG)  
0.2-2.5mm<sup>2</sup> (26-12AWG)  
0.2-1.5mm<sup>2</sup>  
0.2-2.5mm<sup>2</sup>  
9-10mm ( $2^3/64 - 2^5/64$ in)

**i** In compliance to IEC/EN/UL 62368-1 (Ed.2) ferrules are required if flexible wires are used. In compliance with IEC/EN/UL 61010-1, 61010-2-201 appropriate copper wires must be used that withstand operating temperatures of at least 75°C (167°F) in ambients NOT exceeding 40°C (104°F), and 90°C (194°F) in ambients exceeding 40°C (104°F).

## 10. Signaling & Control

### DC OK

Type		Relay contact	
Characteristic		N/O	
Closing		$U_{out} > 95\% U_{set}$	duration min. 100ms
Opening		$U_{out} < 85\% U_{set}$	duration min. 100ms
Resistive load	<i>nom.</i>	1A	24V <sub>DC</sub>
	<i>max.</i>	0.5A	60V <sub>DC</sub>
Trigger hysteresis	<i>typ.</i>	0.6V	

### Remote ON/OFF

Type		Electrical contact	
Characteristic		Inhibit	
ON threshold	<i>typ.</i>	3V	
OFF threshold	<i>typ.</i>	4.5V	
Restart delay	<i>max.</i>	6s	
Input voltage	<i>max.</i>	30V	
Input current	<i>max.</i>	10mA	
Reference potential		Isolated	
Parallel connection		yes	
Active discharging		no	

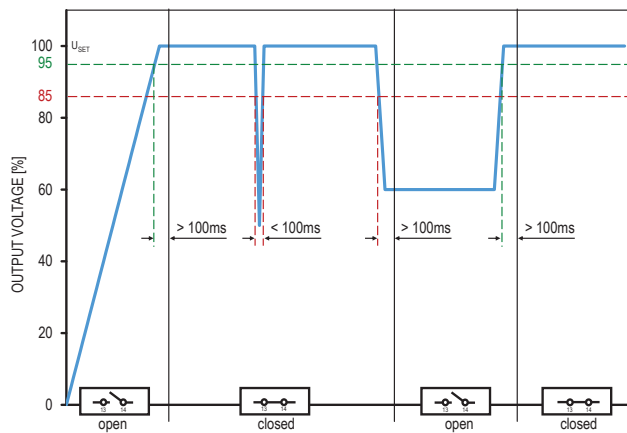

Fig. 22: DC-OK relay characteristic in dependence of output voltage changes

### OFF mode

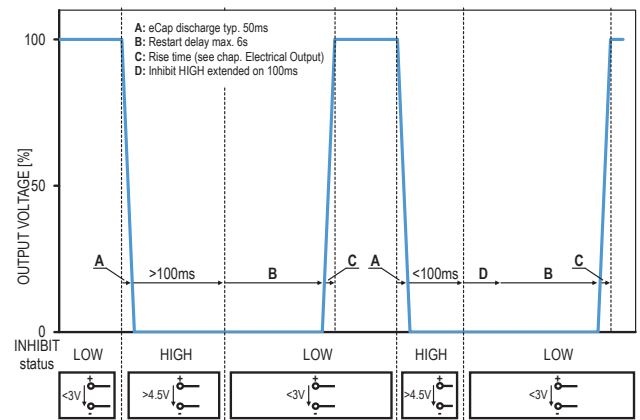

Fig. 23: Control of the output voltage in dependence of the inhibit relay status.

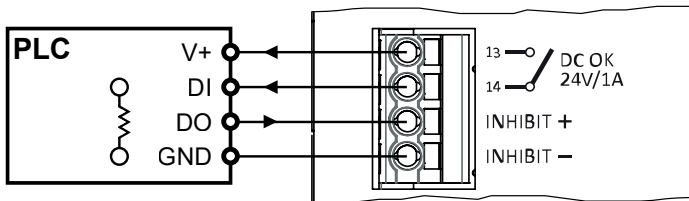
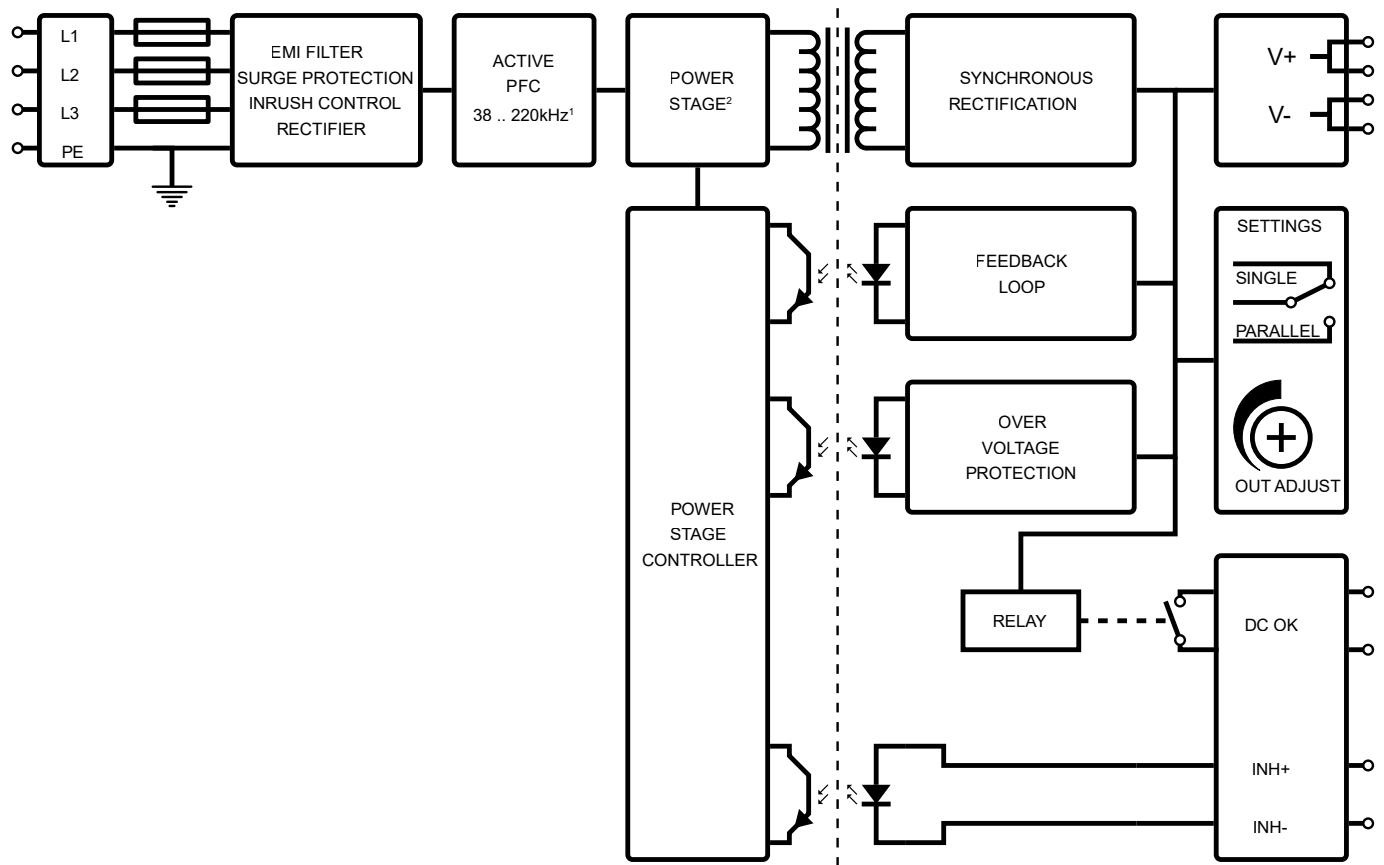

Fig. 24: Generic connection diagram of DC OK and INHIBIT contacts

## 11. Block diagram



<sup>1</sup>Dependent on  $U_{in}$  and  $I_{out}$

<sup>2</sup>Dependent on  $U_{out}$  and  $I_{out}$

## 12. Device protection

<b>Ingress protection degree</b> IEC 60529	IP 20	
<b>NEMA classification</b> NEMA 250-2018	NEMA 1	
<b>Output overtemperature protection (OTP)</b>	Yes, with auto-recovery	
<b>Output overvoltage protection (OVP)</b>	<i>max.</i>	91.5V <sub>DC</sub> , with auto-recovery
<b>Undervoltage protection threshold (UVP)</b>	<i>max.</i>	300V <sub>AC</sub>
<b>Output overcurrent protection (OCP)</b>	<i>min.</i>	152%, with auto-recovery
<b>Integrated input fuse</b>	3x T5A at L pins	not DC capable, not user replaceable
<b>Suitable MCB types</b> IEC 60898-1, UL 1077	B or C characteristic, 6/8/10A	
<b>Transient protection</b>		
1st level	MOV (Metal Oxide Varistor)	
2nd level	GDT (Gas Discharge Tube)	

**i** When installed in an end-product, the maximum branch circuit rating must not exceed 20A (IEC/UL 62368-1 Ed.2). If the upstream supply provides a higher ampacity than 20A, an external protection device is required.

### 13. Electrical Safety

<b>Class of protection</b> IEC 61140	I	PE connection required
<b>Electrical energy source classification</b> IEC 62368-1	ES2	
<b>Safety Extra Low Voltage</b> IEC 61010-2-201, IEC 60950-1	Not compliant	
<b>Protective Extra Low Voltage</b> IEC 60204-1	Not compliant	
<b>Protective ground resistance</b>	<i>max.</i> 100mΩ	
<b>Ground leakage current</b> IEC 60990	<i>max.</i> 0.9mA <i>max.</i> 1.0mA	TN/TT mains, 3x575V <sub>AC</sub> , 50Hz TN/TT mains, 3x575V <sub>AC</sub> , 60Hz
<b>Touch current</b> IEC 60990	<i>max.</i> 40μA <i>max.</i> 50μA	TN/TT mains, 3x575V <sub>AC</sub> , 50Hz TN/TT mains, 3x575V <sub>AC</sub> , 60Hz
<b>Overvoltage category</b> IEC 61010-1, IEC 62368-1 (Ed.2)	II	< 3000mASL (< 9842ftASL)

#### 13.1 Overvoltage category design

Underlying IEC standard	61010-1	62368-1 <sup>1)</sup>	60950-1	61558-2-16 <sup>2)</sup>	62477-1	61204-7	60664-1
Mains transient voltage	II	II	II	III	III	III	III
Creepage & Clearance	III	II	III	II	III	III	III

<sup>1)</sup>Edition 2

<sup>2)</sup> not applicable along with IEC 61204-7

#### 13.2 Insulation strength

		Type test (60s) IEC 61010-1	Routine test (3s) IEC 61010-1	Field test (3s)
Input / Output	<b>A</b>	3510V <sub>AC</sub>	3510V <sub>AC</sub>	3510V <sub>AC</sub>
Input / PE	<b>B</b>	2210V <sub>AC</sub>	2210V <sub>AC</sub>	2210V <sub>AC</sub>
Input / DC OK	<b>C</b>	3510V <sub>AC</sub>		3510V <sub>AC</sub>
Input / INHIBIT	<b>D</b>	3510V <sub>AC</sub>		3510V <sub>AC</sub>
Output / PE	<b>E</b>	1390V <sub>AC</sub>	1390V <sub>AC</sub>	1390V <sub>AC</sub>
Output / DC OK	<b>F</b>	1390V <sub>AC</sub>		1390V <sub>AC</sub>
Output / INHIBIT	<b>G</b>	1390V <sub>AC</sub>		1390V <sub>AC</sub>
DC OK / INHIBIT	<b>H</b>	1390V <sub>AC</sub>		1390V <sub>AC</sub>

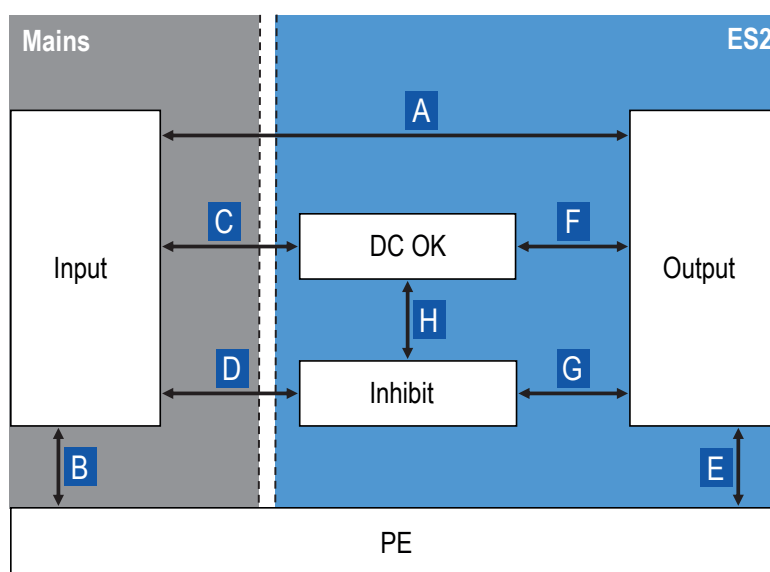

Fig. 25: Schematic of the insulation paths



### 13.3 HIPOT test

Apart from routine and type test, the end user might need to check the insulation strength during the final inspection and testing to guarantee the electrical safety of the end application. Therefore, a high-voltage test (HIPOT test) can be performed in the field. The following conditions must be observed:

- ▶ As every HIPOT test causes stress on the power supplies safety insulation, avoid frequent HIPOT testing or excessive test voltages
- ▶ The test voltages and durations, as indicated under „13.2 Insulation strength“ on page 16, must not be exceeded
- ▶ The test voltages rise and fall time should be between 2 and 4 seconds
- ▶ For the HIPOT test of the insulation path (B) between Input and PE, the gas discharge tube (GDT) must be disconnected

#### Disconnection of the GDT:

- 1) Completely remove the connection screw (marked with an arrow) with a Torx X10. (see Fig. 26)
- 2) Keep the screw in a safe place.
- 3) After completion of testing, reconnect the GDT only with the original screw to avoid risk of electrical shock or damage.
- 4) Fasten the screw with a Torx X10 not exceeding a tightening torque of 0.7 Nm.

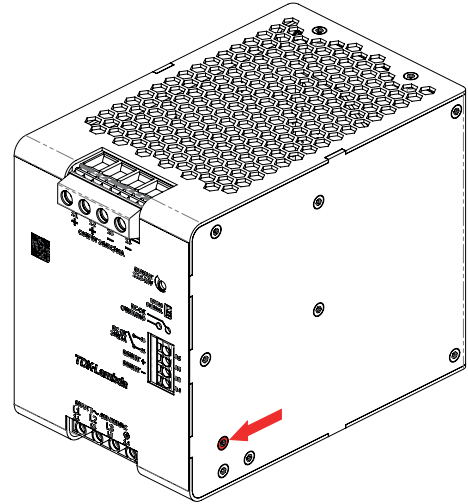

Fig. 26: Position of the connection screw for the GDT

**i** According to EN 60204-1 (Safety of machinery - Electrical equipment of machines), an individual HIPOT test of the power supply isn't required. During the HIPOT test of the end application, the power supply can be disconnected and only installed once the test has been completed.

## 14. Electromagnetic immunity

Investigated under generic standards IEC/EN 61000-6-2 (2019) - Immunity for industrial environments.

<b>Electrostatic contact discharge</b> IEC/EN 61000-4-2	4kV	Criterion A	330Ω / 150pF
<b>Electrostatic air discharge</b> IEC/EN 61000-4-2	8kV	Criterion A	330Ω / 150pF
<b>Electromagnetic RF field<sup>1)</sup></b> IEC/EN 61000-4-3	10V/m 3V/m 1V/m	Criterion A Criterion A Criterion A	80MHz..1GHz 1.4GHz..2GHz 2GHz..2.7GHz
<b>Fast transients (burst)</b> IEC/EN 61000-4-4			
Input <sup>2)</sup>	4kV	Criterion A	5kHz
Output	2kV	Criterion A	5kHz
Signal contact <sup>2)</sup>	2kV	Criterion A	5kHz
<b>Surge voltages</b> IEC/EN 61000-4-5			
Input symmetrical (L-L) <sup>2)</sup>	2kV	Criterion A	2Ω+18μF, for φ = 0°,90°,180°,270°
Input asymmetrical (L-PE) <sup>2)</sup>	4kV	Criterion A	12Ω+9μF, for φ = 0°,90°,180°,270°
Output symmetrical (L-L)	0.5kV	Criterion A	2Ω+18μF
Output asymmetrical (L-PE)	1kV	Criterion A	12Ω+9μF
Signal line asymmetrical (Signal-PE)	1kV	Criterion A	42Ω+0.5μF
<b>Conducted disturbances Input, signal line, PE<sup>3)</sup></b> IEC/EN 61000-4-6	10V	Criterion A	150kHz..80MHz
<b>Power frequency magnetic field</b> IEC/EN 61000-4-8	30A/m	Criterion A	50Hz, 60s each axis (x, y, z)
<b>Voltage dips/sags and interruptions</b> IEC/EN 61000-4-11, 61000-4-34, SEMI F47-0706	500ms 200ms 20ms 5000ms	Criterion A Criterion B Criterion A Criterion C	400VAC at 70%, 50Hz 400VAC at 40%, 50Hz 400VAC at 0%, 50Hz 400VAC at 0%, 50Hz

<sup>1)</sup> Except for the ITU broadcast frequency bands 87..107MHz, 174..230MHz and 470..790MHz, where the level shall be 3V/m.

<sup>2)</sup> Exceeds the requirements of the European Low Voltage Directive 2014/35/EU

<sup>3)</sup> Except for the ITU broadcast frequency bands 47..68MHz, where the level shall be 3V.

### Performance level definitions:

#### Criterion A:

The device continues operation as intended during and after the test. The specified performance level accepts a change of ±10% on nominal output voltage and current. There is neither a violation of the performance level, nor a loss of function if the device is used as intended.

#### Criterion B:

The device continues operation as intended after the test. The specified performance level accepts a change of ±10% on nominal output voltage and current. There is neither a violation of the performance level, nor a loss of function if the device is used as intended. During the test a violation of the performance level is allowed.

#### Criterion C:

A temporary loss of function is allowed, provided the function is auto-recoverable, or can be restored by the operation of the controls.



## 15. Electromagnetic emission

Investigated under generic standards IEC/EN 61000-6-3 (2007) + A1 (2011) / AC (2012) - Emission standard for residential, commercial and light-industrial environments.

<b>Conducted noise emission input</b> EN 55011, CISPR 11	Class B	150kHz..30MHz
<b>Radiated noise emission input</b> EN 55011, CISPR 11	Class B	30MHz..1GHz
<b>Harmonic currents input</b> IEC/EN 61000-3-2	Class A	0kHz..2kHz
<b>Total harmonic distortion (THD) input</b> IEC/EN 61000-3-2	35% per phase	Order 1..40
<b>Voltage changes, voltage fluctuations and flicker Input</b> IEC/EN 61000-3-3	PASS	50Hz

Unless otherwise stated, all values are specified in normal mounting position, at full load, nominal input and output voltages, 25°C (77°F) ambient temperature and a run-in time of 5 minutes.

## 16. Certifications & Approvals







	UL 61010-1 CAN/CSA-C22.2 No. 61010-1	Safety requirements for electrical equipment for measurement, control, and laboratory use - Part 1: General requirements
	UL 61010-2-201 CAN/CSA-C22.2 No. 61010-2-201	Safety requirements for electrical equipment for measurement, control, and laboratory use - Part 2-201: Particular requirements for control equipment UL file: E356563
	IEC EN 61010-1	Safety requirements for electrical equipment for measurement, control, and laboratory use - Part 1: General requirements
	IEC EN 61010-2-201	Safety requirements for electrical equipment for measurement, control, and laboratory use - Part 2-201: Particular requirements for control equipment
	IEC EN 62368-1 (Ed.2)	Audio/video, information and communication technology equipment - Part 1: Safety requirements
	UL 62368-1 (Ed. 2)	Audio/video, information and communication technology equipment - Part 1: Safety requirements UL file: E511889

## 17. Designed to meet

The safety design of the product complies additionally with the following harmonised standards.

IEC 60950-1	Information technology equipment - Safety - Part 1: General requirements
IEC/EN 62477-1	Safety requirements for power electronic converter systems and equipment - Part 1: General
IEC/EN 61204-7	Low-voltage switch mode power supplies - Part 7: Safety requirements
IEC/EN 61558-2-16	Safety of transformers, reactors, power supply units and similar products for supply voltages up to 1100 V - Part 2-16: Particular requirements and tests for switch mode power supply units and transformers for switch mode power supply units
EN 60204-1	Safety of machinery - Electrical equipment of machines - Part 1: General requirements

## 18. Compliance & Registration

	Conformity with health, safety, and environmental protection standards for products sold within the European Economic Area (EEA).
	UKCA (UK Conformity Assessed) is the product marking that is used for certain goods being placed on the United Kingdom market.
	Registration mark to indicate products conformity to the technical regulations of the Eurasian Customs Union (Russia, Belarus, Armenia, Kazakhstan and Kyrgyzstan).
	The Waste Electrical and Electronic Equipment Directive (WEEE Directive) is the European Community Directive 2012/19/EU on collection, recycling and recovery targets for all types of electrical goods.
	The Restriction of Hazardous Substances Directive 2011/65/EU (RoHS 2) regulates the use of certain hazardous substances in electrical and electronic equipment.
	Registration, Evaluation, Authorisation and Restriction of Chemicals (REACH) is a European Union regulation that addresses the production and use of chemical substances, and their potential impacts on both human health and the environment.

Unless otherwise stated, all values are specified in normal mounting position, at full load, nominal input and output voltages, 25°C (77°F) ambient temperature and a run-in time of 5 minutes.

## 19. Typical use-cases

### 19.1 Parallel Operation

For the purpose of power increase, power supplies can be paralleled. Furthermore, a paralleling can be done for limited redundancy purposes in order to backup malfunctions occurring on the primary (AC) side of the power supplies. The following measures must be taken into account:

- ▶ Only power supplies of the same series and power rating must be paralleled
- ▶ The dip switch on the front side of the power supplies must be switched to 'Parallel'
- ▶ Load wiring shall be identical in terms of length and cross section
- ▶ The output voltage of the power supplies shall be adjusted to the same value ( $\pm 100\text{mV}$ )
- ▶ All paralleled power supplies must be operated under the same ambient conditions
- ▶ The power supplies must not be operated under any condition which requires a power derating (e.g. altitudes above 3000mASL (9842ftASL), temperatures above  $55^\circ\text{C}_{\text{amb}}$  ( $131^\circ\text{F}_{\text{amb}}$ ), mounting orientations others than the normal mounting position, etc.)
- ▶ If more than three power supplies are paralleled, each output must be protected by a decoupling module, MCB, diode, or fuse
- ▶ The increased installation clearances must be considered (see „8. Installation clearances“ on page 13)

**i** In parallel operations the values of output load regulation, inrush currents, EMI, harmonic and leakage currents will increase.

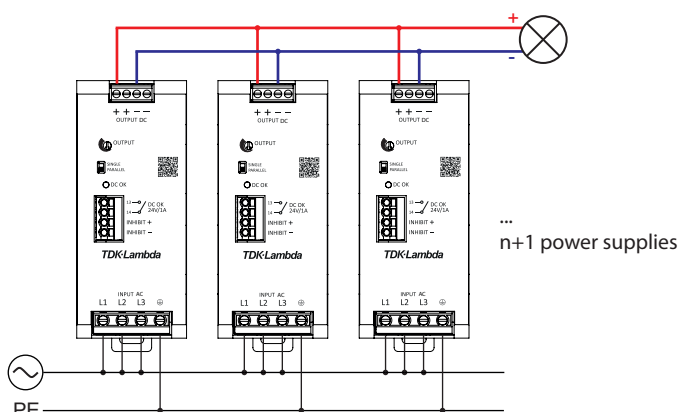

Fig. 27: Connection scheme of n+1 power supplies paralleled for the purpose of power increase

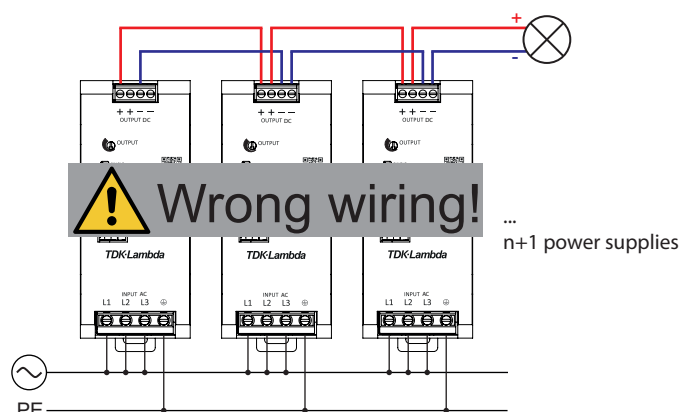

Fig. 28: Example of a wrong connection scheme

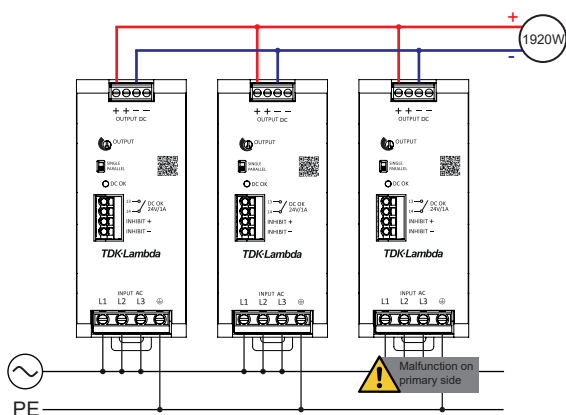

Fig. 29: Connection scheme of n+1 power supplies paralleled for the purpose of a 1920W limited redundancy

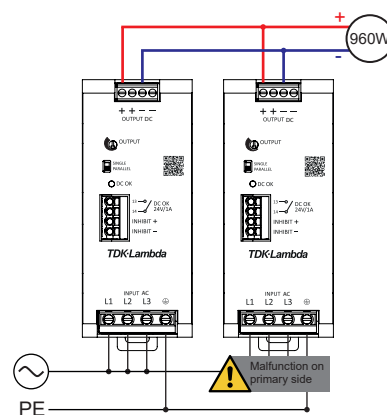

Fig. 30: Connection scheme of 1+1 power supplies paralleled for the purpose of a 960W limited redundancy

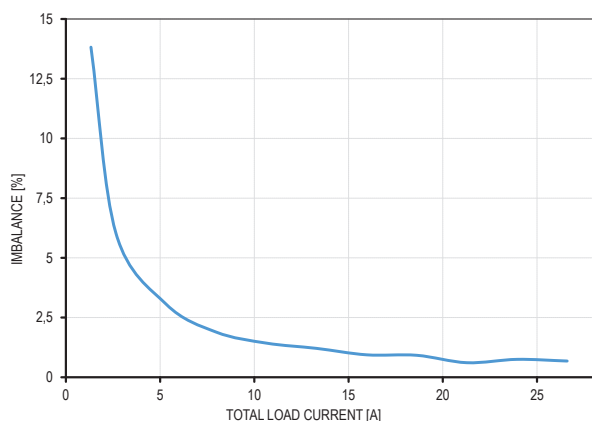

Fig. 31: Typical load sharing behaviour of two power supplies in parallel mode

Unless otherwise stated, all values are specified in normal mounting position, at full load, nominal input and output voltages,  $25^\circ\text{C}$  ( $77^\circ\text{F}$ ) ambient temperature and a run-in time of 5 minutes.

## 19.2 Series operation

For the purpose of higher load voltages, power supplies can be connected in series. The following measures must be taken into account:

- ▶ The output voltage sum must not exceed 250V<sub>DC</sub>
- ▶ If the output voltage sum exceeds 60V<sub>DC</sub>, a safeguard against unintended touching must be considered
- ▶ Only power supplies of the same series and power rating must be connected in series
- ▶ The dip switch on the front side of the power supplies must be switched to SINGLE
- ▶ All power supplies in series must be operated under the same ambient conditions
- ▶ The power supplies must not be operated under any condition which requires a power derating (e.g. altitudes above 3000mASL (9842ftASL), temperatures above 55°C<sub>amb</sub> (131°F<sub>amb</sub>), mounting orientations others than the normal mounting position, etc.)
- ▶ The increased installation clearances must be considered (see „8. Installation clearances“ on page 13)

**i** In series operations the values of output load regulation, inrush currents, EMI, harmonic and leakage currents will increase.

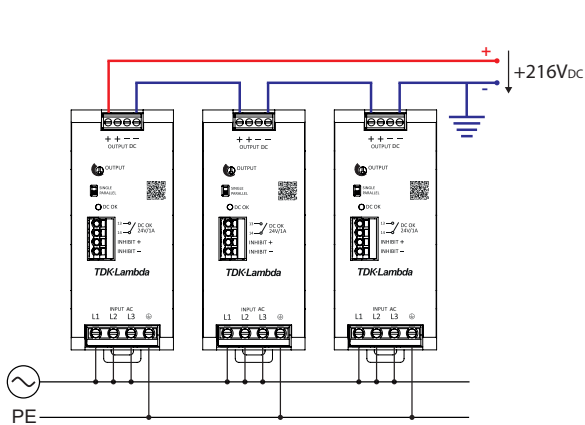

Fig. 32: Connection scheme for series operation with positive voltage level

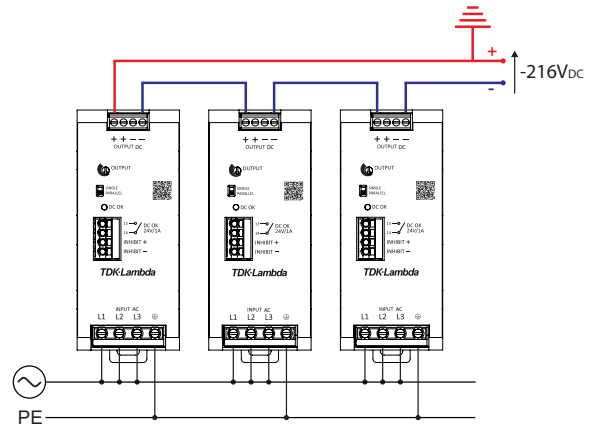

Fig. 33: Connection scheme for series operation with negative voltage level

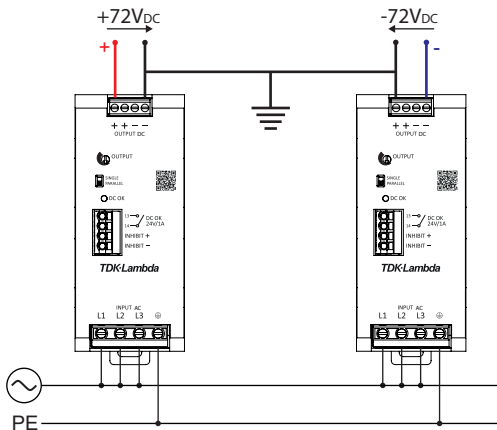

Fig. 34: Connection scheme for series operation with centre tap

### 19.3 Two-phase operation

The device is capable to run continuously on two phases of a 3-phase power grid. A power derating of min. 50% is required under nominal conditions. All conditions associated with a power derating must be carefully considered.

Please note if running on two phases:

- ▶ Power losses will increase and can no longer be guaranteed as specified for 3-phase operation
- ▶ Hold-up times as specified for 3-phase operation can no longer be guaranteed
- ▶ The device will go into OTP mode if operating permanently at input voltages below 350V<sub>AC</sub>
- ▶ The device is no more compliant with IEC/EN 61000-3-2 harmonic current limits
- ▶ Safety approvals under UL 61010-1, -2-201 and UL 62368-1 (Ed.2) are no more applicable

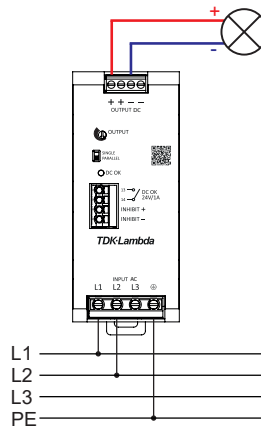

Fig. 35: Connection diagram for 2-phase operation



## TDK-Lambda France SAS

Tel: +33 1 60 12 71 65  
tff.fr-powersolutions@tdk.com  
www.emea.lambda.tdk.com/fr



## Italy Sales Office

Tel: +39 02 61 29 38 63  
tff.it-powersolutions@tdk.com  
www.emea.lambda.tdk.com/it



## Netherlands

tff.nl-powersolutions@tdk.com  
www.emea.lambda.tdk.com/nl



## TDK-Lambda Germany GmbH

Tel: +49 7841 666 0  
tfg.powersolutions@tdk.com  
www.emea.lambda.tdk.com/de



## Austria Sales Office

Tel: +43 2256 655 84  
tfg.at-powersolutions@tdk.com  
www.emea.lambda.tdk.com/at



## Switzerland Sales Office

Tel: +41 44 850 53 53  
tfg.ch-powersolutions@tdk.com  
www.emea.lambda.tdk.com/ch



## Nordic Sales Office

Tel: +45 8853 8086  
tfg.dk-powersolutions@tdk.com  
www.emea.lambda.tdk.com/dk



## TDK-Lambda UK Ltd.

Tel: +44 (0) 12 71 85 66 66  
tlu.powersolutions@tdk.com  
www.emea.lambda.tdk.com/uk



## TDK-Lambda Ltd.

Tel: +9 723 902 4333  
tli.powersolutions@tdk.com  
www.emea.lambda.tdk.com/il-en



## TDK-Lambda Americas

Tel: +1 800-LAMBDA-4 or 1-800-526-2324  
tla.powersolutions@tdk.com  
www.us.lambda.tdk.com



## TDK Electronics do Brasil Ltda

Tel: +55 11 3289-9599  
sales.br@tdk-electronics.tdk.com  
www.tdk-electronics.tdk.com/en



## TDK-Lambda Corporation

Tel: +81-3-6778-1113  
www.jp.lambda.tdk.com



## TDK-Lambda (China) Electronics Co. Ltd.

Tel: +86 21 6485-0777  
tlc.powersolutions@tdk.com  
www.lambda.tdk.com.cn



## TDK-Lambda Singapore Pte Ltd.

Tel: +65 6251 7211  
tfs.marketing@tdk.com  
www.sg.lambda.tdk.com



## TDK India Private Limited, Power Supply Division

Tel: +91 80 4039-0660  
mathew.philip@tdk.com  
www.sg.lambda.tdk.com

For further information please visit:  
[emea.lambda.tdk.com/dr3-3-phase](http://emea.lambda.tdk.com/dr3-3-phase)

