

LED Flood Light IP65– 10W

Authorized Licensee for TOSHIBA trademark



1. Specification:

A. General Data

Model	LED Flood Light 10W			
P/N(Black shell)	DELL-FL34010C5A011	DELL-FL44010C5A011	DELL-FL54010C5A011	DELL-FLC4010C5A011
Westnet Code	00172831	00172830	00172829	00172828
P/N(White shell)	DELL-FL34010C5A021	DELL-FL44010C5A021	DELL-FL54010C5A021	DELL-FLC4010C5A021
Westnet Code	00173303	00172302	00172301	00172300
Rated Voltage	230 VAC	230 VAC	230 VAC	230 VAC
Frequency	50 Hz	50 Hz	50 Hz	50 Hz
Rated Wattage	10 W	10 W	10 W	10 W
Deviation Tolerance of Wattage	±10 %	±10 %	±10 %	±10 %
Displacement factor (cos φ1)*	0.9(typical)	0.9(typical)	0.9(typical)	0.9(typical)
Rated Current	0.042A	0.042A	0.042A	0.042A
Maximum Input Current	0.048A	0.048A	0.048A	0.048A
Start On	<0.5S	<0.5S	<0.5S	<0.5S
Warm up time	<1S	<1S	<1S	<1S
Dimmable	NO	NO	NO	NO
Beam Angle	120°	120°	120°	120°

Peak luminous intensity (cd)	340	340	340	340
R9 CRI	>1	>1	>1	>1
Survival factor	90%	90%	90%	90%
Safety requirements	CE	CE	CE	CE
Lumen Maintenance factor	96%	96%	96%	96%
Stroboscopic effect metric (SVM)**	No Claimed	No Claimed	No Claimed	No Claimed
Flicker metric (PstLM)**	No Claimed	No Claimed	No Claimed	No Claimed
Energy Efficiency Class(EEC)	F	F	F	F
Applicable Environments	IP65	IP65	IP65	IP65
Exchangeable LED Module	NO	NO	NO	NO
Photobiological Group	RG 0	RG 0	RG 0	RG 0
Safety class	Class I	Class I	Class I	Class I

* Displacement factor tolerance +/- 10%

**In accordance with (EU)2019/2020 of SVM $\leq 0,4$ at full-load (except for HID with $\Phi_{use} > 4$ klm and for light sources intended for use in outdoor applications, industrial applications or other applications where lighting standards allow a CRI < 80)

B. Light Data

Color	Warm White	Natural White	Daylight	Cool White
Color Temperature (CCT)	3000K	4000K	5000K	6500K
Useful luminous flux*	740 lm			
Total luminous flux*	900 lm			
Color Rendering Index*	80			
Efficacy (Useful)*	74 lm/W	74 lm/W	74 lm/W	74 lm/W
Efficacy (Total)*	90 lm/W	90 lm/W	90 lm/W	90 lm/W
Color Consistency**	6 Step MacAdam Ellipse (6 SDCM)			

* tolerance +/- 10%

** 3000K center point (0.43387, 0.40319) ; 4000K center point (0.38177, 0.37959) ; 5000K center point (0.34464, 0.35506) ; 6500K center point (0.31230, 0.32825)

C. Lifetime

(Supplied Voltage: AC 230V ; Ambient Temperature: 25°C)

Lumen Maintenance Factor	70% of the rated lifetime
Rated Lifetime – L₇₀B₅₀	15,000 hrs
Switch cycles	≥ 15,000

D. Temperature Operation

Normal operation temperature	-20°C ~ 40°C
Relative Humidity	10% ~ 90%

E. Geometric Data

Model	LED Flood Light 10W
Maximum overall length	93 ± 2 mm (3.66 ± 0.08 inch)
Maximum overall width	91.4 ± 2 mm (3.60 ± 0.08 inch)
Maximum overall thickness	19.3 ± 2 mm (0.76 ± 0.08 inch)
Mass	135 g± 30g

F. Environmental relevant materials

Mercury (Hg)	Comply with RoHS Directive 2011/65/EU
Lead (Pb)	
Cadmium(Cd)	
Hexavalent Chromium(Cr6+)	
Polybrominated Biphenyls(PBBs)	
Polybrominated Diphenyl Ethers(PBDEs)	
Bis (2-ethylhexyl) phthalate(DEHP)	
Butyl benzyl phthalate(BBP)	
Dibutyl phthalate(DBP)	
Diisobutyl phthalate(DIBP)	

2. Outline Drawing

Unit : mm

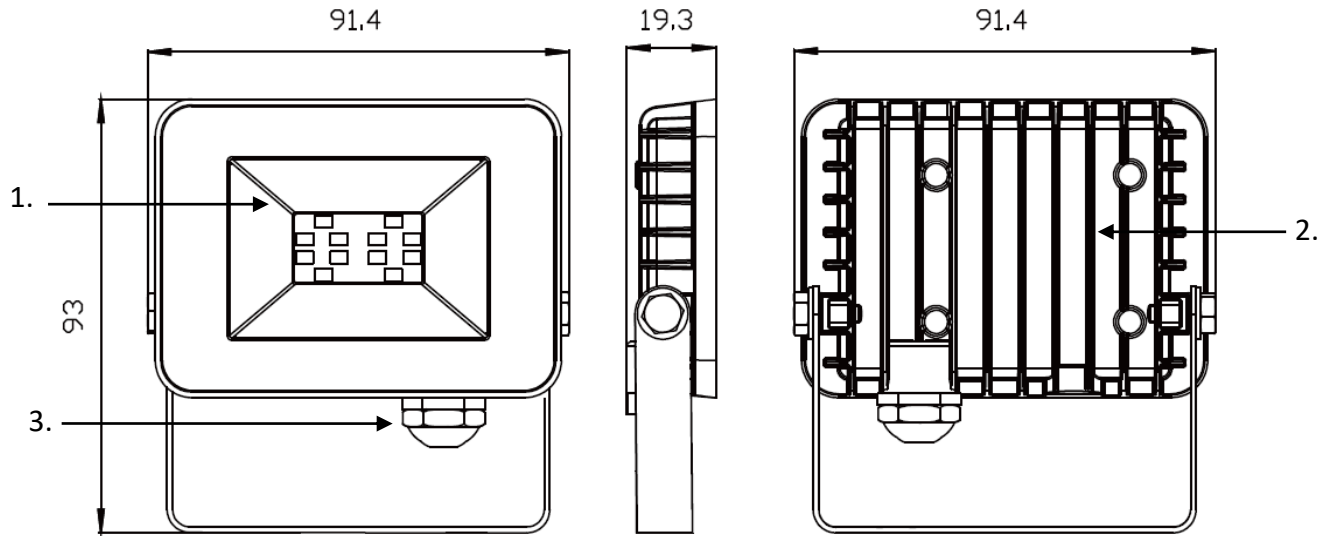

Material Information

- 1. Cover: Glass
- 2. Body: Metal
- 3. Gland: Metal

3. Light Distribution Curve

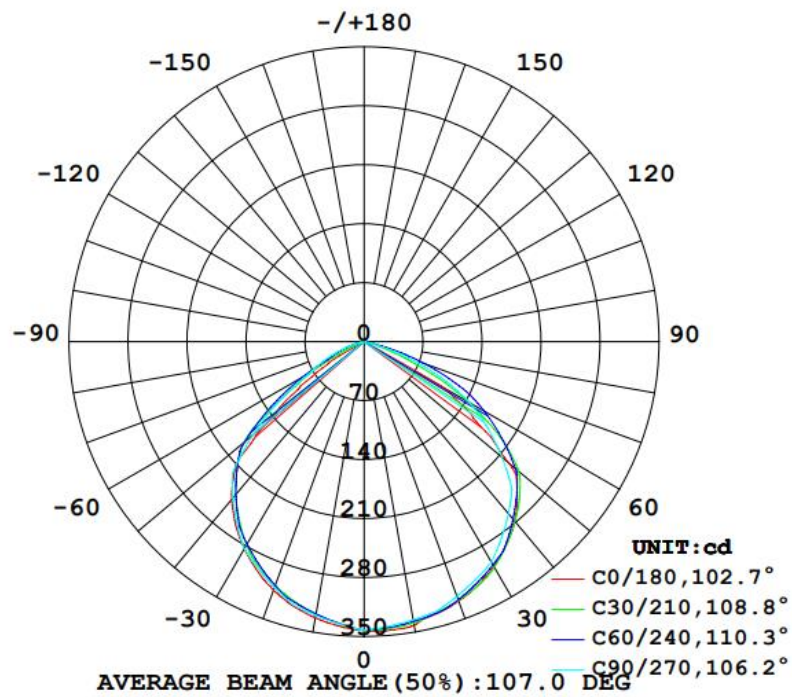

4. Spectrum Distribution

● 3000K Color Temperature

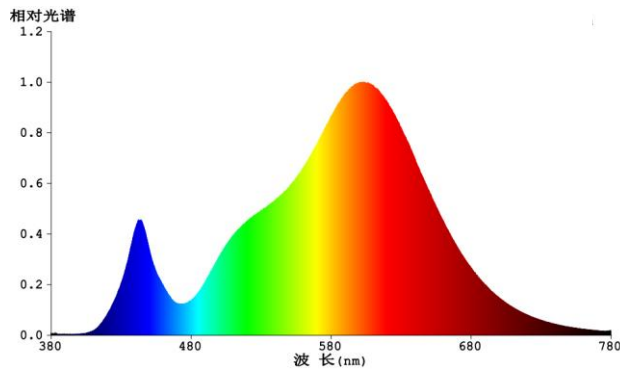

● 4000K Color Temperature

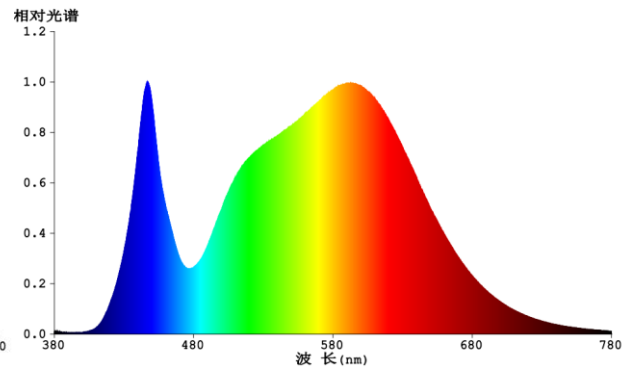

● 5000K Color Temperature

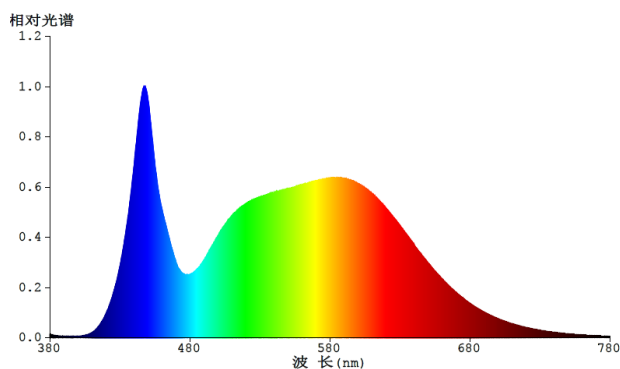

● 6500K Color Temperature

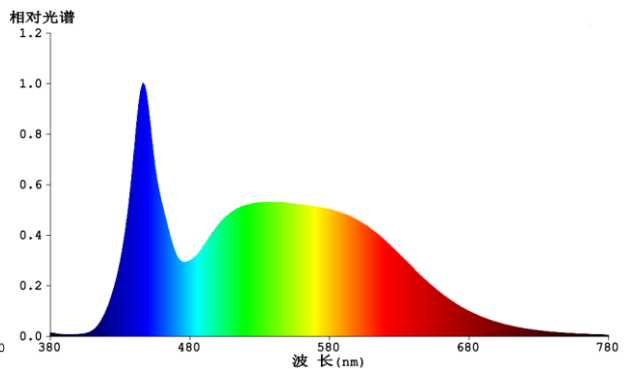

5. Warnings

- Before replacing, turn off power and let high bay cool to avoid electrical shock or burn.
- Do not touch electronic components, electronic components maybe under high voltage.
- Do not stare into LED light beam
- The luminaire shall be installed by a qualified electrician and wired in accordance with the latest IEE electrical regulations or the national requirements.

6. Cautions

Only to apply in dry and most of open fixtures with lamp-holders that offer sufficient space (10 mm free air space). Not intended for use with emergency light fixtures for exit lights.

7. Notes

All characteristics are estimated at room temperature (25°C), free air burning, base up burning position and at rated voltage. In view of the complex manufacturing process for light above for the technical LED parameters are merely statistical values that do not necessarily correspond to the actual technic individual products may vary from the typical values.

8. Logistic information

Model	LED Flood Light 10W 3000K	LED Flood Light 10W 4000K	LED Flood Light 10W 5000K	LED Flood Light 10W 6500K
Pieces per pack	1	1	1	1
EAN code on pack -Black shell	4711112386109	4711112383986	4711112385485	4711112386093
EAN code on pack -White shell	4711112388578	4711112388561	4711112388554	4711112388547
Size of pack	98x30x104mm	98x30x104mm	98x30x104mm	98x30x104mm
Weight per pack (G.W)	0.155 kg	0.155 kg	0.155 kg	0.155 kg
Packs per inner box	N/A	N/A	N/A	N/A
EAN code on inner box	N/A	N/A	N/A	N/A
ITF code on inner box	N/A	N/A	N/A	N/A
Size of inner box	N/A	N/A	N/A	N/A
Weight per inner box(G.W)	N/A	N/A	N/A	N/A
Packs per outer box	50	50	50	50
EAN code on outer box	N/A	N/A	N/A	N/A
ITF code on outer box -Black shell	14711112386106	14711112383983	14711112385482	14711112386090
ITF code on outer box -White shell	14711112388575	14711112388568	14711112388551	14711112388544
Size of outer box	510x170x228mm	510x170x228mm	510x170x228mm	510x170x228mm
Weight per outer box(G.W)	8.2Kg	8.2Kg	8.2Kg	8.2Kg

Package box

3000K



4000K



5000K



6500K



9. ERP Label

DELL-FL34010C5A011 / DELL-FL44010C5A011 / DELL-FL54010C5A011 / DELL-FLC4010C5A011

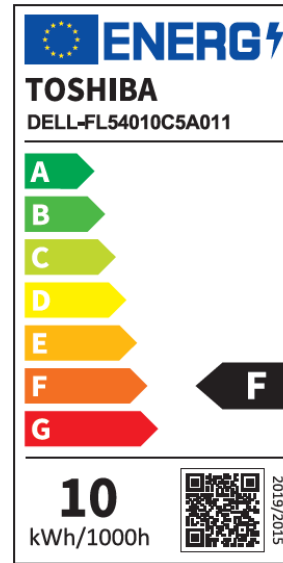
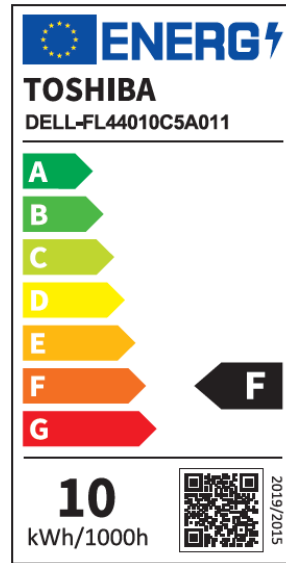
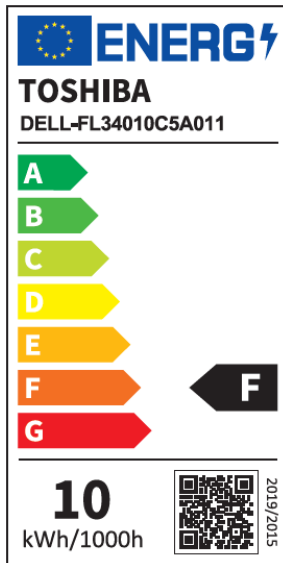

DELL-FL34010C5A021 / DELL-FL44010C5A021 / DELL-FL54010C5A021 / DELL-FLC4010C5A021

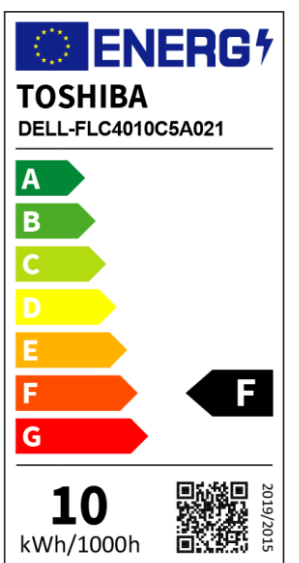
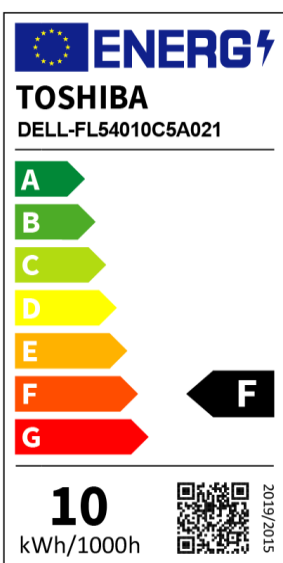
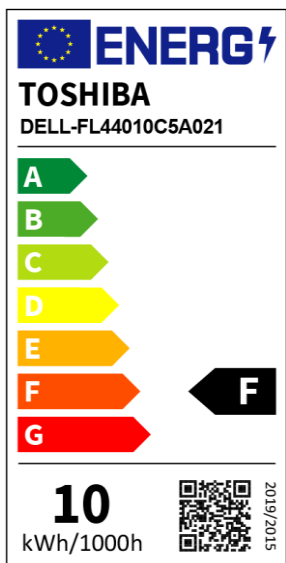
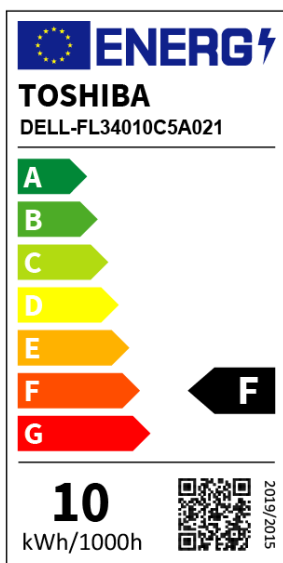

10. Conformity

2014/35/EU; Low Voltage Directive	EN 60598-2-5: 2015 ; EN IEC 60598-1: 2021 ; IEC/TR 62778:2014 ; EN 62493:2015 ; EN IEC 62031:2020
2014/30/EU; EMC Directive	EN IEC 55015: 2019+A11:2020 、 EN IEC 61000-3-2:2019+A1:2021 、 EN 61000-3-3: 2013+A2:2021 、 EN 61547: 2009
2009/125/EC; ErP Directive	(EU) 2019/2015 、 (EU) 2019/2020 、 (EU) 2021/340 、 (EU) 2021/341
2011/65/EU+(EU)2015/863; RoHS Directive	EN 50581: 2012