



N-Channel Enhancement Mode MOSFET

Features

- ◆ $V_{DSS} = 100V$
- ◆ $R_{DS(ON)} < 2.1\ m\Omega @ V_{GS} = 10\ V$
- ◆ Fully Avalanche Rated
- ◆ Pb Free & RoHS Compliant
- ◆ Isolation Type Package
- ◆ Electrically Isolation base plate

Preliminary

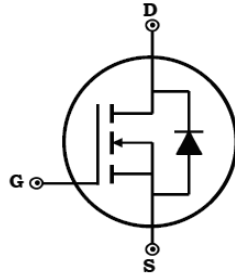

SOT-227

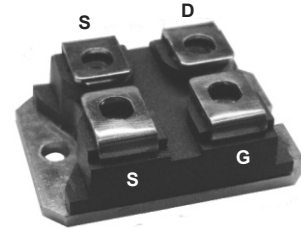

Dimensions in inches and (millimeters)

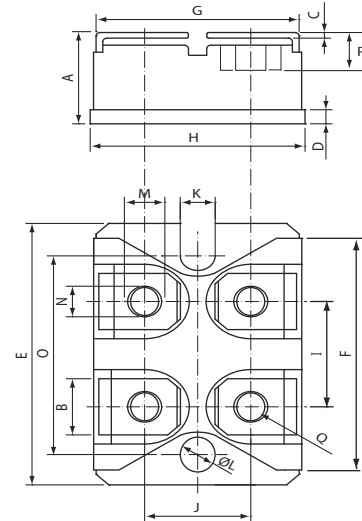

Applications

- ◆ Backlighting
- ◆ Power Converters
- ◆ Synchronous Rectifiers

Absolute Maximum Ratings (Tc=25°C unless otherwise noted)

Parameter	Symbol	Ratings	Unit
Drain-Source Voltage	V_{DS}	100	V
Gate-Source Voltage	V_{GS}	±20	V
Drain Current-Continuous @ $T_c = 25^\circ C$ @ $T_c = 100^\circ C$	I_D	320 280	A
Drain Current-Pulsed @ $T_c = 25^\circ C$ ^{Note1}	I_{DM}	900	A
Maximum Power Dissipation	P_D	424	W
Storage Temperature Range	T_{STG}	-50 to +150	°C
Operating Junction Temperature Range	T_J	-50 to +150	°C
Thermal Resistance, Junction-to-Case	$R_{\theta JC}$	0.20	°C/W
Isolation Voltage (A.C. 1 minute)	V_{iso}	2500	V
Mounting torque (M4 Screw)	M_d	1.3	N·m

DIM	DIMENSIONS			
	INCHES		MM	
	MIN	MXA	MIN	MXA
A	.500	.519	12.70	13.60
B	.307	.322	7.80	8.20
C	.029	.033	.75	.84
D	.073	.082	1.85	2.10
E	1.487	1.502	37.80	38.20
F	1.250	1.258	31.75	32.00
G	.931	.956	23.65	24.30
H	.996	1.007	25.30	25.60
I	.586	.594	14.90	15.10
J	.492	.516	12.50	13.10
K	.161	.169	4.10	4.30
L	.161	.169	4.10	4.30
M	.181	.191	4.60	4.95
N	.165	.177	4.20	4.50
O	1.184	1.192	30.10	30.30
P	.217	.244	5.50	6.20
Q	M4*8			



Electrical Characteristics @ T_J =25°C (unless otherwise specified)

Parameter	Symbol	Conditions	Min.	Typ.	Max.	Unit
OFF Characteristics						
Drain-Source Breakdown Voltage	BV _{DSS}	V _{GS} =0V , I _{DS} =3mA	100	-	-	V
Zero Gate Voltage Drain Current	I _{DSS}	V _{GS} =0V , V _{DS} =100V	-	-	50	uA
Gate-Body Leakage	I _{GSS}	V _{GS} =±20V , V _{DS} =0V	-	-	200	nA
ON Characteristics						
Gate Threshold Voltage	V _{TH}	V _{DS} =V _{GS} , I _{DS} =8mA	2.5	-	3.5	V
Drain-Source On-State Resistance	R _{DS(on)}	V _{GS} =10V , I _{DS} =100A	-	1.9	2.1	mΩ
Gate Resistance	R _G		-	1.9	2.9	Ω
Forward Transconductance	g _{fs}	V _{DS} >2 I _D R _{DS(on)M} , I _D =100A ^{Note1}	-	121	-	S
Dynamic Characteristics						
Input Capacitance	C _{iss}	V _{DS} =25V	-	31260	-	pF
Output Capacitance	C _{OSS}	V _{GS} =0V	-	1424	-	
Reverse Transfer Capacitance	C _{rss}	Freq.=1MHz	-	1007	-	
Switching Characteristics						
Turn-On Delay Time	t _{d(on)}	V _{DS} =50V V _{GS} =10V I _{DS} =160A	-	100	-	ns
Rise Time	t _r		-	48	-	
Turn-Off Delay Time	t _{d(off)}		-	180	-	
Fall Time	t _f		-	56	-	
Total Gate Charge at 10V	Q _g	V _{DS} =50V	-	321	-	nC
Gate to Source Charge	Q _{gs}	V _{GS} =10V	-	158	-	
Gate to Drain Charge	Q _{gd}	I _{DS} =160A	-	131	-	
Reverse Diode Characteristics						
Drain-Source Diode Forward Voltage	V _F	T _J =25°C , I _F =100A	-	-	0.9	V
Diode Continuous Forward Current	I _F		-	-	280	A
Diode Pulsed Current ^{Note1}	I _{F,pulse}		-	-	900	A
Reverse Recovery time	T _{RR}	I _F =0.5V , I _R =1.0A , I _{RR} =0.25A	-	-	210	ns

Notes:

1. Pulse Test: Pulse Width ≤ 300 μs, Duty Cycle > 2%.



Typical Characteristics

Fig 1. Power dissipation

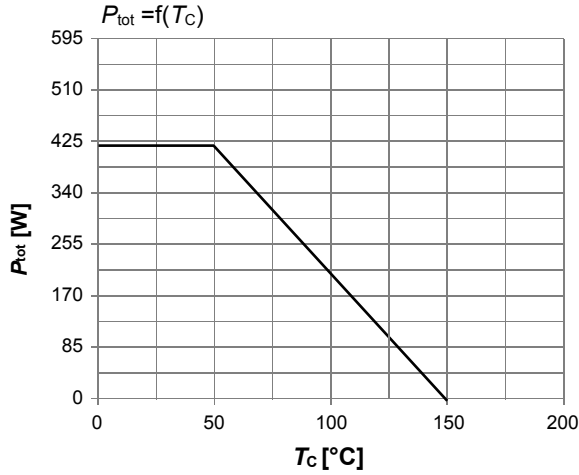

Fig 2. Drain current

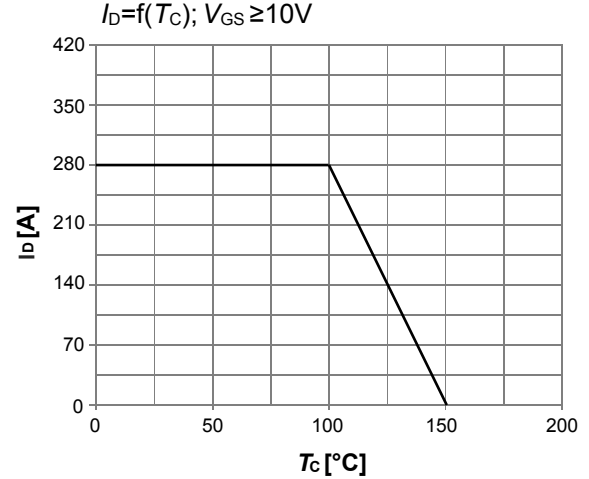

Fig 3. Safe operating area

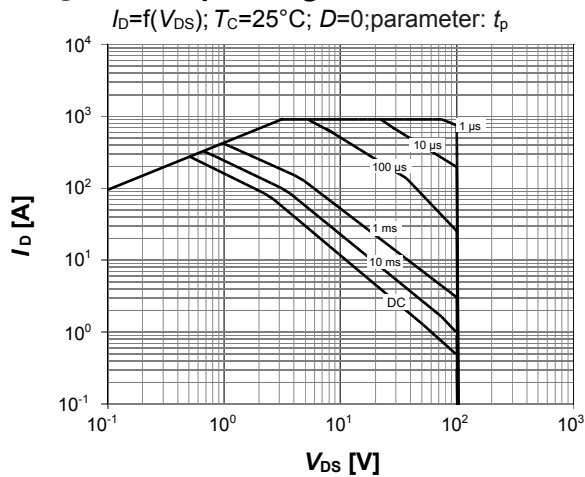

Fig 4. Maximum Transient Thermal Impedance

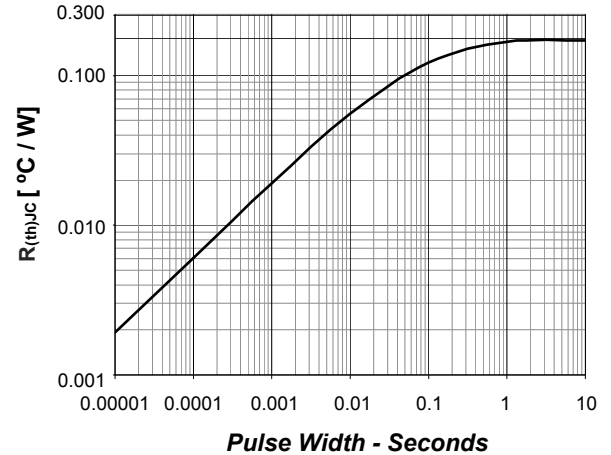

Fig 5. Typ. output characteristics

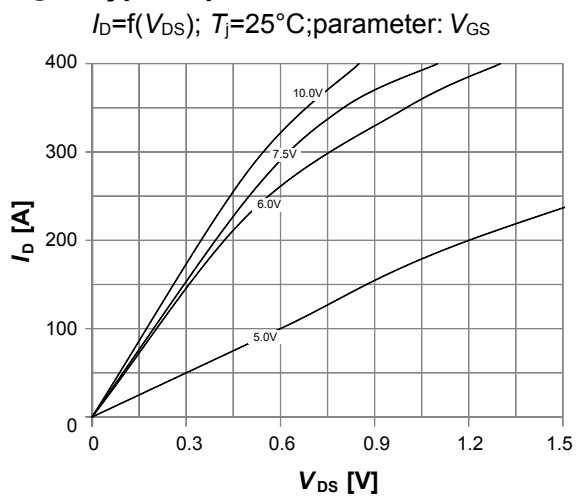
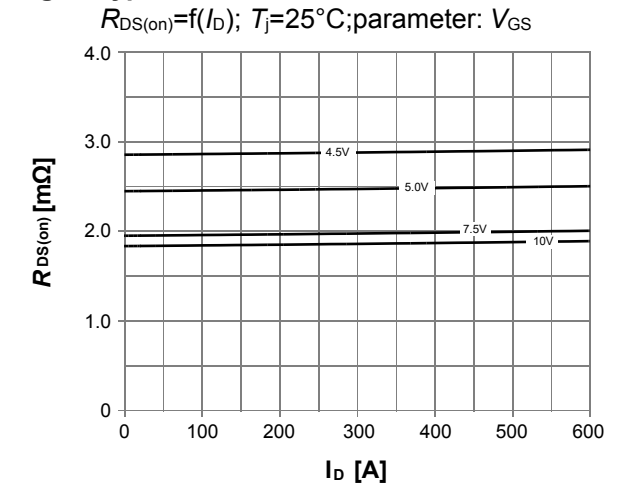

Fig 6. Typ. drain-source on resistance





Typical Characteristics

Fig 7. Typ. transfer characteristics

$I_D = f(V_{GS}); |V_{DS}| > 2|I_D|R_{DS(on)max}; \text{parameter: } T_j$

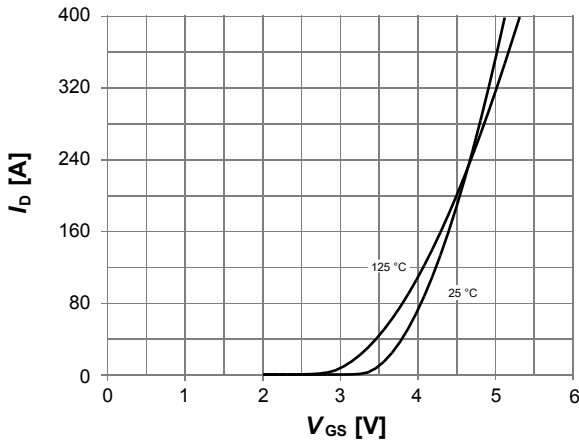

Fig 8. Typ. forward transconductance

$g_{fs} = f(I_D); T_j = 25^\circ\text{C}$

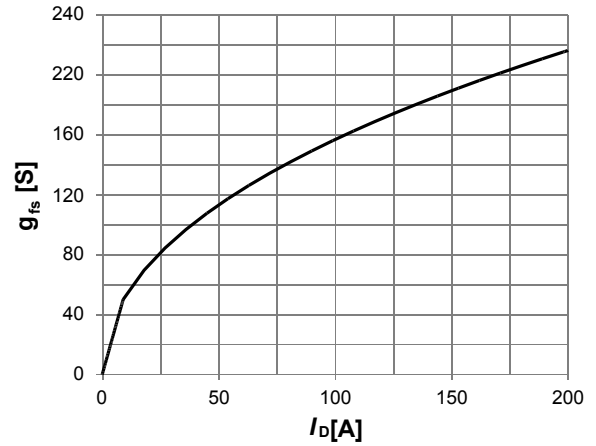

Fig 9. Drain-source on-state resistance

$R_{DS(on)} = f(T_j); I_D = 150\text{A}; V_{GS} = 10\text{V}$

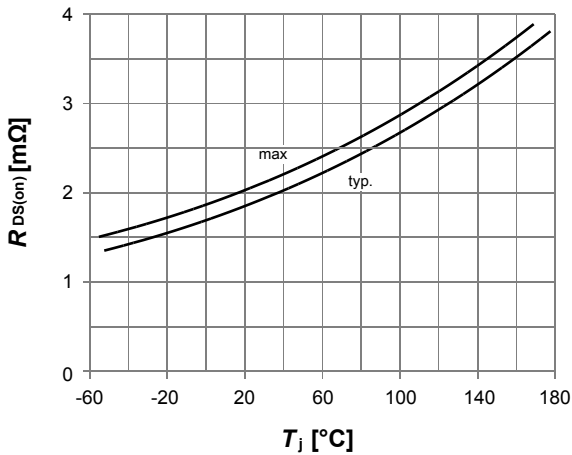

Fig 10. Typ. gate threshold voltage

$V_{GS(th)} = f(T_j); V_{GS} = V_{DS}; \text{parameter: } I_D$

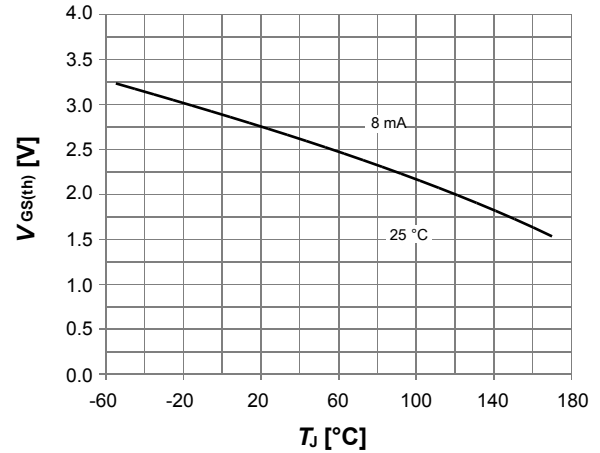

Fig 11. Typ. capacitances

$C = f(V_{DS}); V_{GS} = 0\text{V}; f = 1\text{MHz}$

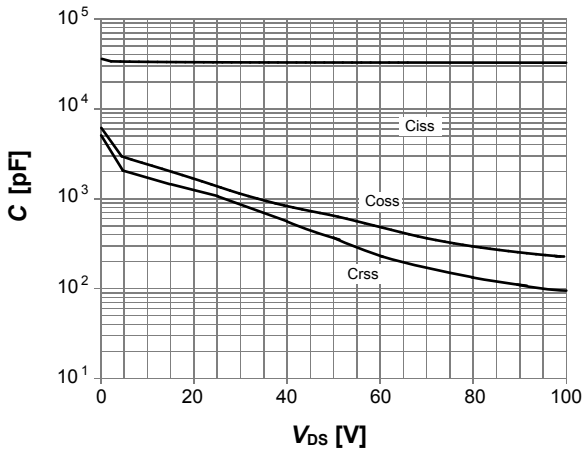
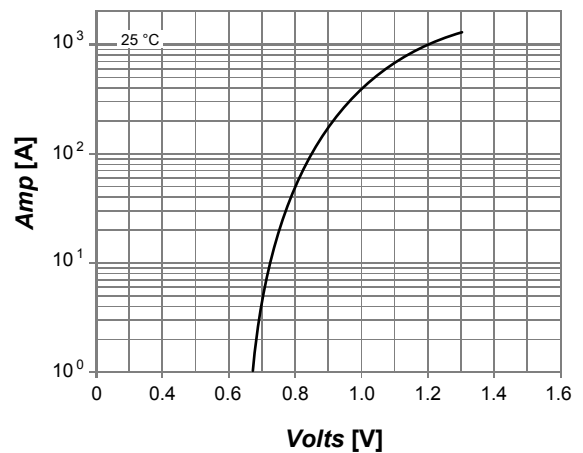

Fig 12. Typical forward characteristics of reverse diode





Typical Characteristics

Fig 13. Forward derating curve of reverse diode

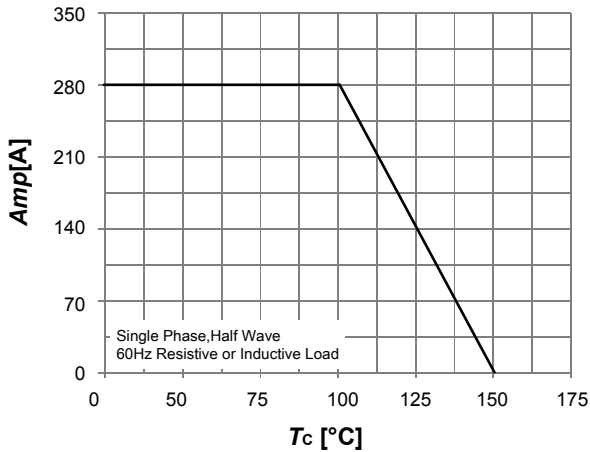

Fig 14. Peak forward surge current of reverse diode

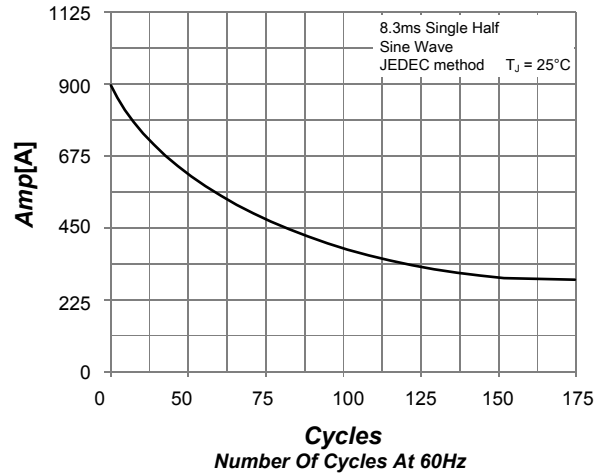

Fig 15. Typical reverse diode characteristics

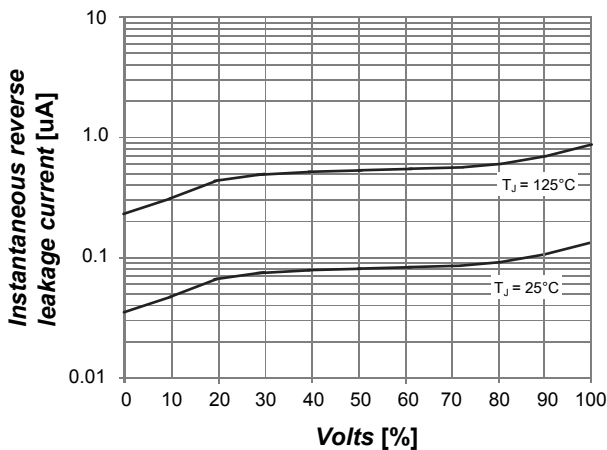

Fig 16. Typ. gate charge

$V_{GS} = f(Q_{gate})$; $I_D = 100\text{A}$ pulsed; parameter: V_{DD}

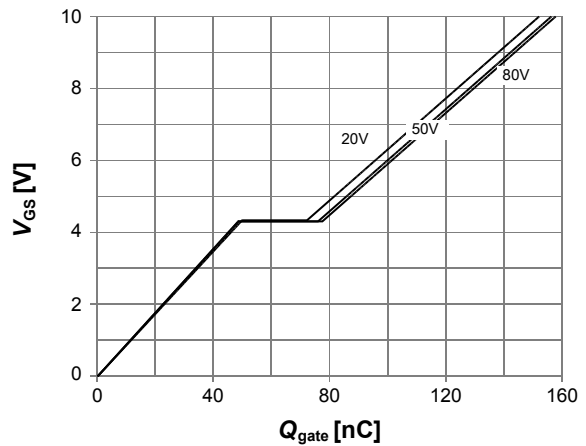

Fig 17. Gate charge waveforms

