

2 x 4" 250W AC-DC Power Supplies

<https://product.tdk.com/en/power/cus-m>
www.emea.lambda.tdk.com/cus250m

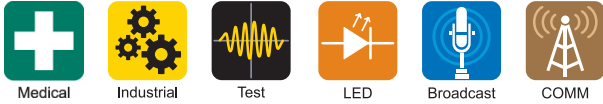
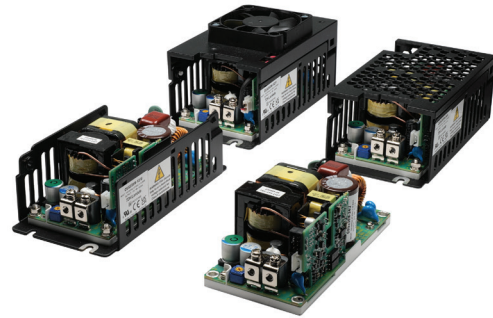

The compact CUS250M is packaged in the industry standard 2x4" footprint. The series can deliver 250W with forced air or conduction cooling in ambient temperatures of up to 50°C. With Medical & ITE certifications, the unit can be used in both Class I & Class II (no ground wire) applications, and meets Class B Conducted and Radiated EMI with generous margins. Options include a 5V standby voltage, remote on/off, DC_OK and AC_Fail signals, with a U channel, cover or top fan mechanical construction.

Features	Benefits
• Up to 250W Utilizing Convection and Conduction Cooling	• Quiet Operation
• Operation in Ambient Temperatures of up to 85°C	• Suitable for High Ambient Temperature Environments
• Medical Certifications (2 x MOPP)	• Suitable for B and BF Type Medical Equipment
• Class B Conducted and Radiated EMI with Significant Margins	• Easier System EMC Compliance
• Suitable for Class I and Class II installations	• Flexible Utilisation
• Compact 2 x 4 x 1.56" / 50.8 x 101.6 x 39.5mm Size	• Space Saving in End Equipment
• Enclosure & Cooling Options	• Versatile Application

Model Selector					
Model	Nominal Output Voltage (V)	Output Adjustment ⁽¹⁾ (V)	Fan Supply (V)	Maximum Current Forced Air (A)	Maximum Power Forced Air (W)
CUS250M-12	12	12 - 13.2	11.4	20.83	250
CUS250M-15	15	15 - 16.5	11.4	16.66	250
CUS250M-18	18	18 - 19.8	11.4	13.88	250
CUS250M-24	24	24 - 26.4	11.4	10.41	250
CUS250M-28	28	28 - 30.8	11.4	8.92	250
CUS250M-36	36	36 - 39.6	11.4	6.94	250
CUS250M-48	48	48 - 50.0	11.4	5.2	250

Contact Factory for availability - expected Q2 2023

CUS250M-	12	/	U	M	-	J
	Output voltage 12, 15, 18, 24, 28, 36, 48			blank JST connectors M ⁽²⁾ Molex type input connectors		
			blank Open frame (with integral baseplate) U U channel A U channel with cover F U channel, cover and top mounted fan C M3 inserts for underside mounting		blank Dual fuses E ⁽²⁾ Single input fuse in line	
						blank No options G 5V 0.1A standby supply, remote on/off (enable), DC_OK, AC_Fail J 5V 0.1A standby supply, remote on/off (inhibit), DC_OK, AC_Fail

Notes:
 See website for detailed specifications, test methods and installation manual.
 Specification parameters apply at 25°C ambient temperature unless otherwise stated.
 (1) Output voltage is user adjustable or can be factory set.
 Non-standard output versions may be subject to minimum order quantities and variations to specification.
 For all non-standard output voltage settings please consult Sales.
 (2) Subject to Minimum Order Quantities. Please contact Sales

Specifications		
Model		CUS250M
Input		
Input Voltage range	Vac	85 - 264 ⁽³⁾
Input Frequency	Hz	47 - 63 ⁽⁴⁾
Input Current (100Vac)	A	3.2
Inrush Current at 230Vac (Cold Start)	A	<75. Note: the inrush I2t is significantly below the breaking capacity of the internal 5A fast acting fuse, or an external circuit breaker
Leakage Current	uA	<150 at 264Vac 63Hz
Touch Current (Enclosure Leakage)	uA	Class I: <10, Class II: <70, at 264Vac 63Hz
Power Factor (115/230Vac)	-	>0.9 / >0.7 (>20% load)
Harmonic Compliance	-	Meets IEC61000-3-2 Class A
No Load Power Consumption	W	<0.5 (230Vac) when output is inhibited
Hold Up Time	ms	>14
Efficiency	%	Up to 94
Average Efficiency	%	>91 Measured at 25%, 50%, 75% and 100% load conditions
Conducted & Radiated EMI	-	EN55032 / EN55011-B (See application notes for conditions)
Immunity	-	Compliant with EN60601-1-2:2015 (Edition 4), see immunity table
Insulation Class	-	Construction suitable for Class I or Class II installation
Safety Certifications and Markings	-	IEC/EN/60601-1. ES60601-1. IEC/EN/UL62368-1, 60950-1, 61010-1 (designed to meet), CE Mark and UKCA Mark

Notes:

(3) Derate output power linearly to 225W load from 100 to 90Vac input and to 200W from 90 to 85Vac input

(4) For operation at 440Hz please consult Technical Sales.

Immunity			
Test	Test	UOM	Level & Criteria
IEC61000-4-2 (ESD)	Enclosure Port	Lvl	Level 4, Criteria A
	AC Port	Lvl	Level 4, Criteria A
	CH1 and Standby	Lvl	Level 3, Criteria A
	Signal I/O Port (Remote On/Off, AC_FAIL, DC_OK)	Lvl	Level 3, Criteria A
IEC61000-4-3 (Radiated Immunity)	80 MHz to 2.7 GHz	V/m	10 (Level 3, Criteria A)
	2.7 GHz to 6 GHz	V/m	10 (Level 3, Criteria A)
EN 60601-1-2:2015 (Radiated Immunity)	Immunity to RF Wireless Communications Equipment (Table 9)	-	All Criteria, Criteria A
CISPR 35	1.8 GHz to 5 GHz	V/m	3 (Table 1, condition 1.3 requirements, Criteria A)
IEC 61204-3: 2000	900 MHz (Keyed Carrier)	V/m	3 (Criteria A)
IEC61000-4-4	AC Port	kV	4 (Level 4, Criteria A)
(Electrical Fast Transient Burst)	CH1	kV	-
	Fan Out, Standby	kV	N/A
	Signal I/O Port (Remote On/Off, AC_FAIL, DC_OK)	kV	2 (Level 4, Criteria A)
	(AC input common mode)	kV	2 (Level 3, Criteria A)
IEC61000-4-5 (Surge)	(AC input normal mode)	kV	1 (Level 3, Criteria A)
	(AC input common mode)	V	10 (Level 3, Criteria A)
IEC61000-4-6 (Conducted Susceptibility)	(DC output common mode)	V	10 (Level 3, Criteria A)
	(Fan Out, Standby common mode)	V	N/A
	(Signal I/O common mode)	V	N/A
IEC61000-4-8 (Power Frequency Mag. Field)		A/m	(Level 4, Criteria A)
IEC61000-4-11 (Voltage dips / Interruption)	When exited factory (Bulk cap life degradation not considered)	-	Class 3
	0% for 0.5 cycle	Criteria	A
	0% for 1 cycle	Criteria	A ≤175W, B >175W
	40% for 10/12 cycles	Criteria	100Vac: A ≤50W, B >50W; 220Vac: A
	70% for 25/30 cycles	Criteria	100Vac: A ≤150W, B >150W; 220Vac: A
IEC60601-1-2 (Voltage dips / Interruption)	80% for 250/300 cycles	Criteria	100Vac: A ≤200W, B >200W; 220Vac: A
	0% for 250/300 cycles	Criteria	B
	When exited factory (Bulk cap life degradation not considered)	-	-
	0% for 0.5 cycle	Criteria	A
	0% for 1 cycle	Criteria	A ≤175W, B >175W
IEC61000-6-2 (Voltage dips / Interruption)	70% for 25/30 cycles	Criteria	100Vac: A ≤150W, B >150W; 220Vac: A
	0% for 250/300 cycles	Criteria	B
	0% for 1 cycle	Criteria	B
	40% for 10/12 cycles	Criteria	C
	70% for 25/30 cycles	Criteria	C
IEC61204-3 (Voltage dips / Interruption)	0% for 250/300 cycles	Criteria	C
	30% for 10 ms	Criteria	B
	60% for 100 ms	Criteria	100Vac: A ≤70W, B >70W; 220Vac: A
SEMI F47	95% for 5000 ms	Criteria	C
	50% for 0.2 s	Criteria	170Vac: A ≤240W, B >240W; 220Vac: A
	70% for 0.5 s	Criteria	A
	80% for 1s	Criteria	A
IEC61000-4-12 (Ringwave Test)		-	(Level 3, Criteria A)
EN61000-4-14 (Voltage Fluctuations)		-	Class 3, Criteria A

Specifications		
Model		CUS250M
Output		
Line Regulation	%	<0.5 (85 - 264Vac)
Load Regulation	%	<1 (0 - 100% load)
External Load Capacitance	uF	12V: 20,830, 15V: 16,660, 24V: 2,290, 28V: TBD, 36V: TBD, 48V: TBD
Ripple & Noise	%	<1 of nominal output for operating temperatures above 0°C 12V model: <2, other voltages: <1.5 at -20°C. <2 in burst mode when the load is <10% of the rated current External load capacitance will reduce the amplitude.
Temperature Coefficient	%/°C	±0.02
Minimum Load	-	No minimum load required
Overcurrent Protection	%	110 to 170. Hiccup mode, automatic recovery
Overvoltage Protection	-	115-140% of standard output voltage for each model, 48V model max 60V. Latching (unit shutdown), cycle AC input or use remote on/off to reset
Overtemperature Protection	-	Latching, cycle AC or use remote on/off to reset
Remote Sense	-	None
Remote On/Off (TBD)	-	Opto-isolated. Inhibit: High = OFF, Low = ON, Enable: High = ON, Low = OFF
Standby Voltage		5V 0.1A
Fan Supply	-	11.4V 0.5A
Parallel Operation	-	Not possible
Series Operation	-	Please contact Technical Sales for guidance
Environmental		
Operating Temperature (-40°C start-up)	°C	-20 to +85 with system forced air cooling (70 maximum for fan version /F), see derating curves below
Storage Temperature	°C	-40 to +85 (70 maximum for fan version /F)
Operating Humidity (non condensing)	%RH	5 - 95 (15 - 90 for /F fan version)
Pollution Degree	-	PD2 Material group IIIb
Cooling	-	Convection, conduction or forced air cooling. See derating curves below
Altitude	m	5,000
Withstand Voltage (For 1 minute)	Vac	Input to Ground 1,500 (1xMOPP), Input to Output 4,000 (2xMOPP), Output to Ground 1,500 (1xMOPP)
Isolation Resistance	MΩ	>100 at 25°C, 70%RH & 500VDC
Vibration (non operating)	-	2G, 10-500Hz for 1 hour
Shock (non operating)	-	30G, 11ms half sine
Other		
Weight	g	Open frame: 275, /A: 320, /C: 275, /F: 345, /U: 305
Size (WxLxH)	mm	Open frame : 50.8 x 101.6 x 39.5
		U channel : 64 x 119.2 x 39.5
		Cover (/A) : 64 x 119.2 x 43
		Fan (/F) : 64 x 119.2 x 60.6
Size (WxLxH)	Inches	Open frame: 2 x 4 x 1.56
		U channel : 2.52 x 4.69 x 1.56
		Cover (/A) : 2.52 x 4.69 x 1.69
		Fan (/F) : 2.52 x 4.69 x 2.39
Connectors	-	Input: JST B2P3-VH, Output: M3 screw, Fan: Molex 22-05-7025, Signals: Molex 87833-0833
Warranty	yrs	5

Peak Power Rating Curves

U chassis configuration, convection cooled on metal baseplate

50°C, 10% Duty Cycle

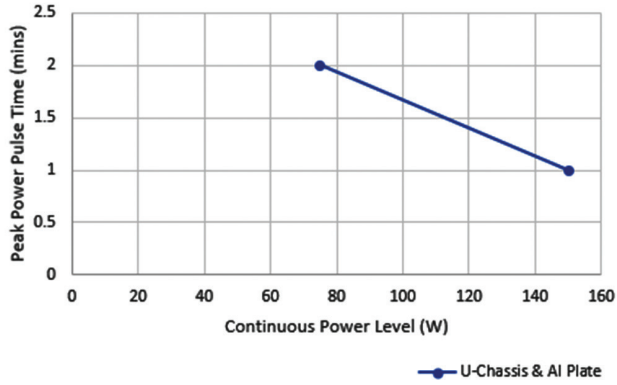

Examples:
 150W continuous - 250W peak - 1 min pulse time - 10% duty cycle
 75W continuous - 250W peak - 2 mins pulse time - 10% duty cycle

Peak Power Rating Curves

Open frame configuration, convection cooled (no metal baseplate)

25°C, 10% Duty Cycle

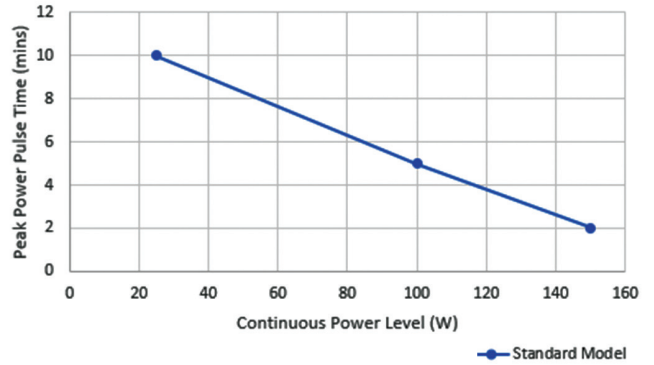

Examples:
 150W continuous - 250W peak - 2 mins pulse time - 10% duty cycle
 100W continuous - 250W peak - 5 mins pulse time - 10% duty cycle
 25W continuous - 250W peak - 10 mins pulse time - 10% duty cycle

Orientation

Horizontal Orientation A

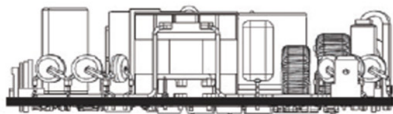

Vertical Orientation B



Notes:
 See website for detailed specifications, test methods and installation manual.
 Specification parameters apply at 25°C ambient temperature unless otherwise stated.

Output Power vs Ambient Temperature

Conduction/convection cooled CUS250M-12

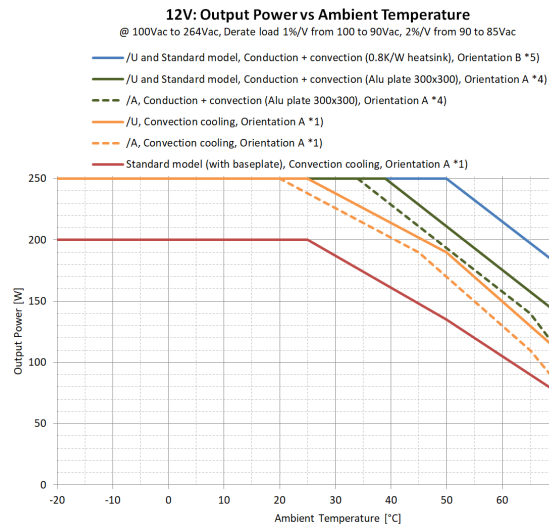

Output Power vs Ambient Temperature

Conduction/convection cooled CUS250M-24

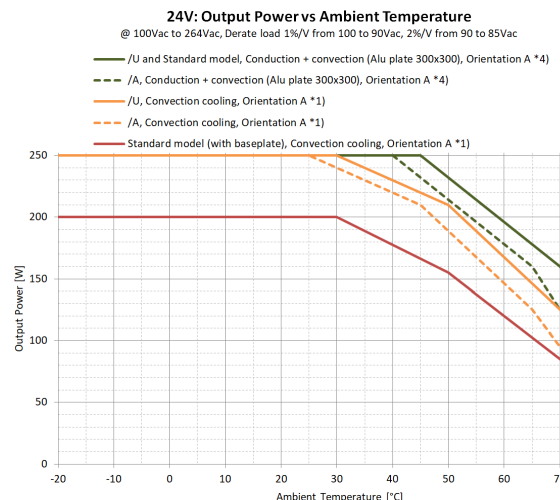

Output Power vs Ambient Temperature (forced air cooled) all CUS250M voltages

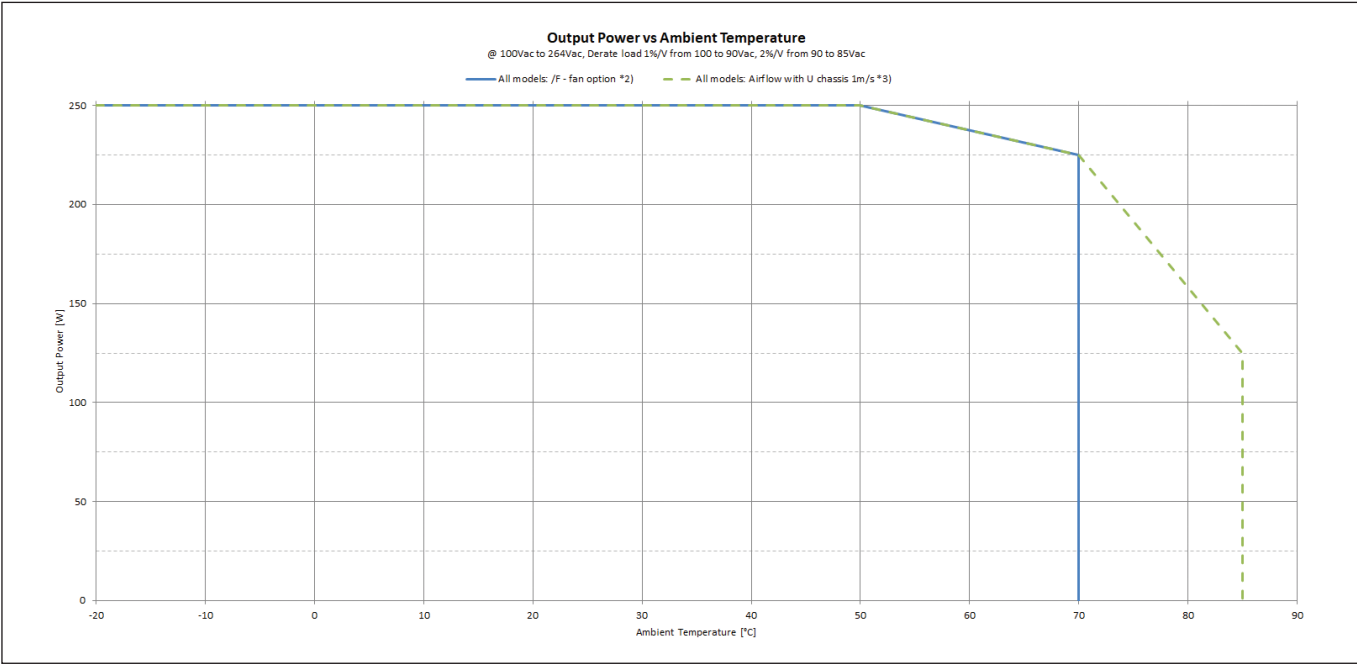

Standby and Fan Output Power vs Ambient Temperature

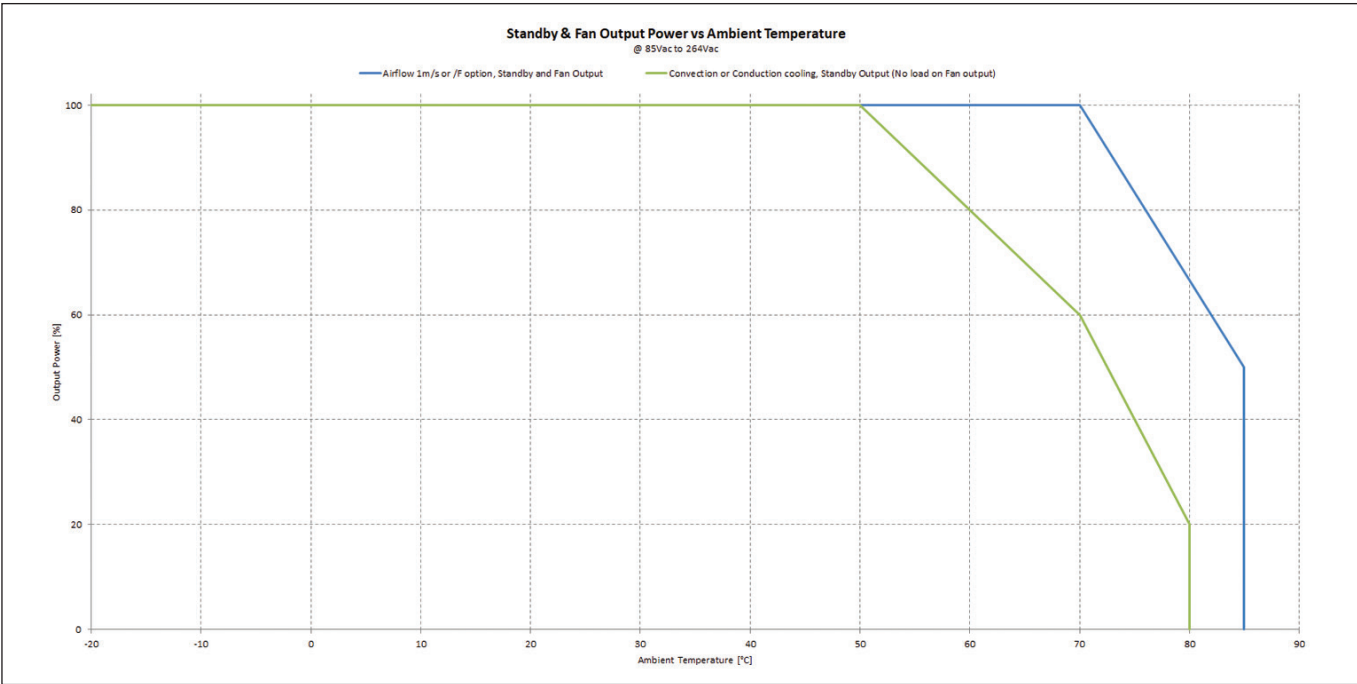

Notes

- 1: Orientation A (see Application Note), 50mm above surface.
Standby output is loaded (see derating curves for Standby output), no load on Fan output
- 2: 50mm above surface. Limited by fan specification to 70°C maximum
- 3: Tested with U chassis with airflow direction 1 (see Application Note).
Customer to ensure airflow rate and direction to keep components temperature below the limits.
Standby and Fan output load according to derating curves.
Measured in wind tunnel with 5mm space on side of U chassis.
- 4: Mounted on natural aluminium plate, 300x300x1mm lifted 50mm above other surfaces
Orientation A (see Application Note)
Standby output is loaded (see derating curves for Standby output), no load on Fan output

Outline Drawing CUS250M Open Frame Unit (Integral baseplate)

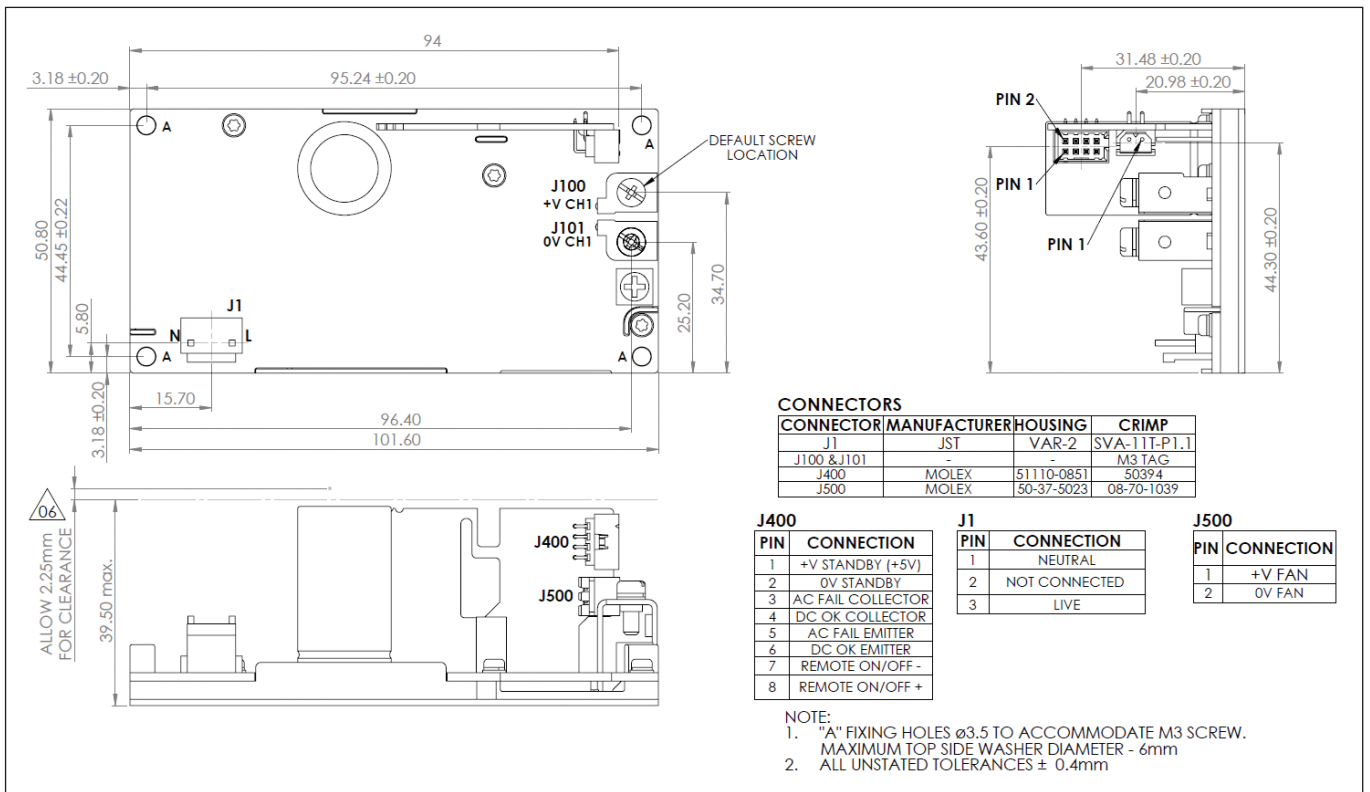

Outline Drawing CUS250M/C Open Frame Unit with inserts (Integral baseplate)

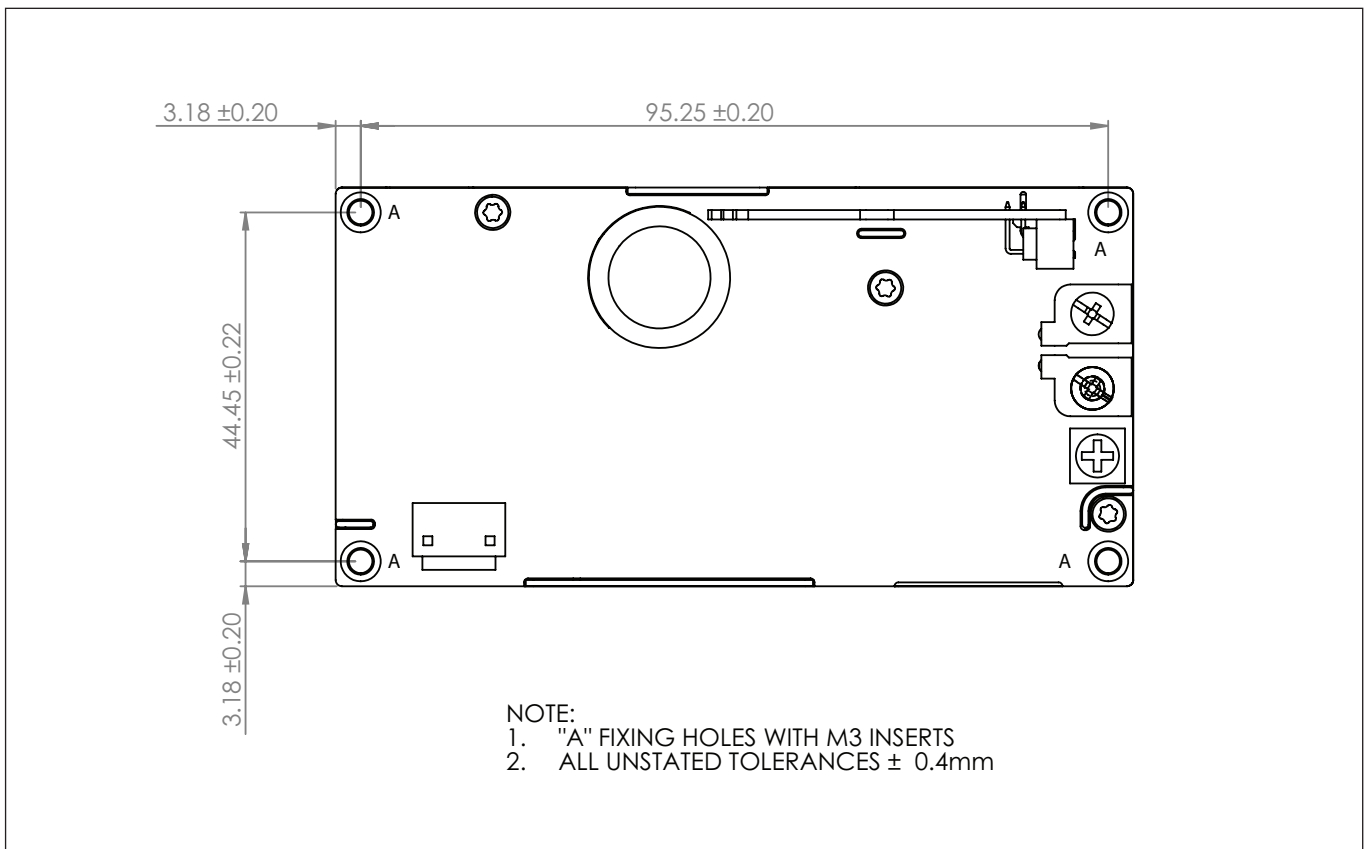

Outline Drawing CUS250M/U (U Channel) Option

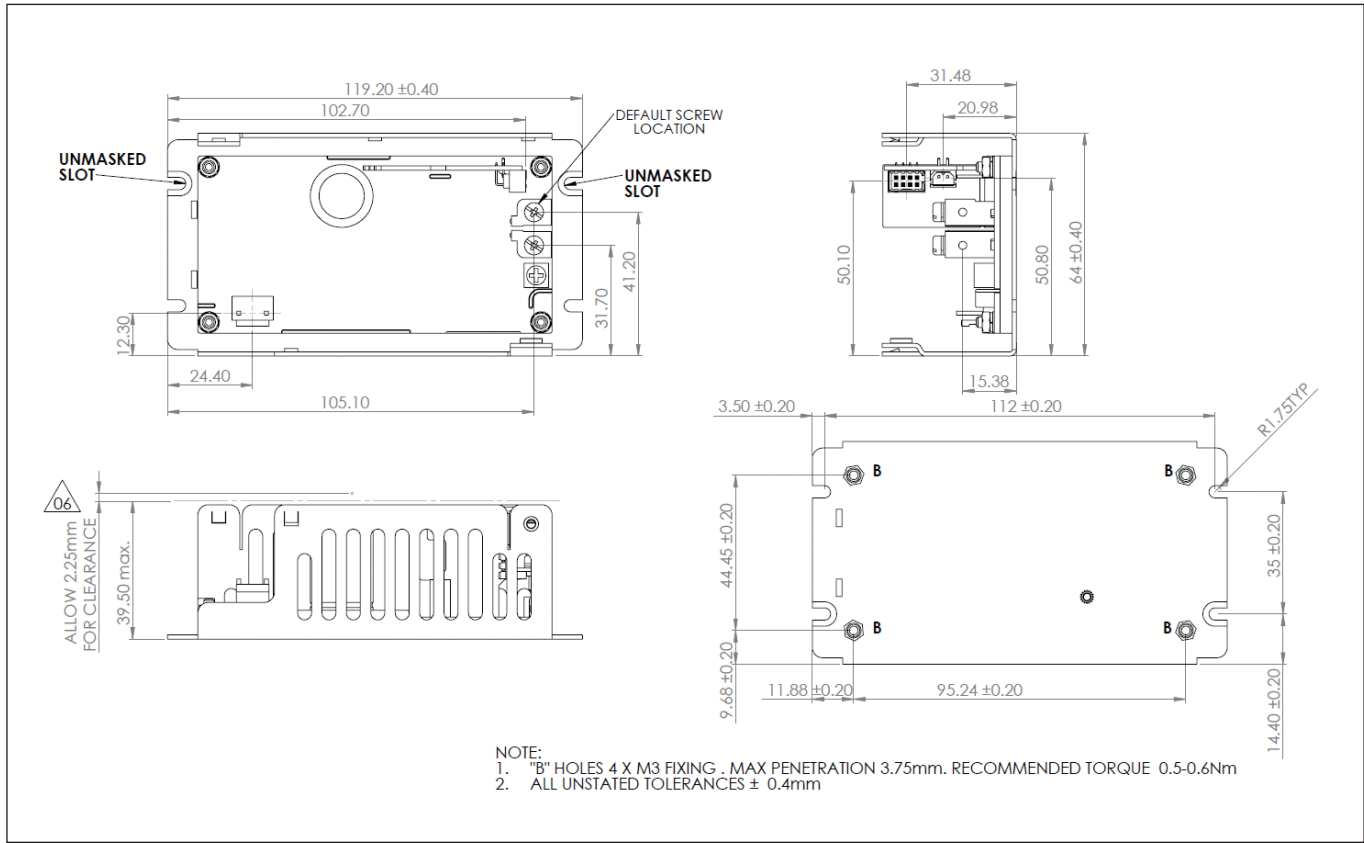

Outline Drawing CUS250M/A (U Channel with Cover) Option

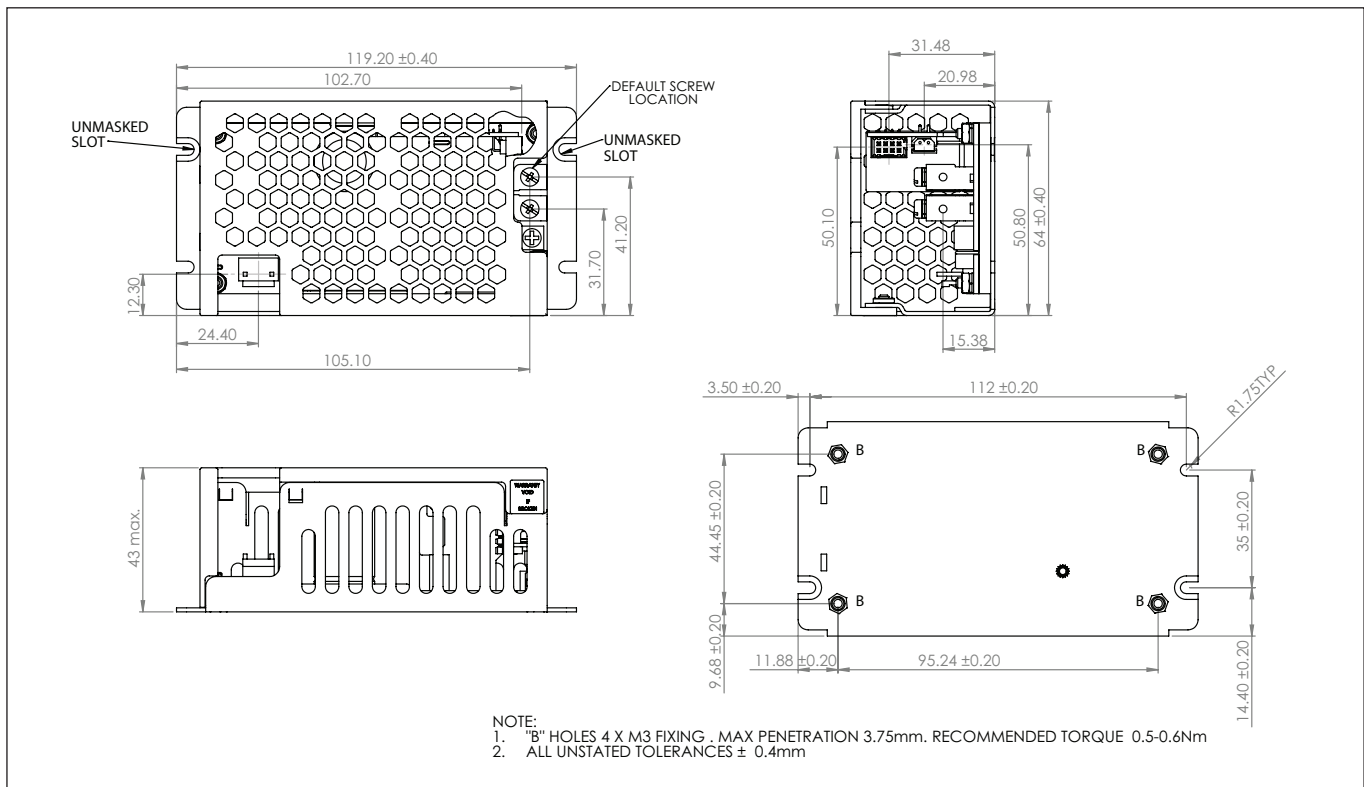

Outline Drawing CUS250M/F (U Channel with Cover & Top Mounted Fan) Option

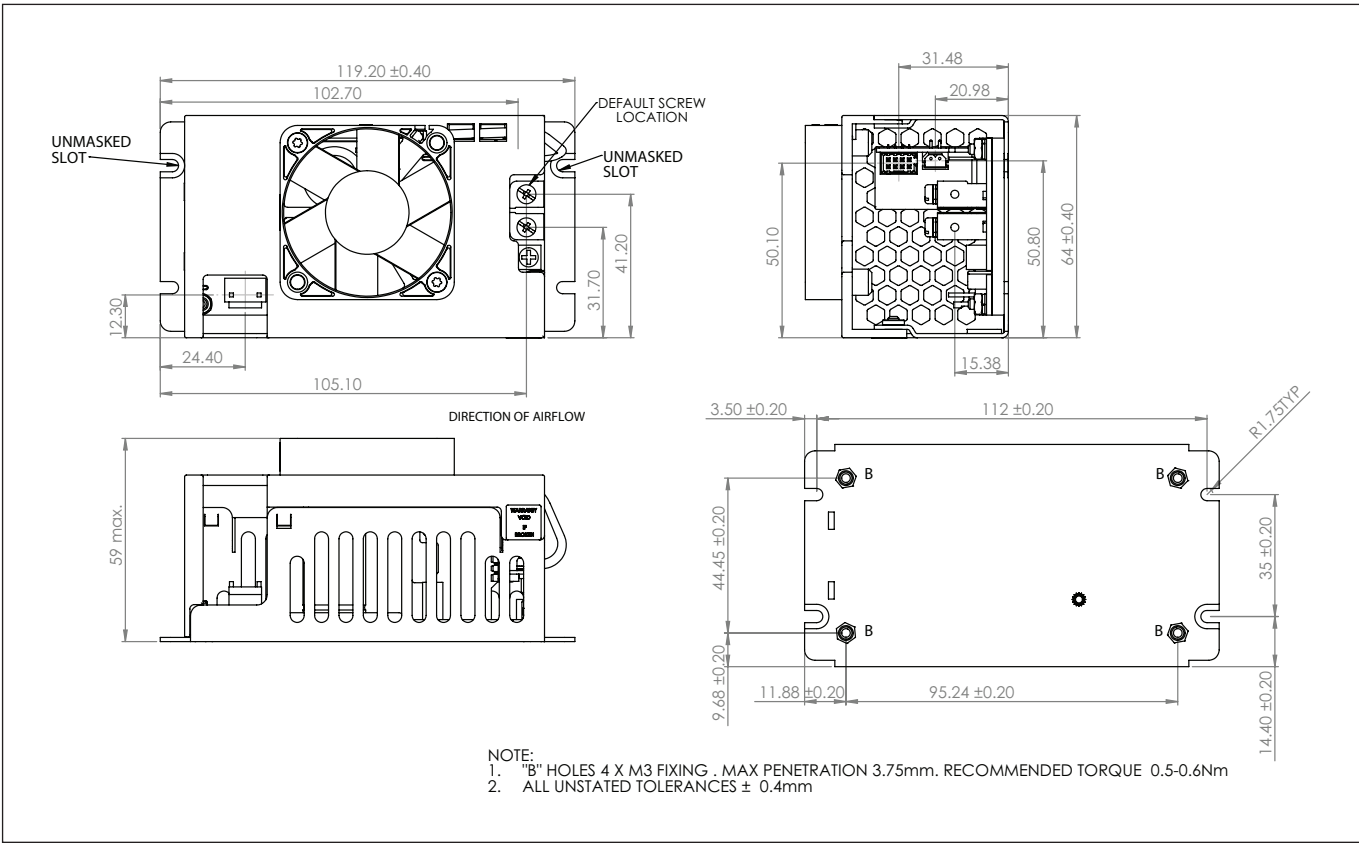



TDK-Lambda France SAS

Tel: +33 1 60 12 71 65
france@fr.tdk-lambda.com
www.emea.lambda.tdk.com/fr



Italy Sales Office

Tel: +39 02 61 29 38 63
info.italia@it.tdk-lambda.com
www.emea.lambda.tdk.com/it



Netherlands

info@nl.tdk-lambda.com
www.emea.lambda.tdk.com/nl



TDK-Lambda Germany GmbH

Tel: +49 7841 666 0
info@de.tdk-lambda.com
www.emea.lambda.tdk.com/de



Austria Sales Office

Tel: +43 2256 655 84
info@at.tdk-lambda.com
www.emea.lambda.tdk.com/at



Switzerland Sales Office

Tel: +41 44 850 53 53
info@ch.tdk-lambda.com
www.emea.lambda.tdk.com/ch



Nordic Sales Office

Tel: +45 8853 8086
info@dk.tdk-lambda.com
www.emea.lambda.tdk.com/dk



TDK-Lambda UK Ltd.

Tel: +44 (0) 12 71 85 66 66
info@uk.tdk-lambda.com
www.emea.lambda.tdk.com/uk



TDK-Lambda Ltd.

Tel: +9 723 902 4333
info@tdk-lambda.co.il
www.emea.lambda.tdk.com/il



C.I.S.

Commercial Support:

Tel: +7 (495) 665 2627

Technical Support:

Tel: +7 (812) 658 0463
info@tdk-lambda.ru
www.emea.lambda.tdk.com/ru



TDK-Lambda Americas

Tel: +1 800-LAMBDA-4 or 1-800-526-2324
powersolutions@us.tdk-lambda.com
www.us.lambda.tdk.com



TDK Electronics do Brasil Ltda

Tel: +55 11 3289-9599
sales.br@tdk-electronics.tdk.com
www.tdk-electronics.tdk.com/en



TDK-Lambda Corporation

Tel: +81-3-6778-1113
www.jp.lambda.tdk.com



TDK-Lambda (China) Electronics Co. Ltd.

Tel: +86 21 6485-0777
powersolutions@cn.tdk-lambda.com
www.lambda.tdk.com.cn



TDK-Lambda Singapore Pte Ltd.

Tel: +65 6251 7211
tis.mkt@sg.tdk-lambda.com
www.sg.lambda.tdk.com



TDK India Private Limited, Power Supply Division

Tel: +91 80 4039-0660
mathew.philip@in.tdk-lambda.com
www.sg.lambda.tdk.com

For Additional Information, please visit
<https://product.tdk.com/en/power/>

