



**SiC SCHOTTKY DIODE TYPE 2×100A**

Preliminary

**Features**

- High surge current capable
- Zero reverse recovery current
- High bandwidth
- Isolation type package
- Temperature Independent Switching Behavior
- VDC 1200 V
- I<sub>F</sub> (T<sub>C</sub><135°C) 2×100 A

**Benefits**

- Unipolar rectifier
- Zero switching loss
- Higher efficiency
- Smaller heat sink
- Parallel devices without thermal runaway

**Applications**

- Motor drives
- Switch mode power supplies
- Ev chargers
- Solar inverters
- Welding equipment
- Power factor correction
- Diode snubber
- Automotive
- induction heating

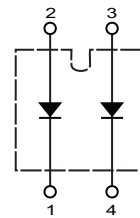
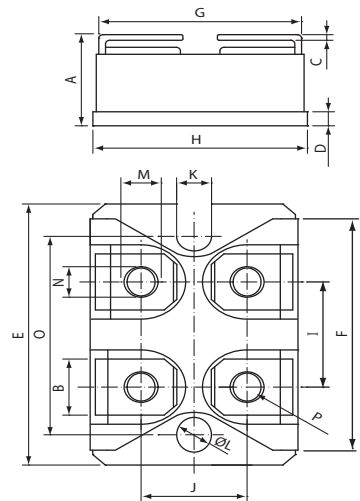

CSRI 2X100 - XXX

**Maximum Ratings**

Operating Junction Temperature : - 55 °C to +175 °C

Storage Temperature : -55 °C to +175 °C

Part Number	Maximum Recurrent Peak Reverse Voltage	Maximum DC Blocking Voltage
CSRI2×100-120	1200V	1200V

Maximum Rating	Symbol	Conditions	Value	Unit
Continuous forward current (per leg)	I <sub>F</sub>	T <sub>C</sub> =135 °C	100	A
Surge non-repetitive forward current sine halfwave (per leg)	I <sub>FSM</sub>	T <sub>C</sub> =25 °C, t <sub>p</sub> =8.3 ms	800	
		T <sub>C</sub> =150 °C, t <sub>p</sub> =8.3 ms	500	
Non-repetitive peak forward current (per leg)	I <sub>F,max</sub>	T <sub>C</sub> =25 °C, t <sub>p</sub> =10 μs	3200	
		T <sub>C</sub> =150 °C, t <sub>p</sub> =10 μs	2000	
Repetitive peak reverse voltage	V <sub>RRM</sub>	T <sub>J</sub> =25 °C	1200	V
Isolation voltage	V <sub>iso</sub>	50/60 Hz, RMS I <sub>ISOL</sub> 1 ≤ mA	2500	V
Mounting torque		M4 Screw	1.1	N-m

DIM	DIMENSIONS			
	INCHES		MM	
	MIN	MXA	MIN	MXA
A	.500	.519	12.70	13.20
B	.307	.322	7.80	8.20
C	.029	.033	.75	.84
D	.077	.082	1.95	2.10
E	1.487	1.502	37.80	38.20
F	1.250	1.258	31.75	32.00
G	.931	.956	23.65	24.30
H	.996	1.012	25.30	25.70
I	.586	.594	14.90	15.10
J	.492	.516	12.50	13.10
K	.161	.169	4.10	4.30
L	.161	.169	4.10	4.30
M	.181	.191	4.60	4.95
N	.165	.177	4.20	4.50
O	1.184	1.192	30.10	30.30
P	M4*8			



Electrical Characteristics, at  $T_j=25\text{ }^\circ\text{C}$ , unless otherwise specified. (per leg)

Static Characteristics	Symbol	Conditions	Values			Unit
			min.	typ.	max.	
DC blocking voltage	$V_{DC}$		1,200	-	-	V
Diode forward voltage	$V_F$	$I_F=100\text{A}, T_j=25\text{ }^\circ\text{C}$	-	1.6	1.8	
		$I_F=100\text{A}, T_j=175\text{ }^\circ\text{C}$	-	2.4	2.9	
Reverse current	$I_R$	$V_R=1,200\text{V}, T_j=25\text{ }^\circ\text{C}$	-	3.6	181	$\mu\text{A}$
		$V_R=1,200\text{V}, T_j=175\text{ }^\circ\text{C}$	-	230	2,300	

AC Characteristics (per leg)

Static Characteristics	Symbol	Conditions	Values			Unit
			min.	typ.	max.	
Total capacitive charge	$Q_{rr}$	$V_R=1,200\text{V}, T_j=25\text{ }^\circ\text{C}$	-	309	-	nC
Total capacitance	C	$V_R=0\text{V}, f=1\text{ MHz}$ $T_j=25\text{ }^\circ\text{C}$	-	5570	-	pF
		$V_R=600\text{V}, f=1\text{ MHz}$ $T_j=25\text{ }^\circ\text{C}$	-	553	-	
		$V_R=1,000\text{V}, f=1\text{ MHz}$ $T_j=25\text{ }^\circ\text{C}$	-	518	-	

Thermal Characteristics (per leg)

Static Characteristics	Symbol	Values	Unit
		typ.	
Thermal resistance from junction to case	$R_{\theta JC}$	0.14	$^\circ\text{C/W}$



Typical Performance

Forward Characteristics (parameterized on  $T_j$ )

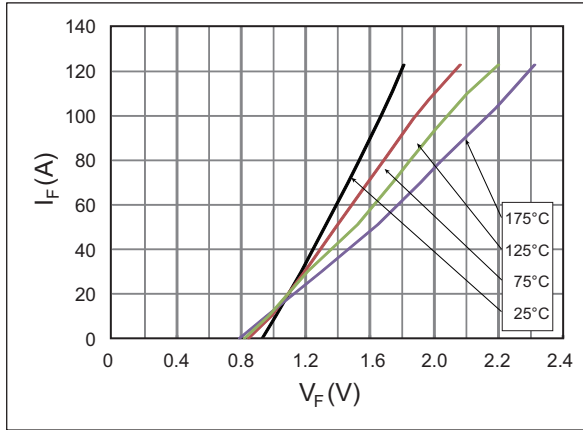

Reverse Characteristics (parameterized on  $T_j$ )

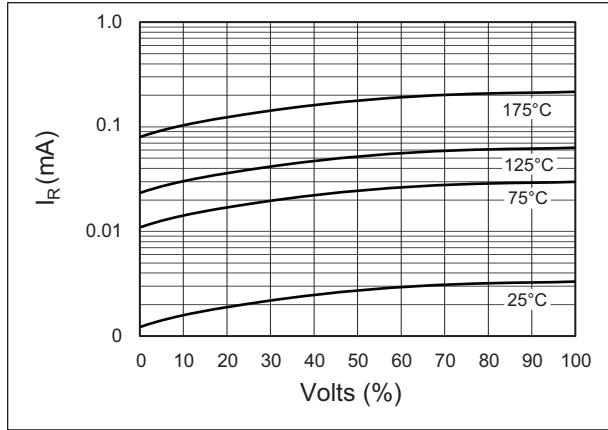

Capacitance

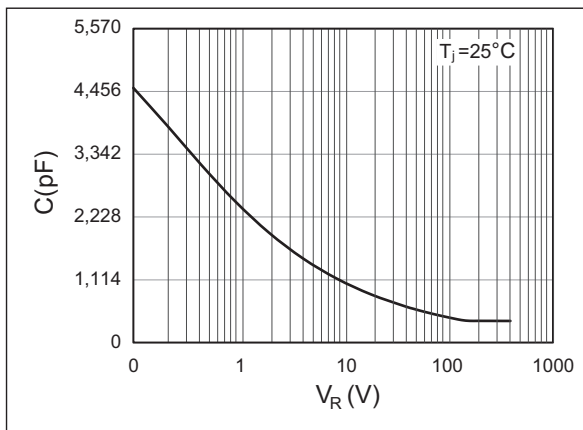

Current Derating

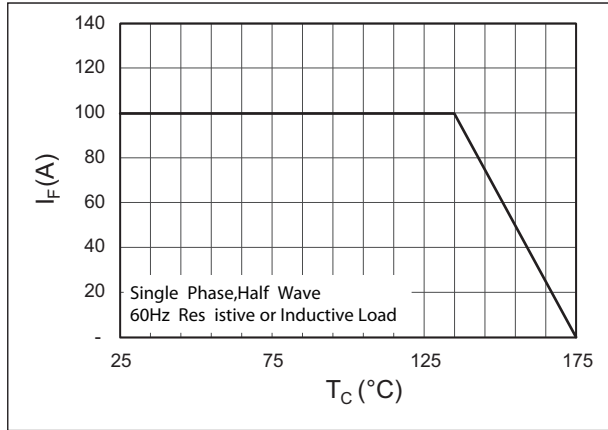

Recovery Charge

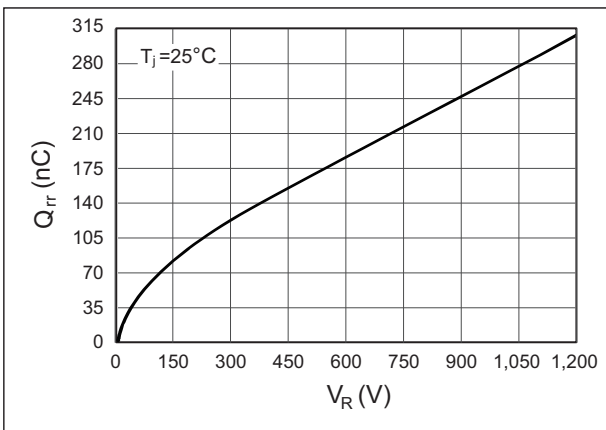

Forward Surge Current

