



CFM20S SERIES 20 WATT OPEN FRAME AC-DC MODULES

Features

- Universal Input Range 90~264V_{ac}
- High Efficiency up to 87%
- 1.30"x 2.38" Size
- Class II
- No Load Power <0.1W
- Approval IEC/EN/UL 62368-1
- Design Meets IEC/EN 60335-1
- Approval EN 55032 Class B and CISPR/FCC Class B
- Operating Altitude 5000m
- Continuous Short Circuit Protection
- Over Voltage Protection



MODEL NUMBER	OUTPUT VOLTAGE	OUTPUT CURRENT	VOLTAGE ACCURACY NOTE1	RIPPLE & NOISE NOTE2	LINE REGULATION NOTE3	LOAD REGULATION NOTE4	%EFF. (Typ.) NOTE5
CFM20S050	5 V	4.0 A	±2%	100 mV	±0.5%	±1%	84%
CFM20S120	12 V	1.67 A	±2%	120 mV	±0.5%	±1%	86%
CFM20S150	15 V	1.34 A	±2%	150 mV	±0.5%	±1%	86%
CFM20S240	24 V	0.83 A	±2%	240 mV	±0.5%	±1%	86%
CFM20S480	48 V	0.42 A	±2%	480 mV	±0.5%	±1%	87%

Note:

1. Voltage accuracy is set at 100% full load.
2. Add a 0.1uF ceramic capacitor and a 10uF E.L. capacitor to output for ripple & noise measurement @20MHz B.W.
3. Line regulation is measured from high line to low line with 100% full load.
4. Load regulation is measured from 10% to 100% full load.
5. Typical efficiency at 230 V_{ac} and 100% full load at 25°C.
6. T Version wafer with JST B3B-XH / B4B-XH and mate with JST housing XH series or equivalent

PART NUMBER

Series	Number of Outputs	Nominal Output Voltage	Type
CFM20	X	XXX	-X (Option)
CFM20	S : Single	050 : 05V 120 : 12V 150 : 15V 240 : 24V 480 : 48V	Blank : PCB mount T : Wafer E : Encapsulated

Part Number Example:

CFM20S120: 20W, Single 12Vdc Output, PCB Mount Type

CFM20S120-T: 20W, Single 12Vdc Output, Wafer Type



CFM20S Series

TECHNICAL SPECIFICATIONS

(All specifications are typical at nominal input, 100% full load at 25°C unless otherwise noted.)

ABSOLUTE MAXIMUM RATINGS

PARAMETER	NOTES and CONDITIONS	Device	Min.	Typ.	Max.	Units
Input Voltage	Safety approvals only to the AC input	All	90		264	V_{ac}
				120		370
Operating Temperature	See Derating Curve	All	-40		80	°C
Storage Temperature		All	-40		85	°C
Operating Altitude	IEC/EN/UL 62368-1	All			5000	m
	Design Meets IEC/EN 60335-1				3000	

INPUT CHARACTERISTICS

PARAMETER	NOTES and CONDITIONS	Device	Min.	Typ.	Max.	Units
Operating Voltage Range		All	100		240	V_{ac}
Input Frequency Range		All	50		60	Hz
Maximum Input Current	100% full load, $V_{in}=100V_{ac}$	All			0.6	A
Leakage Current		All			0.1	mA
Inrush Current	$V_{in}=240V_{ac}$, Cold start at 25°C	All		35		A

OUTPUT CHARACTERISTICS

PARAMETER	NOTES and CONDITIONS	Device	Min.	Typ.	Max.	Units
Output Voltage Set Point	V_{in} =Nominal V_{in} , $I_o=I_o$ max., $T_c=25^\circ C$	CFM20S050	4.90	5	5.10	V_{dc}
		CFM20S120	11.76	12	12.24	
		CFM20S150	14.70	15	15.30	
		CFM20S240	23.52	24	24.48	
		CFM20S480	47.04	48	48.96	
Operating Output Current Range	$V_{in}=90V_{ac} \sim 264V_{ac}$, See Derating Curve	CFM20S050			4.00	A
		CFM20S120			1.67	
		CFM20S150			1.34	
		CFM20S240			0.83	
		CFM20S480			0.42	
Holdup Time	$V_{in}=115V_{ac}$	All		8		ms
Output Voltage Regulation						
Load Regulation	10% load to 100% full load	All			± 1.0	%
Line Regulation	V_{in} =High line to low line	All			± 0.5	%
Over Current Protection	Hiccup mode (Auto recovery)	All	110		180	%
Short Circuit Protection	Auto recovery	All				
Over Voltage Protection	Latch mode (AC recycle to restart)	CFM20S050			8.0	V_{dc}
		CFM20S120			16.5	
		CFM20S150			19.6	
		CFM20S240			31.5	
		CFM20S480			60.0	



CFM20S Series

PARAMETER	NOTES and CONDITIONS	Device	Min.	Typ.	Max.	Units
Output Ripple and Noise	1. Add a 0.1uF ceramic capacitor and a 10uF aluminum electrolytic capacitor to output 2. Oscilloscope is 20MHz bandwidth 3. Ambient temperature=25°C	CFM20S050			100	mV
		CFM20S120			120	
		CFM20S150			150	
		CFM20S240			240	
		CFM20S480			480	
Load Capacitance	1. $V_{in}=115V_{ac}$ and $230V_{ac}$ 2. Output is 100% full load 3. Ambient temperature=25°C	CFM20S050			4000	uF
		CFM20S120			1670	
		CFM20S150			1340	
		CFM20S240			830	
		CFM20S480			420	
Efficiency	1. $V_{in}=230V_{ac}$ 2. Output is 100% full load 3. Ambient temperature=25°C	CFM20S050		84		%
		CFM20S120		86		
		CFM20S150		86		
		CFM20S240		86		
		CFM20S480		87		

ISOLATION CHARACTERISTICS

PARAMETER	NOTES and CONDITIONS	Device	Min.	Typ.	Max.	Units
Input to Output	1 minute	All			3000	V_{ac}
Isolation Resistance	Input to Output	All	100			MΩ

FEATURE CHARACTERISTICS

PARAMETER	NOTES and CONDITIONS	Device	Min.	Typ.	Max.	Units
Switching Frequency	$P_{out}=\max.$ rated power	All		65		kHz

GENERAL SPECIFICATIONS

PARAMETER	NOTES and CONDITIONS	Device	Min.	Typ.	Max.	Units
MTBF	$I_o=100\%$; $T_a=25^\circ C$ per MIL-HDBK-217F	All	1300			k hours
Humidity	Non-condensing	All			93	% RH
Shock	Meet MIL-STD-810F Table 516.5, Table 516.5-I 10ms, each axis 3 times($\pm X$ 、 $\pm Y$ 、 $\pm Z$ axis)	All		75		g
Vibration	Meet MIL-STD-810F Table 514.5C-VIII, 15~2000Hz, X、Y、Z axis, 1 hour (each axis),. Total 3 hrs.	All		4		g
Weight	Blank (PCB mount)	All		35		grams
	E (Encapsulated)			95		
	T (Wafer)			36		
Dimensions	Blank (PCB mount)	All	2.38x1.30x0.906 Inches (60.5x33.0x23.00 mm)			
	E (Encapsulated)		2.48x1.40x0.933 Inches (63.0x35.6x23.70 mm)			
	T (Wafer)		3.00x1.30x0.831 Inches (76.2x33.0x21.10 mm)			
Safety	Class II, IEC/EN/UL 62368-1					
EMC Emission	EN 55032:2015+A11:2020, 47 CFR FCC Part 15 Subpart B, ICES-003 Issue7, EN 61204-3:2000, EN 61000-6-3:2007+A1:2011+AC:2012, EN 61000-3-2:2019, EN 61000-3-3:2013+A1:2019					Class B
Conducted Disturbance	EN 55032:2015+A11:2020, 47 CFR FCC Part 15 Subpart B, ICES-003 Issue7, EN 61204-3:2000, EN 61000-6-3:2007+A1:2011+AC:2012					Class B
Radiated Disturbance	EN 55032:2015+A11:2020, 47 CFR FCC Part 15 Subpart B, ICES-003 Issue7, EN 61204-3:2000, EN 61000-6-3:2007+A1:2011+AC:2012					Class B
Harmonic Current Emissions	EN 61000-3-2:2019					
Voltage Fluctuations & Flicker	EN 61000-3-3:2013+A1:2019					
EMC Immunity	EN 55035:2017+A11:2020, EN 61204-3:2000, EN 61000-6-1:2007					
Electrostatic Discharge (ESD)	IEC 61000-4-2:2008					Criterion A



CFM20S Series

GENERAL SPECIFICATIONS

Radio-Frequency, Continuous Radiated Disturbance	IEC 61000-4-3:2020	Criterion A
Electrical Fast Transient (EFT)	IEC 61000-4-4:2012, $\pm 0.5\text{kV}$, $\pm 1\text{kV}$	Criterion A
Surge	IEC 61000-4-5:2014+A1:2017, L-N: $\pm 0.5\text{kV}$, $\pm 1\text{kV}$	Criterion A
Conducted Disturbances, Induced by RF Fields	IEC 61000-4-6:2013	Criterion A
Power Frequency Magnetic Field	IEC 61000-4-8:2009	Criterion A
Voltage Dips	IEC 61000-4-11:2020, Dip: 30% Reduction, Dip >95% Reduction	Criterion A
Voltage Interruptions	IEC 61000-4-11:2020, >95% Reduction	Criterion B
Application Note Link	CFM20S Series App Notes	

CHARACTERISTIC CURVE

Power Derating Curve

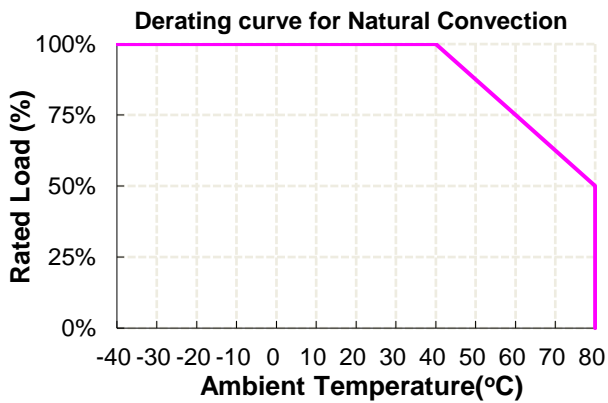

Performance Data

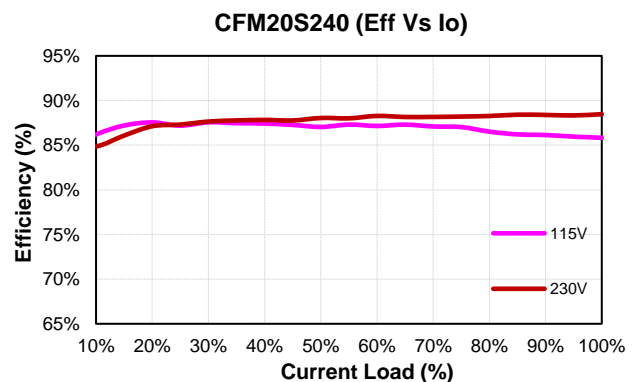
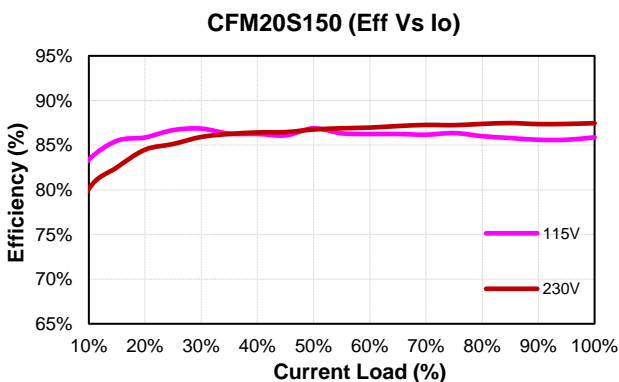
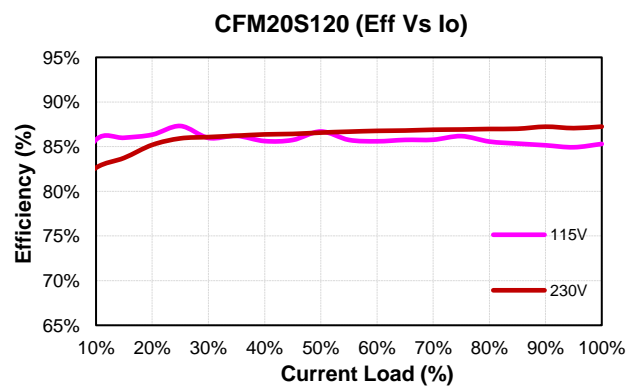
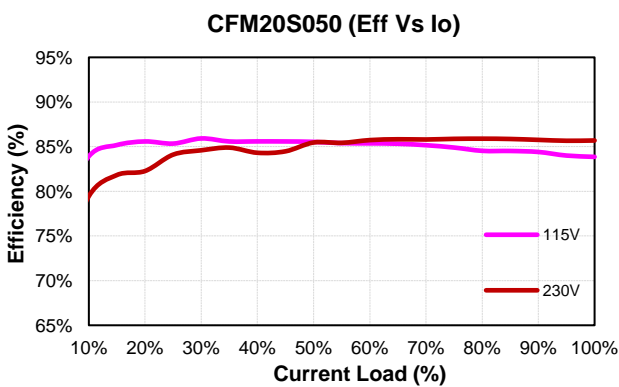



CFM20S Series

CFM20S480 (Eff Vs Io)

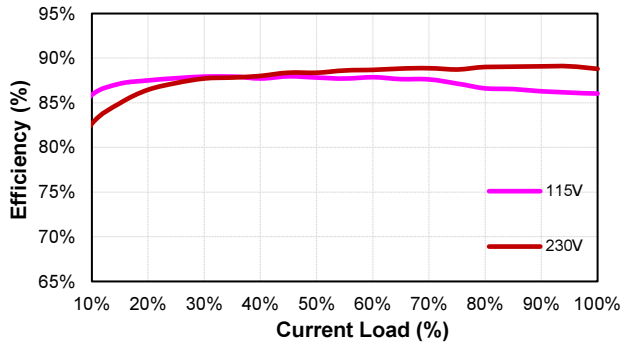

MECHANICAL SPECIFICATION

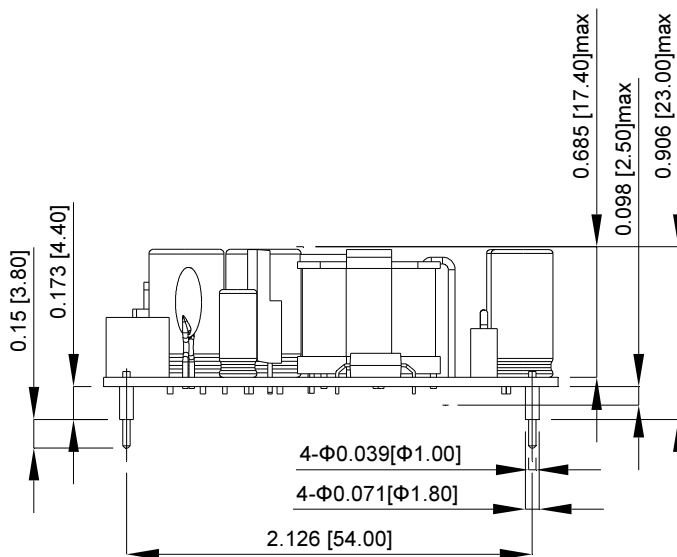
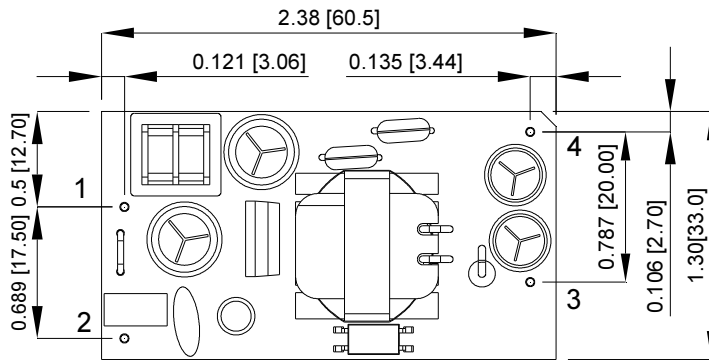

PIN CONNECTION	
Pin	Function
1	ACN
2	ACL
3	+Vout
4	-Vout

All Dimensions In Inches[mm]
 Tolerance Inches: x.xx=±0.03 x.xxx= ± 0.020
 Millimeters: x.x=±0.7 x.xx = ± 0.50



MECHANICAL SPECIFICATION

CFM20SXXX-E

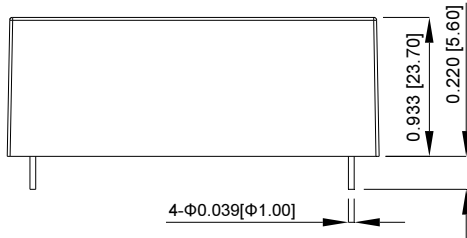

BOTTOM VIEW

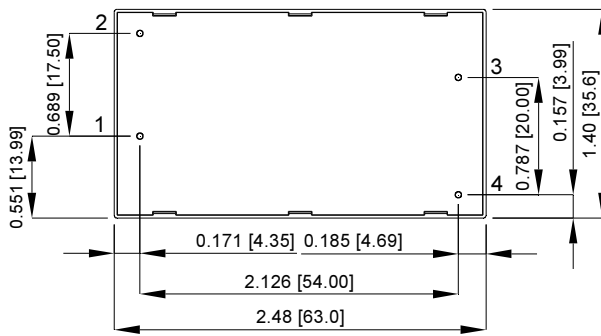

PIN CONNECTION	
Pin	Function
1	ACN
2	ACL
3	+Vout
4	-Vout

All Dimensions In Inches[mm]
 Tolerance Inches: x.xx=±0.03 x.xxx= ± 0.020
 Millimeters: x.x=±0.7 x.xx = ± 0.50

CFM20SXXX-T

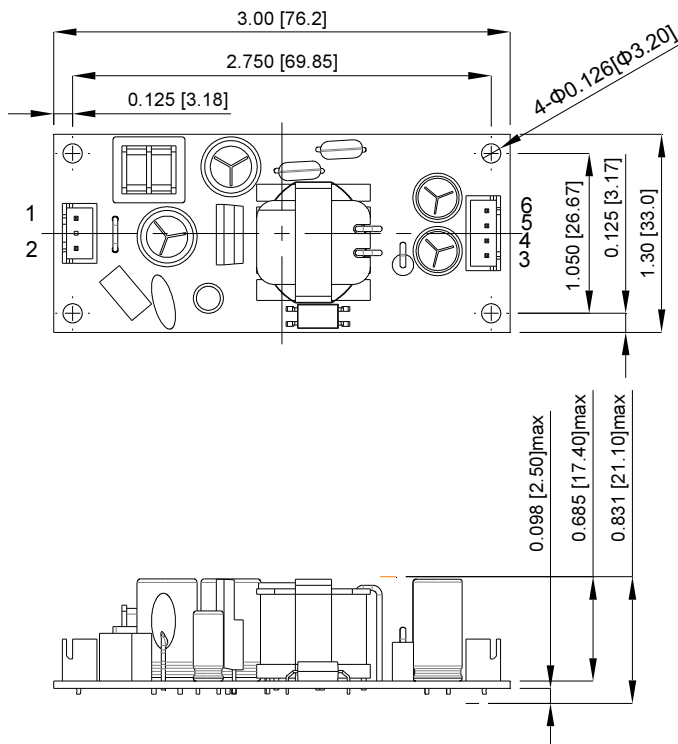

PIN CONNECTION	
Pin	Function
1	ACN
2	ACL
3	+Vout
4	+Vout
5	-Vout
6	-Vout

All Dimensions In Inches[mm]
 Tolerance Inches: x.xx=±0.03 x.xxx= ± 0.020
 Millimeters: x.x=±0.7 x.xx = ± 0.50

CINCON Electronics Co. Ltd.
 Add: 14F, No. 306, Sec.4, Hsin Yi Rd., Taipei, Taiwan
 Tel: 886-2-27086210
 Fax: 886-2-27029852
 E-mail: sales@cincon.com.tw
 Web: www.cincon.com