

BOOM-M

~30° medium beam. Assembly with 0.2 mm thick installation tape.

TECHNICAL SPECIFICATIONS:

Dimensions	22.2 mm
Height	14.3 mm
Fastening	tape
Colour	metal
Box size	480 x 280 x 300 mm
Box weight	5.4 kg
Quantity in Box	1680 pcs
ROHS compliant	yes ⓘ



MATERIAL SPECIFICATIONS:

Component	Type	Material	Colour
BOOM-M	Reflector	PC	metal
BOOM-TAPE	Tape	PU tape 0,25mm	

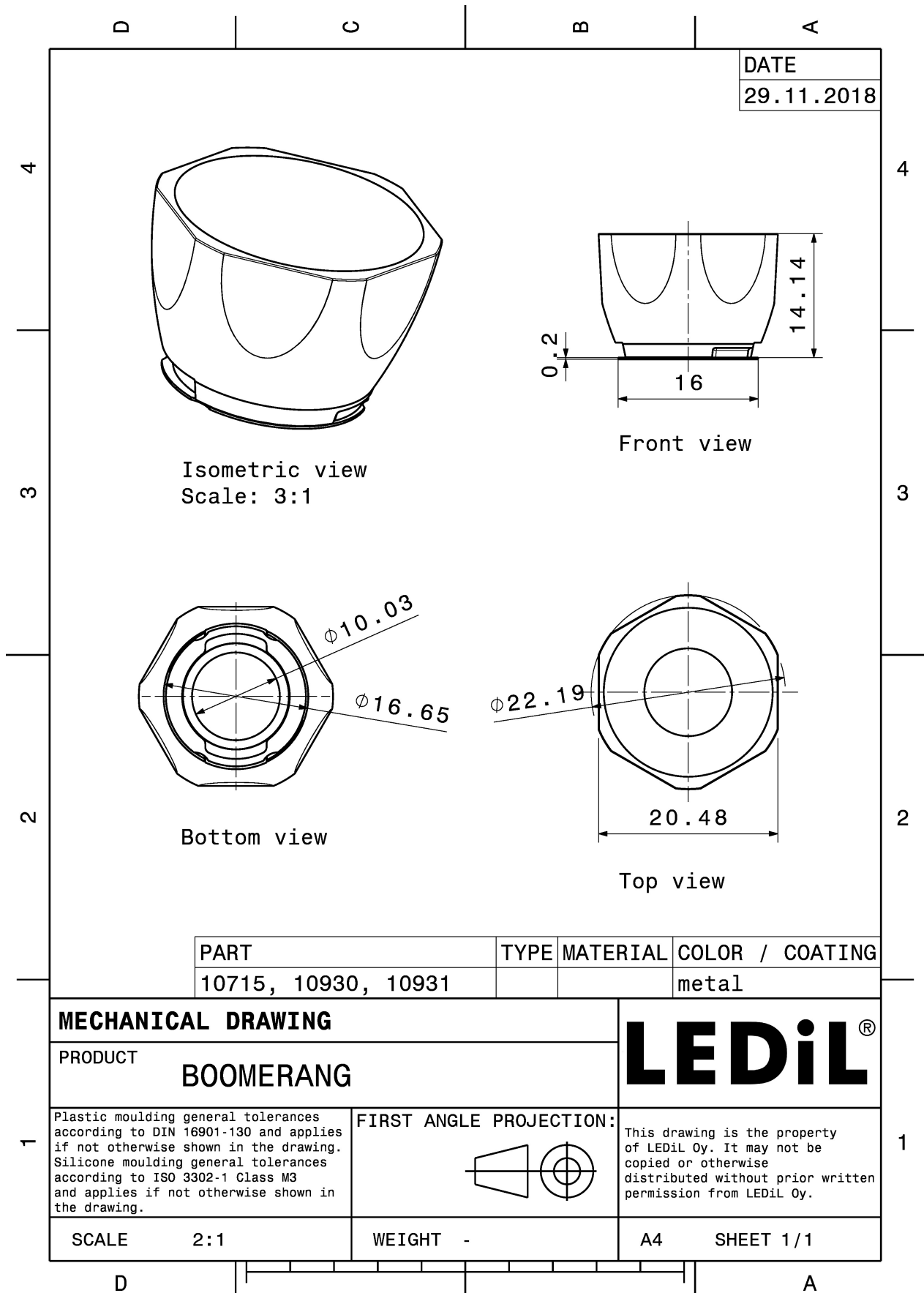

PHOTOMETRIC DATA (MEASURED):



LED MHB-A/B
 FWHM 31.0°
 Efficiency 82 %
 Peak intensity 2.230 cd/lm
 LEDs/each optic 1
 Light colour White
 Required components:

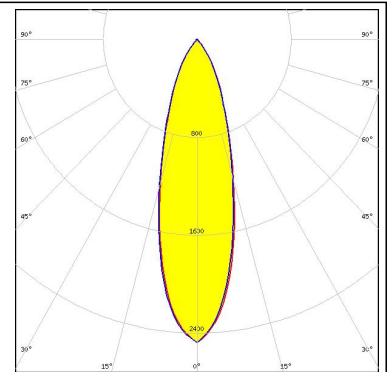
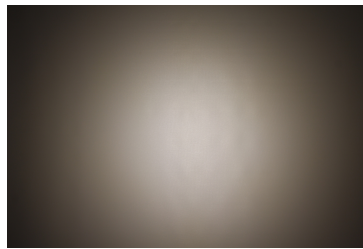

LED MHD-E/G
 FWHM 34.0°
 Efficiency 82 %
 Peak intensity 1.700 cd/lm
 LEDs/each optic 1
 Light colour White
 Required components:

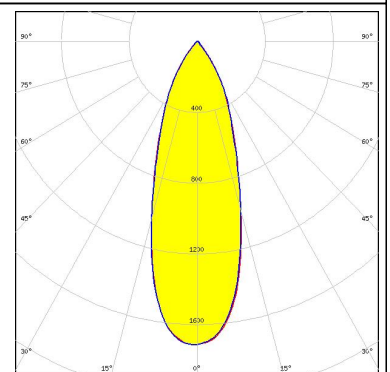
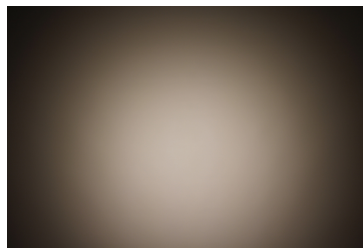

LED LUXEON M/MX
 FWHM 30.0°
 Efficiency 79 %
 Peak intensity 2.240 cd/lm
 LEDs/each optic 1
 Light colour White
 Required components:

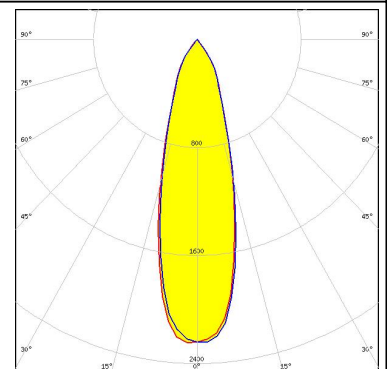
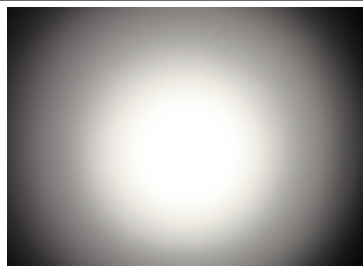

LED LUXEON MZ
 FWHM 20.0°
 Efficiency 75 %
 Peak intensity 4.000 cd/lm
 LEDs/each optic 1
 Light colour White
 Required components:

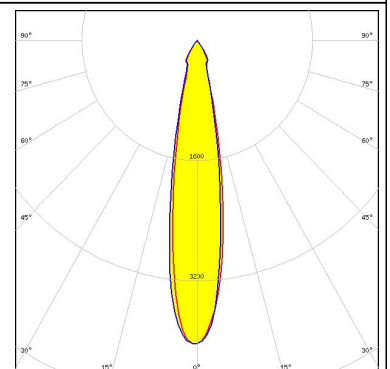
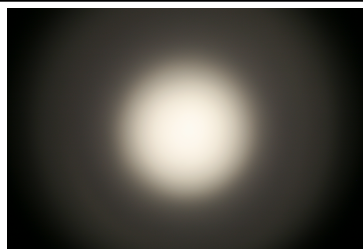

PHOTOMETRIC DATA (MEASURED):



LED NFMW48xA
FWHM 23.0°
Efficiency 80 %
Peak intensity 3.100 cd/lm
LEDs/each optic 1
Light colour White
Required components:

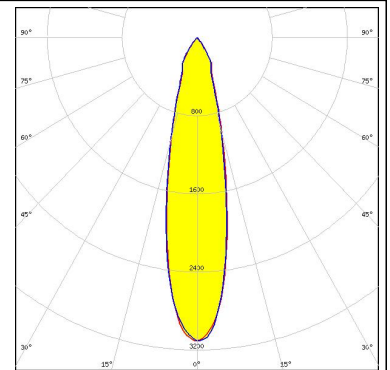

LED Duris S10
FWHM 28.0°
Efficiency 74 %
Peak intensity 2.500 cd/lm
LEDs/each optic 1
Light colour White
Required components:

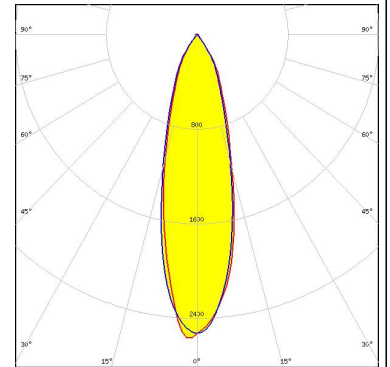
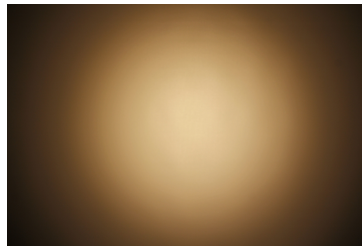

SEOL SEMICONDUCTOR

LED P7
FWHM 33.0°
Efficiency %
Peak intensity 1.860 cd/lm
LEDs/each optic 1
Light colour White
Required components:

PHOTOMETRIC DATA (SIMULATED):

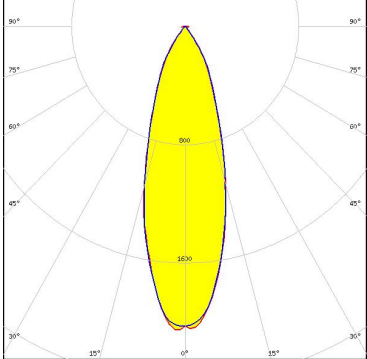
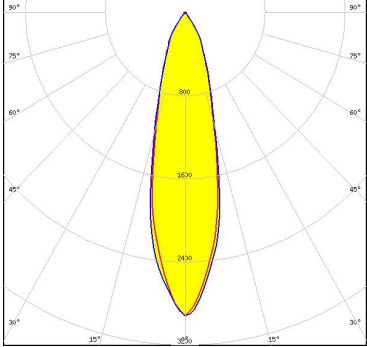
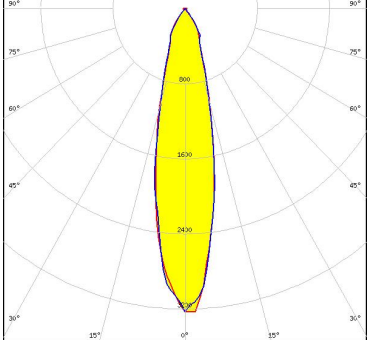
<p>NICHIA</p> <p>LED COB S-Type (LES 7) FWHM 31.6° Efficiency 82 % Peak intensity 2.100 cd/lm LEDs/each optic 1 Light colour White Required components:</p>	
<p>OSRAM Opto Semiconductors</p> <p>LED Duris S8 FWHM 25.7° Efficiency 87 % Peak intensity 2.920 cd/lm LEDs/each optic 1 Light colour White Required components:</p>	
<p>OSRAM Opto Semiconductors</p> <p>LED OSCONIQ P 7070 FWHM 25.0° Efficiency 85 % Peak intensity 3.320 cd/lm LEDs/each optic 1 Light colour White Required components:</p>	

GENERAL INFORMATION:

NOTE: The typical beam angle will be changed by different color, chip size and chip position tolerance. The typical total beam angle is the full angle measured where the luminous intensity is half of the peak value.

Due to use of high power COB's with this product, special attention to proper thermal design is highly recommended. LEDiL has no liability for direct, indirect or consecutive damages arising from the LEDiL products being used outside of the recommended temperature range.

MATERIALS:

As part of our continuous research and improvement processes, and to ensure the best possible quality and availability of our products, LEDiL reserves the right to change material grades without notice.

PRODUCT DATA USER AGREEMENT AND DISCLAIMER:

The measured data in the provided downloadable LEDiL Product Datasheets and Mechanical 2D-Drawings is rounded and provided as reference for planning. LEDiL Oy's optical specifications have been verified by conducting performance testing of the products in accordance with the company's quality system. The reported data are averaged results of multiple measurements with typical variation. LEDiL Oy reserves the right to without prior notification make changes and improvements to its products.

LEDiL Oy assumes neither warranty, nor guarantee nor any other liability of any kind for the contents and correctness of the provided data. The provided data has been generated with highest diligence but the provided data may in reality not represent the complete possible variation range of all intrinsic parameters. Therefore, in certain cases a deviation from the provided data could occur.

LEDiL Oy reserves the right to undertake technical changes of its products without further notification which could lead to changes in the provided data. LEDiL Oy assumes no liability of any kind for the possible deviation from any provided data or any other damage resulting from the usage of the provided data.

The user agrees to this disclaimer and user agreement with the download or usage of the provided files.

LEDiL Oy

Joensuunkatu 13
FI-24240 SALO
Finland

LEDiL Inc.

228 West Page Street
Suite D
Sycamore IL 60178
USA

Local sales and technical support

[www.ledil.com/
where_to_buy](http://www.ledil.com/where_to_buy)

Shipping locations

Salo, Finland
Hong Kong, China

Distribution Partners

[www.ledil.com/
where_to_buy](http://www.ledil.com/where_to_buy)