

## C106 Series

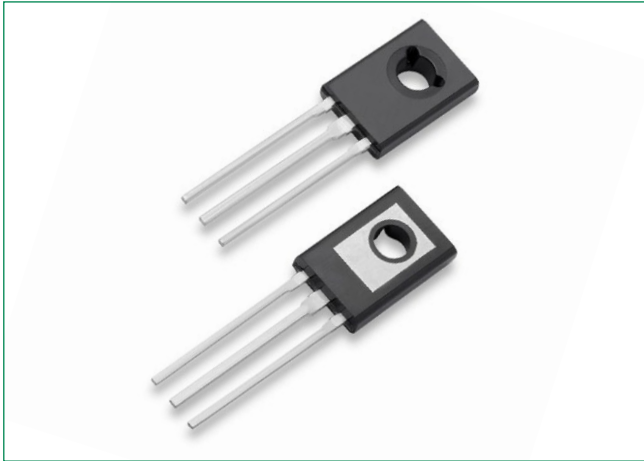

### Description

Glassivated PNP devices designed for high volume consumer applications such as temperature, light, and speed control; process and remote control, and warning systems where reliability of operation is important.

### Features

- Glassivated Surface for Reliability and Uniformity
- Power Rated at Economical Prices
- Practical Level Triggering and Holding Characteristics
- Flat, Rugged, Thermopad Construction for Low Thermal Resistance, High Heat Dissipation and Durability
- Sensitive Gate Triggering
- These are Pb-Free Devices

### Pin Out

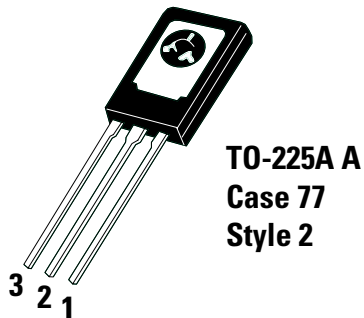

### Functional Diagram



### Additional Information



Datasheet



Resources



Samples

### Maximum Ratings ( $T_J = 25^\circ\text{C}$ unless otherwise noted)

Rating	Symbol	Value	Unit
Peak Repetitive Off-State Voltage (Sine Wave, 50–60 Hz, RGK = 1 K, TC = -40° to 110°C)	$V_{DRM}^*$ $V_{RRM}$	200 400 600	V
On-State RMS Current (180° Conduction Angles, TC = 80°C)	$I_T$ (RMS)	4.0	A
Average On-State Current (180° Conduction Angles, $T_c = 80^\circ\text{C}$ )	$I_{T(AV)}$	2.55	A
Peak Non-Repetitive Surge Current (1/2 Cycle, Sine Wave, 60 Hz, $T_J = +25^\circ\text{C}$ )	$I_{TSM}$	20	A
Circuit Fusing Considerations ( $t = 8.3$ ms)	$I^2t$	1.65	A2s
Forward Peak Gate Current (Pulse Width 1.0 sec, TC = 80°C)	$I_{GM}$	0.2	A
Forward Peak Gate Power (Pulse Width $\leq 1.0$ $\mu\text{sec}$ , $T_c = 80^\circ\text{C}$ )	$P_{GM}$	0.5	W
Forward Average Gate Power (Pulse Width $\leq 1.0$ $\mu\text{sec}$ , $T_c = 80^\circ\text{C}$ )	$P_{G(AV)}$	0.1	W
Operating Junction Temperature Range	$T_J$	-40 to +110	°C
Storage Temperature Range	$T_{stg}$	-40 to +150	°C
Mounting Torque (Note 2)	–	6.0	in. lb.

Stresses exceeding Maximum Ratings may damage the device. Maximum Ratings are stress ratings only. Functional operation above the Recommended Operating Conditions is not implied. Extended exposure to stresses above the Recommended Operating Conditions may affect device reliability.

- $V_{DRM}$  and  $V_{RRM}$  for all types can be applied on a continuous basis. Ratings apply for zero or negative gate voltage; however, positive gate voltage shall not be applied concurrent with negative potential on the anode. Blocking voltages shall not be tested with a constant current source such that the voltage ratings of the devices are exceeded.
- Torque rating applies with use of torque washer (Shakeproof WD19523 or equivalent). Mounting Torque in excess of 6 in. lb. does not appreciably lower case-to-sink thermal resistance. Main terminal 2 and heat-sink contact pad are common.

### Thermal Characteristics

Rating	Symbol	Value	Unit
Thermal Resistance, Junction-to-Case (AC) Junction-to-Ambient	$R_{\theta JC}$ $R_{\theta JA}$	3.0 75	°C/W
Maximum Lead Temperature for Soldering Purposes, 1/8" from case for 10 seconds	$T_L$	260	°C

### Electrical Characteristics - OFF ( $T_J = 25^\circ\text{C}$ unless otherwise noted)

Characteristic	Symbol	Min	Typ	Max	Unit	
Peak Repetitive Forward or Reverse Blocking Current ( $V_{AK} = \text{Rated } V_{DRM} \text{ or } V_{RRM}^*$ , $R_{GK} = 1 \text{ k}\Omega$ )	$I_{DRM}^*$ , $I_{RRM}$	$T_J = 25^\circ\text{C}$	–	–	10	$\mu\text{A}$
		$T_J = 110^\circ\text{C}$	–	–	100	$\mu\text{A}$

### Electrical Characteristics - ON ( $T_J = 25^\circ\text{C}$ unless otherwise noted)

Characteristic	Symbol	Min	Typ	Max	Unit	
Peak Forward On-State Voltage (Note 3) ( $I_{TM} = 4$ A)	$V_{TM}$	–	–	2.2	V	
Gate Trigger Current (Continuous dc) ( $V_D = 12$ V, $R_L = 100 \Omega$ , All Quadrants)	$I_{GT}$	$T_J = 25^\circ\text{C}$	–	15	200	$\mu\text{A}$
		$T_J = -40^\circ\text{C}$	–	35	500	$\mu\text{A}$
Peak Reverse Gate Voltage ( $I_{GR} = 10 \mu\text{A}$ )	$V_{GRM}$	–	–	6.0	V	
Gate Trigger Voltage (Continuous dc) ( $V_D = 12$ Vdc, $R_L = 100 \Omega$ , $T_c = 25^\circ\text{C}$ )	$V_{GT}$	$T_J = 25^\circ\text{C}$	0.4	0.60	0.8	V
		$T_J = -40^\circ\text{C}$	0.5	0.75	1.0	V
Gate Non-Trigger Voltage (Continuous dc) (Note 4) ( $V_{AK} = 12$ V, $R_L = 100$ ( $V_{AK} = 12$ V, $R_L = 100$ , $T_J = 110^\circ\text{C}$ ), $T_J = 110^\circ\text{C}$ )	$V_{GD}$	0.2	–	–	V	
Latching Current ( $V_{AK} = 12$ V, $I_G = 20$ mA, $R_{GK} = 1 \text{ k}\Omega$ )	$I_L$	$T_J = 25^\circ\text{C}$	–	0.20	5.0	mA
		$T_J = -40^\circ\text{C}$	–	0.35	7.0	mA
Holding Current ( $V_D = 12$ Vdc) (Initiating Current = 20 mA, $R_{GK} = 1 \text{ k}\Omega$ )	$I_H$	$T_J = 25^\circ\text{C}$	–	0.19	3.0	mA
		$T_J = -40^\circ\text{C}$	–	0.33	6.0	mA
		$T_J = +110^\circ\text{C}$	–	0.07	2.0	mA

**Dynamic Characteristics**

Characteristic	Symbol	Min	Typ	Max	Unit
Critical Rate-of-Rise of Off State Voltage ( $V_{AK}$ = Rated $V_{DRM}$ , Exponential Waveform, $R_{GK} = 1k\Omega, T_J = 110^\circ C$ )	dv/dt	-	8.0	-	V/ $\mu s$

- 3. Pulse Test: Pulse Width  $\leq 2.0$  ms, Duty Cycle  $\leq 2\%$ .
- 4.  $R_{GK}$  is not included in measurement.

**Voltage Current Characteristic of SCR**

Symbol	Parameter
$V_{DRM}$	Peak Repetitive Forward Off State Voltage
$I_{DRM}$	Peak Forward Blocking Current
$V_{RRM}$	Peak Repetitive Reverse Off State Voltage
$I_{RRM}$	Peak Reverse Blocking Current
$V_{TM}$	Maximum On State Voltage
$I_H$	Holding Current

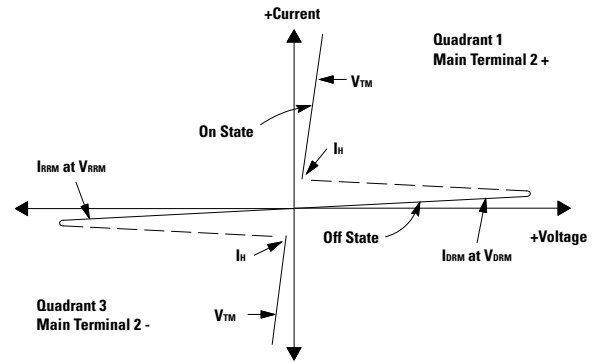

**Figure 1. Average Current Derating**

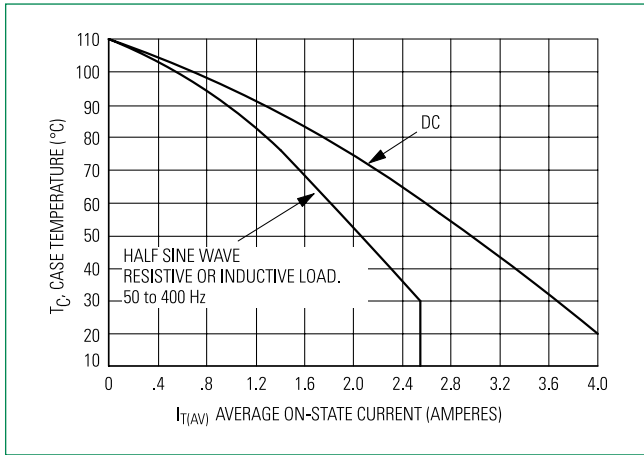

**Figure 2. Maximum On-State Power Dissipation**

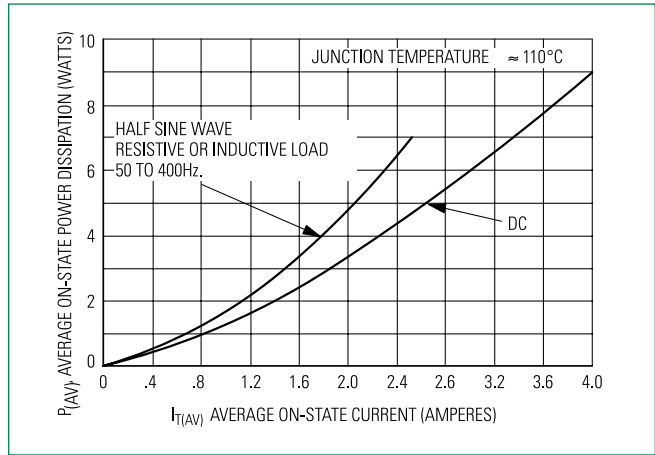

**Figure 3. Typical Gate Trigger Current vs. Junction Temp**

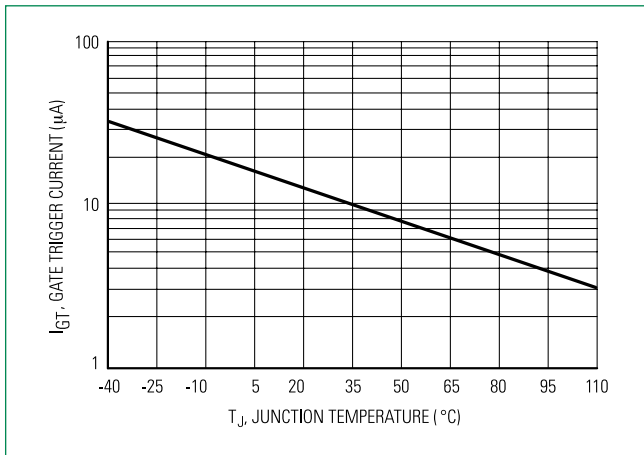

**Figure 4. Typical Holding Current vs. Junction Temp**

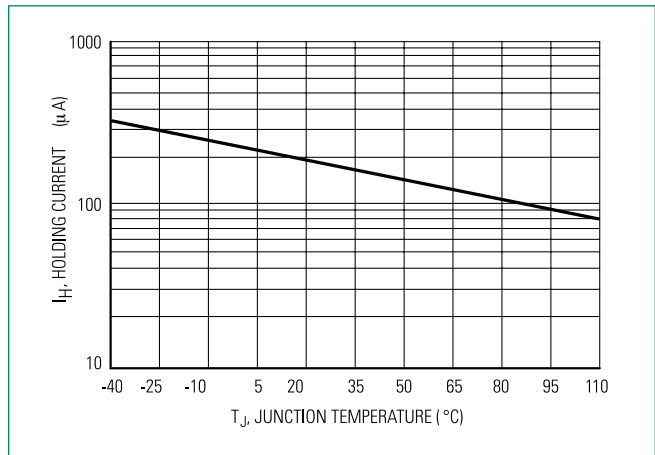

**Figure 5. Typical Gate Trigger Voltage vs. Junction Temp**

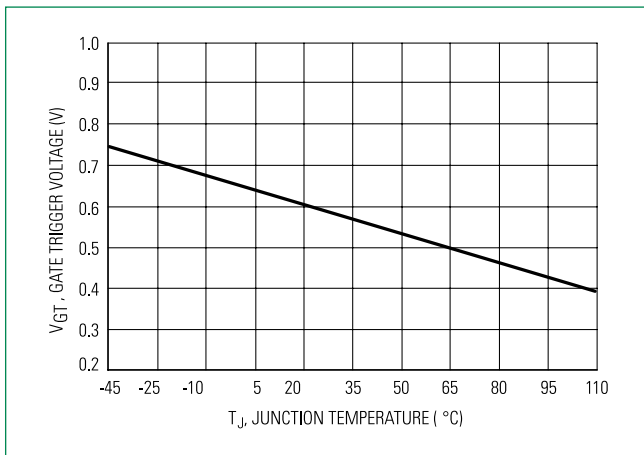

**Figure 5. Typical Latching Current vs. Junction Temp**

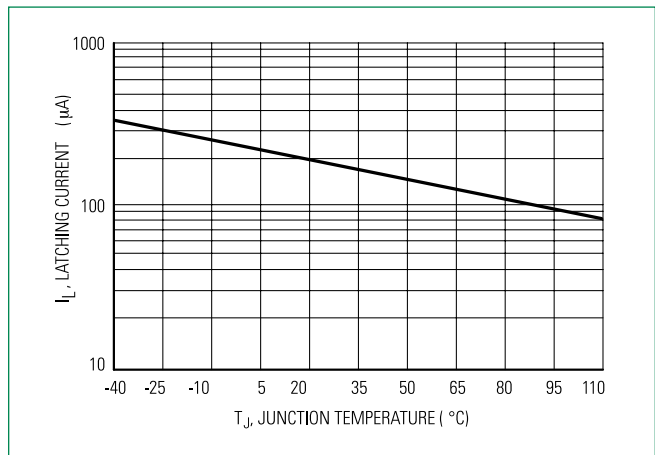

**Dimensions**

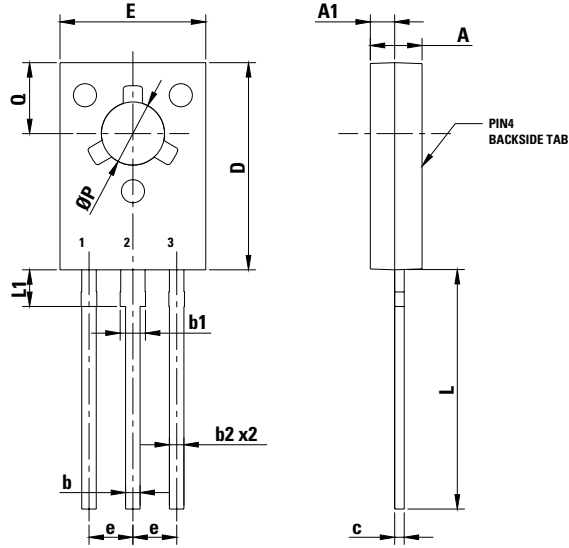

**Part Marking System**

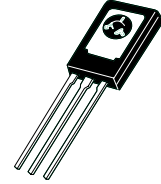

**TO-225A A**  
**Case 07 7**  
**Style 2**

- 1. Cathode
- 2. Anode
- 3. Gate

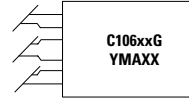

- Y =Year
- M =Month
- A =Assembly Site
- XX =Lot Serial Code
- C106xx =Device Code
- xx =B, D, D1, M, M1
- G =Pb-Free Package

Dim	Inches		Millimeters	
	Min	Max	Min	Max
A	0.102	0.110	2.60	2.80
A1	0.047	0.055	1.20	1.40
b	0.028	0.034	0.70	0.86
b2	0.028	0.034	0.70	0.86
c	0.019	0.022	0.49	0.57
D	0.417	0.449	10.60	11.40
E	0.291	0.323	7.40	8.20
e	0.090 TYP		2.29 TYP	
L	0.551	0.630	14.00	16.00
L1	0.091	0.106	2.30	2.70
P	0.118	0.134	3.00	3.40
Q	0.142	0.157	3.60	4.00
b1	0.047	0.055	1.2	1.4

- 1. DIMENSIONING AND TOLERANCING PER ANSI Y14.5M, 1982.
- 2. CONTROLLING DIMENSION: INCH.
- 3. 077-01 THRU -08 OBSOLETE, NEW STANDARD 077-09.

Pin Assignment	
1	Cathode
2	Anode
3	Gate

**Ordering Information**

Device	Package	Shipping
C106BG	TO225AA (Pb-Free)	2500 Units/Box
C106DG		
C106D1G*		
C106MG		
C106M1G*		
C106MTG		60 Units/Tube 1920 Units/Box

\*D1 signifies European equivalent for D suffix and M1 signifies European equivalent for M suffix.