



# Bridgelux® V10 F90 Array Series

Product Data Sheet DS446



# Introduction

V Series



The V Series™ LED Array products deliver high quality light in a compact and cost-effective solid-state lighting package. These chip on board (COB) arrays can be efficiently driven up to two times the nominal drive current, enabling design flexibility not previously possible. These high flux density light sources are designed to support a wide range of high quality, low cost directional luminaires and replacement lamps for both interior and exterior commercial and residential applications.

The F90 V Series COB is a high efficacy product that uses narrow band red phosphor to significantly improve the spectrum efficacy. The improved spectrum efficacy results in the 90 CRI product of the F90 Series delivering better or equivalent efficacy as that of our traditional 80 CRI V Series product.

The V10 LED Array is available in a variety of electrical, CCT, and CRI combinations providing substantial design flexibility and energy efficiency advantages.

Lighting system designs incorporating these LED arrays deliver increased system level efficacy and a longer service life. Typical applications include replacement lamps and task, accent, spot, track, wide area, security, wall packs and down lights.

## Features

- Efficacy of 182 lm/W typical, 3000K 90 CRI
- Wide selection of CCT options (2700K-5000K) with minimum 90 CRI options
- Uniform high-quality illumination
- 2 and 3 SDCM binning options (2700K – 4000K)
- 3 and 4 SDCM binning options (5000K)
- Forward voltage bin codes and backside marking
- Instant light with unlimited dimming
- 5-Year warranty

## Benefits

- Enables high efficiency lighting systems and lower operating costs
- Supports the trend toward luminaire miniaturization and delivers enhanced optical control
- Design flexibility for a broad range of lighting applications
- Clean white light without pixelation
- Uniform consistent white light
- Design flexibility for multi-source applications
- Easy to use with daylight and motion sensors to increase energy savings
- Design with confidence



# Contents

Product Feature Map	2
Product Nomenclature	2
Product Selection Guide	3
European Product Registry for Energy Labeling	5
Performance at Commonly Used Drive Currents	6
Electrical Characteristics	9
Eye Safety	10
Absolute Maximum Ratings	11
Performance Curves	13
Typical Radiation Pattern	15
Typical Color Spectrum	16
Mechanical Dimensions	17
Color Binning Information	18
Packaging and Labeling	19
Design Resources	21
Precautions	21
Disclaimers	21
About Bridgelux	22

# Product Feature Map

Bridgelux arrays are fully engineered devices that provide consistent thermal and optical performance on an engineered mechanical platform. The V Series arrays are the most compact chip-on-board devices across all of

Bridgelux's LED Array products. The arrays incorporate several features to simplify design integration and assembly. Please visit [www.bridgelux.com](http://www.bridgelux.com) for more information on the V Series family of products.

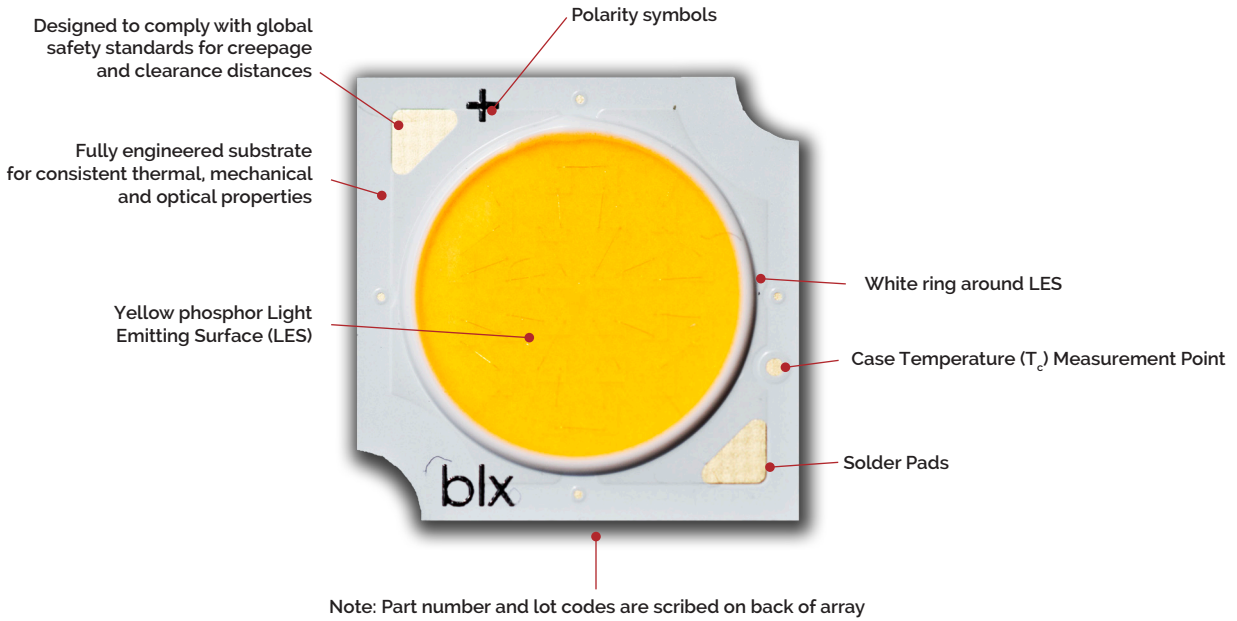

## Product Nomenclature

The part number designation for Bridgelux V Series LED arrays is explained as follows:

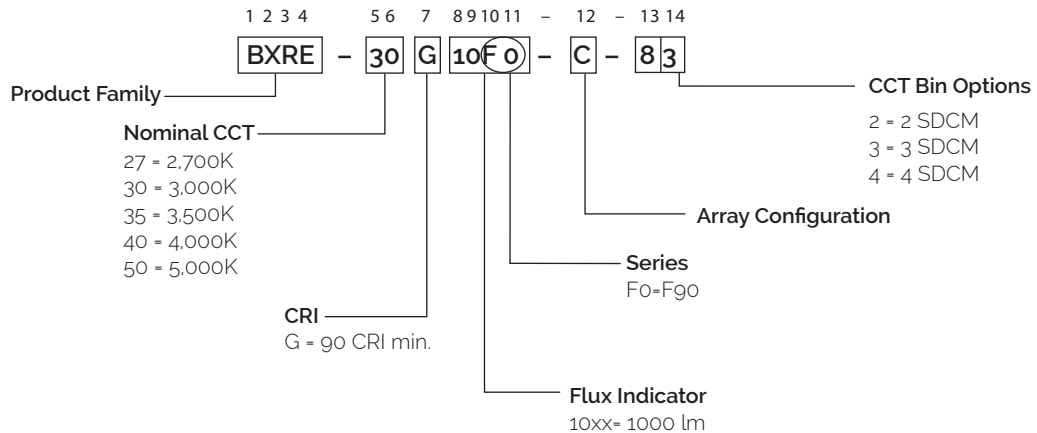

# Product Selection Guide

The following product configurations are available:

**Table 1:** Selection Guide, Pulsed Measurement Data ( $T_j = T_c = 25^\circ\text{C}$ )

Part Number	Nominal CCT <sup>1</sup> (K)	CRI <sup>2</sup>	Nominal Drive Current <sup>3</sup> (mA)	Typical Pulsed Flux <sup>4,5,6</sup> $T_c = 25^\circ\text{C}$ (lm)	Minimum Pulsed Flux <sup>6,7</sup> $T_c = 25^\circ\text{C}$ (lm)	Typical $V_f$ (V)	Typical Power (W)	Typical Efficacy (lm/W)
BXRE-27G10F0-A-8x	2700	90	300	1834	1651	34.5	10.3	177
BXRE-27G10F0-B-8x	2700	90	200	1218	1096	34.1	6.8	178
BXRE-27G10F0-C-8x	2700	90	300	1682	1513	31.6	9.5	177
BXRE-30G10F0-A-8x	3000	90	300	1872	1685	34.5	10.3	181
BXRE-30G10F0-B-8x	3000	90	200	1243	1119	34.1	6.8	182
BXRE-30G10F0-C-8x	3000	90	300	1716	1544	31.6	9.5	181
BXRE-35G10F0-A-8x	3500	90	300	1891	1702	34.5	10.3	183
BXRE-35G10F0-B-8x	3500	90	200	1255	1130	34.1	6.8	184
BXRE-35G10F0-C-8x	3500	90	300	1733	1560	31.6	9.5	183
BXRE-40G10F0-A-8x	4000	90	300	1909	1718	34.5	10.3	185
BXRE-40G10F0-B-8x	4000	90	200	1268	1141	34.1	6.8	186
BXRE-40G10F0-C-8x	4000	90	300	1750	1575	31.6	9.5	185
BXRE-50G10F0-A-8x	5000	90	300	1853	1668	34.5	10.3	179
BXRE-50G10F0-B-8x	5000	90	200	1231	1108	34.1	6.8	180
BXRE-50G10F0-C-8x	5000	90	300	1699	1529	31.6	9.5	179

Notes for Table 1:

- Nominal CCT as defined by ANSI C78.377-2011.
- CRI values are minimums and tested at  $T_j = T_c = 85^\circ\text{C}$ . Minimum R<sub>g</sub> value for 90 CRI products is 50. Bridgelux maintains a  $\pm 3$  tolerance on CRI and R<sub>g</sub> values.
- Drive current is referred to as nominal drive current.
- Products tested under pulsed condition (10ms pulse width) at nominal test current where  $T_j$  (junction temperature) =  $T_c$  (case temperature) =  $25^\circ\text{C}$ .
- Typical performance values are provided as a reference only and are not a guarantee of performance.
- Bridgelux maintains a  $\pm 7\%$  tolerance on flux measurements.
- Minimum flux values at the nominal test current are guaranteed by 100% test.

# Product Selection Guide

**Table 2:** Selection Guide, Stabilized DC Performance ( $T_c = 85^\circ\text{C}$ )<sup>4,5</sup>

Part Number	Nominal CCT <sup>1</sup> (K)	CRI <sup>2</sup>	Nominal Drive Current <sup>3</sup> (mA)	Typical DC Flux <sup>4,5</sup> $T_c = 85^\circ\text{C}$ (lm)	Minimum DC Flux <sup>6</sup> $T_c = 85^\circ\text{C}$ (lm)	Typical $V_f$ (V)	Typical Power (W)	Typical Efficacy (lm/W)
BXRE-27G10Fo-A-8x	2700	90	300	1688	1519	33.7	10.1	167
BXRE-27G10Fo-B-8x	2700	90	200	1121	1009	33.4	6.7	168
BXRE-27G10Fo-C-8x	2700	90	300	1547	1392	30.9	9.3	167
BXRE-30G10Fo-A-8x	3000	90	300	1722	1550	33.7	10.1	170
BXRE-30G10Fo-B-8x	3000	90	200	1144	1029	33.4	6.7	171
BXRE-30G10Fo-C-8x	3000	90	300	1579	1421	30.9	9.3	170
BXRE-35G10Fo-A-8x	3500	90	300	1739	1565	33.7	10.1	172
BXRE-35G10Fo-B-8x	3500	90	200	1155	1040	33.4	6.7	173
BXRE-35G10Fo-C-8x	3500	90	300	1594	1435	30.9	9.3	172
BXRE-40G10Fo-A-8x	4000	90	300	1757	1581	33.7	10.1	174
BXRE-40G10Fo-B-8x	4000	90	200	1166	1050	33.4	6.7	175
BXRE-40G10Fo-C-8x	4000	90	300	1610	1449	30.9	9.3	174
BXRE-50G10Fo-A-8x	5000	90	300	1705	1534	33.7	10.1	168
BXRE-50G10Fo-B-8x	5000	90	200	1132	1019	33.4	6.7	169
BXRE-50G10Fo-C-8x	5000	90	300	1563	1407	30.9	9.3	168

Notes for Table 2:

- Nominal CCT as defined by ANSI C78.377-2011.
- CRI values are minimums and tested at  $T_j = T_c = 85^\circ\text{C}$ . Minimum R<sub>g</sub> value for 90 CRI products is 50.
- Drive current is referred to as nominal drive current.
- Typical stabilized DC performance values are provided as reference only and are not a guarantee of performance.
- Typical performance is estimated based on operation under DC (direct current) with LED array mounted onto a heat sink with thermal interface material and the case temperature maintained at  $85^\circ\text{C}$ . Based on Bridgelux test setup, values may vary depending on the thermal design of the luminaire and/or the exposed environment to which the product is subjected.
- Minimum flux values at elevated temperatures are provided for reference only and are not guaranteed by 100% production testing. Based on Bridgelux test setup, values may vary depending on the thermal design of the luminaire and/or the exposed environment to which the product is subjected.

# European Product Registry for Energy Labeling

The European Product Registry for Energy Labeling (EPREL) is defined in the EU Regulation 2017/1369 to provide important energy efficiency information to consumers. Together with Energy Labeling Regulation ELR (EU) 2019/2015 which was amended by regulation (EU) 2021/340 for energy labelling of light sources, manufacturers are required to declare an energy class based on key technical specifications from each of their product and register it in an open data base managed by EPREL. It is now a legal requirement for a vendor of light sources to upload information about their products into the EPREL database before placing these products on the market in the EU.

Table 3 below provides a list of part numbers that are in compliance with ELR and are currently listed in the EPREL database.

At Bridgelux, we are fully committed to supplying products that are compliant with pertinent laws, rules, and obligation imposed by relevant government bodies including the European Energy Labeling regulation. Customers can use these products with full confidence for any projects that fall under the ELR.

**Table 3:** Part numbers registered in European Product Registry for Energy Labeling

PART NUMBER <sup>1</sup>	CCT (K)	CRI	Current <sup>2</sup> (mA)	Vf (V)	Useful flux <sup>3</sup> ( $\Phi_{use}$ ) at 85C (lm)	Power (W)	Efficacy (lm/W)	Energy efficiency class <sup>4</sup>	Registration No	URL to Product Information Sheet in EPREL Database
BXRE-27G10F0-A-83	2700	90	720	38.0	3580	274	131	E	1168451	<a href="https://eprelec.europa.eu/qr/1168451">https://eprelec.europa.eu/qr/1168451</a>
BXRE-27G10F0-B-83	2700	90	540	38.0	2651	20.5	129	E	1168452	<a href="https://eprelec.europa.eu/qr/1168452">https://eprelec.europa.eu/qr/1168452</a>
BXRE-27G10F0-C-83	2700	90	720	34.8	3282	25.1	131	E	1168453	<a href="https://eprelec.europa.eu/qr/1168453">https://eprelec.europa.eu/qr/1168453</a>
BXRE-30G10F0-A-83	3000	90	720	38.0	3653	274	134	E	1168458	<a href="https://eprelec.europa.eu/qr/1168458">https://eprelec.europa.eu/qr/1168458</a>
BXRE-30G10F0-B-83	3000	90	540	38.0	2705	20.5	132	E	1168459	<a href="https://eprelec.europa.eu/qr/1168459">https://eprelec.europa.eu/qr/1168459</a>
BXRE-30G10F0-C-83	3000	90	720	34.8	3349	25.1	134	E	878975	<a href="https://eprelec.europa.eu/qr/878975">https://eprelec.europa.eu/qr/878975</a>
BXRE-35G10F0-A-83	3500	90	720	38.0	3690	274	135	E	1168463	<a href="https://eprelec.europa.eu/qr/1168463">https://eprelec.europa.eu/qr/1168463</a>
BXRE-35G10F0-B-83	3500	90	540	38.0	2732	20.5	133	E	1168464	<a href="https://eprelec.europa.eu/qr/1168464">https://eprelec.europa.eu/qr/1168464</a>
BXRE-35G10F0-C-83	3500	90	720	34.8	3382	25.1	135	E	1168465	<a href="https://eprelec.europa.eu/qr/1168465">https://eprelec.europa.eu/qr/1168465</a>
BXRE-40G10F0-A-83	4000	90	720	38.0	3726	274	136	E	1168470	<a href="https://eprelec.europa.eu/qr/1168470">https://eprelec.europa.eu/qr/1168470</a>
BXRE-40G10F0-B-83	4000	90	540	38.0	2759	20.5	134	E	1168471	<a href="https://eprelec.europa.eu/qr/1168471">https://eprelec.europa.eu/qr/1168471</a>
BXRE-40G10F0-C-83	4000	90	720	34.8	3416	25.1	136	E	1168472	<a href="https://eprelec.europa.eu/qr/1168472">https://eprelec.europa.eu/qr/1168472</a>
BXRE-50G10F0-A-84	5000	90	720	38.0	3617	274	132	E	1168477	<a href="https://eprelec.europa.eu/qr/1168477">https://eprelec.europa.eu/qr/1168477</a>
BXRE-50G10F0-B-84	5000	90	540	38.0	2678	20.5	131	E	1168478	<a href="https://eprelec.europa.eu/qr/1168478">https://eprelec.europa.eu/qr/1168478</a>
BXRE-50G10F0-C-84	5000	90	720	34.8	3315	25.1	132	E	1168479	<a href="https://eprelec.europa.eu/qr/1168479">https://eprelec.europa.eu/qr/1168479</a>

Notes for Table 3:

1. All device listed here must be disposed as e-waste upon its end of life according to local country guideline in each country.
2. For information on performance values at alternative drive conditions, please refer to the Product Selection Guide, Absolute Maximum Rating Table and Performance Curves in this data sheet.
3. For a definition of useful luminous flux ( $\Phi_{use}$ ), please see the ELR regulations at <https://tinyurl.com/4b6zvt4m>.
4. EPREL requires an arrow symbol containing the letter of the energy efficiency class to be displayed, on technical promotional material. Refer to this energy efficiency class column for specific energy efficiency class on each part number.

# Performance at Commonly Used Drive Currents

V Series LED arrays are tested to the specifications shown using the nominal drive currents in Table 1. V Series LED Arrays may also be driven at other drive currents dependent on specific application design requirements. The performance at any drive current can be derived from the current vs. voltage characteristics shown in Figures 1, 2 & 3 and the flux vs. current characteristics shown in Figures 4, 5 & 6. The performance at commonly used drive currents is summarized in Table 4.

**Table 4:** Product Performance at Commonly Used Drive Currents

Part Number	CRI	Drive Current <sup>1</sup> (mA)	Typical V <sub>f</sub> T <sub>c</sub> = 25°C (V)	Typical Power T <sub>c</sub> = 25°C (W)	Typical Flux <sup>2</sup> T <sub>c</sub> = 25°C (lm)	Typical DC Flux <sup>3</sup> T <sub>c</sub> = 85°C (lm)	Typical Efficacy T <sub>c</sub> = 25°C (lm/W)
BXRE-27G10F0-A-8x	90	150	33.1	5.0	940	886	189
		225	33.8	7.6	1396	1300	183
		<b>300</b>	<b>34.5</b>	<b>10.3</b>	<b>1834</b>	<b>1688</b>	<b>177</b>
		360	35.0	12.6	2189	1994	174
		600	36.9	22.1	3512	3061	159
		720	37.7	27.2	4130	3516	152
BXRE-27G10F0-B-8x	90	100	32.9	3.3	620	584	188
		150	33.6	5.0	922	859	183
		<b>200</b>	<b>34.1</b>	<b>6.8</b>	<b>1218</b>	<b>1121</b>	<b>178</b>
		270	34.9	9.4	1622	1465	172
		400	36.3	14.5	2337	2038	161
		540	37.7	20.3	3059	2556	150
BXRE-27G10F0-C-8x	90	150	30.4	4.6	858	809	188
		225	31.0	7.0	1275	1187	183
		<b>300</b>	<b>31.6</b>	<b>9.5</b>	<b>1682</b>	<b>1547</b>	<b>177</b>
		360	32.1	11.5	2000	1821	173
		600	33.8	20.3	3207	2796	158
		720	34.6	24.9	3773	3212	152
BXRE-30G10F0-A-8x	90	150	33.1	5.0	959	904	193
		225	33.8	7.6	1424	1327	187
		<b>300</b>	<b>34.5</b>	<b>10.3</b>	<b>1872</b>	<b>1722</b>	<b>181</b>
		360	35.0	12.6	2234	2034	177
		600	36.9	22.1	3583	3124	162
		720	37.7	27.2	4215	3588	155
BXRE-30G10F0-B-8x	90	100	32.9	3.3	633	596	192
		150	33.6	5.0	941	876	187
		<b>200</b>	<b>34.1</b>	<b>6.8</b>	<b>1243</b>	<b>1144</b>	<b>182</b>
		270	34.9	9.4	1655	1495	175
		400	36.3	14.5	2385	2079	164
		540	37.7	20.3	3122	2608	153
BXRE-30G10F0-C-8x	90	150	30.4	4.6	876	825	192
		225	31.0	7.0	1301	1212	187
		<b>300</b>	<b>31.6</b>	<b>9.5</b>	<b>1716</b>	<b>1579</b>	<b>181</b>
		360	32.1	11.5	2040	1858	177
		600	33.8	20.3	3273	2853	161
		720	34.6	24.9	3849	3277	155

Notes for Table 4:

1. Alternate drive currents in Table 4 are provided for reference only and are not a guarantee of performance.
2. Bridgelux maintains a ± 7% tolerance on flux measurements.
3. Typical stabilized DC performance values are provided as reference only and are not a guarantee of performance.



# Performance at Commonly Used Drive Currents

**Table 4:** Product Performance at Commonly Used Drive Currents (Continued)

Part Number	CRI	Drive Current <sup>1</sup> (mA)	Typical $V_f$ $T_c = 25^\circ\text{C}$ (V)	Typical Power $T_c = 25^\circ\text{C}$ (W)	Typical Flux <sup>2</sup> $T_c = 25^\circ\text{C}$ (lm)	Typical DC Flux <sup>3</sup> $T_c = 85^\circ\text{C}$ (lm)	Typical Efficacy $T_c = 25^\circ\text{C}$ (lm/W)
BXRE-35G10Fo-A-8x	90	150	33.1	5.0	969	913	195
		225	33.8	7.6	1439	1340	189
		<b>300</b>	<b>34.5</b>	<b>10.3</b>	<b>1891</b>	<b>1739</b>	<b>183</b>
		360	35.0	12.6	2256	2055	179
		600	36.9	22.1	3619	3155	164
		720	37.7	27.2	4257	3624	157
BXRE-35G10Fo-B-8x	90	100	32.9	3.3	639	602	194
		150	33.6	5.0	950	885	189
		<b>200</b>	<b>34.1</b>	<b>6.8</b>	<b>1255</b>	<b>1155</b>	<b>184</b>
		270	34.9	9.4	1671	1510	177
		400	36.3	14.5	2409	2100	166
		540	37.7	20.3	3153	2634	155
BXRE-35G10Fo-C-8x	90	150	30.4	4.6	885	834	194
		225	31.0	7.0	1314	1224	188
		<b>300</b>	<b>31.6</b>	<b>9.5</b>	<b>1733</b>	<b>1594</b>	<b>183</b>
		360	32.1	11.5	2061	1877	179
		600	33.8	20.3	3305	2882	163
		720	34.6	24.9	3888	3310	156
BXRE-40G10Fo-A-8x	90	150	33.1	5.0	978	922	197
		225	33.8	7.6	1453	1353	191
		<b>300</b>	<b>34.5</b>	<b>10.3</b>	<b>1909</b>	<b>1757</b>	<b>185</b>
		360	35.0	12.6	2279	2075	181
		600	36.9	22.1	3655	3186	165
		720	37.7	27.2	4299	3660	158
BXRE-40G10Fo-B-8x	90	100	32.9	3.3	645	608	196
		150	33.6	5.0	960	894	191
		<b>200</b>	<b>34.1</b>	<b>6.8</b>	<b>1268</b>	<b>1166</b>	<b>186</b>
		270	34.9	9.4	1688	1525	179
		400	36.3	14.5	2433	2121	167
		540	37.7	20.3	3184	2660	156
BXRE-40G10Fo-C-8x	90	150	30.4	4.6	893	842	196
		225	31.0	7.0	1327	1236	190
		<b>300</b>	<b>31.6</b>	<b>9.5</b>	<b>1750</b>	<b>1610</b>	<b>185</b>
		360	32.1	11.5	2081	1895	180
		600	33.8	20.3	3338	2910	165
		720	34.6	24.9	3926	3343	158
BXRE-50G10Fo-A-8x	90	150	33.1	5.0	949	895	191
		225	33.8	7.6	1410	1313	185
		<b>300</b>	<b>34.5</b>	<b>10.3</b>	<b>1853</b>	<b>1705</b>	<b>179</b>
		360	35.0	12.6	2212	2014	176
		600	36.9	22.1	3547	3093	160
		720	37.7	27.2	4173	3552	154

Notes for Table 4:

1. Alternate drive currents in Table 4 are provided for reference only and are not a guarantee of performance.
2. Bridgelux maintains a  $\pm 7\%$  tolerance on flux measurements.
3. Typical stabilized DC performance values are provided as reference only and are not a guarantee of performance.

# Performance at Commonly Used Drive Currents

**Table 4:** Product Performance at Commonly Used Drive Currents (Continued)

Part Number	CRI	Drive Current <sup>1</sup> (mA)	Typical $V_f$ $T_c = 25^\circ\text{C}$ (V)	Typical Power $T_c = 25^\circ\text{C}$ (W)	Typical Flux <sup>2</sup> $T_c = 25^\circ\text{C}$ (lm)	Typical DC Flux <sup>3</sup> $T_c = 85^\circ\text{C}$ (lm)	Typical Efficacy $T_c = 25^\circ\text{C}$ (lm/W)
BXRE-50G10F0-B-8x	90	100	32.9	3.3	626	590	190
		150	33.6	5.0	932	868	185
		<b>200</b>	<b>34.1</b>	<b>6.8</b>	<b>1231</b>	<b>1132</b>	<b>180</b>
		270	34.9	9.4	1638	1480	174
		400	36.3	14.5	2361	2059	162
		540	37.7	20.3	3091	2582	152
BXRE-50G10F0-C-8x	90	150	30.4	4.6	867	817	190
		225	31.0	7.0	1288	1200	185
		<b>300</b>	<b>31.6</b>	<b>9.5</b>	<b>1699</b>	<b>1563</b>	<b>179</b>
		360	32.1	11.5	2020	1840	175
		600	33.8	20.3	3240	2825	160
		720	34.6	24.9	3811	3244	153

Notes for Table 4:

1. Alternate drive currents in Table 4 are provided for reference only and are not a guarantee of performance.
2. Bridgelux maintains a  $\pm 7\%$  tolerance on flux measurements.
3. Typical stabilized DC performance values are provided as reference only and are not a guarantee of performance.

# Electrical Characteristics

**Table 5:** Electrical Characteristics

Part Number	Drive Current (mA)	Forward Voltage Pulsed, $T_c = 25^\circ\text{C}$ (V) <sup>1, 2, 3, 8</sup>			Typical Coefficient of Forward Voltage <sup>4</sup> $\Delta V_f / \Delta T_c$ (mV/ $^\circ\text{C}$ )	Typical Thermal Resistance Junction to Case <sup>5,6</sup> $R_{j-c}$ ( $^\circ\text{C}/\text{W}$ )	Driver Selection Voltages <sup>7</sup> (V)	
		Minimum	Typical	Maximum			$V_f$ Min. Hot $T_c = 95^\circ\text{C}$ (V)	$V_f$ Max. Cold $T_c = -40^\circ\text{C}$ (V)
BXRE-xxx10F0-A-8x	300	32.4	34.5	36.5	-9.64	0.41	31.7	37.2
	720	35.5	37.7	40.0	-10.55	0.60	34.7	40.7
BXRE-xxx10F0-B-8x	200	32.1	34.1	36.2	-9.55	0.62	31.4	36.8
	540	35.4	37.7	39.9	-10.54	0.95	34.7	40.6
BXRE-xxx10F0-C-8x	300	29.7	31.6	33.5	-8.84	0.38	29.1	34.1
	720	32.5	34.6	36.7	-9.67	0.55	31.8	37.3

Notes for Table 5:

- Parts are tested in pulsed conditions.  $T_c = 25^\circ\text{C}$ . Pulse width is 10ms.
- Voltage minimum and maximum are provided for reference only and are not a guarantee of performance.
- Bridgelux maintains a tester tolerance of  $\pm 0.10\text{V}$  on forward voltage measurements.
- Typical coefficient of forward voltage tolerance is  $\pm 0.1\text{mV}$  for nominal current.
- Thermal resistance values are based from test data of a 3000K 90 CRI product.
- Thermal resistance value was calculated using total electrical input power; optical power was not subtracted from input power. The thermal interface material used during testing is not included in the thermal resistance value.
- $V_f$  min hot and max cold values are provided as reference only and are not guaranteed by test. These values are provided to aid in driver design and selection over the operating range of the product.
- This product has been designed and manufactured per IEC 62031:2018. This product has passed dielectric withstand voltage testing at 1140 V. The working voltage designated for the insulation is 70V d.c. The maximum allowable voltage across the array must be determined in the end product application.

# Eye Safety

**Table 6:** Eye Safety Risk Group (RG) Classifications

Part Number	Drive Current (mA)	CCT <sup>4</sup>		
		2700K/3000K	4000K <sup>2</sup>	5000K <sup>3</sup>
BXRE-xxx10F0-A-8x	495	RG1	RG1	RG1
	655	RG1	RG1	RG2
	720	RG1	RG2	RG2
BXRE-xxx10F0-B-8x	540	RG1	RG1	RG1
BXRE-xxx10F0-C-8x	550	RG1	RG1	RG1
	720	RG1	RG1	RG2

Notes for Table 6:

1. Eye safety classification for the use of Bridgelux V Series LED arrays is in accordance with specification IEC/TR 62778: Application of IEC 62471 for the assessment of blue light hazard to light sources and luminaires.
2. For products classified as RG2 at 4000K, Ethr= 1980 lx.
3. For products classified as RG2 at 5000K Ethr= 1530 lx.
4. Please contact your Bridgelux sales representative for Ethr values at specific drive currents and CCTs not listed.

# Absolute Maximum Ratings

**Table 7:** Maximum Ratings

Parameter	Maximum Rating		
LED Junction Temperature (T <sub>J</sub> )	150°C		
Storage Temperature <sup>1</sup>	-40°C to +95°C		
Operating Case Temperature <sup>2</sup> (T <sub>C</sub> )	95°C		
Soldering Temperature <sup>3</sup>	300°C or lower for a maximum of 6 seconds		
	BXRE-xxG10F0-A-8x	BXRE-xxG10F0-B-8x	BXRE-xxG10F0-C-8x
Maximum Drive Current <sup>4</sup>	720 mA at ≤85°C 540 mA at 95°C	540 mA at ≤85°C 405 mA at 95°C	720 mA at ≤85°C 540 mA at 95°C
Maximum Peak Pulsed Drive Current <sup>5</sup>	1030mA	770mA	1030mA
Maximum Reverse Voltage <sup>6</sup>	-60V	-60V	-55V

Notes for Table 7:

- The F90 product is robust enough to pass our internal humidity test but it is still more sensitive to moisture compared to our regular LED array product. The product needs to be stored in a dry environment. It is not recommended to use the product in a damp environment that is directly exposed to moisture.
- For IEC 62717 requirement, please consult your Bridgelux sales representative.
- Refer to Bridgelux Application Note AN101: Handling and Assembly of Bridgelux V Series LED Arrays
- Arrays may be driven at higher currents however lumen maintenance may be reduced and warranty will not apply.
- Bridgelux recommends a maximum duty cycle of 10% and pulse width of 20 ms when operating LED Arrays at maximum peak pulsed current specified. Maximum peak pulsed currents indicate values where LED Arrays can be driven without catastrophic failures.
- Light emitting diodes are not designed to be driven in reverse voltage and will not produce light under this condition. Maximum rating provided for reference only.

# Performance Curves

**Figure 1: V10A Drive Current vs. Voltage**

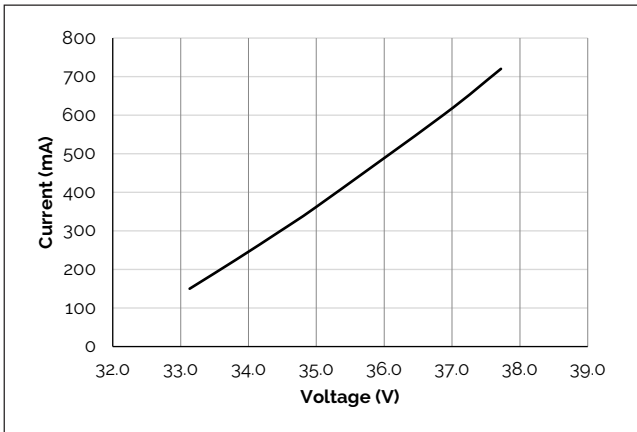

**Figure 2: V10B Drive Current vs. Voltage**

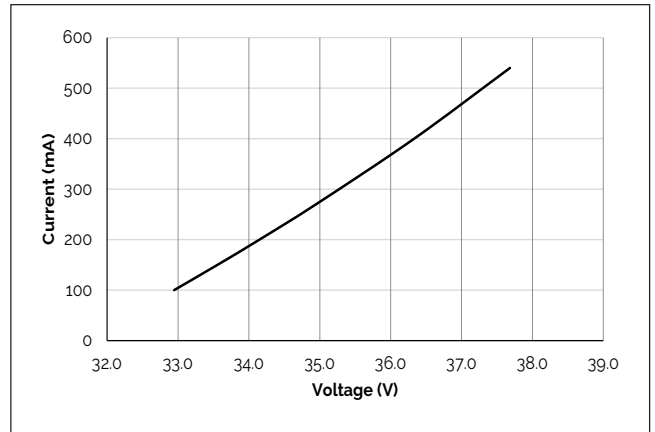

**Figure 3: V10C Drive Current vs. Voltage**

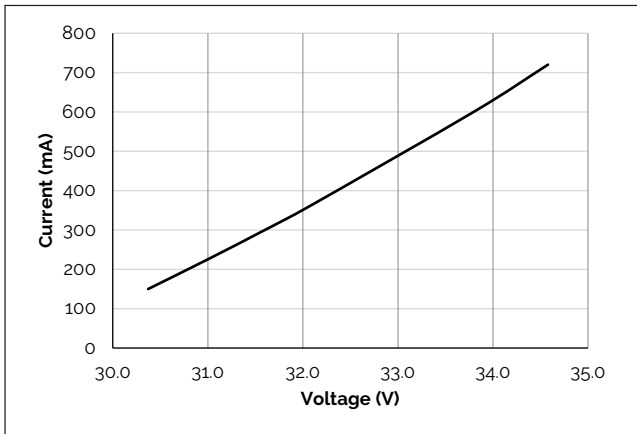

**Figure 4: V10A Typical Relative Flux vs. Current**

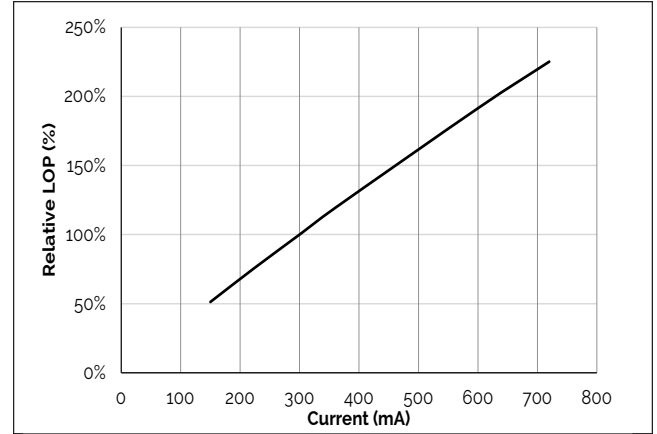

**Figure 5: V10B Typical Relative Flux vs. Current**

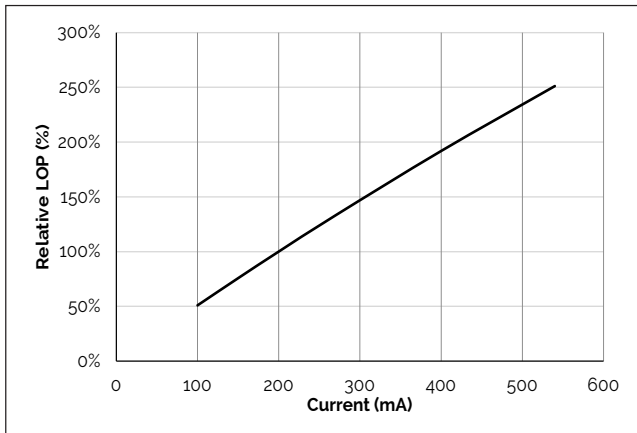

**Figure 6: V10C Typical Relative Flux vs. Current**

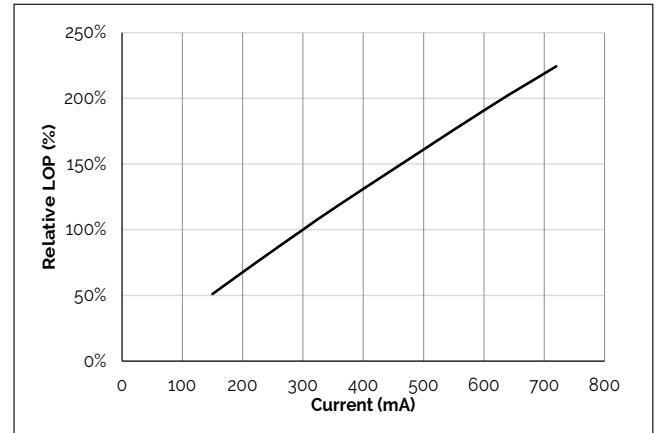

Notes for Figures 1-6:

1. Bridgelux does not recommend driving high power LEDs at low currents. Doing so may produce unpredictable results. Pulse width modulation (PWM) is recommended for dimming effects.
2. Products tested under pulsed condition (10ms pulse width) at nominal test current where  $T_j$  (junction temperature) =  $T_c$  (case temperature) = 25°C.

# Performance Curves

**Figure 7: Typical DC Flux vs. Case Temperature**

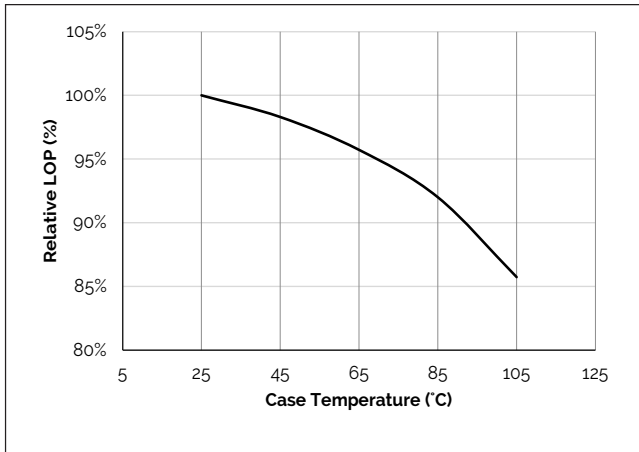

**Figure 8: Typical DC ccx Shift vs. Case Temperature**

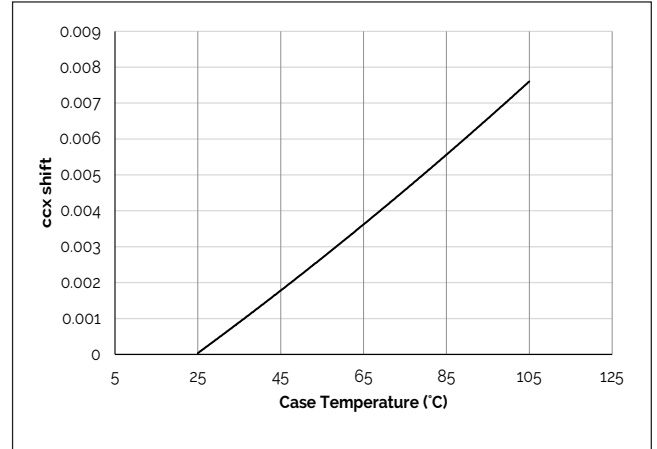

**Figure 9: Typical DC ccy Shift vs. Case Temperature**

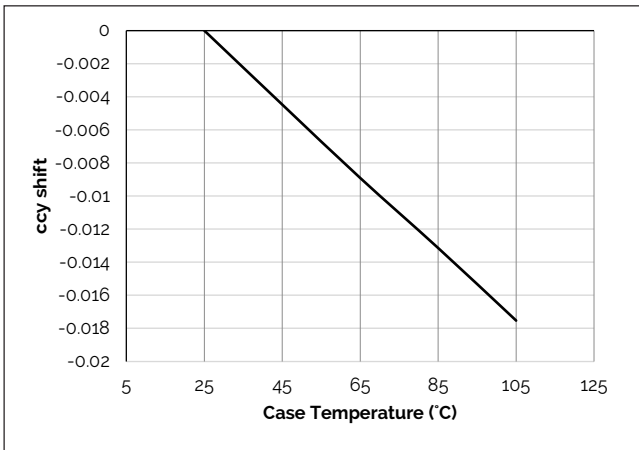

**Figure 10: V10A Drive Current vs. ccx Shift**

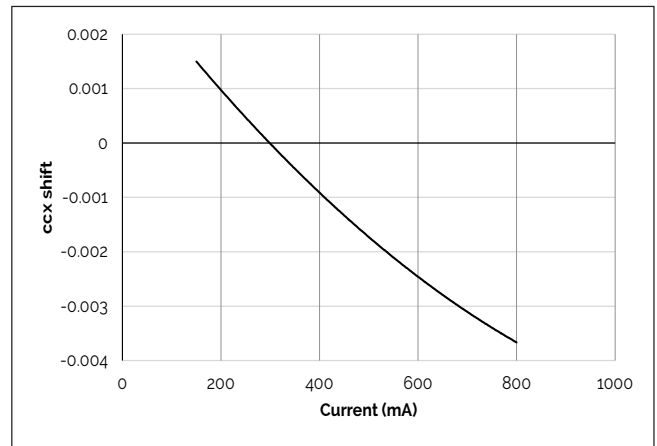

**Figure 11: V10A Drive Current vs. ccy Shift**

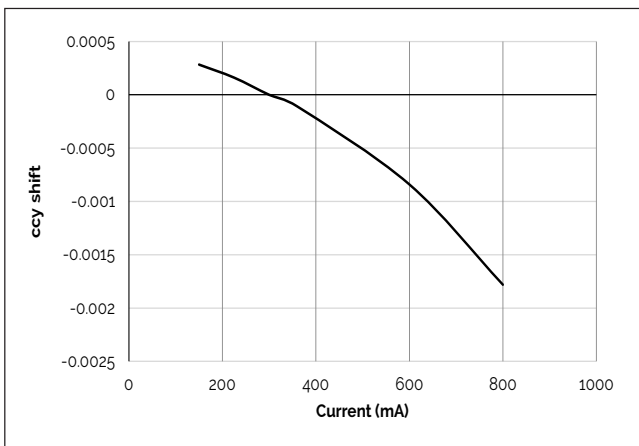

**Figure 12: V10B Drive Current vs. ccx Shift**

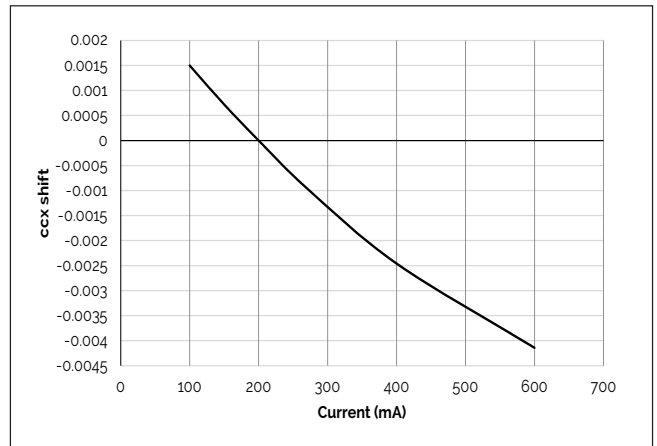

Note for Figures 7-12:

1. Characteristics shown for Warm White.

# Performance Curves

**Figure 13: V10B Drive Current vs. ccy Shift**

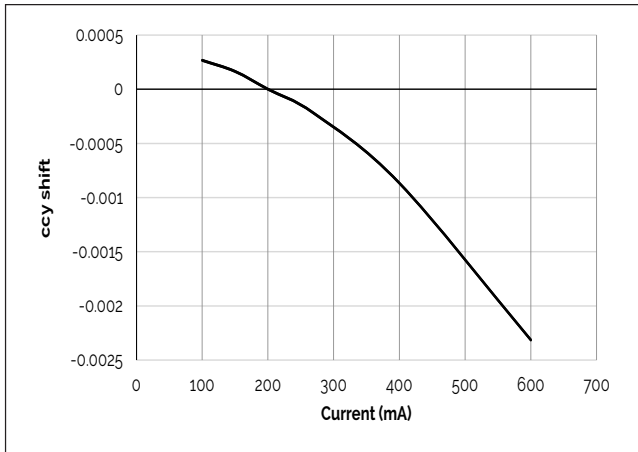

**Figure 14: V10C Drive Current vs. ccx Shift**

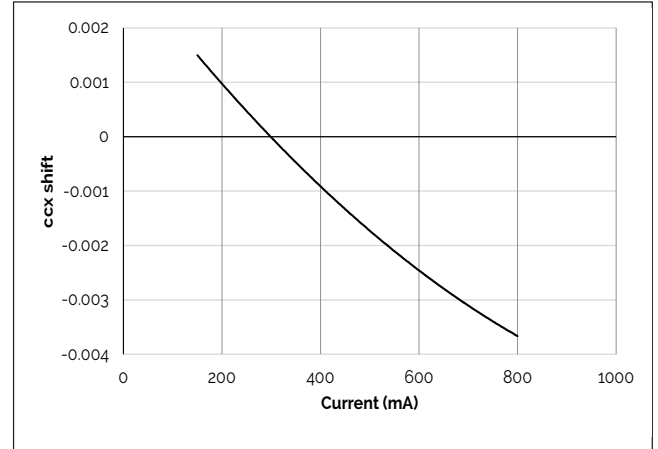

**Figure 15: V10C Drive Current vs. ccy Shift**

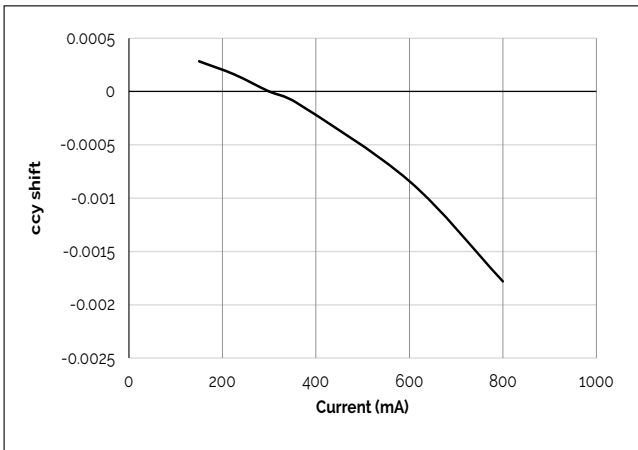

**Figure 16: Derating Curve**

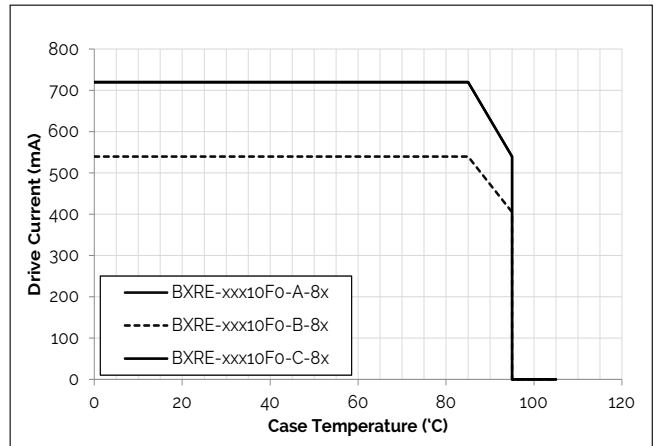



# Typical Radiation Pattern

Figure 17: Typical Spatial Radiation Pattern

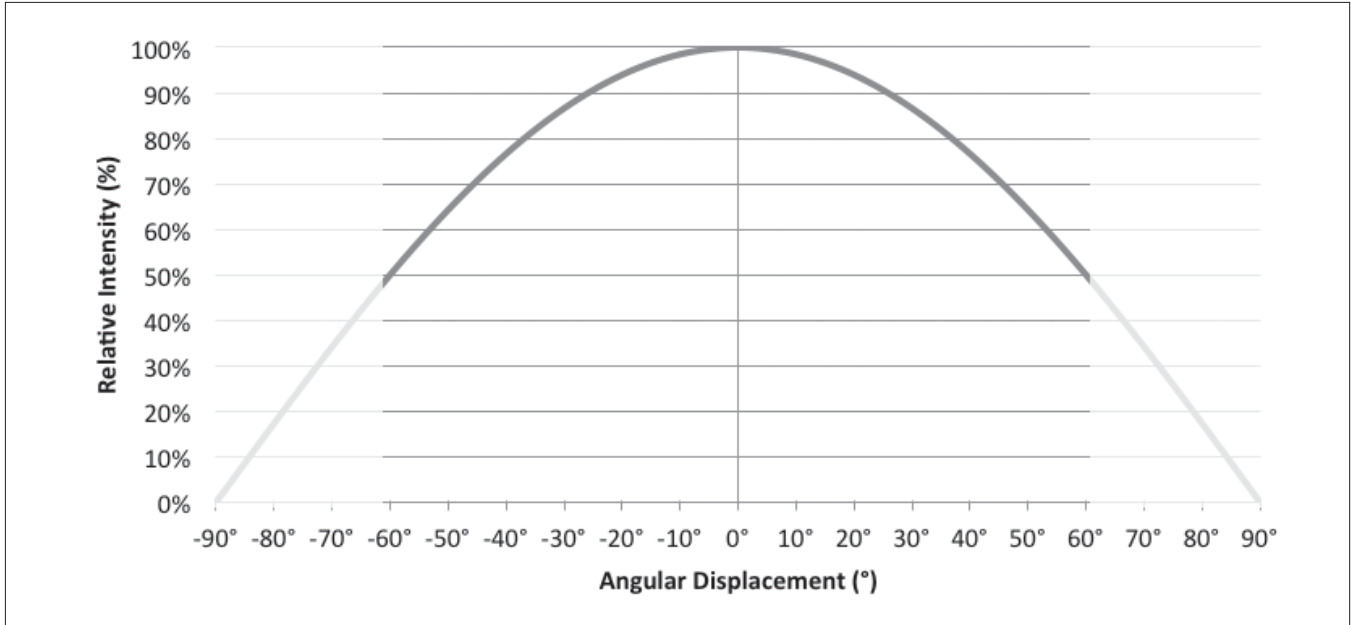

Notes for Figure 17:

1. Typical viewing angle is 120°.
2. The viewing angle is defined as the off axis angle from the centerline where intensity is ½ of the peak value.

Figure 18: Typical Polar Radiation Pattern

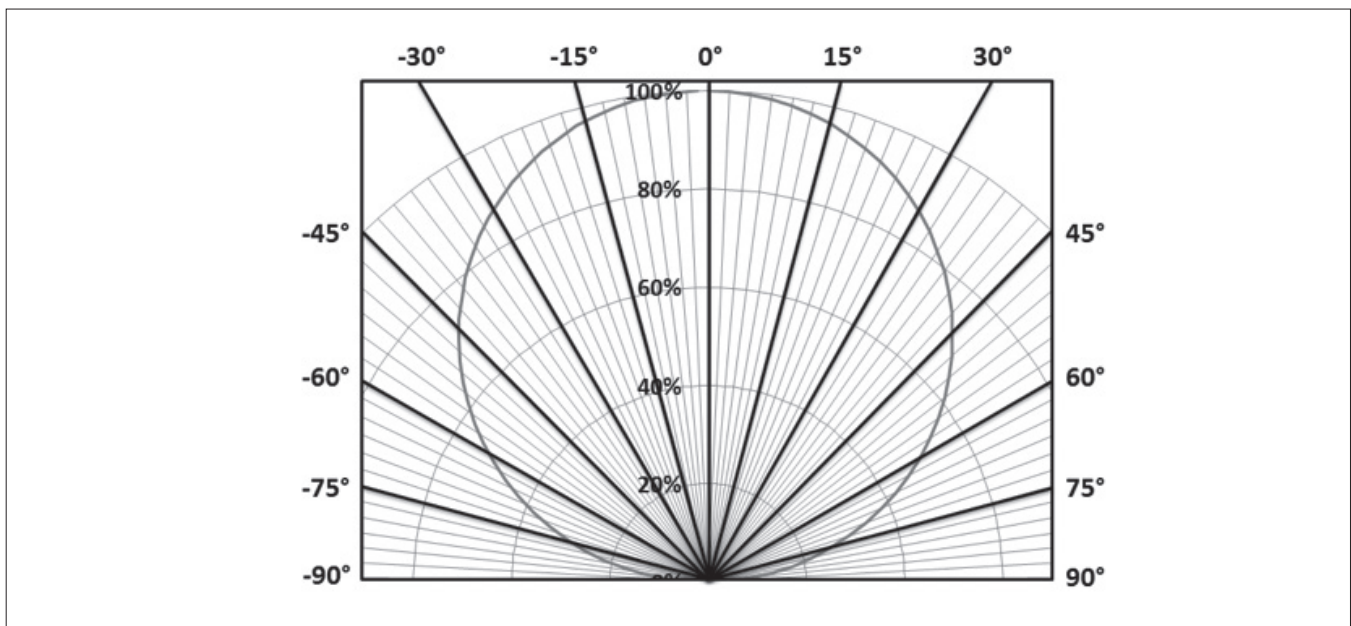

# Typical Color Spectrum

Figure 19: Typical Color Spectrum

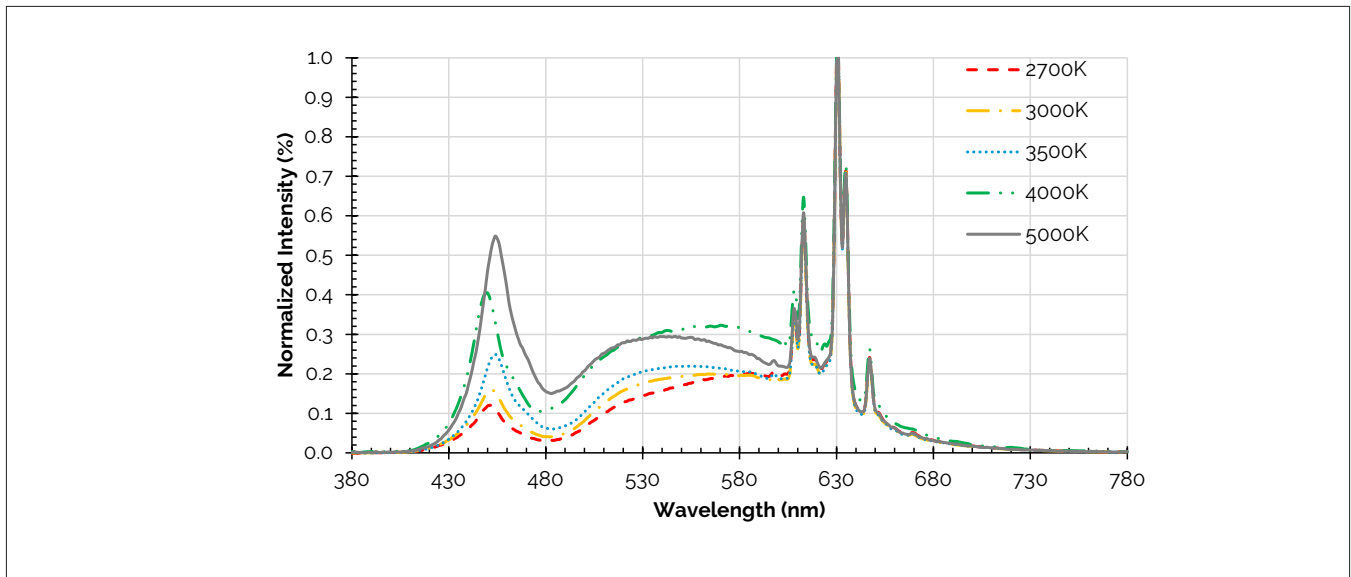

Notes for Figure 19:

1. Color spectra measured at nominal current for  $T_j = T_c = 85^\circ\text{C}$ .
2. Color spectra shown is 2700K and 90CRI.
3. Color spectra shown is 3000K and 90 CRI.
4. Color spectra shown is 3500K and 90 CRI.
5. Color spectra shown is 4000K and 90 CRI.
6. Color spectra shown is 5000K and 90 CRI.

# Mechanical Dimensions

Figure 20: V10 LED Array

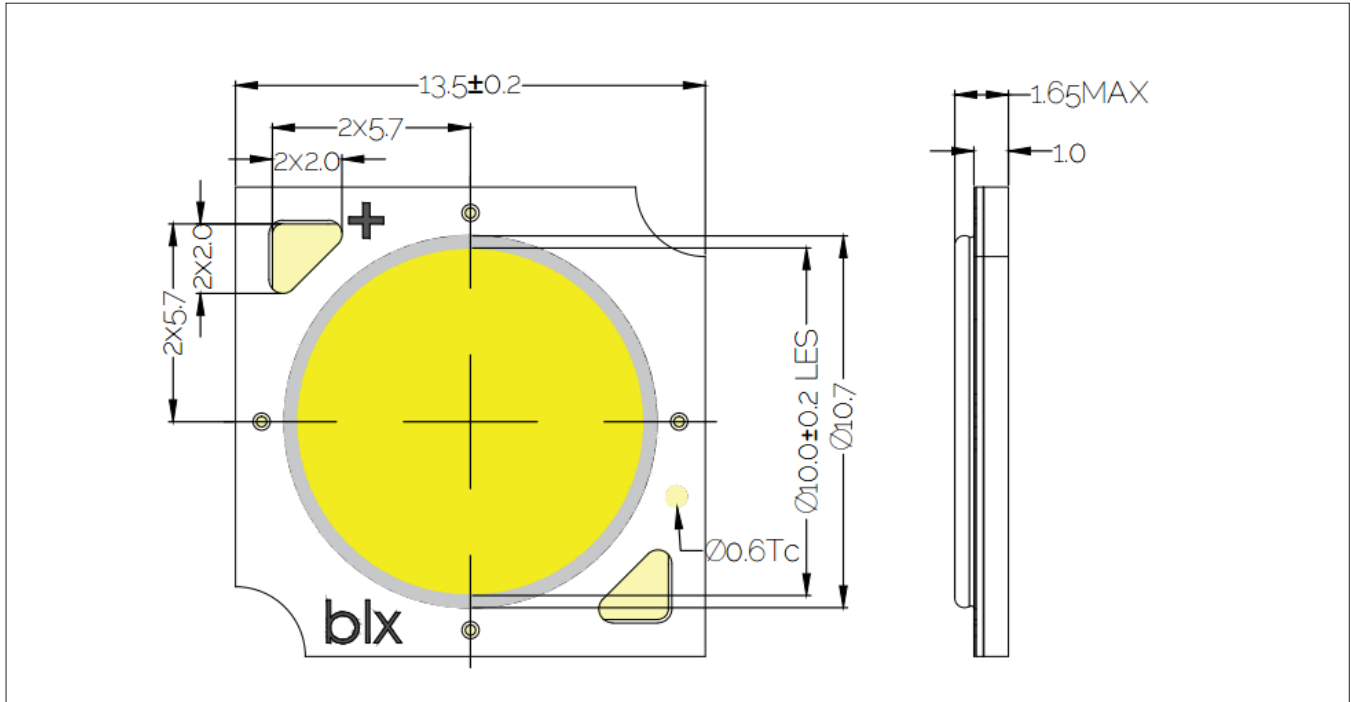

Notes for Figure 20:

1. Drawings are not to scale.
2. Drawing dimensions are in millimeters.
3. Unless otherwise specified, tolerances are  $\pm 0.1$ mm.
4. Solder pad labeled "\*" denotes positive contact.
5. Refer to Application Notes AN101 for product handling, mounting and heat sink recommendations.
6. The optical center of the LED Array is nominally defined by the mechanical center of the array to a tolerance of  $\pm 0.2$ mm.
7. Bridgelux maintains a flatness of  $0.10$ mm across the mounting surface of the array.

# Color Binning Information

**Figure 21: Warm and Neutral White Test Bins in xy Color Space**

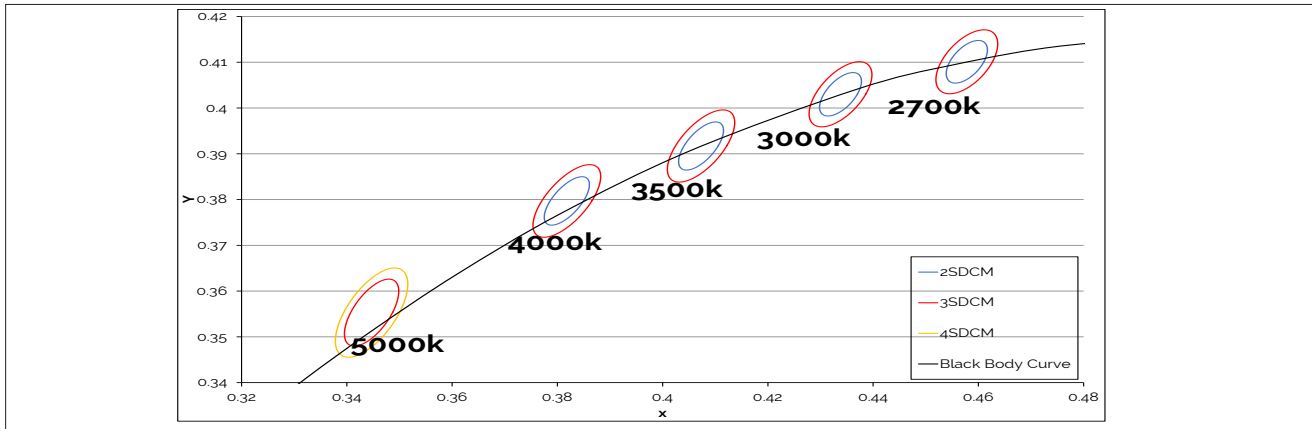

Note: Pulsed Test Conditions,  $T_c = 85^\circ\text{C}$

**Table 8: Warm and Neutral White xy Bin Coordinates and Associated Typical CCT (product is hot targeted to  $T_c = 85^\circ\text{C}$ )**

Bin Code	2700K	3000K	3500K	4000K
ANSI Bin (for reference only)	(2580K - 2870K)	(2870K - 3220K)	(3220K - 3710K)	(3710K - 4260K)
83 (3 SDCM)	(2651K - 2794K)	(2968K - 3136K)	(3369K - 3586K)	(3851K - 4130K)
82 (2 SDCM)	(2674K - 2769K)	(2995K - 3107K)	(3404K - 3548K)	(3895K - 4081K)
Center Point (x,y)	(0.4578, 0.4101)	(0.4338, 0.403)	(0.4073, 0.3917)	(0.3818, 0.3797)

**Table 9: Cool White xy Bin Coordinates and Associated Typical CCT (product is hot targeted to  $T_c = 85^\circ\text{C}$ )**

Bin Code	5000K
ANSI Bin (for reference only)	(4745K - 5311K)
84 (4 SDCM)	(4801K - 5282K)
83 (3 SDCM)	(4835K - 5215K)
Center Point (x,y)	(0.3447, 0.3553)

Note for Tables 8-g:

1. Bridgelux maintains a tolerance of +/- 0.007 on x and y color coordinates in the CIE 1931 color Space.

# Packaging and Labeling

Figure 22: V10 Packaging Tube

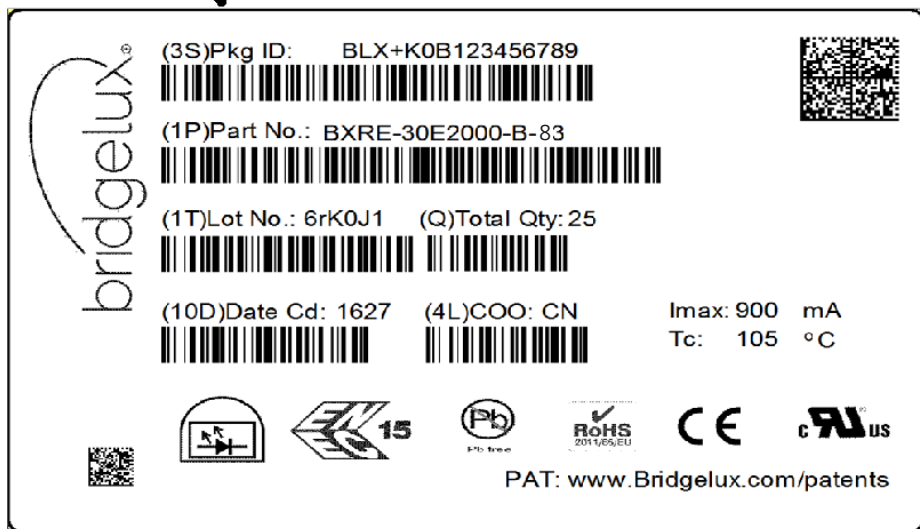

Box Label

Commercial Invoice  
and Packing list



Notes for Figure 22:

1. Each tube holds 30 V10 COB arrays.
2. One tube is sealed in an anti-static bag. Four bags are placed in a shipping box. Depending on quantities ordered, a bigger shipping box, containing four boxes may be used to ship products.
3. Each bag and box is to be labeled as shown above.
4. Dimensions for each tube are 8.3 (W) x 15.4 (H) x 430 (L). Dimensions for the anti-static bag are 75 (W) x 615 (L) x 3.1 (T) mm. Dimensions for the shipping box are 58.7 x 13.3 x 7.9 cm

# Packaging and Labeling

**Figure 23: Product Labeling**

Bridgelux COB arrays have laser markings on the back side of the substrate to help with product identification. In addition to the product identification markings, Bridgelux COB arrays also contain markings for internal Bridgelux manufacturing use only. The image below shows which markings are for customer use and which ones are for Bridgelux internal use only. The Bridgelux internal manufacturing markings are subject to change without notice, however these will not impact the form, function or performance of the COB array.

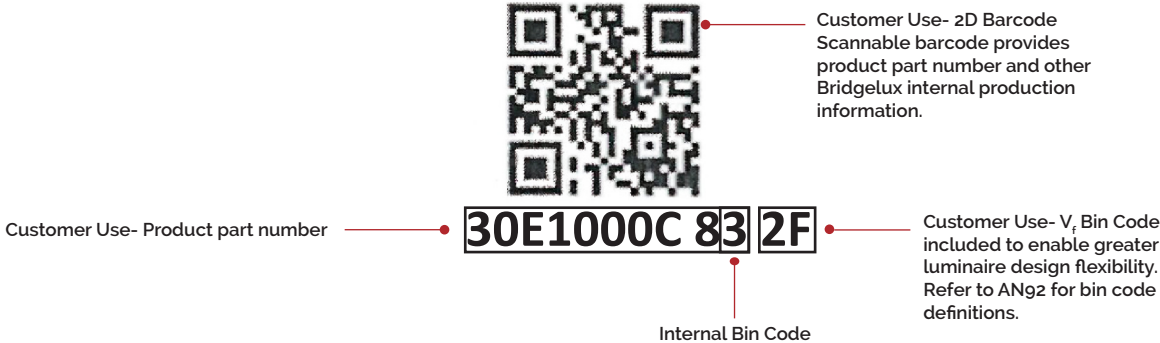

# Design Resources

## Application Notes

Bridgelux has developed a comprehensive set of application notes and design resources to assist customers in successfully designing with the V Series product family of LED array products. For all available application notes visit [www.bridgelux.com](http://www.bridgelux.com).

## Optical Source Models

Optical source models and ray set files are available for all Bridgelux products. For a list of available formats, visit [www.bridgelux.com](http://www.bridgelux.com).

## 3D CAD Models

Three dimensional CAD models depicting the product outline of all Bridgelux V Series LED arrays are available in both IGS and STEP formats. Please contact your Bridgelux sales representative for assistance.

## LM80

LM80 testing has been completed and the LM80 report is now available. Please contact your Bridgelux sales representative for LM-80 report.

# Precautions

## CAUTION: CHEMICAL EXPOSURE HAZARD

Exposure to some chemicals commonly used in luminaire manufacturing and assembly can cause damage to the LED array. Please consult Bridgelux Application Note AN101 for additional information.

## CAUTION: RISK OF BURN

Do not touch the V Series LED array during operation. Allow the array to cool for a sufficient period of time before handling. The V Series LED array may reach elevated temperatures such that could burn skin when touched.

## CAUTION

### CONTACT WITH LIGHT EMITTING SURFACE (LES)

Avoid any contact with the LES. Do not touch the LES of the LED array or apply stress to the LES (yellow phosphor resin area). Contact may cause damage to the LED array.

Optics and reflectors must not be mounted in contact with the LES (yellow phosphor resin area).

# Disclaimers

## MINOR PRODUCT CHANGE POLICY

The rigorous qualification testing on products offered by Bridgelux provides performance assurance. Slight cosmetic changes that do not affect form, fit, or function may occur as Bridgelux continues product optimization.

## STANDARD TEST CONDITIONS

Unless otherwise stated, array testing is performed at the nominal drive current.

# About Bridgelux: Bridging Light and Life™

At Bridgelux, we help companies, industries and people experience the power and possibility of light. Since 2002, we've designed LED solutions that are high performing, energy efficient, cost effective and easy to integrate. Our focus is on light's impact on human behavior, delivering products that create better environments, experiences and returns—both experiential and financial. And our patented technology drives new platforms for commercial and industrial luminaires.

**For more information about the company, please visit**  
**[bridgelux.com](http://bridgelux.com)**  
**[twitter.com/Bridgelux](https://twitter.com/Bridgelux)**  
**[facebook.com/Bridgelux](https://facebook.com/Bridgelux)**  
**[youtube.com/user/Bridgelux](https://youtube.com/user/Bridgelux)**  
**[linkedin.com/company/bridgelux-inc-\\_2](https://linkedin.com/company/bridgelux-inc-_2)**  
**WeChat ID: BridgeluxInChina**



46410 Fremont Boulevard  
Fremont, CA 94538 U.S.A.  
Tel (925) 583-8400  
**[www.bridgelux.com](http://www.bridgelux.com)**

© 2022 Bridgelux, Inc. All rights reserved. Product specifications are subject to change without notice. Bridgelux, the Bridgelux stylized logo design, Vero, V Series and V Series HD are registered trademarks, and Decor Series is a trademark of Bridgelux, Inc. All other trademarks are the property of their respective owners.

**Bridgelux V10 Fgo Array Series Product Data Sheet DS446 Rev. A (03/2022)**