

# BM200-\*\* Battery Tester-Charger-Discharge-Maintainer

## User Manual



REV2.0

Revision Date: Feb 2023

## Features

BM200-xx is an intelligent instrument that integrates the four functions of battery testing(analyzing), charging, discharging and maintenance.

It is designed with a portable aluminum alloy shell, color TFT display.

BM200 is widely used for performance testing and routine maintenance of most power batteries and energy storage batteries.

BM200-05 is for 2V~4V 10Ah~400Ah Li-ion /LiFePO4 /Pb-Acid /NiMH

BM200-32 is for 2V~28V 2Ah~80Ah Li-ion /LiFePO4 /Pb-Acid /NiMH

The four main functions are

1. **Charging:** can set constant current & constant voltage for charging process.
2. **Discharge:** can set constant current value & cut-off voltage for discharging.
3. **Test/analyze:** can measure battery voltage, internal resistance, SOC, SOH, true effective capacity Ah value and charge/discharge curves.
4. **Maintenance:** for the battery that has been left standing or in standby for more than 6 months, do a auto maintenance process to keep or recover battery good active capacity and health life.

Input of BM200 is AC100~240V, universal global voltage range. The adjustable range of output constant current charging current is 2A~30A (for -05) or 1A~6A (for -32); The charging limit voltage and the discharge cut-off voltage can also be adjusted manually. It has a variety of abnormal safety protection measures such as battery reverse connection, wrong connection, short circuit, overvoltage, undervoltage, over-current and over-current heat.

BM200-xx-B/D has Bluetooth function, through which users can view the historical charging and discharging data and curves with their phones or PC.

BM200-xx-C/D has RS485 communication interface, which can realize the cascade function. Multiple BM200 cascades can simultaneously test and maintain up to 255 series of multi connected high-voltage battery packs.

View of product

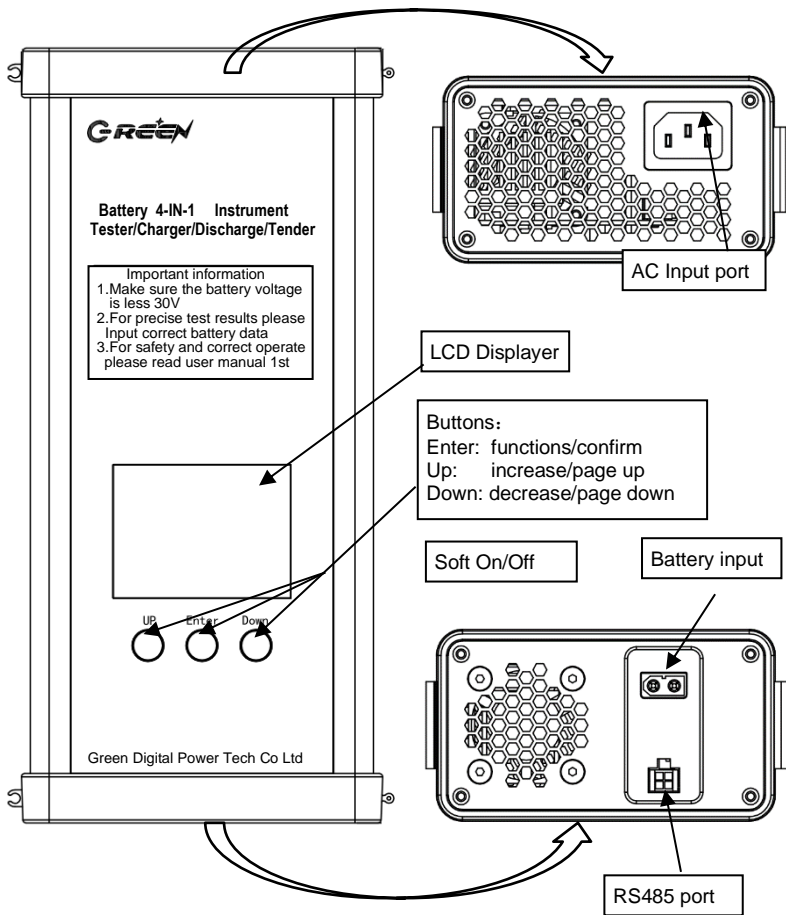

## How to use

- 1. Connect battery:** Please make sure the voltage of the battery un does not exceed 30V, find red and black alligator clip cable, insert it's yellow plug to BM200, let red clip connect to positive pole of battery, and black clip connect to negative pole.

If the battery is connected correctly and there is still electricity in the battery, the LCD screen of BM200 will be following displayed

### BM200 Battery 4-in-1

AC: NG Battery: Ok

1. Set battery param
2. Run last param
3. Set system param

- 2. Connect AC power:** If you only want to test battery parameters quickly, you can skip to step 3 directly, without connecting to AC power.

To charge, discharge and maintain battery, or accurately measure the battery capacity Ah value and healthy SOH value, please insert mains power (AC100V~240V), if AC power is connected, LCD displays the following information:

### BM200 Battery 4-in-1

AC: OK Battery: Ok

1. Set battery param
2. Run last param
3. Set system param

Note: Following examples are all based on BM200-05 @ 3.2V100Ah LiFePO4 battery.

**3.Set Battery Parameter:** BM200 can be used for many types batteries. To get the accuracy test results and charge safety, at first you should set the connected battery parameters. ***If the battery connected is the same as last time, please refer to Clause 3.2; Otherwise, please execute the following***

**3.1 select [1. Set battery param]** (When the background of this item is highlighted, it means selected, the same below), press <Enter> Key, screen will be:

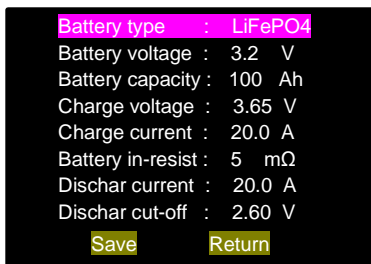

**[Battery type]:** Select of one from LiFePO4, Li-Ion, Pb-Acid, NIMH, NICD,

**[Battery voltage]:** Select battery nominal voltage from 2.0V ~ 28.8V, marked on battery label.

**[Battery capacity]:** Input the Ah value of battery capacity, which is marked on battery label.

**[Charge voltage]:** Charge voltage limit during charging process, marked on battery label.

***This step can be skipped, BM200 will auto set a good default data.***

**[Charge current]:** Set a constant current for charging process, recommend is 0.1C~0.5C.

***This step can be skipped, BM200 will auto set a good default data.***

**[Battery in-resist]:** Set the battery internal resistance, which is listed on battery datasheet.

This data is only used for evaluate battery SOH. If you have no data,  
***this step can be skipped, BM200 will auto set a general default data.***

**[Dischar current]:** Set a constant current for discharge process, recommend is 0.1C~0.5C.

***This step can be skipped, BM200 will auto set a good default data.***

**[Dischar cut-off]:** Set cut-off voltage for discharge process. Recommend is 0.8\*rating voltage.

***This step can be skipped, BM200 will auto set a good default data.***

Note: [Battery type], [Battery voltage], and [Battery capacity] is necessary for setting process, the rest 5 items can be skipped if you have no special request.

**Press <Up> or <Down> keys to highlight the items, press <Enter> key to Confirm selection, then press <Up> or <Down> change data, press<Enter> when the data is correct as you wanted. After that, press <Save>. Then screen will enter 3.3 step.**

**3.2 Select [2. Run last param], if the battery data is same as last time for BM200.**

Press <Up> or <Down> keys to highlight the items, press <Enter> key to Confirm selection, **Then screen will enter 3.3 step.**

**3.3 After done 3.1 or 3.2 step, screen will be following:**

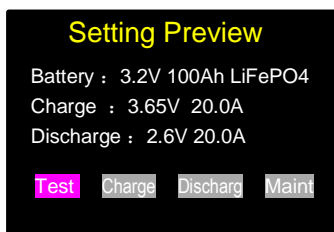

If the parameters are correct, users can select the four listed in the menu according to their task requirement functions. Use <Up>, <Down> and <Enter> to select and run. If errors are found in the preview parameters, please press <Enter> for more than 2 seconds, and the system will return to the home page to reset battery parameters.

## 4. Main functions

**4.1 [Test]: Measure battery voltage, internal-resistance, SOC and SOH within 5 seconds**

SOC, means State-of-charge of battery, range is 0 ~ 100%.

SOH, means State-of-health of battery, range0~100%.

Run [Test] function, after 5 seconds, screen will display test results:

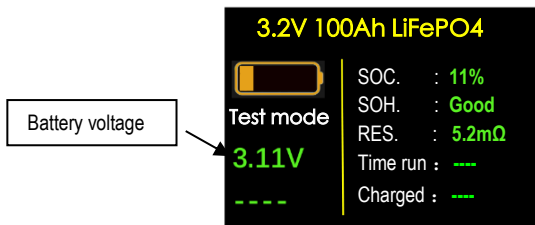

The fast tested SOC percentage is built based on the measured battery voltage and equipment learning. This SOC is calculated by looking up the voltage-SOC table.

This fast tested SOC error may be relatively higher.

The fast tested SOH, battery health status, is also based on the tested internal resistance of battery. This SOH is calculated by looking up the resistance-SOH table.

This fast tested SOC error also may be relatively higher.

To obtain accurate SOC and SOH, please select [Maintenance] function and run a cycle.

**4.2 [Charge]:** According to the selected battery type and charging parameters, the system automatically calls the best charging process curve. When charging, the LCD displays the following information:

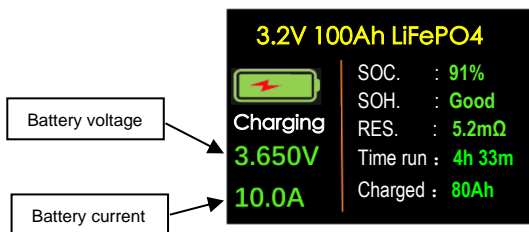

After battery is fully charged, the display screen will two different display contents:

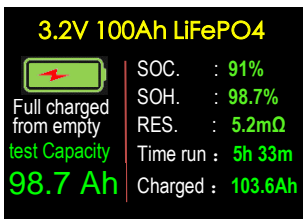

When you charge battery from empty state, after full charged, you will get an accurate capacity.

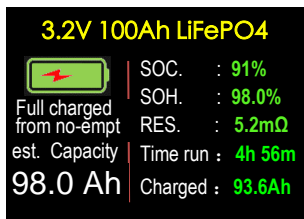

When you charge battery from non-empty state, after full charged, it can get an estimated capacity

After the battery is fully charged, to view the charging curve of the battery, please press <Up> Key, screen will display the complete battery charging curve, as follows:

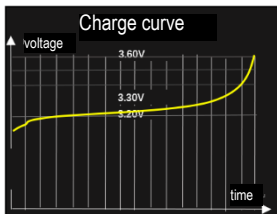

Press <Up> or <Down> key again, you can switch the graph and list pages alternately

- 4.3 [Discharge]: Automatically discharge according to the selected parameters; During discharging process, screen will be following view:

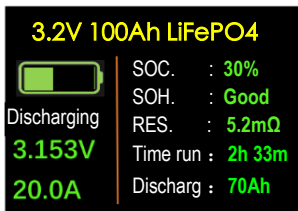



After the battery is emptied, the display screen will There are two different display contents:

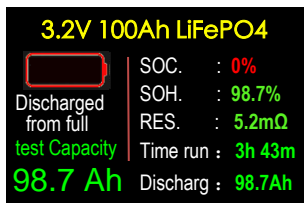

When discharge battery from full charged state, after discharged empty, it will get an accurate capacity.

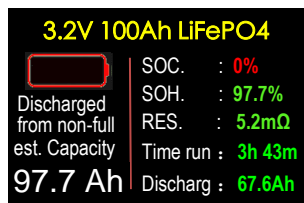

When discharge battery from non-full state, after discharged empty, it will get an estimated capacity.

After the battery is fully charged, to view the charging curve of the battery, please press <Up> Key, screen will display the complete battery charging curve, as follows:

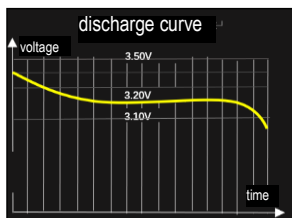

Press <Up> or <Down> key again, you can switch the graph and list pages alternately

#### 4.4 [Maint]: Automatic maintenance based on selected battery parameters:

For batteries that have been idle for more than 6 months or have been floating charged for a long time, it should be regularly (preferably every 6 months or so) standard charging and discharging maintenance process. The standard maintenance procedure is to use 0.2C current first fully charge the battery - then drain the battery with 0.1C current - then use 0.1C charge current to full fill the battery. After finished this maintenance process, the vitality, the life time and the effective capacity of battery will be protected and improved to the maximum.

After starting the automatic maintenance function, the LCD screen displays the status message of "Maintain \*\*", here \*\* refers to CH--charging, DS--discharging, OK-- completion all maintenance jobs.

Examples are as follows:

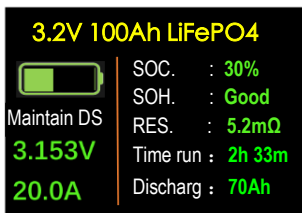

Generally, a complete maintenance process takes about 30 hours. After the process is completed, the battery capacity Ah value is the most accurate. Press <Up> key, the display screen will display the recorded complete battery charging/discharging curves.

*Tips: During charging, discharging, maintenance and other processes, the user can press <Enter> briefly Pause, press again to resume; Long press <Enter> for 2 seconds to terminate the current process and return to the initial main page*

#### 4. Bluetooth function:

BM200 - \* \* B/D has Bluetooth communication function, through which users can use mobile phones, PAD or PC checks the historical charging and discharging data and curves of the battery pack, also remotely sets and controls BM200 working status.

The BM200 series provides Android APP and PC Windows applications software. Please refer to the appendix "Introduction to the Use of Android App of BM70/200 Battery Tester" document.

*Note: Once the BM200 device is successfully connected to the mobile phone, tablet or PC through Bluetooth, the function keys on the BM200 panel will be temporarily frozen and disabled. At this time, only the function keys in the mobile phone or PC APP can control the battery settings and function operation of the BM200. When the APP program is finally closed, the panel keys of the BM200 can resume their normal functions.*

5. Cascading function:

BM200 - \* \* C/D has cascading function. Multiple BM200 running at cascading can simultaneously apply for more than 125 series battery pack connected in series. Which is high-voltage and large capacity. for inspection and maintenance.

Here show you how to use cascading function:

- 1) Select a BM200 - \* \* C/D device with #01 RS485 address can running as a host. Actually the default RS485 address of all BM200 - \* \* C/D device are #01.
- 2) All other BM200 - \* \* C/D devices participating in the cascade must be designated as slave mode, and the 485 addresses of the devices must be changed to "# 02", "# 03" and "#nn", according to the connection order of the battery pack. The 485 address can be modified via [3. Set System Param] on the initial page. Press the <Up> key briefly, and the address will be +1. Press the <Enter> key briefly, and the current modified address will be confirmed to take effect. Press <Enter> 2 seconds return to main page.
- 3) Connect each BM200 equipment participating in the cascade with the 485 connection cable; Each BM200 is connected with its own number of positive and negative battery poles. The following figure shows an example of 8 BM200-05C/D cascades
- 4) After cascading, only # 01 host has the power to set battery parameters and control functions. The control of slave is prohibited. The host will send the same battery setting parameters to each slave, and start/ stop function operations synchronously. The display screen of each slave will display the voltage, current, capacity, internal resistance, SOC, SOH and other information of the corresponding battery unit.

It is recommended that the host use APP (for phone, PAD or PC) to set and control the operation in the cascading state, because in this way, you can fully understand the details of each battery cell on the mobile phone or tablet.

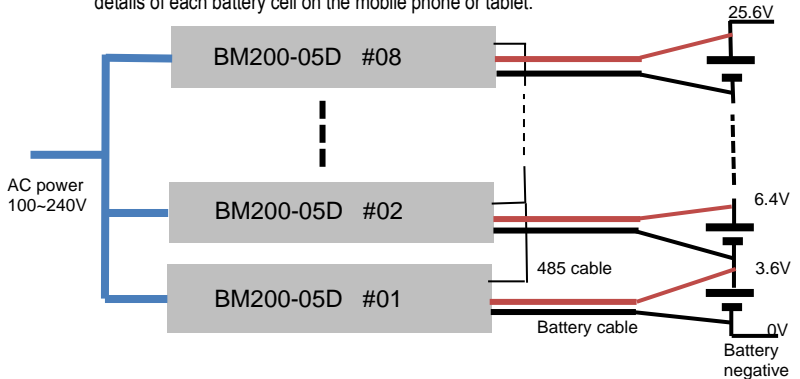

**Specification**

Items \ model	BM200-05 [B, C, D]	BM200-32 [B, C, D]
AC input power	100~240V 50HZ	
Suitable battery type	Pb-Acid(AGM, VRLA, Gel), Li-Ion, LiFePO4, NiMH, NiCd	
Charging method	PreCharge -- C.C main charge -- special charge CV or CC -- end charge	
Suitable battery capacity	10Ah ~ 400Ah	2Ah ~ 80Ah
Suitable battery voltage*1	2.0V ~ 4.0V	2.0V ~ 29.4V
Charge/discharge voltage set	2.0V ~ 5.0V	2.0V ~32.0V
Charge current set	2A ~ 30A	1A ~ 8A (150W Max)
Discharge current set	1A~25A ( 90W Max.)	1A~ 6A (90W Max)
Temperature compensation	Auto compensation charge voltage according to environment temperaturure	
Voltage test precision	+ - 1.0%	
Current test precision	+ - 2.5%	
Capacity test precision	+ - 2.5%	
Abnormal protection	Shorted, reversed, OVP, OCP, OLP, OTP,	
Bluetooth function	-B and -D model have this function	
RS485 communication	-C and -D model have this function	
Cascade function		
Size and weight	240*115*65mm, 1.5kg	
Safety standard	CE, EN62368, EN61000	

Note 1 \*: Multiple modules are used in cascade, which can perform internal resistance and capacity testing, performance maintenance, and serial equalization for each single battery of multiple series battery packs

## Safety notes

- ✧ Be sure to understand the information of the battery to be charged or discharged accurately. If the parameters is set up incorrectly the battery may severely be damaged. Especially Lithium battery can cause a fire or an explosion by over-charging.
- ✧ If any malfunction is observed immediately terminate the process and refer to the operation manual.
- ✧ Keep away the unit from dust, damp, rain, heat direct sunshine and vibration. DO not drop it.
- ✧ This device and the battery to charge or discharge should be set up on a head-resistant, non-inflammable and non-conductive surface. Never place them on a car seat, carpet or similar. Keep all the inflammable volatile materials well away from operating area.
- ✧ The outer case slots and fan serve to cool the device so must not be covered of enclosed. Provide good ventilation.
- ✧ Please only use the official cable and clips, which are provided with device package. Other type cable or clip will affect testing and charging accuracy.
- ✧ Please clamp battery terminal poles tightly, otherwise the test result will be not Accuracy.
- ✧ Please don't want to charge batteries when:
  - The battery voltage exceeds the limit of BM200's specification.
  - Battery pack, which consists of different types of cell.
  - Non-rechargeable batteries (Explosion hazard).
  - Faulty or damaged battery.
  - Battery fitted with an integral charge circuit or special protection circuit.
  - Batteries are electrically linked to user's loads in device.

## Appendix I: BM\*\* APP for Android

### Brief introduction

This APP software is designed for BM\*\* family Battery Tester-Charger-Discharger-Tender, as a convenient user tool. This software is used to pair, connect and communicate through BLE Bluetooth. Through this function, users can view the historical charging and discharging data and curves of the battery pack with Android phones, and remotely set and control the working state of the device.

### How to use

In main page, there are three function buttons: [SEARCH BLE], [SET BATTERY PARAM] and [RUN LAST PARAM], also, there are three status on the lower of main page: AC power, Battery and BLE. When Bluetooth connected successfully, the "BLE" will show "OK", when AC power and Battery connected correctly, their status are all show "OK".



### Connect Bluetooth:

Click [SEARCH BLE] button, find your BM\*\* device and select it. Note: Before use, you need to give the software Bluetooth permission and location permission and open Bluetooth and location, otherwise you will not be able to search for Bluetooth devices.



*Note: Once the BM device is successfully connected to the mobile phone or tablet computer through Bluetooth, the function keys on the BM panel will be temporarily frozen and disabled. At this time, only the function keys in the mobile phone or tablet APP can control the battery settings and function operation of the BM. When the APP program is terminated and closed, the BM panel keys can resume their normal functions.*

**Set battery parameter:**

Click [SET BATTERY PARAM] button, enter below page:

11:28 30%

**GREEN**

**Set battery param**

battery type:	LI
battery voltage:	FE
battery capacity:	PB
charging voltage:	NI
charging current:	NI
internal resistant:	1.0
discharge current:	2.0
stop voltage:	1.0
protection temp:	40.0

SAVE QUIT

***Please see page 5 (section 3.1) to learn how to set all these parameters value.***

*Note: [Battery type], [Battery voltage], and [Battery capacity] is necessary for setting process, the rest items can be skipped if you have no special request.*



## Preview the running parameters:

This interface will display the parameters you have just set. If the preview parameters are found to be incorrect, click the [RETURN] button to return to the operation parameter setting interface and reset the parameters.

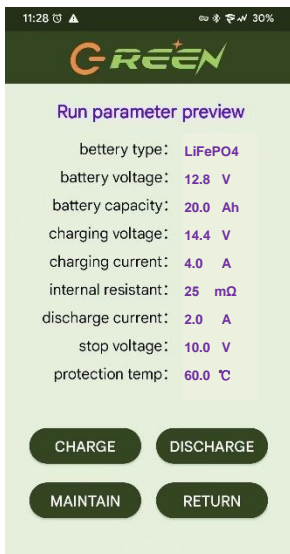

Below the preview parameters are four function key buttons: [CHARGE], [DISCHARGE], [MAINTAIN] and [RETURN]. Click the function key to enter the corresponding operation interface.

### Running view:

The upper part of the operation interface will display the battery voltage and capacity values set by the user. The mode displays different states, and then show the battery voltage, current, capacity, internal resistance, SOC and SOH. If the equipment works in multi section cascade mode, the "Serial Number" column will the tested data for each battery.

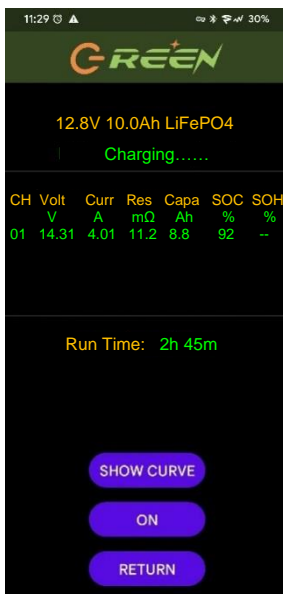

After charging or discharging done, click the [SHOW CURVE] button to enter the charging and discharging curve viewing interface. Click [SHOW CURVE] button again, return the earlier main data view screen.

[ON] button will let user start or stop the charging/discharging/maintaining process.