

User Manual

8500B Series

Programmable DC Electronic Loads



Contents

1	General Information	5
1.1	Product Overview	5
1.2	Package Contents	5
1.3	Product Dimensions	6
1.4	Rackmount Installation	6
1.5	Front Panel Overview	6
1.5.1	Combination Keys	7
1.6	Rear Panel Overview	8
1.7	Display Overview	9
2	Getting Started	10
2.1	Input Power	10
2.2	Fuse Requirements	10
2.2.1	Fuse Replacement	10
2.3	Input Connections	10
2.4	Preliminary Check	11
2.4.1	Verify AC Input Voltage	11
2.4.2	Self-test Errors	12
2.4.3	Input Check	12
2.4.4	Check Model and Firmware Version	12
3	Front Panel Operation	13
3.1	Local Mode/Remote Mode	13
3.2	Constant Current (CC) Mode	13
3.2.1	Configure CC Parameters	13
3.3	Slew Rate Measurement and Actual Transition time	14
3.4	Constant Voltage (CV) Mode	14
3.4.1	Configure CV Parameters	14
3.5	Constant Power (CW) Mode	14
3.5.1	Configure CW Parameters	14
3.6	Constant Resistance (CR) Mode	15
3.6.1	Configure CR Parameters	15
4	Front Panel Operation	16
4.1	Local Mode/Remote Mode	16
4.2	Constant Current (CC) Mode	16
4.2.1	Configure CC Parameters	16
4.3	Slew Rate Measurement and Actual Transition time	17
4.4	Constant Voltage (CV) Mode	17
4.4.1	Configure CV Parameters	17
4.5	Constant Power (CW) Mode	17
4.5.1	Configure CW Parameters	17
4.6	Constant Resistance (CR) Mode	18
4.6.1	Configure CR Parameters	18
4.7	CR-LED Test Function	18
4.7.1	Setup	18
4.7.2	External Triggering	19

5	Rear Panel Functions	20
5.1	Remote Sensing	20
5.2	External Triggering	21
5.3	Current Monitoring (I Monitor)	21
5.3.1	Remote Sensing	21
5.3.2	Current Monitoring (I Monitor)	21
6	Advanced Functions	22
6.1	Short Operation	22
6.2	Short-circuit Analog Function	22
6.3	Transient Operation	22
6.3.1	CC Mode	23
6.3.2	CV, CW, and CR modes	23
6.4	LIST Operation	23
6.4.1	Configure List	24
6.4.2	Run List	24
6.4.3	Disable List Mode	25
6.5	Battery Test Function	25
6.5.1	Test Configuration	25
6.5.2	Enable Battery Test Mode	26
6.5.3	Recall Battery File	26
6.5.4	Start Battery Test	26
6.6	Program Mode	26
6.6.1	Example: Small AC/DC power supply test	26
6.6.2	Start Auto Test File	31
6.6.3	Recall Test File	31
6.7	Measurement of Voltage Rise Time	31
6.7.1	Set initial Voltage and Final Voltage	31
6.8	Ripple Function	32
7	Configuration Functions	33
7.1	VON Function	33
7.2	Menu Operation	33
7.3	System Menu	33
7.4	Menu Options	33
7.5	System Menu (System)	34
7.6	Config Menu	35
8	System Settings	36
8.1	Run Recall Edit	36
8.2	To recall the settings	36
8.3	To run the OPP test	36
8.4	Key Lock	36
8.5	Restore Factory Default Settings	37
8.5.1	Configure Power-On State	37
8.5.2	Load On Knob	38
8.5.3	Configure Trigger Source	38
8.5.4	Save/Recall Instrument Settings	38
8.5.5	Select Storage Group	39
8.5.6	Save Settings	39
8.5.7	Recall Settings	39
8.5.8	Display Input On Timer	40
8.5.9	Remote Interface Setup	40
8.5.10	RS-232	40
8.5.11	CONFIG Menu	41
8.5.11.1	Von Operation	41

8.5.12	Configure Protection Settings	41
8.5.13	PROTECT MENU	41
8.5.14	Max-P A-Limit P-Limit Time	41
8.5.15	Overcurrent Protection (OCP)	42
8.5.16	Overpower Protection (OPP)	43
8.5.17	Recall OPP File	44
8.5.18	Overvoltage Protection (OVP)	45
8.5.19	Over-temperature Protection (OTP)	45
8.5.20	Reverse Voltage Protection (LRV/RRV)	45
8.5.21	Configure Timed Input	45
8.5.22	Measurement Configurations	46
9	Protection Functions	47
9.1	OCP Test Function	47
9.2	OPP Test Function	48
9.3	OPP TEST	48
9.4	Over Voltage Protection (OVP)	48
9.5	Over Current Protection (OCP)	49
9.6	Over Power Protection (OPP)	49
9.7	Over Temperature Protection (OTP)	49
9.8	Reverse Voltage Protection (LRV)	50
10	Remote Operation	51
10.1	Interface Connection	51
10.2	Serial Interface	51
10.2.1	GPIB	51
10.2.2	USBTMC	51
10.2.3	Remote Commands	51
11	Troubleshooting Guide	52
11.1	General	52
11.2	Remote Control	52
11.3	Error Information References	52
11.4	Exception handling	52
12	Specifications	54
13	Service Information	55
14	LIMITED THREE-YEAR WARRANTY	56

General Information

1.1 Product Overview

The 8500B Series DC Electronic Loads are versatile instruments used for static and dynamic testing of DC power supplies, batteries, DC-to-DC converters, battery chargers, and other applications including fuel-cell, and solar cell test. Primary modes include constant voltage (CV), constant current (CC), constant resistance (CR), and constant power (CW). A wide range of dynamic loading applications can also be simulated through user-programmable slew rates, load levels, duration, and conducting voltage. Further, transient, list mode, battery mode, and LED modes further extend testing capabilities. Versatile triggering options allow the dynamic load behavior to be synchronized with other events. The DC load is remotely programmable via the TTL serial interface. This interface requires 0-5V signal levels and can connect to typical serial ports via an adapter such as the IT-E132B.

Features:

- CC/CV/CR/CW operating modes
- List mode
- Transient mode
- Measurement speed up to 40 kHz
- Remote sense function
- Battery test function
- OCP and OPP automatic test
- CR-LED function
- Store/recall up to 100 setups
- Analog current monitoring
- Adjustable slew rate in CC mode
- OVP/OCP/OPP/OTP and reverse voltage protection

1.2 Package Contents

Please inspect the instrument mechanically and electrically upon receiving it. Unpack all items from the shipping carton, and check for any obvious signs of physical damage that may have occurred during transportation. Report any damage to the shipping agent immediately. Save the original packing carton for possible future reshipment. Every instrument is shipped with the following contents:

- 8500B series DC Electronic load
- IT-E132B USB to TTL adapter
- AC Power Cord
- Certificate of Calibration
- Test Report

Verify that all items above are included. If anything is missing, please contact B&K Precision.

1.3 Product Dimensions

All models are designed to fit in a standard 19-inch rackmount. The dimensions are shown in **Figure 1.1**.

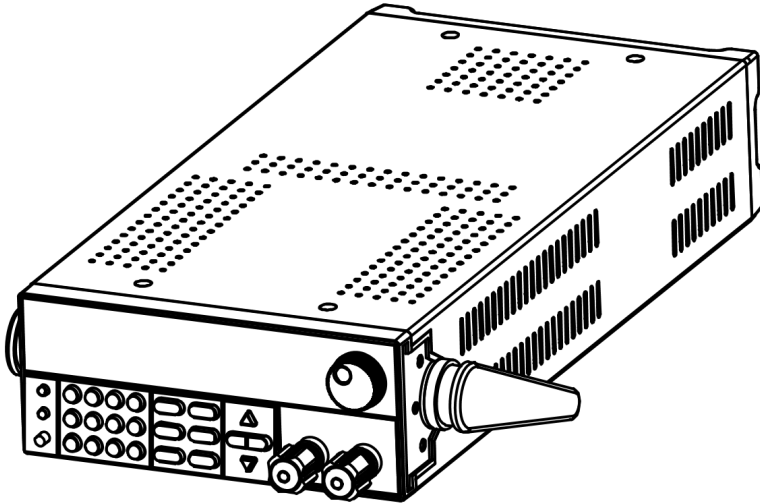

Dimension:
Width: 214.5mm
Height: 88.2mm
Depth: 354.6mm

Detailed Dimension Drawing

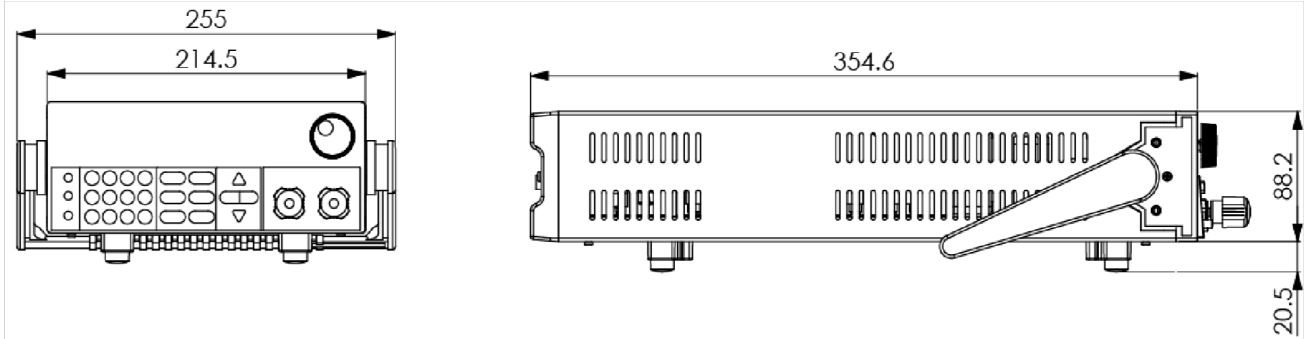

Figure 1.1 External Dimensions - Half-rack models

1.4 Rackmount Installation

The instrument can be installed in a standard 19 inch rack. For half-rack models, the optional rackmount kit IT-E151 is required. **Figure 1.2** shows one of the half-rack sized units using the IT-E151 rackmount kit. This rackmount kit also accommodates up to two half-rack models installed side by side. The full size 8514B includes rack mounting ears.

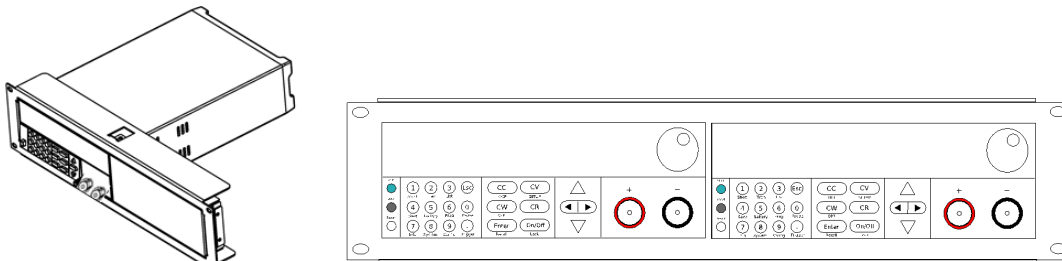

Figure 1.2 Half-Rack sized Unit

1.5 Front Panel Overview

See **Figure 1.3**.

























Item	Description
1	VFD Display
2	Power Switch
3	Numeric Input and Advanced Functions
4	Mode keys and Input Control
5	Navigation Keys
6	Input Terminals
7	Rotary Input Knob

Figure 1.3 Front Panel

1.5.1 Combination Keys

Press  button first and then other keys to activate the more advanced functions.

-  +  Turn short circuit on or off.
-  +  Start or stop transient condition.
-  +  Set LIST operation parameters.
-  +  Store the DC Load state in non-volatile memory.
-  +  Turn on or off battery testing function.
-  +  Enter auto test function.
-  +  Display product's Model/SN/Version.

- Shift +  System menu setting
- Shift +  Configure menu setting
- Shift +  Press this button if you need a pause when running an auto test file.
- Shift +  Cause an immediate trigger.
- Shift +  Enter OCP test function.
- Shift +  Set detailed parameters in CC/CV/CW/CRmode.
- Shift +  Enter OPP test function.
- Shift +  Recall the DC Load state from non-volatile memory.
- Shift +  Key lock function

1.6 Rear Panel Overview

The rear panel connections are shown in **Figure 1.4**.



Item	Description
1	Power Input and Fuse Holder
2	AC Voltage Switch
3	Current Monitor Output
4	Remote Sense and Trigger Input
5	TTL (5V) Communication DE-9 Connector

Figure 1.4 Rear Panel

1.7 Display Overview



Item	Description
1	Measured Voltage
2	Measured Current
3	Measured Power
4	Set Value
5	Input Off indicator, lit when input is off
6	Operation mode indicators (CC, CV, CW, CR)
12	Remote control active indicator
13	Error indicator
14	Waiting for Trigger indicator
15	Timer indicator
16	External indicator
16	Remote Sense active indicator
17	Protection event indicator
18	Auto range
19	Key Lock indicator
20	Shift indicator

Getting Started

Before connecting and powering up the instrument, please review and go through the instructions in this chapter.

2.1 Input Power

The load has a selectable AC input that accepts line voltage input within:

Voltage	Frequency
115 V (+/-10%) or 230 V (+/- 10%)	47 Hz – 63 Hz

Table 2.1 Input Power Requirements

Use the line voltage selector switch in the back to switch between 110 V and 220 V operation.



Disconnect all cables including the power cord from the instrument when changing the instrument's line voltage. After changing the line voltage setting, ensure the instrument has fuses of the proper ratings and types for the selected line voltage before applying line power.

2.2 Fuse Requirements

An AC input fuse is necessary when powering the instrument. Below is a table of the fuse required for all models operating with either 110 VAC or 220 VAC input. See **Table 2.2**. The fuses are **5mm x 20mm High Energy Slow Blow** type (ceramic casing with sand fill).

Model	Fuse Specification (110 VAC)	Fuse Specification (220 VAC)
8542B	1.25 A, 250 V	500 mA, 250 V
8500B	1.25 A, 250 V	500 mA, 250 V
8502B	1.25 A, 250 V	500 mA, 250 V
8510B	2.5 A, 250 V	1.25 A, 250 V
8514B	2.5 A, 250 V	1.25 A, 250 V

Table 2.2 Fuse Ratings

2.2.1 Fuse Replacement

Follow the steps below to replace to check the fuse:

1. Locate the fuse box next to the AC input connector in the rear panel, see **Figure 2.1**.
2. With a small flat blade screwdriver, insert into the fuse box slit to pull and slide out the fuse box as indicated below.
3. Check and replace fuse (if necessary) for the desired line voltage operation.

2.3 Input Connections

The main DC input terminal is a screw type binding post terminal located in the front panel, holes are included for inserting wires, and the binding post also includes “banana jack” connections. Each connection allows for different

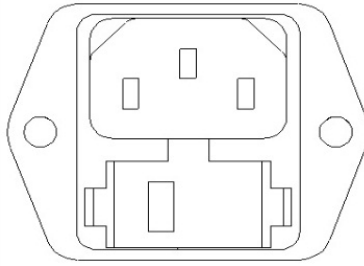

Figure 2.1 Fuse Holder

current levels. The “banana” input is capable of up to 10 A of current. Any more current is not recommended and could lead to excessive connector heating, melting and worse.

Note: The screws on the terminals can be completely removed to allow for ring type adapters. The screw posts are 7mm in diameter.

Due to the high current rating of the DC load, proper wire sizes are necessary for safe connectivity and to prevent wires from overheating.



Before connecting wires to the input terminals, turn OFF the load to avoid damage to the instrument and the device under test (DUT).



High Current Connection



Low (<10 A) Current Connection

Figure 2.2 Input Connections

2.4 Preliminary Check

Complete the steps in this section to verify that the load is ready for use.

2.4.1 Verify AC Input Voltage

Verify and check to make sure proper AC voltages are available to power the instrument. The AC voltage range must meet the acceptable specification as explained in Section ??.

Connect AC power cord to the AC receptacle in the rear panel and press the power switch to the ON position to turn ON the instrument. It will run through a self test procedure with the screen shown below:

2.4.2 Self-test Errors



Connect AC power cord to the AC receptacle in the rear panel and press the power switch to the ON position to turn ON the instrument. Various elements of the system are checked during the power-on self test routine. If any occur, they are reported during the power-up procedure. See [Section 11](#) for troubleshooting and error information details. During self-test, the display displays "System Init", and dots are displayed showing the test progress level.

2.4.3 Input Check

Follow the steps below to check that the load is operating correctly, and that the load elements (power transistors) are not damaged. A DC power supply rated for at least 5V and 1 A is required for this check.

1. Connect the input terminal to a DC power supply and configure the supply to output 5 V and current limit to 1 A.
2. Power on the load. The display will show the "OFF" annunciator above the voltage display.
3. Turn on the DC power supply's output. Observe the load's measured voltage display, it should read approximately 5 V.
4. Press the "CC" button to enable the constant current load mode.
5. Use the keypad to enter 0.5 A. Press the Enter key to set the value.
6. The display should show **CC = 0.500A** on the bottom right.
7. Press "On/Off" to enable the load. The "On/Off" button should light up, and the "Off" indicator on screen should disappear. The measured current should now display a value close to 0.5 A.
8. This setup verifies that the load is drawing power correctly from the power supply.



If the load does not show 5 V, or shows significant current draw from the connected power supply, the load may be damaged and need service. If when the supply is connected, showing 5 V on the load's display, and no current is drawn, the load may be damaged and need service.

Note: If the load is not drawing power from the DC power supply, check all load protection limits and settings within the menu to verify that the load is configured to allow drawing power at 5V, 0.500 A. Also, verify that the CC mode parameters are setup to operate within the configured valid ranges by pressing  + 

If after checking all of the above, and verifying the power supply used for testing is not at fault, contact B&K for further assistance.

2.4.4 Check Model and Firmware Version

The model and firmware version can be verified by using the *IDN? query remote command. It can also be found from the front panel:

1. Press  and 
2. The display will show the following:

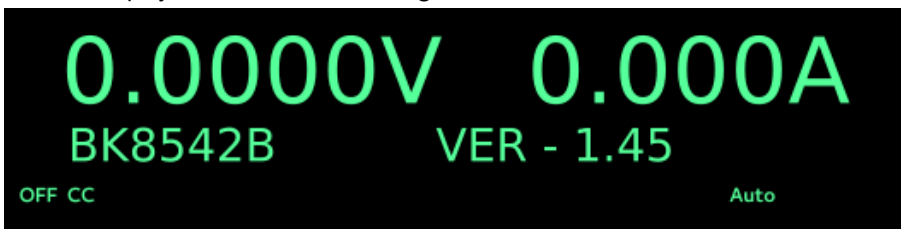

3. This shows the model to be a BK8542B with Firmware: 1.45
4. Press (esc) to return to the normal display.

Front Panel Operation

The electronic load provides the following modes:

- Constant current (CC) operation mode
- Constant voltage (CV) operation mode
- Constant resistance (CR) operation mode
- Constant power (CW) operation mode

3.1 Local Mode/Remote Mode

The 8500B series can either be operated locally or remotely. When in “Remote” mode, the **RMT** indicator will be lit. When in this mode, the front panel of the load is disabled and all commands are issued via the serial interface. In order to exit “Remote” mode and work in “Local” mode, press the “Local” button. This is the small grey button on the left hand side of the numeric keypad.

3.2 Constant Current (CC) Mode

In this mode, the load will draw the specified current as long as the source is capable of delivering it. The load uses transistors in parallel to implement the load circuit, and as such there are some limits. For example, the load has a finite minimum resistance determined by the R_{dsOn} of the transistors. Next, given the resistance limits, there is a limit to the amount of current that may be drawn for a given voltage. The datasheet shows curves for this limit in the section called “Low Voltage Operation”. Please refer to the datasheet for details for each model.

3.2.1 Configure CC Parameters

There are several parameters that should be setup prior to operating in CC mode. First, enable the “CC” mode of operation by pressing the CC mode key. Next, enter the setup menu by pressing “Shift” and then the “CV” key. Above the “CV” key, “Setup” is written. The following are the available menu items, scroll through them with the up/down arrow keys or by entering a value and pressing enter.

- Range** This defines the maximum allowed current set value. Use this limit to protect against accidentally entering excessive current values either from the keypad or dial.
- High** This is the voltage high limit for the automatic test mode, it does not apply otherwise. During automatic test mode, the device under test (DUT) must be operating below the configured value for the test to PASS upon completion. If the DUT operates above the configured value, the test will FAIL upon completion.
- Low** This parameter refers to the voltage low limit for the automatic test mode. During automatic test mode, the DUT must be operating above the configured value for the test to PASS upon completion. If the DUT operates below the configured value, the test will FAIL upon completion.

- Rise Up/ Fall Down** These parameters define the current slew rate of the load as it changes to a new programmed value. The programmed slew rate takes effect immediately when set, so if the transient or triggered modes are active, it will apply immediately.

3.3 Slow Rate Measurement and Actual Transition time

Current slew rate is defined as the change in current over time. A programmable slew rate allows a controlled transition from one load setting to another. The actual transition time is defined as the time for the input to change from 10% to 90%, or 90% to 10% of the programmed current values. The graph below illustrates slew rate measurements.

Between the 10% and 90% region, the slew rate can be measured by observing the steepest slope portion. In case of very large load changes, e.g. from no load to full load, the actual transition time will be larger than the expected (measured) time. For this reason, the firmware allows the user to program slew rate values outside of the specified slew rate ranges. The minimum transition time for all programmable slew rates is also limited in cases where the transition from one setting to another is very small, due to bandwidth limitations of the load.

3.4 Constant Voltage (CV) Mode

In this mode, the electronic load will attempt to sink enough current to control the source voltage to the programmed value.

3.4.1 Configure CV Parameters

There are several parameters that should be set up prior to operating in CV mode. Press **Enter** so that it lights up, then press **Enter** and to access Setup for CV mode. The setup menu will be shown:

- Range** This value will also act as a limit to how much voltage the load can be configured.
- High** This is the current upper limit for the automatic test mode. The system must be operating below the configured value for the test to PASS upon completion. If the DUT operates above this value, the test will FAIL.
- Low** This is the current lower limit for the automatic test mode. The system must be operating below the configured value for the test to PASS upon completion. If the DUT operates below this value, the test will FAIL.

3.5 Constant Power (CW) Mode

In this mode, the electronic load will consume a constant power. When input voltage increases, the input current will decrease, while power ($P = V \cdot I$) will remain the same. This is a sampled system, so the performance is not as fast as in CC and CV modes.

3.5.1 Configure CW Parameters

There are several parameters that should be set up prior to operating in CW mode. Press **Enter** so that it lights up, then press **Enter** and to access "Setup" for CW mode. The setup menu will be shown:

The setup parameters are: Range, High (Voltage limit), and Low (Voltage limit). Use the

Enter keys to select each parameter, and use the numeric keypad to change the value. Press **Enter** to confirm the change.

- Range** This value will also act as a limit the allowed power setting value.
- High** This parameter sets the upper voltage limit for the automatic test mode. If the voltage exceeds this upper limit during the test, the test will fail.
- High** This parameter sets the lower voltage limit for the automatic test mode. If the voltage exceeds this lower limit during the test, the test will fail.

3.6 Constant Resistance (CR) Mode

In this mode, the electronic load approximates a resistor. The current draw is varied by the load according to the input voltage. The performance of this mode is not as fast as in CC or CV mode. This is because it is a sampled system and response to changing input takes a finite amount of time.

3.6.1 Configure CR Parameters

There are several parameters that should be set up prior to operating in CR mode. Press so that it lights up, then press)and to access Setup for CR mode. The setup menu will be shown: The setup parameters are: Range, High (Voltage limit), and Low (Voltage limit). Use the (arrow keys) key to select each parameter, and use the numeric keypad to change the value. Press (enter) to confirm the change.

- Range** This value will also act as a limit the allowed resistance setting value.
- High** This parameter sets the upper voltage limit for the automatic test mode. If the voltage exceeds this upper limit during the test, the test will fail.
- High** This parameter sets the lower voltage limit for the automatic test mode. If the voltage exceeds this lower limit during the test, the test will fail.

Front Panel Operation

The electronic load provides the following modes:

- Constant current (CC) operation mode
- Constant voltage (CV) operation mode
- Constant resistance (CR) operation mode
- Constant power (CW) operation mode

4.1 Local Mode/Remote Mode

The 8500B series can either be operated locally or remotely. When in “Remote” mode, the **RMT** indicator will be lit. When in this mode, the front panel of the load is disabled and all commands are issued via the serial interface. In order to exit “Remote” mode and work in “Local” mode, press the “Local” button. This is the small grey button on the left hand side of the numeric keypad.

4.2 Constant Current (CC) Mode

In this mode, the load will draw the specified current as long as the source is capable of delivering it. The load uses transistors in parallel to implement the load circuit, and as such there are some limits. For example, the load has a finite minimum resistance determined by the R_{dsOn} of the transistors. Next, given the resistance limits, there is a limit to the amount of current that may be drawn for a given voltage. The datasheet shows curves for this limit in the section called “Low Voltage Operation”. Please refer to the datasheet for details for each model.

4.2.1 Configure CC Parameters

There are several parameters that should be setup prior to operating in CC mode. First, enable the “CC” mode of operation by pressing the CC mode key. Next, enter the setup menu by pressing “Shift” and then the “CV” key. Above the “CV” key, “Setup” is written. The following are the available menu items, scroll through them with the up/down arrow keys or by entering a value and pressing enter.

- Range** This defines the maximum allowed current set value. Use this limit to protect against accidentally entering excessive current values either from the keypad or dial.
- High** This is the voltage high limit for the automatic test mode, it does not apply otherwise. During automatic test mode, the device under test (DUT) must be operating below the configured value for the test to PASS upon completion. If the DUT operates above the configured value, the test will FAIL upon completion.
- Low** This parameter refers to the voltage low limit for the automatic test mode. During automatic test mode, the DUT must be operating above the configured value for the test to PASS upon completion. If the DUT operates below the configured value, the test will FAIL upon completion.

- Rise Up/ Fall Down** These parameters define the current slew rate of the load as it changes to a new programmed value. The programmed slew rate takes effect immediately when set, so if the transient or triggered modes are active, it will apply immediately.

4.3 Slow Rate Measurement and Actual Transition time

Current slew rate is defined as the change in current over time. A programmable slew rate allows a controlled transition from one load setting to another. The actual transition time is defined as the time for the input to change from 10% to 90%, or 90% to 10% of the programmed current values. The graph below illustrates slew rate measurements.

Between the 10% and 90% region, the slew rate can be measured by observing the steepest slope portion. In case of very large load changes, e.g. from no load to full load, the actual transition time will be larger than the expected (measured) time. For this reason, the firmware allows the user to program slew rate values outside of the specified slew rate ranges. The minimum transition time for all programmable slew rates is also limited in cases where the transition from one setting to another is very small, due to bandwidth limitations of the load.

4.4 Constant Voltage (CV) Mode

In this mode, the electronic load will attempt to sink enough current to control the source voltage to the programmed value.

4.4.1 Configure CV Parameters

There are several parameters that should be set up prior to operating in CV mode. Press **Enter** so that it lights up, then press **Enter** and to access Setup for CV mode. The setup menu will be shown:

- Range** This value will also act as a limit to how much voltage the load can be configured.
- High** This is the current upper limit for the automatic test mode. The system must be operating below the configured value for the test to PASS upon completion. If the DUT operates above this value, the test will FAIL.
- Low** This is the current lower limit for the automatic test mode. The system must be operating below the configured value for the test to PASS upon completion. If the DUT operates below this value, the test will FAIL.

4.5 Constant Power (CW) Mode

In this mode, the electronic load will consume a constant power. When input voltage increases, the input current will decrease, while power ($P = V \cdot I$) will remain the same. This is a sampled system, so the performance is not as fast as in CC and CV modes.

4.5.1 Configure CW Parameters

There are several parameters that should be set up prior to operating in CW mode. Press **Enter** so that it lights up, then press **Enter** and to access "Setup" for CW mode. The setup menu will be shown:

The setup parameters are: Range, High (Voltage limit), and Low (Voltage limit). Use the

Enter keys to select each parameter, and use the numeric keypad to change the value. Press **Enter** to confirm the change.

- Range** This value will also act as a limit the allowed power setting value.
- High** This parameter sets the upper voltage limit for the automatic test mode. If the voltage exceeds this upper limit during the test, the test will fail.
- High** This parameter sets the lower voltage limit for the automatic test mode. If the voltage exceeds this lower limit during the test, the test will fail.

4.6 Constant Resistance (CR) Mode

In this mode, the electronic load approximates a resistor. The current draw is varied by the load according to the input voltage. The performance of this mode is not as fast as in CC or CV mode. This is because it is a sampled system and response to changing input takes a finite amount of time.

4.6.1 Configure CR Parameters

There are several parameters that should be set up prior to operating in CR mode. Press so that it lights up, then press)and to access Setup for CR mode. The setup menu will be shown: The setup parameters are: Range, High (Voltage limit), and Low (Voltage limit). Use the (arrow keys) key to select each parameter, and use the numeric keypad to change the value. Press (enter) to confirm the change.

- Range** This value will also act as a limit the allowed resistance setting value.
- High** This parameter sets the upper voltage limit for the automatic test mode. If the voltage exceeds this upper limit during the test, the test will fail.
- High** This parameter sets the lower voltage limit for the automatic test mode. If the voltage exceeds this lower limit during the test, the test will fail.

4.7 CR-LED Test Function





The Constant Resistance LED mode roughly simulates a diode characteristic. There are 2 main parameters that are set to accomplish this, the overall resistance and diode threshold voltage (Vd). At input voltages above the threshold (Vd), the resistance of the load decreases. For example, set the Vd to 1.6 V, R to 0.1 and connect a current limited power supply. Set the power supply voltage limit to 5 V, and the current limit to 300 mA. When the input is enabled, the voltage at the input will be approximately 1.6 V, and the current will be 300 mA. This is equivalent to a resistance of 16 Ohms, much larger than the set value of 0.1 Ohms. See **Table 4.1**.

Like in CR mode, a resistance value is also set. This value sets the slope of the diode characteristic. A 3 V VD, 0.1 Ohms, and 1.38 A results in $3V + 0.1\Omega * 1.38A = 3.18V$.

Voltage	Current	Equivalent Load Resistance
1.00	0	infinite
1.58	15mA	105 Ohms
1.62	0.215 A	7.5 Ohms
1.63	0.3	5.4 Ohms
1.69	1 A (limit changed)	1.7 Ohms

Table 4.1 CR Mode example

4.7.1 Setup



Enable CR-LED mode via  + . Use the arrow keys to move the flashing value "ON". Press  to confirm and move on. The next screen shows the VD value. Enter the desired threshold voltage and press . CR LED mode is now setup.

Note: As in CR mode, the control system speed can make loading switching power supplies problematic.

4.7.2 External Triggering

EXTERNAL: An external trigger is a TTL low signal applied to the Trigger connection on the back panel. This TTL signal must last for more than 5 ms. A trigger applied to this input is used to change settings (voltage, current, resistance), toggle between settings in transient- toggle mode, or generate a pulse in pulse mode.

Operation to select the trigger source as external:

[] + [8] (system) to enter the menu, use [(right/left)] to select TRIGGER, press , and then select EXTERNAL. Press  to exit the menu.

Rear Panel Functions

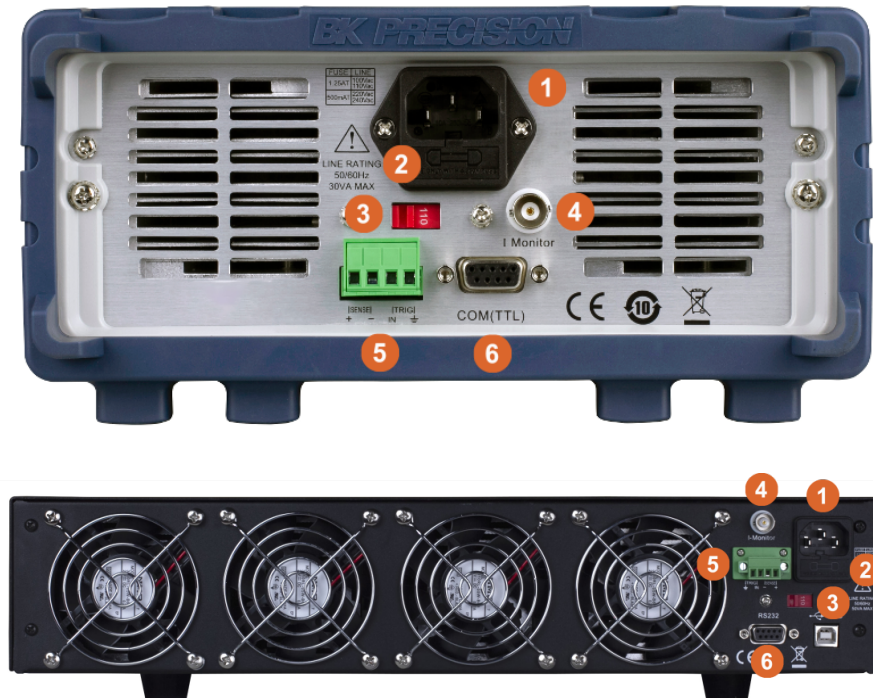

Item	Description
1	Power Input
2	Fuse Holder
3	AC Input Voltage Selection
4	Current Monitor Output
5	Remote Sense/Trigger Input
6	Remote Interface

Figure 5.1 Rear Panel

5.1 Remote Sensing

Remote sensing is used to counteract the effect of lead resistance. For example, if you connect a power supply to the DC Load, the voltage at the power supply's terminals will not be the same as the voltage at the DC Load's terminals if there is a current flowing because of the finite resistance from the wires. Using remote sensing, you can sense the voltage at the power supply's terminals, effectively removing the effect of the voltage drop in the connection wire. Connect the "+" and "-" terminals at the rear of the unit to the power source.

Note:To reduce interference, twist the sense lines together and run together with the wires connecting the load to the source.

Note:When using remote sensing, the power displayed by the instrument includes both the power dissipated inside the instrument and the power dissipated in the leads from the power supply to the DC Load's input terminals.

1. Press **Shift** + **Config** (9) to enter the configuration menu.
2. Use the arrow keys to navigate to the “SENSE” menu item. Press **Enter** to enter the menu.
3. Use the arrow keys to select the desired value “ON, or OFF” and press **Enter** to confirm the setting.
4. When active, the “Sense” indicator will show on the display.

5.2 External Triggering

An external trigger is a TTL low signal applied to the Trigger connection on the back panel. This TTL signal must last for more than 5 ms. A trigger applied to this input can be used to change settings (voltage, current, resistance), toggle between settings in transient-toggle mode, or generate a pulse in pulse mode.

1. Press **Shift** + **Sys** (8).
2. Use the arrow keys or the knob to navigate to the “TRIGGER” menu item.
3. Select “EXTERNAL” and press **Enter** to confirm the setting.

5.3 Current Monitoring (I Monitor)

The current monitor output, the bnc connector, outputs a scaled voltage relative to the current flowing. The relationship is $V_{out} = 10V * \frac{curr}{max}$. For example, the 8542B maximum current is 30 A. When a current of 1 A is flowing, the current monitor output will be $10V * \frac{1}{30} = 333mV$.

Note: The output accuracy is approximate. Verify the scaling relationship for each unit.

5.3.1 Remote Sensing

Remote sensing is used to counteract the effect of lead resistance. For example, if you connect a power supply to the DC Load, the voltage at the power supply’s terminals will not be the same as the voltage at the DC Load’s terminals if there is a current flowing because of the finite resistance from the wires. Using remote sensing, you can sense the voltage at the power supply’s terminals, effectively removing the effect of the voltage drop in the connection wire.

When using remote sensing, the power displayed by the instrument includes both the power dissipated inside the instrument and the power dissipated in the leads from the power supply to the DC Load’s input terminals.

Steps to enable remote sensing in the menu:

1. Press **Shift** + [9] key into the menu
2. VFD displays >, press [Enter] key to confirm
3. Press [(right/left)] to choose >, press [Enter] key to confirm
4. Press [(right/left)] to choose >, press [Enter] key to confirm, then remote sense function has been set, and VFD display indicator.

Remote Sensing: SENSE (+) and SENSE (–) are the remote sensing inputs. By eliminating the effect of the inevitable voltage drop in the DC load leads, remote sensing provides greater accuracy by allowing the DC load to regulate directly at the source’s output terminals.

Wiring Diagram for Remote Sensing:



5.3.2 Current Monitoring (I Monitor)

Current monitoring terminal will output 0-10V analog signal to corresponding to 0 to full range of input current. You can connect an external voltmeter or an oscilloscope to display the input current’s changing

Advanced Functions

In addition to the 4 general modes of operation, there are a number of other more application specific functions. These functions enable more advanced testing.

6.1 Short Operation

The electronic load can simulate a short circuit at its input. During front panel operation, press  +  to switch the short on/off state. Short operation will not affect the present setting. When turning off the short state, the load returns to the original set state. The actual value of the electronic load in short operation depends on the mode and range that is active when the short is turned on. In CC or CR mode, the maximum short current is typically 110% of the current range. In CV mode, short means setting the load's constant voltage to be 0 V. In short operation mode, you can measure the maximum short current (A_{max}) or DC current (ADC) of the power source to be measured. You can set this function via the Configuration menu.

6.2 Short-circuit Analog Function

Short circuit simulation and short circuit current measurement: you may press [Shift] + [1] button to emulate a short state. It can be used to check whether the tested instrument's short protection is available.

In short mode, the DC load will draw maximum current from the DC supply in any of the four operation modes (CC, CV, CW or CR). In CC, CV, or CR mode, you may press [**Shift**] + [**1**] to stop short. The DC load will return to its previous operation. However, in CW mode, the short current will continue to be drawn. To stop the short, you must press the [**On/Off**] key after you press [**Shift**] + [**1**]. When emulating a Short in CC, CW or CR mode, the maximum allowable short current is equal to the 110% of current range. Under CV mode, short circuit current is equivalent to that constant voltage value of load is 0 V.

6.3 Transient Operation

Transient mode periodically switches between two load levels. There are three different transient modes:

- Continuous** Generates a respective pulse stream that toggles between two load levels.
- Pulse** Generates a load change that returns to its original state after some time period.
- Toggle** Generates a repetitive pulse stream that toggles between two load levels. It is similar to continuous mode except that the transient points are controlled by explicit triggers instead of an internal transient generator.

Depending on the selected **Trigger Source** from within the "SYSTEM" menu, the operation may start immediately. To run the transient operation, first press to enable the input. Then, send a trigger to start the operation. If **Trigger Source** is set to "Manual", press and then (or press) to send a trigger. Refer to "Configure Trigger Source" in section "SYSTEM Menu" to configure the **Trigger Source**.

Note: The number next to "TRAN" on display will count each transition. It can only count up to 65535 transitions, after which it will reset to 0 and start over.

To disable transient operation, first press to disable the input. Then, press and (or press). Select "Off" and press to confirm.

1. First, select the load's mode of operation, which will determine which type of transient operation will be configured. Press **Mode** to select between CC, CV, CW, or CR mode. Verify the selection by the backlight behind its corresponding button, which will be lit when selected.
2. Enable transient mode from the "Tran" menu. This is accessed via "**Mode** + **Tran**".
3. Select the transient mode "Continuous", "Pulse", or "Toggle". Press **Enter**.

6.3.1 CC Mode

In Constant Current mode, the configurable parameters are the following:

- Mode** Continuous, pulse, or toggle
- Up** The rising edge current slew rate in A/us.
- Down** The falling edge slew rate in A/us.
- Level A, Level B** The 2 current levels applied.

In Continuous mode, the following are also set:

- Freq** The transient cycle frequency.
- Duty** The duty cycle or percentage of time the load will be at either level (A/B). The percentage defines the ratio of the B level to the cycle. So for 75% and 1 Hz, the B level will be on for 750 ms and the A level 250 ms.

In Pulse Mode, the following is also set:

- Width** The transient frequency

6.3.2 CV, CW, and CR modes

In Constant Voltage, Power and Resistance modes, the configurable parameters are the following:

- Mode** Continuous, pulse, or toggle
- Level A, Level B** The 2 levels.

In Continuous mode, the following are also set:

- Freq** The transient cycle frequency.
- Duty** The duty cycle or percentage of time the load will be at either level (A/B). The percentage defines the ratio of the B level to the cycle. So for 75% and 1 Hz, the B level will be on for 750 ms and the A level 250 ms.

In Pulse Mode, the following is also set:

- Width** The transient frequency

6.4 LIST Operation

List mode allows you to generate a complex current sequence. Moreover, the mode change can be synchronized with an internal or external signal to accomplish dynamic and precise test. A list file includes following parameters: file name, step count (range 2-84), step width (0.00005 s - 3600 s), step value and slope. The list file is saved in memory for later recall. There is storage for up to 7 list programs. In list mode, the load starts the list following a trigger signal. The list will continue run to completion or until another trigger signal is received.

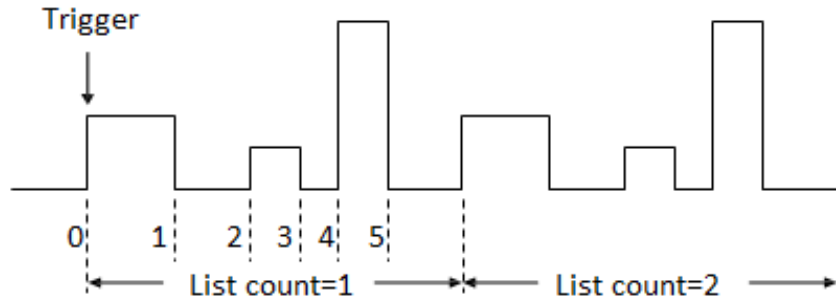

Figure 6.1 List Mode Current Waveform

6.4.1 Configure List

Lists are run exclusively from internal memory only. As in other menus, an active field is denoted by an underline cursor or flashing. To enter a list into memory, complete the following:

1. Press **Shift** + **List** (3).
2. Set the first field in the menu to “OFF”. If the field is set to “ON”, press **Enter** to change the value to “OFF”.
3. Move the selected field via the **Left/Right** buttons to the “EDIT” (shown as EDI) field and press **Enter** to start editing a List. If nothing happens, ensure the first field is set to “OFF”.
4. Set the current range.
5. Set the number of steps in the list. This is a value between 2 and 84.
6. Set the first step’s current, slew rate, and step time.
7. The next step in the list will prompt automatically. Enter the values for each step in the same way.
8. When each step is entered, the system prompts for the number of times to run the sequence. A 1 in this field means the sequence will run only once.
9. Enter the list file location to store the newly created list.

The list is now saved and may be recalled.

6.4.2 Run List

1. Select the list to run:
 1. From the “List” menu, select “CALL” and press **Enter**. The load prompts for the list to recall (1 through 7).
 2. Enter the list number and press **Enter** to recall it.
2. Enable List mode by selecting the “Off” menu item and press **Enter**. The “OFF” changes to “ON” and the “Trig” indicator lights.

- Use the **Esc** button to go back to the normal display. The load is now ready and waiting for a trigger.
- Press **On/Off** to enable the input, and send a trigger to start the list program.
If Trigger Source is set to Manual, press **Shift** + **Trig** to send a trigger. See Section ?? for details about triggers.

Note: The number next to LIST on the display shows the current running step number. When the list ends, it will change back to “0”.

Note: At the end of a list operation, the load’s input remains on the settings of the last step value.

6.4.3 Disable List Mode

- Disable the input via the **On/Off** or remote command.
- Press **Shift** + **List** (3)
- Select the “ON” item and press **Enter** to change the value to confirm. The “Trig” indicator will disappear.

6.5 Battery Test Function

The 8500B series products include battery test capabilities. This function provides a constant current load. The test records the time, and charge consumed in Amp-hours. Three independent conditions are available to customize the test. These are voltage, charge (Ah), and time.

Stop conditions are not optional. If one of the conditions is not required for a test, then the value should be set so that it will not trigger. For example, if the capacity is unimportant to the test, set the value to maximum (999.999 Ah).

The run the battery test function a configuration is loaded into memory, the battery test mode is then enabled, and finally the mode is started by a trigger signal.

6.5.1 Test Configuration

To configure a battery test, the “RUNMODE” must be set to “NORMAL”. See Section ?? for details.

- Press **Shift** + **Batt** (5)
- The battery test parameters menu will open.
- Set the parameters of the test:

Range The maximum current allowed. Set to a value equal to or higher than the desired discharge current.

Current The discharge current for the test.

Stop Voltage The lower limit voltage for the battery.

Stop Cap (Capacity) The maximum capacity to discharge. For example, 50% discharge of a 10 Ah battery, this would be 5 Ah.

Stop Timer The maximum test time.

- When the settings are entered, the last step is to set the memory location. Set the value (1 - 10) and press **Enter** to complete the configuration entry.

6.5.2 Enable Battery Test Mode

- Press **Shift** + **Sys** (8) to enter the system menu.
- Use the **Left/Right** keys to navigate to the 'RUNMODE' setting.
- Press **Enter** to enter the setting menu.
- Use the **Left/Right** to scroll through the different settings and select "BATTERY".
- After setting the mode, exit the menu using the **Esc**.
Battery test mode is now enabled.

6.5.3 Recall Battery File

Press **Shift** + **Enter** to select program file, the panel displays "RECALL BATTERY 1". Enter the file name (1-10) and press **Enter** button.

6.5.4 Start Battery Test

With the battery mode enabled, the load will work in a limited CC mode. If the battery test conditions are met, the input may be enabled, and the battery mode test current will be drawn. If the limits are not met, the input will automatically turn off.

To start a battery test, send a trigger to the load. In manual trigger mode, press the **Trig** button. The battery test will automatically terminate when the stop conditions are met.

6.6 Program Mode



















Test files are a generalization of lists. They generate a sequence of tests using different modes, mode parameters, and durations. They are useful for executing a set of tests on a device, then displaying pass/fail results. Up to 10 groups of test files can be defined. Each file contains 10 steps.

6.6.1 Example: Small AC/DC power supply test



Suppose we have a small AC to DC power supply (a "wall-wart") and we want to set up an acceptance test for a number of these devices.

- Set the DC load to constant current mode to draw the rated current of 1.2A from the device. The output voltage of the device at the rated current must be between 4.4V and 4.6V.
- Set the DC load to constant voltage 3V. The output current of the device is between 2A and 3A.
- When the device operates into a short, the supplied current must be larger than 3.0 A.

Steps Operation VFD Display

1. Press  +  (Prog).
ACTIVE =0987654321
2. Press  ,  and press enter to confirm.
ACTIVE =0987654YYY
3. Select the step that should pause during the test. When paused, press [downarrow] continue the test.
PAUSE=NNNNNNN32Y
4. Step 3 short circuit testing, press , and press  to confirm.
SHORT =NNNNNNNY21
5. Set Ton for the first step if you want to load on for 2S, press , and then press  to confirm. T-on range 0-60S.
SEQ01 ON =2S
6. Set Toff for the first step, if you want to load off 2S, press , and then press  to confirm.
SEQ01 OFF =2S
7. Set testing delay time, 0-60S e.g. 1S, press [1].
SEQ01 P/F =1S
8. Set Ton for the second step, if you want to load 2S, press , then press Enter to confirm
SEQ02 ON =2S
9. Set Toff of the second step, if you need 2S, press , and then press  to confirm.
SEQ02 OFF =2S
10. Set testing delay time of the second step, e.g. 1S, press 
SEQ02 P/F =1S
11. Set Ton for the third step, if you want to load on 3S, press , then press  to confirm
SEQ03 ON =3S
12. Set Toff of the third step, if you need 2S, press , then press  to confirm.
SEQ03 OFF =2S
13. Set testing delay time of the third step, e.g. 2S, press  .
SEQ03 P/F =2S
14. set start voltage. Please refer to “function of auto start voltage”.
AUTO START=0.000V
15. Set stop condition
STOP COMP FAILURE

Function of Auto Start Voltage:

1. Auto start=0V.
Auto test file start to run when receive a trigger signal by pressing  +  or providing a external trigger signal.
images/trigButton
2. Auto start is not equal to 0V (Take 2V as an example)
In this condition the user connects the charger to the input terminals of E-load. The unit can auto start to run test file when detect a rising edge from 0-2V. Auto start voltage is not suggested to be a big value. 2V is suitable.
file:
images/trigButton
unknown

Ton, Toff and Tpf (P/F) Relation:

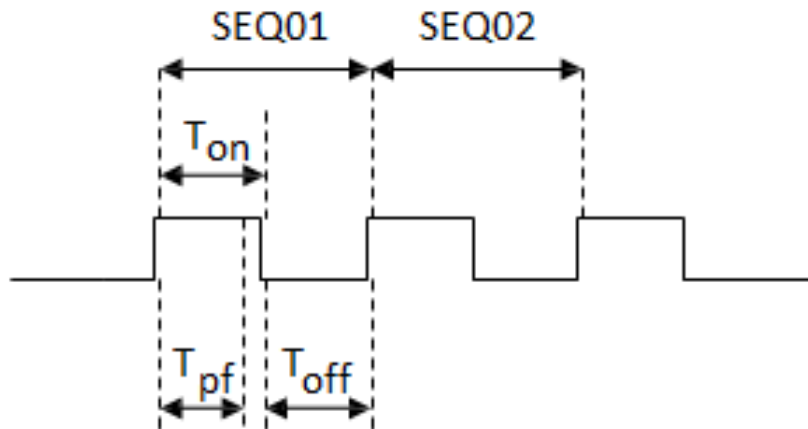

Tpf the delay time for a step

15. Set stop conditions: **COMP** means stop test when all the steps are completed, **FAILURE** means stop test when the testing fails. Press **Enter** to confirm.
STOP COMP FAILURE

16. Select the test file to link if you'd like to. The linked file must be saved before. 0 stands for not linking to other files.
Press **Enter** key to confirm.
CHAIN PROGRAM =0(0-10)

Program/Save	Locations									
PROGRAM Sequence 1	1	2	3	4	5	6	7	8	9	10
Save Group	1	2	3	4	5	6	7	8	9	10
PROGRAM Sequence 2	1	2	3	4	5	6	7	8	9	10
Save Group	11	12	13	14	15	16	17	18	19	20
PROGRAM Sequence 10	1	2	3	4	5	6	7	8	9	10
Save Group	91	92	93	94	95	96	97	98	99	100

17. Save the edited files in EEPROM, you can save up to 10 groups of files, e.g please press **Short 1** to save the edited file in group 1, and then press **Enter** to confirm.
SAVE PROGRAM =1(1-10)

18. Select a operation mode and then press **Shift + [CV]** to set related parameters
10.0000V 0.0000A
0.00W CC=1.000A

19. Edit the three steps of the test file, details refer to below procedure. After all the steps are set , Press **Esc** to exit setup, and then press **Shift + Save 4** to save.
You need to recall the test file before running it

Set the steps of a test file in the example

CC Mode, 1.2A, Voltage Range 4.4V-4.6V

1. Press [[Shift)+[CC] button and then [CV] (Setup) to enter the setting interface.
RANGE=30.000A
CC
2. Set the current range press **Enter** to confirm.
RANGE =1.2A CC
3. set the upper limit of voltage, press **Enter** to confirm.
HIGH=4.6V
CC
4. Set the lower limit of voltage, press **Enter** to confirm.
LOW=4.4V
CC
5. Set the rise speed of current, press **Enter** to confirm.
UP=1A/uS
CC
6. Set the fall speed of current, press **Enter** to confirm.
DOWN=1A/uS
CC
7. Finish the setup
10.0000V 0.000A
0.00W CC=0.000A





CV Mode, 3V, Current Range 2A 3A

1. Press [CV] button press to set related ^{Shift} **+** [parameters]
RANGE=120.00V
2. Set the voltage range press **Enter** to confirm.
RANGE=3.00V
3. set the upper limit of current press **Enter** to confirm.
HIGH=3A
4. Set the lower limit of current press **Enter** to confirm.
LOW=2A
5. Finish the setup
10.0000V 0.000A
0.00W CV=10V





The CW and CR is set as the same way:

CW Mode

Steps Operation VFD Display



1. Press [CW] button press to set related ^{Shift} +[parameters]
RANGE=150.00W
CV
2. Set the power range press  to confirm.
RANGE =1.00W
3. Set the upper limit of voltage press  to confirm.
HIGH=120.00V
4. Set the lower limit of voltage press  to confirm.
LOW=0.000V
5. Finish the setup
10.0000V 0.000A
0.00W CW=1.00W

CR Mode



1. Press [CR] button, press [^{Shift} +[CV] (Setup) to set related paramters.
RANGE=7500.0Ω
2. Set the resistance range press  to confirm.
RANGE=2Ω
3. set the upper limit of voltage press  to confirm.
HIGH=120.0V
4. Set the lower limit of voltage press  to confirm.
LOW=0.000V
5. Finish the setup.
10.0000V 0.000A
0.00W CR=2.000Ω

Go into Autotest Mode

Operation Display on Front Pannel

1. Press ^{Shift} +^{Sys}  (system) to enter the system menu.
0.0000V 0.000A
POWER-ON BUZZER
2. Press right key, select RUNMODE and confirm with  button.
0.0000V 0.000A RUN <NORMAL>
3. Press direction key to select OCP_TESTPress Enter to confirm.
0.0000V 0.000A RUN <PROG_TEST>
4. Press [Esc] button to leave the menu.
0.0000V 0.000A
P01

According to the following steps to escape OPP mode:



Press  +  (system) — “RUNMODE” —  — select “NORMAL” mode — .

6.6.2 Start Auto Test File

Press  to provide a signal to start auto test file. The discharging process will be auto terminated when stop conditions are reached.

6.6.3 Recall Test File

Press  +  button to select program file the panel displays “RECALL PROGRAM= 1” Enter the file name(1-10)press  button to confirm.

















If you need a pause, press  +  (pause). Press  can continue the test.

6.7 Measurement of Voltage Rise Time

The 8500B series electronic load is provided with special voltage rise/drop time measurement function. This function gives a simple analog of voltage rise/drop speed of oscilloscope test power.

Operation methods:

1 Set initial Voltage and Final Voltage

1. Press  +  keys to enter configuration menu. Press Right key. Select “Measure” and press  key.
2. Press  to select “TimeV1”. Press  key. Press numeric keys to set initial voltage value and press  key.
3. Press  to select “TimeV2”. Press  key. Press numeric keys to set final voltage value and press  key.
4. Press  to exit setting. Start timer function
5. Press  +  keys to enter system menu. Press Right key till “Displ” flicks and press  key.
6. Press  key to select “On”. Start timer function and press  key.
7. Press  to exit setting.
8. VFD second line will display time 0.0000S between power value and set value.
OFF CC
v-0.0002a 0.0001V 0.0002A
0.00W 0.0000S CC=0.000A

Measurement of Rise Time

9. Connect DC power to be tested to the input terminal of the electronic load. The power is set with a value that is higher than the set final voltage value. Keep power output in OFF status.
10. Set a constant current value on the load and open the load input.



11. Open power output.
12. The electronic load timer starts timing. After ending, time will keep stable, which is rise time of voltage.
13. Close the power output. The electronic load VFD will display voltage drop time.

6.8 Ripple Function

The 8500B series DC electronic loads have test ripple function. You can read ripple voltage and ripple current by sending instructions. See the programming manual for more information.

Configuration Functions

7.1 VON Function

The DC load can be set to only turn on if the voltage is above a set value (VON set) under configure menu by pressing  . There are two types of VON function: “Living” and “Latch”. The following will have detailed description for the two types.

NOTE

VON set is used to ensure an electronic system under test will not have power applied unless the supply voltage is above a certain value. If you have no such testing request, do not set this value arbitrarily. If your instrument can not work normally, for example, set CC=1 A, after turn on the input while the current is still 0 A instead of setting value 1 A, then you should check VON set firstly. If VON set is not 0 V, then please modify to 0 V.

VON LIVING MODE In Living mode, when power is applied to the DC load, the voltage must rise above VON setting before the load draws current from the source. If the voltage below VON setting on the load's terminals, the load will turn off input.

VON LATCH MODE In Latch mode, as before, the load will turn on only when the voltage exceed VON setting, but once on, it will now stay on, even if the voltage drops to zero.

7.2 Menu Operation

How to Navigate the Menu

Before using the instrument, it is important to be familiarized with its menu structure and learn how to view or change settings and parameters. Follow the steps below to guide you in selecting menu options.

1. Follow the instructions above to access the System or Config menu.
2. The selected item will be blinking. Use and) keys to move through the menu selections.
3. When the desired menu section is blinking, press to access its menu settings.
4. Below is the display when SYSTEM is selected.

7.3 System Menu



Initialize Power-On:



1. The selected item will be blinking. Use) keys to move through the menu items. When there is a on the right side of the display, that means there are more menu items available to select from. Similarly, a will appear on the left side of the display when there are menu items to the left
2. There may be parameters or options to select within each menu item. Follow the same instructions as described in the previous steps to select them. Some settings can be changed by using) arrow keys. To save changes to a setting, press .
3. To exit the menu at any time, press .

7.4 Menu Options



Most settings and parameters can be configured from the built-in menu systems of the instrument. There are two main menus: System and Config.



7.5 System Menu (System)

Press  +  to enter the system menu.

POWER-ON : POWER-ON Power on state of instrument	
RST (default)	Do not remember state in SAVE 0. Customer can save a often used data in SAVE 0 to recall when power on the DC load next time.
SAV0	Remember state in SAVE 0
BUZZER : BUZZER	
ON (default)	Enable audible beep when key is pressed
OFF	No sound when key is pressed
KNOB : KNOB	
UPDATE (default)	The value modified with knob during operation will be saved after load is off. For example; the DC load is set to 1 A by press  to turn on the input. Then increase the setting value to 2 A with knob. When customer turn off load and run on again, the setting value changes to 2 A.
OLD	As explained above, after the DC load is turned on again, the setting value is 1 A instead of 2 A changed with knob.
TRIGGER : SOURCE	Set trigger mode
MANUAL (Def)	Triggered from the  +  key
EXTERNAL	Triggered from a TTL high signal at the trigger connector on rear panel
BUS	Triggered from a serial bus command 5 AH
HOLD	Receiving a command 9 DH
MEMORY : MEMORY	Recall the pre-stored data
GROUP=0	0: indicates 1-10 group; "1": indicates 11-20 group, by parity of reasoning
DISPLAY : DISP-TIMER	Timer function
ON	Enable timer function
OFF (default)	Disable timer function
RS-232 : RS-232	
4800_8 N 1	Baudrate 4800, data bit 8, none parity, stop bit 1
9600_8 N 1	Baudrate 9600, data bit 8, none parity, stop bit 1
19200_8 N 1	Baudrate 19200, data bit 8, none parity, stop bit 1
38400_8 N 1	Baudrate 38400, data bit 8, none parity, stop bit 1
PROTOCOL : SCPI	Select SCPI protocol
FRAME	Select FRAME protocol
ADDRESS : ADDRESS= 0	Set the instrument's address (0-31)
RUNMODE : RUN	Running mode at power on
NORMAL	Normal mode
BATTERY	Default in battery test mode at power on
PROG_TEST	Default in autotest mode at power on
OCP_TEST	Default in OCP test mode at power on
OPP_TEST	Default in OPP test mode at power on
DEFAULT : DEFAULT	
NO	Do not return instrument to factory default settings.
YES	Return instrument to factory default settings

7.6 Config Menu

Press  +  to enter the menus.

PROTECT - Max-P	Set hardware power protection
MAX POWER=150.00 W	Set hardware OPP value
A-LIMIT	Set software current protecting state
A-LIMIT	
ON	Enable software over current protection function
A-LIM POIN=30.00 0 A	Set the software OCP level
A-LIM DELAY= 3 S	Set the OCP delay time
OFF	Disable the software OCP function
P- LIMIT	Set software power protecting state.
P-LIM POIN=150.0 0 W	Set the software OPP level.
P-LIM DELAY= 3 S	Set the OPP delay time.
TIMER	Set load on timer
LOAD-TIMER	
ON	Enable load-on timer
LOAD-TIMER=10.0 S	Set the load on time (0.1 S-9999.9 S)
OFF	Disable load on timer
MEASURE : V-RANGE	Voltage auto-range function
V-RANGE	
ON	Enable voltage auto range function
OFF	Disable voltage auto range function
FILTER	Set the filter parameter
FILTER COUNT = 2^14	Filter count set, range 2-16
TIME-V1	
TIME-VOLT1=0.000 V	Set the start time, to measure the voltage rise/fall time.
TIME-V2	
TIME-VOLT2=120.00 V	Set the end time, to measure the voltage rise/fall time
CR-LED ::: CR-LED	Imitate LED (in CR mode)
ON	Open the function (in CR mode, press  +  to set Vd value)
OFF	Disable the function
SENSE ::: REM- SENSE	Remote sense function
ON	Enable remote sense function
OFF	Disable remote sense function
VON ::: VON	Set the load's VON point
LIVING	VON point living state
VON POINT = 0.10 V	Set the VON value
LATCH	VON point latch state, ON /OFF
VON POINT = 0.10 V	Set the VON value
RESET ::: RESET	Reset the config menu
NO	Do not reset
YES	Reset

System Settings

8.1 Run Recall Edit

1. Select “Edit” and press . Enter a value using the numeric keypad or rotary knob for “Voltage On Level”. The value must be within the maximum input limits of the load. Press to continue.
2. Enter a value for “Voltage On Delay”. This is set between 0.00s and 99.99s. Then press to continue.
1. Follow the same steps for “Current Range”. The value must be within the maximum input limits of the load. Press to continue.
2. Set the “Start Power”. The value must be within the maximum input limits of the load. Press to continue.
3. Follow the same steps for “Step Power” and “End Power”. Press after each settings to continue.
4. Enter a value for “OPP Voltage” and press to continue.
5. Enter a value for “Max Trip Power”, and then “Min Trip Power”. Press after each settings to continue.
1. The load will prompt to “Save OPP File”. Select a number between 1 and 5. Then press to save all settings to the selected location.

Note: At any time when configuring any parameters for the test, you can press the) key to select the previous parameter to edit.

8.2 To recall the settings

1. Press to enter the “OPP Test” menu.
2. Select “Recall” and press .
3. Use the keypad or knob to select the saved location number and press . All settings will be recalled when selecting “Edit” from the “OPP Test” menu.

8.3 To run the OPP test

1. Recall the settings from memory by following the steps above.
2. From the “OPP Test” menu, select “Run” and press . The display will show the following:
OFF CC
v-0.000a 10.000V 0.000A
0.00W 0.00W Stop
3. Press) to start the test. When the test is running, “Run” will be indicated in place of “Stop”. When the test ends, either “Pass” or “Fault” will appear next to “Stop”.
4. To stop the test at any time, press).

8.4 Key Lock

The front panel keys are locked to prevent unwanted changes to output settings and instrument configurations. Follow the steps below to enable/disable key lock.

1. Press) and then (). A "*" indicator will light up on the display, indicating that the front panel keys are lock. At this point, all keys are disabled except for the Lock function.
2. To unlock the keys again, press) and then ()again. The "*" indicator will disappear and all keys will be enabled.

8.5 Restore Factory Default Settings

All instrument settings are reset back to their factory default values by doing the following:

Note: Restoring the instrument to factory default will change all current instrument settings and parameters back to their default values.

1. From the "SYSTEM" menu, select "Initialize" and press **Enter**.
2. The following screen will display. Select "Yes" to restore default settings, or "No" to cancel.

Table 8.1 lists some of the factory default settings.

Item	Default Setting
Communication	RS232 (4800, 8, N, 1, NONE)
Display On Timer	Off
Trigger Source	Manual
Protocol	SCPI
Von	Latch
A-Limit	Off
Memory	Group 0
Power-On	RST
Buzzer	On
Load On Knob	Update
On Timer	Off
Voltage Auto Range	On
Averaging Filter	2 ¹⁴
Remote Sense	Off
External Program	Off

Table 8.1 Factory Default Settings

8.5.1 Configure Power-On State

The initial Power-On state of the load is configured by following the steps below:

1. From the "SYSTEM" menu, select "Power-On" and press **Enter**.
2. There are two options:

Rst(Def) – Factory Default.

"Sav0" – Settings before last power up. Recalls the settings saved to "0" memory location.

1. Select the settings you want during power up, and press **Enter** to save changes.
2. To exit the menu at any time, press **Esc** twice.

8.5.2 Load On Knob

This setting controls the behavior of the knob.

1. From the “SYSTEM” menu, select “Knob” and press **Enter** .

2. There are two options:

Update(default) Real time update.

Old No update (when turning load ON/OFF, original value before use of rotary knob will be set)

3. Select the settings you want during power up and press **Enter** to save changes.

4. To exit the menu at any time, press **Esc** twice.

8.5.3 Configure Trigger Source

The trigger function is used to initiate the start of a program in list mode and also as a toggle for transient mode. The trigger source is set so that users can send a trigger from the front panel, through a remote command via remote interface or through the external trigger input in the rear panel. Follow the steps below to configure the trigger mode:

1. From the “SYSTEM” menu, browse and select “Trigger” and press **Enter** .

Manual(Def) Manual trigger. Front panel trigger button is used to send a trigger (press and (or press ) to send trigger).

External External trigger. Trigger is sent by connecting the “Trig” input and the ground input together in the rear panel. A TTL signal may also be used as a trigger signal when sent across these terminals. If using a TTL signal, the unit triggers off of a falling edge. Signal pulse width must be $> 10 \mu\text{s}$.

Hold Hold trigger. This behaves similarly to “Bus” trigger, however the “TRIG:IMM” command is used instead.

Bus Bus trigger. Remote commands “*TRG” and “TRIG:IMM” can both be used to send a trigger. With “Bus” trigger, multiple devices are triggered at the same time when communicating via GPIB interface.

Timer Timer trigger. A trigger will be sent periodically based on the set time. Time is set from 0.01 s to 9999.99 s.

2. Select one of the options. For timer trigger, use the numeric keypad or rotary knob to set the time.

3. To exit the menu at any time, press twice.

8.5.4 Save/Recall Instrument Settings

The instrument can save up to 100 instrument settings in non-volatile memory. Memory is allocated in 10 different storage groups (group 0 to 9), and each group has 10 memory locations to store settings (0 to 9). These memory locations are referenced by numbers 1 – 100. When saving an instrument setting, numbers 1 to 100 is selected. However, when recalling an instrument setting, the group must be selected first and then the numeric keypad buttons 1 through 9 and 0, which refers to the 10 locations of the selected storage group. Below is the table illustrating the storage group and allocated memory locations.

Storage Group	Memory locations
0	1 – 10
1	11 – 20
2	21 – 30
3	31 – 40
4	41 – 50
5	51 – 60
6	61 – 70
7	71 – 80
8	81 – 90
9	91 - 100

When recalling settings, each of the numeric keypad numbers corresponds to the memory locations based on the storage group selected according to the table above. For storage group 0, recalling memory location 1 is done by pressing ; location 2 is done by pressing , and so on. Memory location 10 is recalled by pressing . For storage group 1, recalling memory location 11 by pressing , location 12 by pressing , and so on.

Example:

Settings are saved to memory location 60. To recall those settings, set storage group to 5 from the menu, then press recall and the number .

8.5.5 Select Storage Group

1. From the “SYSTEM” menu, browse and select “Memory” and press . The following screen will appear.
1. Use the current adjust knob or the numeric keypad to enter the storage group. Select between “0 – 9”. Press **Enter** to save selection.
2. To exit the menu at any time, press **Esc** twice.



NOTE: The storage group setting also affects the automatic test function of the load. Refer to “Automatic Test Function” for more details.

8.5.6 Save Settings

1. Set up all the instrument settings that you want to save.
2. Then, press) and . The display will show the following:
3. Use the current adjust knob or the numeric keypad to enter the memory location in which to store current instrument settings. Select between “0 – 100”. Press **Enter** to save to the selection location.

NOTE: The “0” memory location is reserved for storing instrument settings last configured before power-off and is used only for power-on state configuration only.

8.5.7 Recall Settings



1. First, consider the memory locations you want to recall from. As they are grouped together, select the appropriate storage group from the “SYSTEM” menu first by following the instructions in previous section.
2. Once selected, press (b- ) and  (or press (recall)) and it will light up to indicate the instrument is in “Recall” mode.
3. Use the keypad numbers to recall the settings from the corresponding memory location referenced by the storage group selected in Step 1.
4. Once entered, the saved settings at the location will be immediately recalled.

Note: When in Recall mode, users can recall settings from different locations without having to press additional keys each time. For example, you can press 1 to recall settings in location one, and then press 5 to recall settings in location 5 on the fly.

1. To exit “Recall” mode, press .



8.5.8 Display Input On Timer

The instrument has an internal timer that counts how long the input has been enabled (ON). Follow the steps below to enable the timer display.

1. From the “SYSTEM” menu, browse and select “Displ” and press  . The following screen will appear.
1. Select “On” to enable the timer, and “Off (default)” to disable. Press  to confirm.
2. Press  twice to exit the menu. The timer will now be displayed like the following:
4. When input is enabled (ON), the timer will start counting the time. When input is disabled (OFF), the timer will reset itself to a value close to 0 seconds.

8.5.9 Remote Interface Setup

The instrument has RS232, USBTMC, and GPIB remote interfaces available for remote communication. Follow the steps below to select and configure each interface.

Note: The “RMT” indicator will appear on display when the instrument is successfully connected to a PC remotely through any remote interface. Keys on the front panel will be locked until the instrument is in LOCAL mode. To return to LOCAL mode from the front panel, press  (and then ) . The “RMT” indicator will disappear when the instrument is in LOCAL mode.

From the “SYSTEM” menu, browse and select “Communication” and press  . The following screen will appear.

8.5.10 RS-232

Follow the steps below to configure the instrument for RS-232 operation:

1. Select “RS-232” and press to set to RS-232 for remote communication. The following display will be shown:
 1. “” is the baud rate; “8” is the data bits; “N” is the parity; “1” is the stop bit; “Addr...” is for address.
 2. Use the) keys to select between each serial settings, and use) keys to change the settings.
1. The following setting options that are used: Baudrate: 4800, 9600, 19200, 38400, 57600, 115200* Data bits: 8

Parity: N (None), E (Even), O (Odd)

Stop bit: 1

Flow control: NONE, CTS/RTS, XON/XOFF

Note: The default is 4800, 8, N, 1, NONE.

*Setting the baud rate to 115200 may provide unstable results during remote communication. Select a lower baud rate if communication errors occur.

1. All serial settings must match with the settings configured on the PC in order for communication to link successfully.

8.5.11 CONFIG Menu

All setup procedures and settings explained in this section are accessed from the CONFIG menu. To access this menu, press) and (). The following screen will show:

8.5.11.1 Von Operation

The Von voltage value is set to control the voltage turn on state for the electronic load. When the input voltage exceeds the Von voltage value, the electronic load's input state turns on.

This function can protect a DUT when its voltage goes below a specified level. For example, when testing a power supply's discharge characteristics, you can set the Von voltage level start and stop discharging of the power supply.

Note: Von Operation will have a short delay (< 1 s) from when a condition exceeds or goes below a specified level to when the load's input state changes.

When Von Latch is ON, the electronic load will begin sinking current if input voltage exceeds Von voltage. When the input voltage drops below the Von voltage value, the electronic load will stop sinking current and the input will turn off.

Figure 15 - The Load's Operating Range with Von Latch set to ON

When Von Latch is OFF, the electronic load will begin sinking current if the input voltage exceeds the Von voltage. When the input voltage drops below the Von voltage value, the electronic load will still continue sinking current and the input remains on.

Figure 16 - Von Latch OFF The Load's Operating Range with Von Latch set to OFF

To set the Von modes, from the "CONFIG" menu, select "Von" and press **Enter** . The following will be displayed:

Use the and (arrows)) keys to select between "On" or "Off" and press confirm

selection. Afterwards, you will be prompted to enter the voltage point of "Von". Use the numeric keypad or rotary knob to change this value.

8.5.12 Configure Protection Settings

The electronic load has the following protection functions: Overvoltage protection (OVP), overcurrent protection (OCP), overpower protection (OPP), overtemperature protection (OTP), and local and remote reverse voltage protection (LRV/RRV).

The instrument will act appropriately once any of the above protections are active. You can press any button on the front panel to restore the protection function. For example, if the electronic load triggers the overtemperature protection, the buzzer will alarm, the input will automatically turn off, and the mainframe VFD will display OTP.

Some OCP and OPP features are configured from within the "Protect" menu. To access this menu, go into "CONFIG" menu and select "Protect". The following display will show:

8.5.13 PROTECT MENU

8.5.14 Max-P A-Limit P-Limit Time

8.5.15 Overcurrent Protection (OCP)

The electronic load includes both hardware and software overcurrent protection features.

“Hardware OCP” - The electronic load’s maximum input current will be limited to approximately 110% of the current range. Once the hardware OCP is triggered, the status register’s OC bit will be set. When the hardware OCP is removed, the status register’s OC bit will be reset. Hardware overcurrent protection will not affect the electronic load’s input on/off state.

“Software OCP” - Users can set the electronic load’s software OCP value with the following steps.

1. Go to “CONFIG” menu and select “Protect”. Then press **Enter**.
2. Select “A-limit” and press **Enter**.
3. To enable software OCP, select “On” and press **Enter**. The default is “Off”.
4. If enabled (ON), the load will prompt to enter a value for “Point”. Use the numeric keypad or rotary knob to enter the OCP current limit value, then press **Enter**. The valid range depends on the model of the load.
5. It will then prompt to enter a value for “Delay”. This is the protection trip delay, which is the amount of time to delay from when the input has reached the limit before triggering

OCP. Use the numeric keypad or rotary knob to enter a value, then press **Enter** to confirm change. The valid range is 0 – 60 seconds.

NOTE:

Software OCP will disable the input if the input current has reached or exceeded the protection limits.

Operations to Clear the OCP State

Check whether the input current is within the electronic load’s rated current or the programmed protection current ranges. If it is outside the range, disconnect the device under test. Then press any key on the front panel or remotely send SCPI command PROTECTION:CLEAR. The OCP displayed on the front panel will turn off and the load exits OCP protection state.



To start an OCP test, press “[]+ []”



Press “[]+ [CC]” (OCP) to enter OCP operation.
EDIT OCP TEST











1. VON LEVEL=0.000V: - Set Voltage threshold
2. VON DELAY=0.00S - After delay certain time, the DC load starts to draw current.
3. RANGE=3.000A - Set current range
4. START=0.1000A - Set start current
5. STEP=0.1000A - Set step current
6. STEP DEL=0.20S - Set delay time of each step
7. END=2.0000A - Set end current
8. OCP VOLT=2.000V - Set OVP value
9. MAX TRIP =1.5000A - Upper limit of OCP value
10. MIN TRIP=0.9000A - Lower limit of OCP value
11. SAVE OCP FILE=1 - Save OCP test file (1-10)

Set the power on mode to be OCP test mode:

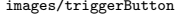
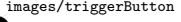
Operation - Display on front panel

1. Press “[]+ [8]” (system) enter into sysmtem menu - 0.0000V 0.000A POWER-ON BUZZER
2. Press right key,select RUNMODE and confirm - 0.0000V 0.000A RUN <NORMAL>
with  button -
3. Press direction key to select OCP_TEST,Press “” to confirm. - 0.0000V 0.000A RUN <OCP_TEST>
- 4,Press [Esc] button to quit the set. - 0.0000V 0.000A STOP 0.000A

After above steps,press []  button to run ocp test file. Recall OCP File:



1. Press “[]+ ”  button to select programe file,the panel displays “CALL OCP FILE= 1”. Enter the file name(1-10),press “” button to confirm.



2. According to the following steps to escape OCP mode:press “[]+ [8]” (system)——“RUNMODE” —— “[]” ——select “NORMAL” mode——“”.

8.5.16 Overpower Protection (OPP)

The electronic load includes both hardware and software OPP features.





“Hardware OPP” – In the event that the electronic load’s input power exceeds the set power protection limit, the hardware OPP will limit the power. Once the hardware OPP is triggered, the status register’s OP bit will be set. When the hardware OPP is removed, the status register’s OP bit will be reset. Hardware overpower protection will not turn the electronic load’s input off.

Follow the steps below to set the hardware OPP limit.

1. Go to “CONFIG” menu and select “Protect”. Then press  .
2. Select “Max-P” and press  .
3. The load will prompt to enter a value for “Point”. This is the hardware OPP limit value.

Use the numeric keypad or rotary knob to enter a value. Press  to confirm the change.



“Software OPP” - Users can set the electronic load’s software OPP value with the following steps.

1. Go to “CONFIG” menu and select “Protect”. Then press  .
2. Select “P-limit” and press  .
3. To enable software OPP, select “On” and press  . The default is “Off”.
4. If enabled (ON), the load will prompt to enter a value for “Point”. Use the numeric keypad or rotary knob to enter the OPP power limit value, then press  . The valid range depends on the model of the load.
5. It will then prompt to enter a value for “Delay”. This is the protection trip delay, which is the amount of time to delay from when the input has reached the limit before triggering

OPP. Use the numeric keypad or rotary knob to enter a value, then press  to confirm change. The valid range is 0 – 60 seconds.

Operations to Clear the OPP State

Check whether the input power is within the rated power range or the programmed protection ranges. If it is outside the range, disconnect the device under test. Then press any key on the front panel or remotely send command PROTECTION:CLEAR. The OPP displayed on the front panel will turn off and the electronic load exits OPP protection state.

To start a OPP test, press “[]+ []” (Trigger).

Press “[]+ [CW]” (OPP) to enter OPP test operation.

OPP TEST RUN

OPP TEST

STOP Run OPP test file

CALL OPP TEST



Recall OPP File=1 Recall OPP test file(range file1-file10)

EDIT OPP TEST

1. VON LEVEL=0.000V - - Set Voltage on value
2. VON DELAY=0.01S - - Set Voltage on delay time
3. RANGE=5A - - Set working current range
4. START =0.1W - - Set start power value
5. STEP =1W - - Set step power value
6. STEP DEL=1S - - Set step delay time
7. END =12W - - Set cut-off power value
8. OPP VOLT=7V - - Set OPP value
9. MAX TRIP =6.5W - - Upper limit of OPP value
10. MIN TRIP =5.6W - - Lower limit of OPP value
11. SAVE OPP FILE=1 - - Save OPP test file

Set the power on mode to be OPP test mode

Operation - Display on front pannel

1. Press “[]+ [8]” (system) enter into sysmtem menu - 0.0000V 0.000A POWER-ON BUZZER
2. Press right key,select RUNMODE and - 0.0000V 0.000A RUN <NORMAL> confirm with “” button -
3. Press direction key to OCP_TEST,Press “” to confirm. - select - 0.0000V 0.000A RUN <OPP_TEST>
4. Press “[Esc]” button to quit the set. - - 0.0000V 0.000A STOP 0.000A

After above steps,press [] button to run OPP test file.





 name: images/triggerButton

file:

8.5.17 Recall OPP File

 name: images/triggerButton

state:

1. Press “[]+ ” button to select programe file,the panel displays “CALL OPP FILE= 1”. Enter the file name(1-10), press  button to confirm.
2. According to the following steps to escape OPP mode:press []+ [8]

(system)——RUNMODE——**Enter**——select “NORMAL” mode——**Enter**.

8.5.18 Overvoltage Protection (OVP)

The instrument's maximum OVP limit is 110% of the maximum rated voltage.

If the OVP circuit has triggered, input will turn off, buzzer alarm will go off, and the status register's OV and VF bit will be set. The mainframe will display OVP and the condition will remain until they are reset. Once over-voltage protection occurs, the “VF” pin on the rear panel will output TTL Low voltage level. Under normal conditions, it outputs a 5 V TTL high signal.

Operations to Clear the OVP State

Check whether the input voltage is within the electronic load's rated voltage or the programmed protection voltage ranges. If it is outside the range, please disconnect the device under test. Then press any key on the front panel or remotely send SCPI command

PROtection:CLEar. The OVP displayed on the front panel will turn off and the electronic load exits OVP protection state.

8.5.19 Over-temperature Protection (OTP)

There is an overtemperature protection circuit, which will turn off the input if the internal temperature exceeds safe limits. When the electronic load's internal circuit temperature is over 85C, the load will enable OTP. Input will automatically be turned off and the VFD will display OTP. At the same time the OT and PS bits in the status register will be set and remain until they are reset.

Operations to Clear the OTP State

When the electronic load temperature has dropped below the protection point, press any key on the front panel or remotely send command PROtection:CLEar. The OTP displayed on the front panel will turn off and the electronic load exits OTP protection state.

8.5.20 Reverse Voltage Protection (LRV/RRV)

This function protects the electronic load in case the input DC voltage lines are connected with the wrong polarity. When a reverse voltage (LRV – local reverse voltage, RRV – remote reverse voltage) connection condition is detected, the input will immediately turn off, the buzzer will alarm the user, and the status register's reverse voltage (LRV/RRV) and VF bits will be set. The load will display LRV/RRV until they are reset.

In this condition, the “VF” pin will output a low level.

Operations to Clear the Reverse Voltage State

Check whether the connection is reversed. If so, disconnect the device to be measured and the reverse voltage state will be cleared.

8.5.21 Configure Timed Input

The load has a built-in timer function that is configured to allow enabling (ON) the main input for a specified amount of time. To configure this time, follow the steps below:

1. Go to “CONFIG” menu and select “Protect”. Then press **Enter** .
2. Select “Time” and press **Enter** .
3. To enable timed input, select “On” and press **Enter** . The default is “Off”.

4. It will then prompt to enter a value for “Delay”. This is the amount of time to enable the input from when the is pressed (or when input is turned ON remotely). Once this time is past, input will be disabled (OFF). Use the numeric keypad or rotary knob to enter the value. Press **Enter** to confirm the change. The valid range is 0 – 60000 seconds.
5. Now, press **ESC** twice to exit the menu. The instrument will show the delay timer as follows:

8.5.22 Measurement Configurations

Voltage Auto Range

By default, the load has auto range enabled for voltage measurements and operations. To enable or disable, follow the steps below:

1. Go to “CONFIG” menu and select “Measure” and press **Enter**.
2. Select “V-Range” and press **Enter**.
3. To enable voltage auto range, select “On” and press **Enter**. To disable, select “Off” and press **Enter** to confirm the change.

Measuring Rise and Fall Time

The instrument can measure the rise or fall time from a specified start and stop voltage level of the measured input. This feature requires the display timer to be enabled first. To enable timer, please follow the instructions in the “Display Input On Timer” section of “SYSTEM Menu”.

To setup this measurement, follow the steps below:

1. Go to “CONFIG” menu and select “Measure”. Then press **Enter**.
2. Select “TimeV1” and press **Enter**. The load will prompt to enter a value. Use the numeric keypad or rotary knob to set a value and press **Enter** to confirm. This is for the start voltage level. When the measured input voltage reaches this level, the timer will start.
3. Now, select “TimeV2” from the “Measure” menu and press **Enter**. The load will prompt to enter a value. Use the numeric keypad or rotary knob to set a value and press **Enter** to confirm. This is for the stop voltage level. When the measured input voltage reaches this level, the timer will stop. The time on display will show the time difference between the measured start and stop voltage level.

Measurement Averaging Filter

The measurement averaging filter is adjusted. Increasing the averaging will provide more accurate readings, but slower measurement update rate. Decreasing the averaging will provide faster measurement update rate, but less accurate readings.

To configure, follow the steps below:

1. Go to “CONFIG” menu and select “Measure”. Then press **Enter**.
2. Select “Filter” and press **Enter**. The load will prompt to enter a value for “Average Count”.
3. Use the numeric keypad or rotary knob to adjust this value, then press **Enter** to save the change. The valid range is from 2 – 16 ($2^2 - 2^{16}$). The default is 14 (2^{14}).

Protection Functions

1 OCP Test Function

The load has a built-in OCP test function that can be used to automate testing for OCP conditions. The load can save up to 5 OCP test programs into internal memory, which can be recalled and run.

The OCP Test program requires the following parameters be configured before it can be run.

“Voltage On Level”	This is the minimum voltage level the load measures before the start of the test.
“Voltage On Delay”	This is the delay time from when the Voltage On Level is reached to the actual start of the test.
“Current Range”	This specifies the current range of the test. All models have two current ranges, with the lower range allowing for higher resolution. This value will also limit the maximum current settings for other parameters configured for the test program.
“Start Current”	This is the starting current value when OCP test begins. The settable range of this value is limited by “Current Range”.
“Step Current”	This is the size of the step current as the test runs from the “Start Current” to “End Current”. The test will only run through in steps if the measured input voltage is greater than the “OCP Voltage”. Otherwise, the test will end after running the “Start Current” for the amount of time specified in “Step Delay”.
“Step Delay”	This is the delay time to hold each current step in the test. This determines how fast or slow to run through the test.
“End Current”	This is the ending current value before OCP test ends. The test will only run through in steps from “Start Current” to the “End Current” if input voltage is greater than the “OCP Voltage”. The settable range of this value is limited by “Current Range”.
“OCP Voltage”	This value is a limit that is used to test for OCP conditions. In the event of an over current condition, when the input voltage is greater than this value, the test will run through from “Start Current” to “End Current” in steps. The input current (the over current) value will be checked during this process. If current is within the “Max Trip Current” and “Min Trip Current” boundaries, the load will indicate “Pass” at the end of the test. If outside of these boundaries, the load will indicate “Fault”.
“Max Trip Current”	The maximum acceptable current limit of the over current value.
“Min Trip Current”	The minimum acceptable current limit of the over current value.

The following is a step by step procedure to configure an OCP test program.

1. Press) and to enter the “OCP Test” menu. The following will be displayed:

1. Select “Edit” and press (enter) . Enter a value using the numeric keypad or rotary knob for “Voltage On Level”. The value must be within the maximum input limits of the load.

Press (enter) to continue.

1. Enter a value for “ Voltage On Delay”. This can be set between 0.00s and 99.99s. Then press (enter) to continue.
2. Follow the same steps for “ Current Range”. The value must be within the maximum input limits of the load. Press (enter) to continue.
3. Set the “Start Current”. The value must be less than “Current Range”. Press (enter) to continue.
4. Do the same for “Step Current” and “End Current”. Press (enter) after each setting to continue.
5. Enter a value for “OCP Voltage” and press (enter) to continue.

6. Finally, enter a value for “Max Trip Current”, and then “Min Trip Current”. Press (enter) after each settings to continue.

7. The load will prompt to “Save OCP File”. Select a number between 1 and 5. Then press

(enter) to save all settings to the selected location.

Note: At any time when configuring any parameters for the test, you can press the key to select the previous parameter to edit.

To recall the settings:

1. Press) and to enter the “OCP Test” menu. Select “Recall” and press
2. Use the keypad or knob to select the saved location number and press . All settings will be recalled when selecting “Edit” from the “OCP Test” menu.

To run the OCP test:

1. Recall the settings from memory by following the steps above.
2. Then, from the “OCP Test” menu, select “Run” and press . The display will show the following:

Press (.)trig to start the test. When the test is running, “Run” will be indicated in place of “Stop”. When the test ends, either “Pass” or “Fault” will appear next to “Stop”.

4. To stop the test at any time, press .

2 OPP Test Function

The load has a built-in OPP test function that can be used to automate testing for OPP conditions. The load can save up to 5 OPP test programs into internal memory, which can be recalled and run.

The OPP Test program requires the following parameters be configured before it can be run.

“Voltage On Level”	This is the minimum voltage level the load measures before the start of the test.
“Voltage On Delay”	This is the delay time from when the “Voltage On Level” is reached to the actual start of the test.
“Current Range”	This specifies the current range of the test. All models have two current ranges, with the lower range allowing for higher resolution. This value will also limit the maximum settings for other parameters configured for the test program.
“Start Power”	This is the starting power value when OPP test begins.
“Step Power”	This is the size of the step power as the test runs from the “Start Power” to “End Power”. The test will only run through in steps if the measured input voltage is greater than the “OPP Voltage”. Otherwise, the test will end after running the “Start Power” for the amount of time specified in Step

“Delay”.

The following is a step by step procedure to configure an OPP test program.

1. Press) and to enter the “OPP Test” menu. The following will be displayed:

3 OPP TEST

DC load protection features include: OVP, OCP, OPP, OTP, reverse voltage protection (LRV/RRV).

4 Over Voltage Protection (OVP)

If input voltage exceeds the voltage limit set by the user, the DC load will turn the input OFF and the buzzer will sound. The display will show OVP.

“Step Delay”	This is the delay time to hold each power step in the test. This determines how fast or slow to run through the test.
“End Power”	This is the ending power value before OPP test ends. The test will only run through in steps from “Start Power” to the “End Power” if input voltage is greater than the “OPP Voltage”.
“OPP Voltage”	This value is a limit that is used to test for OPP conditions. In the event of an over power condition, when the input voltage is greater than this value, the test will run through from “Start Power” to “End Power” in steps. The input power (the over power) value will be checked during this process. If power is within the “Max Trip Power” and “Min Trip Power” boundaries, the load will indicate “Pass” at the end of the test. If outside of these boundaries, the load will indicate “Fault”.
“Max Trip Power”	The maximum acceptable power limit of the over power value.
“Min Trip Power”	The minimum acceptable power limit of the over power value.

Operations to clear the OVP state

Disconnect the instrument under test. Press any key on the front panel, the OVP on the VFD will disappear, then the DC load exits OVP protection state.

5 Over Current Protection (OCP)

The DC load includes both hardware and software over current protection features.

Hardware OCP: maximum input current of the DC load will be limited at about 110% of the current range, once the hardware OCP is activated, the status register’s OC bit will be set; when the hardware OCP is removed, the status register’s OC bit will be reset. Hardware over current protection won’t change the DC load’s On/Off state.

Software OCP: users can set the DC load’s software OCP value, steps:

[Shift] + [9] > Protect > Alimit set ON, Apoint set OCP current value, Adelay set delay time before alarm. When the software OCP function is active, the DC load will automatically turn off, VFD displays OCP.

Operations to clear the OCP state

Disconnect the instrument under test. Press any key on the front panel, the OCP displayed on the VFD will disappear, the DC load exits OCP protection state.

6 Over Power Protection (OPP)

The DC load includes both hardware and software OPP features.

Hardware OPP: the DC load allows user to set a power protection limit in hardware which will limit the power in the range you set when the OPP occur. The hardware OPP protection will not change the ON/OFF state of the the DC load.

Software OPP: users can set the DC load’s software OPP value, steps: [Shift] + [9] > Protect > P-LIMIT > P-LIM POINT set OPP power value, P-LIM DELAY set alarm delay. If the the DC load’s power value reach OPP limit and after the delay time, the DC load will automatically turned off, VFD will display OPP.

Operations to Clear the OPP State

Disconnect the instrument under test. Press any key on the front panel, the OPP displayed on the VFD will disappear, the DC load exits OPP protection state.

7 Over Temperature Protection (OTP)

If internal temperature exceeds safety limits(85C ;185F), the Over temperature circuitry will be activated. The DC Load will turn off the input, the buzzer will sound, and the display will show OTP.

Operations to Clear the OTP State

When the DC load temperature drops to the protecting point, press any key on the front panel, the OTP) displayed on the front panel will disappear, the DC load exits OTP protection state.

8 Reverse Voltage Protection (LRV)

This feature protects the DC load in case the DC input terminals are connected to a power source with reversed polarity. If a reverse voltage condition is detected, the buzzer will sound and will be displayed on the VFD.

Operations to Clear the Reverse Voltage State

Check whether the connection is reversed; if so disconnect the power source.

Remote Operation

10.1 Interface Connection

10.2 Serial Interface

PIN	Description
1	-
2	Transmit Data
3	Receive Data
4	-
5	GND
6	-
7	CTS
8	RTS
9	-

A straight pin-to-pin DB9 female to DB9 male serial cable is required for using the RS-232 interface. Do not use a null modem or crossover DB9 serial cable.

10.2.1 GPIB

The load can be configured with a GPIB address from 0 – 31. To communicate via GPIB, connect a GPIB cable to the GPIB interface on the rear panel, as illustrated below.

10.2.2 USBTMC

The device is SR1, RL1, and DT1 enabled. It can receive the following request: REN_CONTROL, GO_TO_LOCAL, LOCAL_LOCKOUT. When it receives MsgID = TRIGGER USBTMC command, it will transmit TRIGGER command to the function layer.

10.2.3 Remote Commands

The instrument supports some SCPI commands and some instrument specific commands. These commands enable a computer to remotely communicate and control the instrument over any of the supported remote interfaces: USBTMC, RS-232, and GPIB.

Refer to the programming manual for details, which can be downloaded from www.bkprecision.com.

Troubleshooting Guide

Below are some frequently asked questions and answers. Please check if any apply to your instrument before contacting B&K Precision.

1 General

Q: I cannot power up the instrument.

Check that the power cord is securely connected to the AC input and there is live power from your electrical AC outlet. Verify that the AC power coming from the mains have the correct voltage. The load can accept a specific range of AC input voltages. Refer to section “.

Q: I cannot set power (in CW) or current (in CC) at the maximum rating.

4. Check the power and current “Limits” from the “Protect” menu within the “CONFIG” menu. Refer to section 3.4 for details.

2 Remote Control

Q: I am trying to send the commands over USB/RS232, but it does not seem to respond.

Check that you are sending ASCII strings that are terminated with a CR (carriage return) and LF (line feed) character. For RS-232, check that the baud rate, parity, data bits, stop bit, and flow control settings match with the settings configured on the software interface. To check these settings, go to the “SYSTEM” menu and enter the “Communication” menu, and select RS-232.

3 Error Information References

The following error information may occur when an error occurs during Power On self-test:

- If the EEPROM was damaged, the VFD will display “Eeprom Fail”.
- If the latest operation data in EEPROM is lost, then VFD will display “Config Data Lost”.
- If the calibration data in EEPROM is lost, then VFD will display “Cal data lost”.
- If the system setting data in EEPROM is lost, the VFD will display “Eeprom data lost”. Please press [**Shift**] + [**4**] and [**0**] to save after setting parameters.

4 Exception handling

If the electronic load cannot start normally, please check and take measures by reference to steps below.

1. Check whether the power line is correctly connected and confirm whether the electronic load is powered. Correct wiring of power line => 2

Incorrect wiring of power line => Re-connect the power line and check whether the exception is removed.

1. Check whether the power in On. [**Power**] key is under

Yes => 3

No => Please check the [**Power**] key to start power and check whether the exception is removed.

1. Check whether set power voltage of electronic load is larger than the power supply voltage. If set power voltage is 220 V and the supply voltage is 110V, the electronic load cannot start.

2. Check whether the fuse of electronic fuse is burned out.

If yes, change fuse. Detailed steps:

- Pull out power line and take out the fuse box at power line jack with a small screw driver. As shown below.
- If the fuse is fused, please change fuse of same specification based on machine model. See the table below for matching information of fuse and machine model.

Specifications

Note: All specifications apply to the unit after:

1. A temperature stabilization time of 15 minutes over an ambient temperature range of $23\text{ }^{\circ}\text{C} \pm 5\text{ }^{\circ}\text{C}$.
2. Short correction operation performed before making measurement.

Specifications are subject to change without notice.

Specifications

Note: All specifications apply to the unit after a temperature stabilization time of 30 minutes over an ambient temperature range of 23 °C ± 5 °C.

Model		8542B	8500B	8502B	8510B	8514B
Input ratings						
Input voltage		0 to 150 V	0 to 150 V	0 to 500 V	0 to 120 V	0 to 120 V
Input current	Low	0 to 3 A	0 to 3 A	0 to 3 A	0 to 12 A	0 to 24 A
	High	0 to 30 A	0 to 30 A	0 to 15 A	0 to 120 A	0 to 240 A
Input power		150 W	300 W	300 W	600 W	1500 W
Minimum operating voltage	Low	0.25 V at 3 A	0.14 V at 3 A	0.6 V at 3 A	0.2 V at 12 A	0.25 V at 24 A
	High	2.5 V at 30 A	1.4 V at 30 A	3 V at 15 A	2 V at 120 A	2.5 V at 240 A
CV mode						
Range	Low	0.1 to 18 V		0.1 to 50 V	0.1 to 18 V	
	High	0.1 to 150 V		0.1 to 500 V	0.1 to 120 V	
Resolution	Low	1 mV				
	High	10 mV				
Accuracy	Low	±(0.05% + 0.02% FS)				
	High	±(0.05% + 0.025% FS)				
CC mode						
Range	Low	0 to 3 A		0 to 3 A	0 to 12 A	0 to 24 A
	High	0 to 30 A		0 to 15 A	0 to 120 A	0 to 240 A
Resolution	Low	0.1 mA			1 mA	1 mA
	High	1 mA			10 mA	10 mA
Accuracy	Low	±(0.05% + 0.05% FS)				
	High	±(0.05% + 0.05% FS)				
CR mode						
Range	Low	0.05 Ω to 10 Ω		0.3 Ω to 10 Ω	0.05 Ω to 10 Ω	0.05 Ω to 10 Ω
	High	10 Ω to 7.5 kΩ		10 Ω to 7.5 kΩ	10 Ω to 7.5 kΩ	10 Ω to 7.5 kΩ
Resolution		16 bit				
Accuracy	Low	0.01% + 0.08 S (0.01% + 12.5 Ω)				
	High	0.01% + 0.0008 S (0.01% + 1250 Ω)				
CW mode						
Range		150 W	300 W	300 W	600 W	1500 W
Resolution		10 mW	10 mW	10 mW	10 mW	10 MW
Accuracy		±(0.2% + 0.2% FS)	±(0.1% + 0.1% FS)		±(0.2% + 0.2% FS)	
Transient mode (CC mode)						
T ₁ & T ₂ ⁽¹⁾		50 μs to 3600 s/Resolution: 1 μs			100 μs to 3600 s/Resolution: 1 μs	
Accuracy		5 μs ± 100 ppm				10 μs ± 100 ppm
Slew rate ⁽²⁾	Low	0.0001 to 0.2 A/μs		0.0001 to 0.2 A/μs	0.001 to 0.2 A/μs	0.001 to 0.3 A/μs
	High	0.001 to 1 A/μs	0.001 to 0.8 A/μs	0.001 to 0.4 A/μs	0.01 to 0.8 A/μs	

(1) Fast pulse trains with large transitions may not be achievable.

(2) The slew rate specifications are not warranted but are descriptions of typical performance. The actual transition time is defined as the time for the input to change from 10% to 90%, or vice versa, of the programmed current values. In case of very large load changes, e.g. from no load to full load, the actual transition time will be larger than the expected time. The load will automatically adjust the slew rate to fit within the range (high or low) that is closest to the programmed value.

Specifications (continued)

Model		8542B	8500B	8502B	8510B	8514B
Readback voltage						
Range	Low	0 to 18 V		0 to 50 V	0 to 18 V	
	High	0 to 150 V		0 to 500 V	0 to 120 V	
Resolution	Low	0.1 mV		1 mV	0.1 mV	
	High	1 mV		10 mV	1 mV	
Accuracy		±(0.05% + 0.05% FS)				
Readback current						
Range	Low	0 to 3 A		0 to 3 A	0 to 12 A	0 to 24 A
	High	0 to 30 A		0 to 15 A	0 to 120 A	0 to 240 A
Resolution	Low	0.1 mA			1 mA	
	High	1 mA			10 mA	
Accuracy		±(0.05% + 0.05% FS)				
Readback power						
Range		150 W	300 W	300 W	600 W	1500 W
Resolution		10 mW				
Accuracy		±(0.1% + 0.1% FS)			±(0.2% + 0.2% FS)	
Protection range (typical)						
OPP		160 W	320 W	320 W	620 W	1550 W
OCP	Low	3.3 A		3.3 A	13 A	26.7 A
	High	33 A		16 A	130 A	267 A
OVP		160 V		530 V	125 V	125 V
OTP		185 °F (85 °C)			203 °F (95 °C)	185 °F (85 °C)
Short circuit (typical)						
Current (CC)	Low	3.3 A	3.3 A	3.3 A	13 A	26.7 A
	High	33 A	33 A	16 A	130 A	267 A
Voltage (CV)		0 V				
Resistance (CR)		80 mΩ	40 mΩ	180 mΩ	15 mΩ	8 mΩ
General						
Input terminal impedance (typical)		150 kΩ		1 MΩ	150 kΩ	
AC input		110 V/220 V ±10%, 50/60 Hz				
I/O Interface		DB9 (TTL) with TTL to USB serial adapter				USB, RS232
Temperature	Operating	32 °F to 104 °F (0 °C to 40 °C)				
	Storage	14 °F to 140 °F (-10 °C to 60 °C)				
Humidity		Indoor use, ≤ 95 %				
Safety		EN 61010-1:2010, Low Voltage Directive (LVD) 2014/35/EU				
Electromagnetic compatibility		EN61326-1:2013, CISPR II, EN 61000-3-2:2014, EN61000-3-3:2013, EMC Directive 2014/30/EU				
Dimensions (W x H x D)		8.5" x 3.5" x 14" (214.5 x 88.2 x 354.6 mm)			8.5" x 3.5" x 18.5" (214.5 x 88.2 x 470 mm)	17.2" x 3.5" x 18.5" (436.5 x 88.2 x 470 mm)
Weight		10.3 lbs (4.7 kg)			15.8 lbs (7.2 kg)	45 lbs (20.5 kg)
Warranty		3 years				
Standard accessories		Power cord, USB cable, certificate of calibration, USB to TTL serial converter IT-EI32B ⁽³⁾ , rack-mount ears ⁽⁴⁾				
Optional accessories		TLPWRI high current test leads, IT-EISI rackmount kit				

(3) Standard for 8542B, 8500B, 8502B, and 8510B models only. (4) Standard for 8514B only.

Service Information

Warranty Service: Please go to the support and service section on our website at bkprecision.com to obtain an RMA #. Return the product in the original packaging with proof of purchase to the address below. Clearly state on the RMA the performance problem and return any leads, probes, connectors and accessories that you are using with the device.

Non-Warranty Service: Please go to the support and service section on our website at bkprecision.com to obtain an RMA #. Return the product in the original packaging to the address below. Clearly state on the RMA the performance problem and return any leads, probes, connectors and accessories that you are using with the device. Customers not on an open account must include payment in the form of a money order or credit card. For the most current repair charges please refer to the service and support section on our website.

Return all merchandise to B&K Precision Corp. with prepaid shipping. The flat-rate repair charge for Non-Warranty Service does not include return shipping. Return shipping to locations in North America is included for Warranty Service. For overnight shipments and non-North American shipping fees please contact B&K Precision Corp.

B&K Precision Corp.

: 22820 Savi Ranch Parkway

Yorba Linda, CA 92887

bkprecision.com

714-921-9095

Include with the returned instrument your complete return shipping address, contact name, phone number and description of problem.

LIMITED THREE-YEAR WARRANTY

B&K Precision Corp. warrants to the original purchaser that its products and the component parts thereof, will be free from defects in workmanship and materials for a period of **three years** from date of purchase.

B&K Precision Corp. will, without charge, repair or replace, at its option, defective product or component parts. Returned product must be accompanied by proof of the purchase date in the form of a sales receipt.

To help us better serve you, please complete the warranty registration for your new instrument via our website www.bk-precision.com

Exclusions: This warranty does not apply in the event of misuse or abuse of the product or as a result of unauthorized alterations or repairs. The warranty is void if the serial number is altered, defaced or removed.

B&K Precision Corp. shall not be liable for any consequential damages, including without limitation damages resulting from loss of use. Some states do not allow limitations of incidental or consequential damages. So the above limitation or exclusion may not apply to you.

This warranty gives you specific rights and you may have other rights, which vary from state-to-state.

B&K Precision Corp.
22820 Savi Ranch Parkway
Yorba Linda, CA 92887
www.bkprecision.com
714-921-9095

Version: November 12, 2019