

### Low Noise Silicon Bipolar RF Transistor

- Low noise amplifier designed for low voltage applications, ideal for 1.2 V or 1.8 V supply voltage. Supports  $V_{CC} = 2.9$  V with enough external collector resistance.
- High gain and low noise at high frequencies due to high transit frequency  $f_T = 45$  GHz
- Common e.g. in cordless phones and satellite receivers
- Easy to use Pb-free (RoHS compliant) and halogen free industry standard package with visible leads
- Qualification report according to AEC-Q101 available

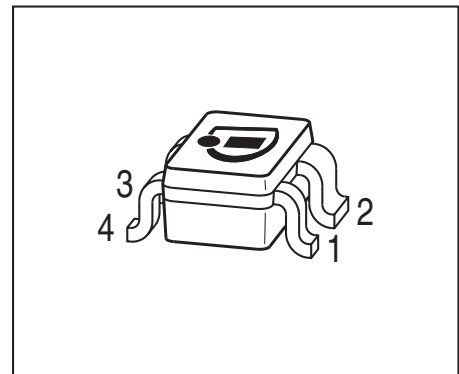

**ESD (Electrostatic discharge) sensitive device, observe handling precaution!**

Type	Marking	Pin Configuration						Package
BFP520	APs	1=B	2=E	3=C	4=E	-	-	SOT343

**Maximum Ratings** at  $T_A = 25$  °C, unless otherwise specified

Parameter	Symbol	Value	Unit
Collector-emitter voltage $T_A = 25$ °C $T_A = -55$ °C	$V_{CEO}$	2.5 2.4	V
Collector-emitter voltage	$V_{CES}$	10	
Collector-base voltage	$V_{CBO}$	10	
Emitter-base voltage	$V_{EBO}$	1	
Collector current	$I_C$	50	mA
Base current	$I_B$	5	
Total power dissipation <sup>1)</sup> $T_S \leq 105$ °C	$P_{tot}$	125	mW
Junction temperature	$T_J$	150	°C
Storage temperature	$T_{Stg}$	-55 ... 150	

<sup>1)</sup>  $T_S$  is measured on the emitter lead at the soldering point to pcb

**Thermal Resistance**

Parameter	Symbol	Value	Unit
Junction - soldering point <sup>1)</sup>	$R_{thJS}$	450	K/W

**Electrical Characteristics at  $T_A = 25^\circ\text{C}$ , unless otherwise specified**

Parameter	Symbol	Values			Unit
		min.	typ.	max.	

**DC Characteristics**

Collector-emitter breakdown voltage $I_C = 1 \text{ mA}, I_B = 0$	$V_{(BR)CEO}$	2.5	3	3.5	V
Collector-emitter cutoff current $V_{CE} = 2 \text{ V}, V_{BE} = 0$ $V_{CE} = 10 \text{ V}, V_{BE} = 0$	$I_{CES}$	-	1	30	nA
		-	-	1000	
Collector-base cutoff current $V_{CB} = 2 \text{ V}, I_E = 0$	$I_{CBO}$	-	-	30	
Emitter-base cutoff current $V_{EB} = 0.5 \text{ V}, I_C = 0$	$I_{EBO}$	-	100	3000	
DC current gain $I_C = 20 \text{ mA}, V_{CE} = 2 \text{ V}, \text{ pulse measured}$	$h_{FE}$	70	110	170	-

<sup>1)</sup>For the definition of  $R_{thJS}$  please refer to Application Note AN077 (Thermal Resistance Calculation)

**Electrical Characteristics at  $T_A = 25^\circ\text{C}$ , unless otherwise specified**

Parameter	Symbol	Values			Unit
		min.	typ.	max.	
<b>AC Characteristics (verified by random sampling)</b>					
Transition frequency $I_C = 30\text{ mA}$ , $V_{CE} = 2\text{ V}$ , $f = 2\text{ GHz}$	$f_T$	32	45	-	GHz
Collector-base capacitance $V_{CB} = 2\text{ V}$ , $f = 1\text{ MHz}$ , $V_{BE} = 0$ , emitter grounded	$C_{cb}$	-	0.07	0.13	pF
Collector emitter capacitance $V_{CE} = 2\text{ V}$ , $f = 1\text{ MHz}$ , $V_{BE} = 0$ , base grounded	$C_{ce}$	-	0.3	-	
Emitter-base capacitance $V_{EB} = 0.5\text{ V}$ , $f = 1\text{ MHz}$ , $V_{CB} = 0$ , collector grounded	$C_{eb}$	-	0.33	-	
Minimum noise figure $I_C = 2\text{ mA}$ , $V_{CE} = 2\text{ V}$ , $Z_S = Z_{Sopt}$ , $f = 1.8\text{ GHz}$	$NF_{min}$	-	0.95	-	dB
Power gain, maximum stable <sup>1)</sup> $I_C = 20\text{ mA}$ , $V_{CE} = 2\text{ V}$ , $Z_S = Z_{Sopt}$ , $Z_L = Z_{Lopt}$ , $f = 1.8\text{ GHz}$	$G_{ms}$	-	24	-	dB
Insertion power gain $V_{CE} = 2\text{ V}$ , $I_C = 20\text{ mA}$ , $f = 1.8\text{ GHz}$ , $Z_S = Z_L = 50\ \Omega$	$ S_{21} ^2$	-	21.5	-	
Third order intercept point at output $V_{CE} = 2\text{ V}$ , $I_C = 20\text{ mA}$ , $f = 1.8\text{ GHz}$ , $Z_S = Z_{Sopt}$ , $Z_L = Z_{Lopt}$ $V_{CE} = 2\text{ V}$ , $I_C = 7\text{ mA}$ , $f = 1.8\text{ GHz}$ , $Z_S = Z_{Sopt}$ , $Z_L = Z_{Lopt}$	$IP_3$	-	25	-	dBm
		-	17	-	
1dB compression point at output $I_C = 20\text{ mA}$ , $V_{CE} = 2\text{ V}$ , $Z_S = Z_{Sopt}$ , $Z_L = Z_{Lopt}$ , $f = 1.8\text{ GHz}$ $I_C = 7\text{ mA}$ , $V_{CE} = 2\text{ V}$ , $Z_S = Z_{Sopt}$ , $Z_L = Z_{Lopt}$ , $f = 1.8\text{ GHz}$	$P_{-1dB}$	-	12	-	
		-	5	-	

<sup>1</sup> $G_{ms} = |S_{21} / S_{12}|$

**Total power dissipation  $P_{tot} = f(T_S)$**

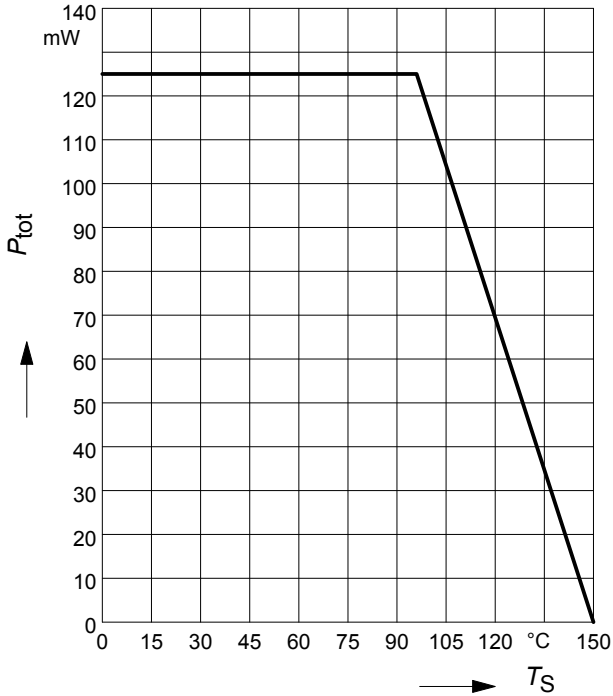

**Collector-base capacitance  $C_{cb} = f(V_{CB})$   
 $f = 1\text{ MHz}$**

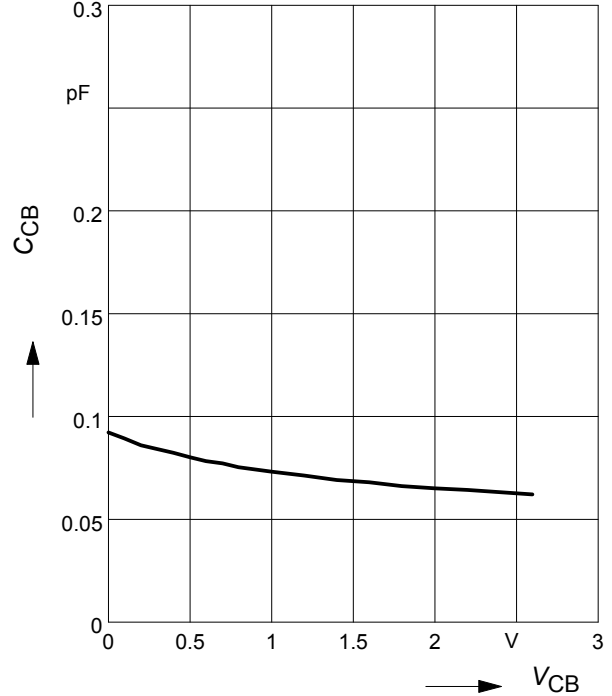

**Third order Intercept Point  $IP_3 = f(I_C)$**

(Output,  $Z_S = Z_L = 50 \Omega$ )

$V_{CE} = \text{parameter}, f = 900 \text{ MHz}$

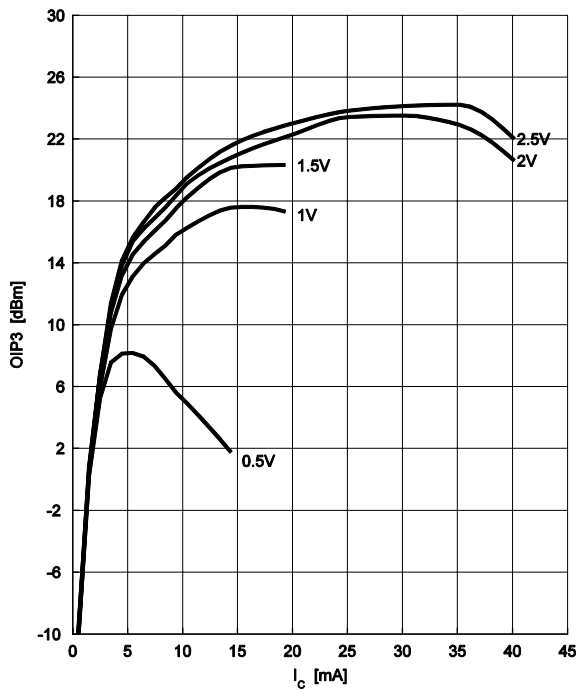

**Transition frequency  $f_T = f(I_C)$**

$f = 2 \text{ GHz}$

$V_{CE} = \text{parameter in V}$

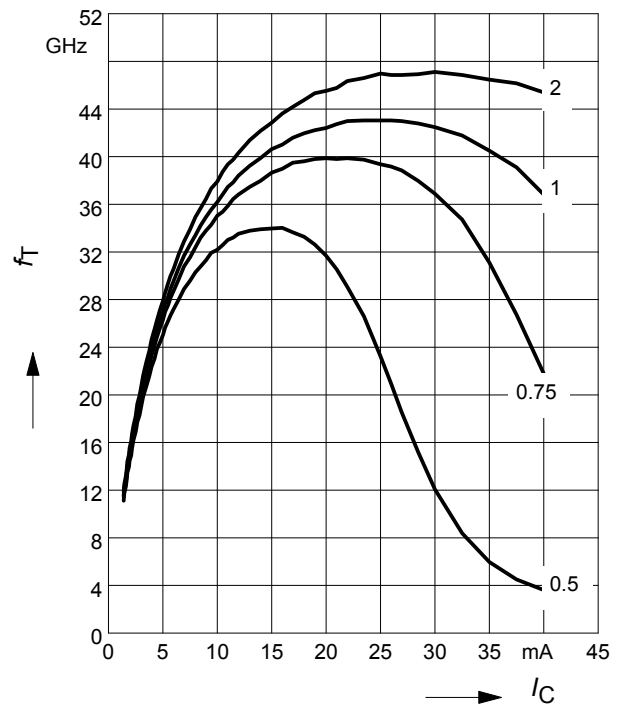

**Power gain  $G_{ma}$ ,  $G_{ms}$ ,  $|S_{21}|^2 = f(f)$**   
 $V_{CE} = 2\text{ V}$ ,  $I_C = 20\text{ mA}$

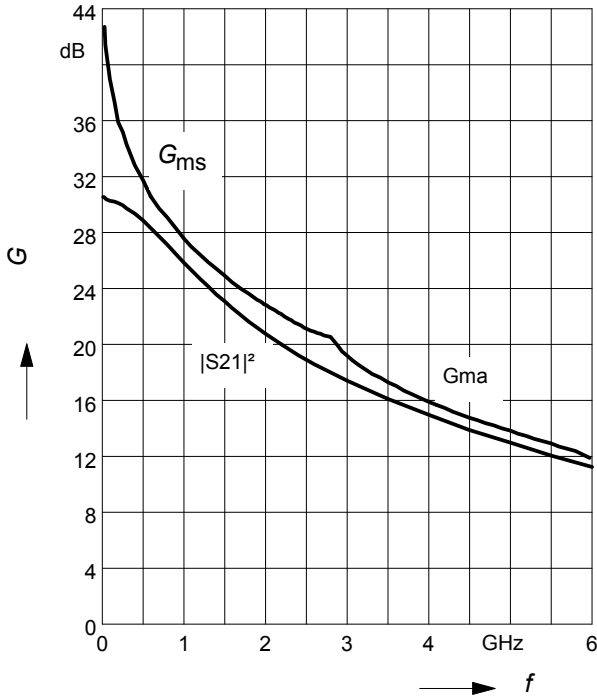

**Power gain  $G_{ma}$ ,  $G_{ms} = f(I_C)$**   
 $V_{CE} = 2\text{ V}$   
 $f = \text{parameter in GHz}$

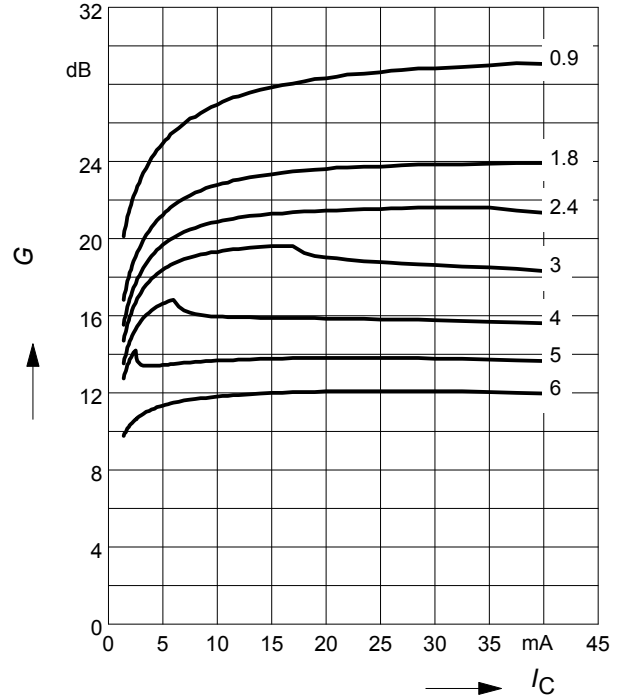

**Power gain  $G_{ma}$ ,  $G_{ms} = f(V_{CE})$**   
 $I_C = 20\text{ mA}$   
 $f = \text{parameter in GHz}$

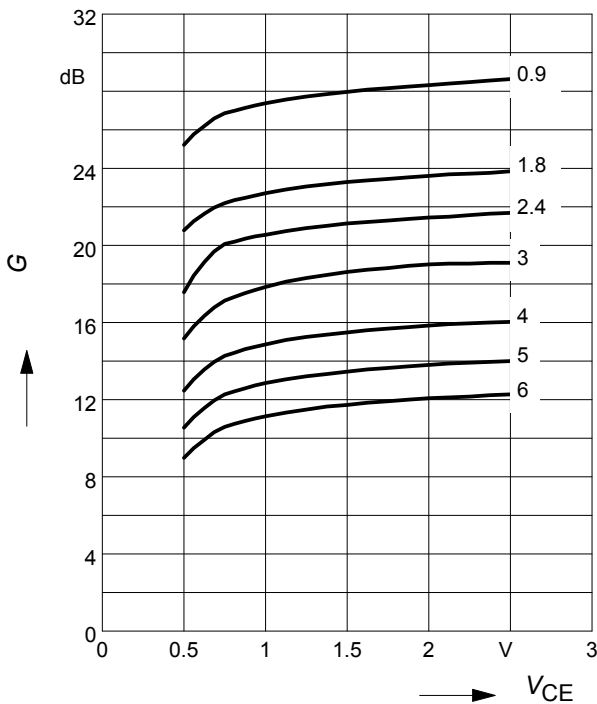

**Minimum noise figure  $NF_{min} = f(I_C)$**   
 $V_{CE} = 2\text{ V}$ ,  $Z_S = Z_{Sopt}$

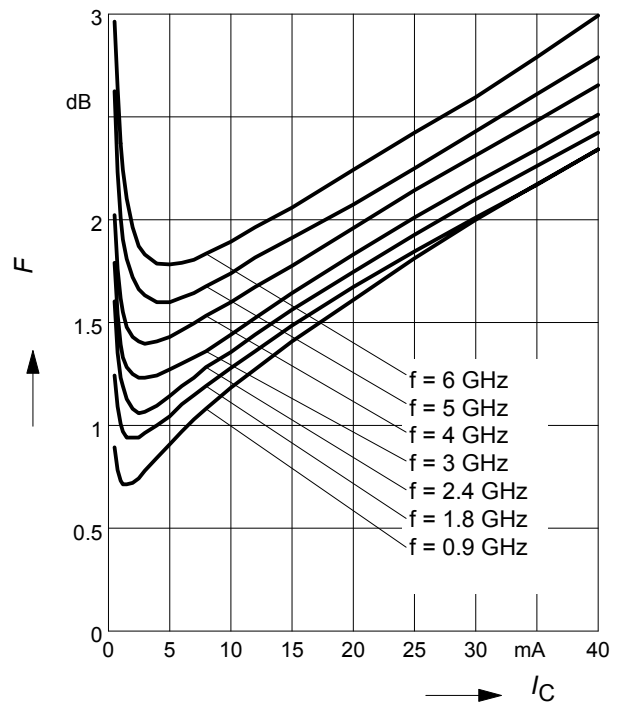

**Noise figure  $F = f(I_C)$**

$V_{CE} = 2\text{ V}, f = 1.8\text{ GHz}$

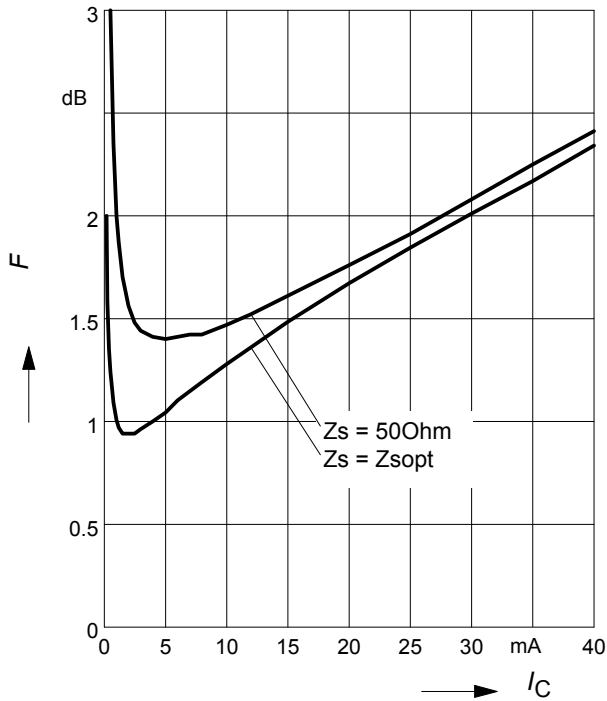

**Minimum noise figure  $NF_{min} = f(f)$**

$V_{CE} = 2\text{ V}, Z_S = Z_{Sopt}$

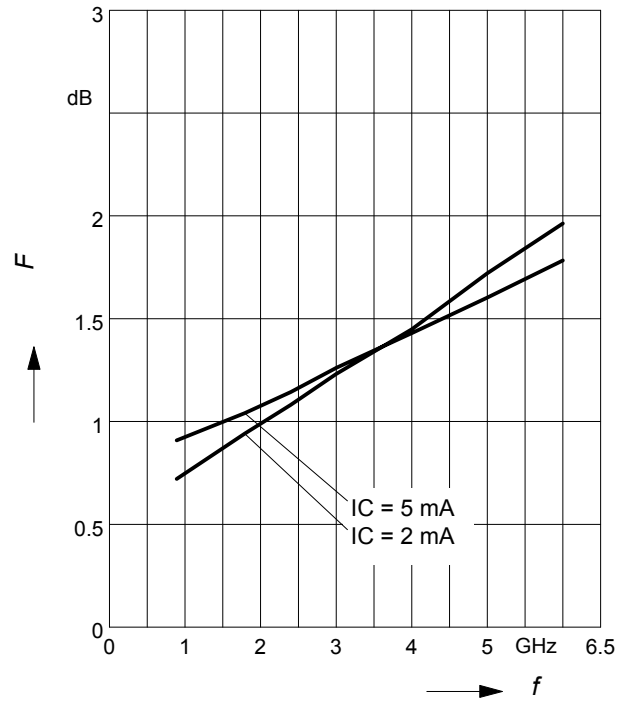

**Source impedance for min.**

**noise figure vs. frequency**

$V_{CE} = 2\text{ V}, I_C = 2\text{ mA} / 5\text{ mA}$

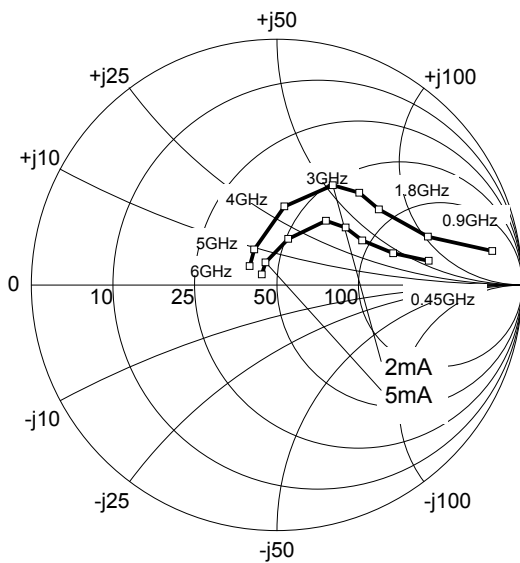

**SPICE GP Model**

For the SPICE Gummel Poon (GP) model as well as for the S-parameters (including noise parameters) please refer to our internet website [www.infineon.com/rf.models](http://www.infineon.com/rf.models).

Please consult our website and download the latest versions before actually starting your design. You find the BFP520 SPICE GP model in the internet in MWO- and ADS-format, which you can import into these circuit simulation tools very quickly and conveniently. The model already contains the package parasitics and is ready to use for DC and high frequency simulations. The terminals of the model circuit correspond to the pin configuration of the device. The model parameters have been extracted and verified up to 10 GHz using typical devices. The BFP520 SPICE GP model reflects the typical DC- and RF-performance within the limitations which are given by the SPICE GP model itself. Besides the DC characteristics all S-parameters in magnitude and phase, as well as noise figure (including optimum source impedance, equivalent noise resistance and flicker noise) and intermodulation have been extracted.

Package Outline

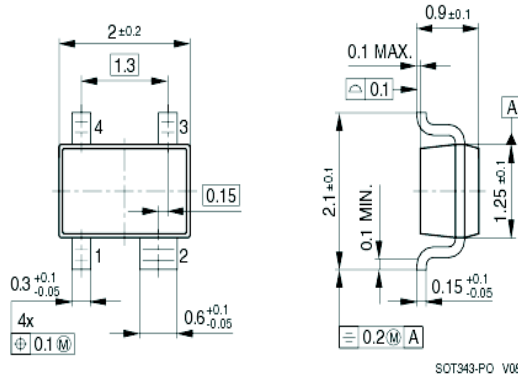

Foot Print

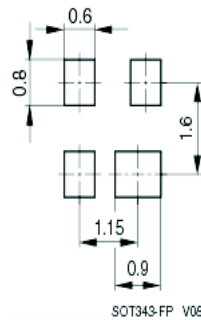

Marking Layout (Example)

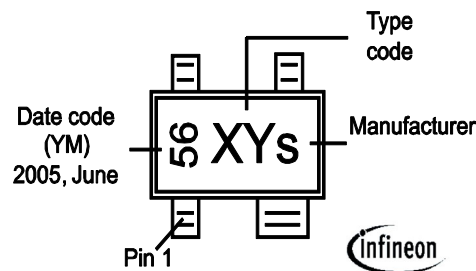

Standard Packing

Reel Ø180 mm = 3.000 Pieces/Reel  
 Reel Ø330 mm = 10.000 Pieces/Reel

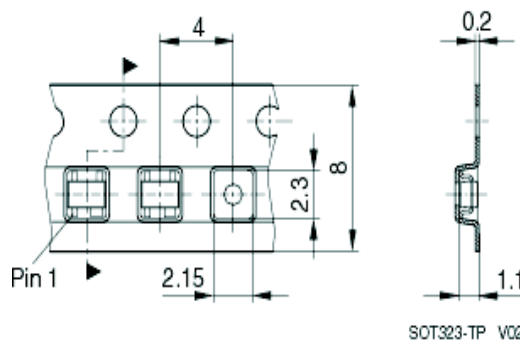

Package SOT 343.vsd



**Edition 2009-11-16**

**Published by  
Infineon Technologies AG  
81726 Munich, Germany**

**© 2009 Infineon Technologies AG  
All Rights Reserved.**

### **Legal Disclaimer**

The information given in this document shall in no event be regarded as a guarantee of conditions or characteristics. With respect to any examples or hints given herein, any typical values stated herein and/or any information regarding the application of the device, Infineon Technologies hereby disclaims any and all warranties and liabilities of any kind, including without limitation, warranties of non-infringement of intellectual property rights of any third party.

### **Information**

For further information on technology, delivery terms and conditions and prices, please contact the nearest Infineon Technologies Office ([www.infineon.com](http://www.infineon.com)).

### **Warnings**

Due to technical requirements, components may contain dangerous substances. For information on the types in question, please contact the nearest Infineon Technologies Office.

Infineon Technologies components may be used in life-support devices or systems only with the express written approval of Infineon Technologies, if a failure of such components can reasonably be expected to cause the failure of that life-support device or system or to affect the safety or effectiveness of that device or system. Life support devices or systems are intended to be implanted in the human body or to support and/or maintain and sustain and/or protect human life. If they fail, it is reasonable to assume that the health of the user or other persons may be endangered.