

# ARIO-C-MT

## Modbus/TCP Compatible

User Manual MTO-ARIOCMTU1-V2.0-2200US

Thank you for purchasing an Autonics product.

This user manual contains information about the product and its proper use, and should be kept in a place where it will be easy to access.

**Autonics**



# Contents

<b>Preface</b> .....	<b>5</b>
<b>Manual Guide</b> .....	<b>7</b>
<b>Common Symbols in the Manual</b> .....	<b>9</b>
<b>Safety Considerations</b> .....	<b>11</b>
<b>1. Reference Manuals</b> .....	<b>13</b>
<b>2. Overview of the ARIO-C-MT</b> .....	<b>15</b>
2.1. Modbus/TCP Protocol .....	15
2.2. Unit Descriptions .....	16
2.3. Ethernet Communication Connector .....	18
2.4. Assign the IP Address .....	19
2.4.1. Assign the IP address in the DAQMaster .....	20
2.5. Connections of the Power Terminal .....	21
<b>3. Indicators</b> .....	<b>23</b>
3.1. LEDs for the Coupler Status .....	24
3.2. LEDs for the Field Network Status .....	26
3.3. LEDs for the Ethernet Status .....	26
<b>4. Process Images</b> .....	<b>29</b>
4.1. Memory Map .....	29
4.2. Data Processing in the Modules .....	30
4.2.1. Check the Data of the Modules .....	31
4.3. Example of the Process Image .....	32
4.3.1. Input Process Image .....	34
4.3.2. Output Process Image .....	34
4.3.3. Mapping of the Coupler Diagnostic Data .....	35
<b>5. Function Codes</b> .....	<b>37</b>
5.1. 04 (0x04) Read Input Register (3x) .....	38
5.1.1. The Model Information .....	38
5.1.2. The Number of Modules .....	38
5.1.3. The Diagnostic Data of Coupler .....	38
5.1.4. The Configuration Information of Coupler .....	39
5.1.5. The Input Data .....	40

5.2. 03 (0x03) Read Holding Register (4x).....	41
5.2.1. The Configuration Information of Coupler.....	41
5.2.2. Read the Output Data.....	42
5.3. 06 (0x06) Write Single Register / 16 (0x10) Write Multiple Registers.....	43
5.3.1. Write the Output Data.....	43
<b>6. DAQMaster .....</b>	<b>45</b>
6.1. Configure the Modbus/TCP.....	45
6.1.1. Before You Begin.....	45
6.1.2. Add Registers.....	47
6.1.3. Add Tags.....	53
6.1.4. Monitor the Data.....	55
6.2. Monitor the ARIO Unit.....	56
6.3. Update the Firmware Version.....	59
<b>7. Dimensions .....</b>	<b>61</b>
<b>8. Specifications .....</b>	<b>63</b>
8.1. Electrical/Mechanical Specifications.....	63
8.2. Environmental Conditions.....	64
<b>9. Communication Interface .....</b>	<b>65</b>
9.1. Ethernet.....	65
9.2. ABUS.....	65

# Preface

Thank you for purchasing Autonics products.

Be sure to read and follow the **Safety Precautions** thoroughly before use.

This manual contains information about the product and how to use it properly, so keep it in a place where users can easily find it.



# Manual Guide

- Use the product after fully reading the contents of the manual.
- The manual explains the product functions in detail and does not guarantee the contents other than the manual.
- Any or all of the manual may not be edited or copied without permission.
- The manual is not provided with the product.
- Download and use from our website ([www.autonics.com](http://www.autonics.com)).
- The contents of the manual are subject to change without prior notice according to the improvement of the product's performance, and upgrade notices are provided through our website.
- We put a lot of effort to make the contents of the manual a little easier and more accurate. Nevertheless, if you have any corrections or questions, please feel free to comment through our website.





# Common Symbols in the Manual



Failure to follow instructions may result in serious injury or death.



Failure to follow instructions may result in injury or product damage.



Supplementary explanation of the function



Example of that function



Important information about the feature



# Safety Considerations

Observe all 'Safety Considerations' for safe and proper operation to avoid hazards.

---

## Warning

1. Fail-safe device must be installed when using the unit with machinery that may cause serious injury or substantial economic loss. (e.g., nuclear power control, medical equipment, ships, vehicles, railways, aircraft, combustion apparatus, safety equipment, crime/disaster prevention devices, etc.) Failure to follow this instruction may result in personal injury, fire or economic loss.
  2. Do not use the unit in the place where flammable/explosive/corrosive gas, high humidity, direct sunlight, radiant heat, vibration, impact, or salinity may be present. Failure to follow this instruction may result in explosion or fire.
  3. Do not disassemble or modify the unit. Failure to follow this instruction may result in fire.
  4. Do not connect, repair, or inspect the unit while connected to a power source. Failure to follow this instruction may result in fire.
  5. Check 'Connections' before wiring. Failure to follow this instruction may result in fire.
- 

## Caution

1. Use the unit within the rated specifications. Failure to follow this instruction may result in fire or shortening the life cycle of the product.
  2. Use dry cloth to clean the unit, and do not use water or organic solvent. Failure to follow this instruction may result in fire or electric shock.
  3. When connecting the power input and output, use AWG 22-16 cable and check the connecting method of crimp terminal. Failure to follow this instruction may result in fire or malfunction due to contact failure.
  4. Keep metal chip, dust, and wire residue from flowing into the unit. Failure to follow this instruction may result in fire or product damage.
  5. Do not connect or disconnect connector (terminal) wire or power, when the product is operating. Failure to follow this instruction may result in fire or malfunction of the product.
-

## Cautions during Use

1. Follow instructions in 'Cautions during Use'. Otherwise, It may cause unexpected accidents.
2. BUS power and I/O power should be insulated by the individually insulated power device.
3. Power supply should be insulated and limited voltage/current or Class 2, SELV power supply device.
4. Use the rated standard cables and connectors. Do not apply excessive power when connecting or disconnecting the connectors of the product.
5. Keep away from high voltage lines or power lines to prevent inductive noise.  
In case installing power line and input signal line closely, use line filter or varistor at power line and shielded wire at input signal line. For stable operation, use shield wire and ferrite core, when wiring communication wire, power wire, or signal wire.
6. Do not use near the equipment which generates strong magnetic force or high frequency noise.
7. Do not touch the module communication connector part of the base.
8. Do not connect, or remove the base while connected to a power source.
9. For removing the terminal, body or base, do not operate units for a long time without it.
10. This unit may be used in the following environments.
  - ① Indoors (in the environment condition rated in 'Specifications')
  - ② Altitude max. 2,000 m
  - ③ Pollution degree 2
  - ④ Installation category II

---

The specifications and dimensions of this manual are subject to change without any notice for product improvement. Be sure to read and follow the considerations written in the instruction manual, other manuals, and technical information on our Autonics website.

# 1. Reference Manuals



Be sure to read the reference manuals below to use the product correctly and follow the precautions written in these manuals.

You can download the reference manuals on our Autonics website.

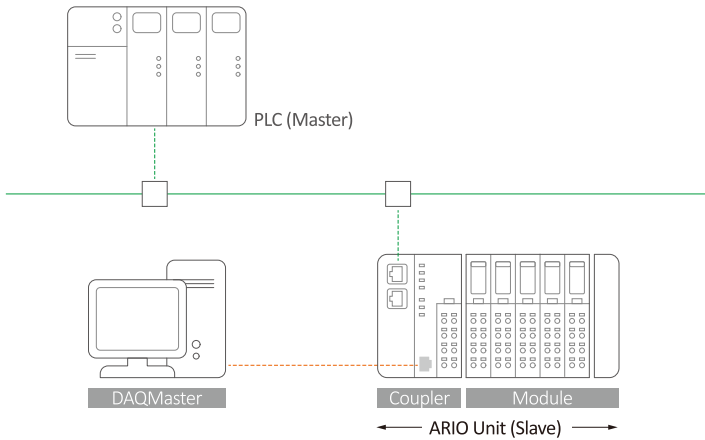

## Installation manual

It contains information for you to setup and install the ARIO Unit.

1. Key features of ARIO Series
2. Environmental conditions and handling method for installation
3. Installation precautions
4. Instructions about maintenance, etc.

**Coupler manual**

It contains information for you to configure and use the coupler in the field network.

1. Communication protocol overview
2. Hardware information: specifications, indicators, connection diagram, and dimensions, etc.
3. Software information: process images, and mapping information, etc.

**Module manual**

It contains information on the modules provided by Autonics.

1. Hardware information: specifications, indicators, connection diagram, and dimensions, etc.

**DAQMaster user manual**

It contains information and usage guides on ARIO-related functions supported by DAQMaster, the comprehensive device management program.

1. Change properties of the coupler and modules
2. Module configuration via virtual mode
3. Check the address map of the Unit
4. Check the diagnostic information of the coupler
5. Update the firmware version of the coupler, etc.

## 2. Overview of the ARIO-C-MT

### 2.1. Modbus/TCP Protocol

The Modbus protocol is commonly used to connect industrial devices because it is relatively easy to implement and can be communicated with robust connections. The versions of Modbus are categorized based on Ethernet and Serial communication: The Modbus/TCP is the protocol for Ethernet-based communication, using TCP which is a transport control layer, and IP which is an Internet layer. The Modbus uses these layers to transmit node information.

The ARIO-C-MT supports the Modbus/TCP protocol. This coupler composes the physical structure of connected modules and devices and creates input and output process images linked with the data of Modbus/TCP. The process images make it possible to experience a flexible installation environment, such as the mixed arrangement of analog and digital modules.

## 2.2. Unit Descriptions

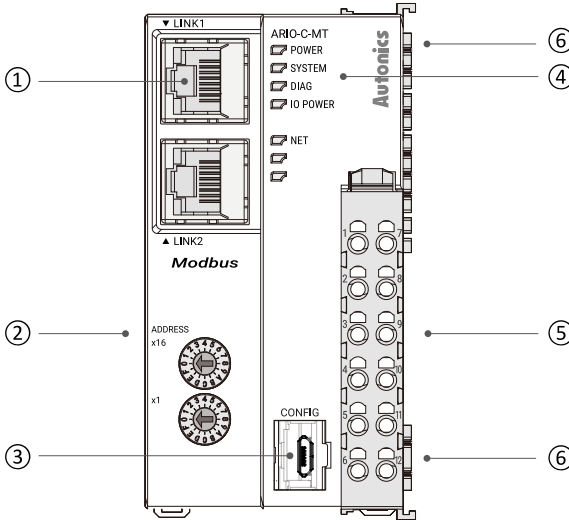

### 1. Ethernet Communication Connectors

It is a connector to connect with Modbus Master (Client) such as PLC.

For detailed information on the communication cable, refer to the 2.3, “Ethernet Communication Connector”.

### 2. Hexadecimal Rotary Switches

It is a setting switch to designate the IP address of the coupler in the Modbus communication network. You can also set the IP address in the DAQMaster.

For detailed information on addressing method, refer to the 2.4, “Assign the IP Address”.

### 3. CONFIG Port

It is a port to connect to the PC where DAQMaster is installed.

1. Port type: USB Type-B Micro



#### **4. Indicators**

It displays the status of the coupler and communication connection as shown below. For detailed information on the indicators, refer to the 3, Indicators.

1. Power and operating status of the coupler
2. Modbus communication status

#### **5. Power Supply Terminal**

It is a terminal block that supplies power to the coupler and peripherals. For detailed information on the device supply, refer to the 2.5, “Connections of the Power Terminal”.

#### **6. Power Supply Contacts**

It is a contact that feeds the power input from the power supply terminal.

1. Top input contacts: feed the power supply for the coupler, module, and ABUS to be operated.
2. Bottom input contacts: feed the power supply for input and output signals of the connected module.

## 2.3. Ethernet Communication Connector



- Be sure to use the connector and cable approved by the Modbus Organization. Otherwise, use an Ethernet connector and cable that meets the specifications of at least category 5e.
- Be sure not to exceed the cable length of 100 meters.

The RJ45 connector is used for Modbus/TCP communication connection. For more information on the pin assignment, refer to the table below.

### ▼ LINK1

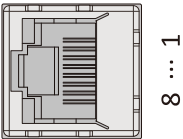
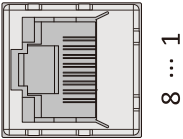

### ▲ LINK2

Pin no.	Color of conductor based on T568A	Signal	Description
1	Green/White	TD +	Transmit Data +
2	Green	TD -	Transmit Data -
3	Orange/White	RD +	Receive Data +
6	Orange	RD -	Receive Data -

## 2.4. Assign the IP Address



- It is recommended to designate the IP address of the coupler the same as the value of the rotary switches.
- The IP address cannot be applied while the coupler is operating.
- Be sure to start the coupler again to apply the changed IP address.
- The IP addresses of the master and coupler should be the same up to the network area of the subnet mask. For more information on the range of IP addresses in each class, refer to the table below.

Class	Default subnet mask	IP address range (Master = Coupler)
A	255.0.0.0	The first octet
B	255.255.0.0	The first to second octets
C	255.255.255.0	The first to third octets

You can assign the coupler's IP address via two hexadecimal rotary switches.

The last octet of the IP address is changed.

ADDRESS

x16

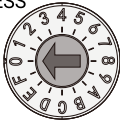

x1



Assign mode	Rotary switches (x16, x1)	Value
Default IP address	0x00	Factory setting: 192.168.2.3
IP address	0x01 to 0xFF	192.168.2.1 to 192.168.2.255

### 2.4.1. Assign the IP address in the DAQMaster

1. Set the positions of the coupler's rotary switches to 0x00.
2. To designate the IP address in the DAQMaster, go to the **Comm Mode » Property tab of the coupler » Coupler IP(Node Address)** and press the Enter key.
3. Reset the ARIO unit in the DAQMaster.
4. The IP address assigned by the DAQMaster is applied.

## 2.5. Connections of the Power Terminal

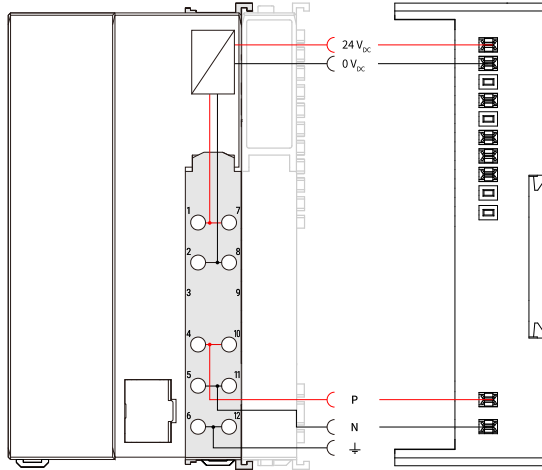

Terminal no.	Name	Description
1, 7	System Power (24 V <sub>DC</sub> )	Power supply for the coupler, module and ABUS to be operated.
2, 8	System Power (0 V <sub>DC</sub> )	<ul style="list-style-type: none"> <li>• The terminals feed the power supply to the top input contacts.</li> <li>• The POWER indicator lights up.</li> </ul>
3, 9	Not Connected (NC)	-
4, 10	Field Power (Positive: 24 V <sub>DC</sub> )	Power supply for the input and output (I/O) signals of the module.
5, 11	Field Power (Negative: 0 V <sub>DC</sub> )	<ul style="list-style-type: none"> <li>• The terminals feed the power supply to the bottom input contacts.</li> <li>• The IO POWER indicator lights up.</li> </ul>
6, 12	Frame Ground / Shield	Frame ground



# 3. Indicators

The indicators of the ARIO-C-MT coupler consist of elements indicating the operating status for the coupler, and connection status for the field network (Modbus/TCP) and Ethernet as shown in the figure below. For detailed information on each indicator, refer to the following tables below.

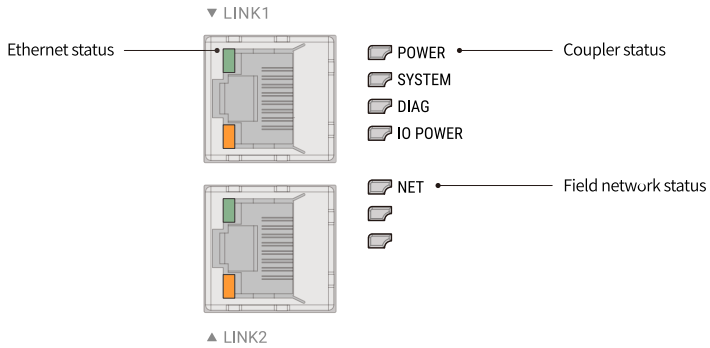

## 3.1. LEDs for the Coupler Status

### 1. The power supply status of the coupler

Indicator	LED color	Status	Description
POWER	Green	ON	Supply voltage: Normal
		OFF	Supply voltage: None

### 2. The status of the standby mode

Indicator	LED color	Status	Description
SYSTEM	Green	ON	Normal operation
		Flashing	Standby for connecting the master after initialization of the coupler
		OFF	Stop
	Red	ON	<ul style="list-style-type: none"> <li>Coupler initialization failure (non-recoverable)</li> <li>An unrecoverable error occurred.</li> <li>The type of field network and firmware version mismatch (non-recoverable)</li> </ul>
		Flashing	<ul style="list-style-type: none"> <li>Field network initialization failure (non-recoverable)</li> <li>Changing the settings of rotary switches (applicable models)</li> </ul>
		OFF	Normal operation

### 3. The status of the module communication (ABUS)

Indicator	LED color	Status	Description
DIAG	Green	ON	Normal operation: Multi/Single-packet works
		Flashing	Hot-swap (normal state)
		OFF	<ul style="list-style-type: none"> <li>The operation of the coupler stopped</li> <li>An error occurred</li> </ul>
	Red	ON	ABUS communication error
		Flashing	The models of the replaced module and the previous one mismatch (normal operation)
		Flashing (2 times)	No module connection (non-recoverable)
		Flashing (3 times)	Abnormal module operation (non-recoverable)
		Flashing (4 times)	The number of modules and data size exceeded
		OFF	Normal operation



#### 4. The status of power supply for the module

Indicator	LED color	Status	Description
IO POWER	Green	ON	Supply voltage for the I/O signals of modules : Normal
		OFF	Supply voltage for the I/O signals of modules : None

### 3.2. LEDs for the Field Network Status

1. The status of the Modbus/TCP communication and error

Indicator	LED color	Status	Description
NET	Green	ON	Physical and communication connection completed
		Flashing	Disconnected when attempting communication <ul style="list-style-type: none"> <li>Configuring the Connection uncompleted or an error occurred</li> </ul>
		OFF	INIT state (Modbus/TCP communication initialized, communication unavailable)
	Red	ON	Critical failure or communication connection error <ul style="list-style-type: none"> <li>Network error</li> <li>Duplicate MAC address detected</li> </ul>
		Flashing	Minor failure or connection timeout <ul style="list-style-type: none"> <li>Data exchange time exceeded</li> <li>Communication establishment time exceeded</li> <li>No connected slave</li> <li>No supply power for network establishment</li> </ul>
		OFF	<ul style="list-style-type: none"> <li>Supply voltage: None</li> <li>Devices offline or no supply power for network</li> <li>MAC address validation test (Dup_MAC_ID test) in progress</li> </ul>

### 3.3. LEDs for the Ethernet Status

1. The status of the Ethernet connection

Indicator	LED color	Status	Description
LINK 1, 2	Green	ON	<b>Link:</b> The device is linked to the Ethernet.
		OFF	The device has no link to the Ethernet.
	Orange	Flashing	<b>Activity:</b> The device sends/receives Ethernet frames.
		OFF	The device does not send/receive Ethernet frames.



Refer to the timing chart below for the flashing operation of indicators.  
The operation is repeated as flashing every 200 microseconds and standby for 1 second.

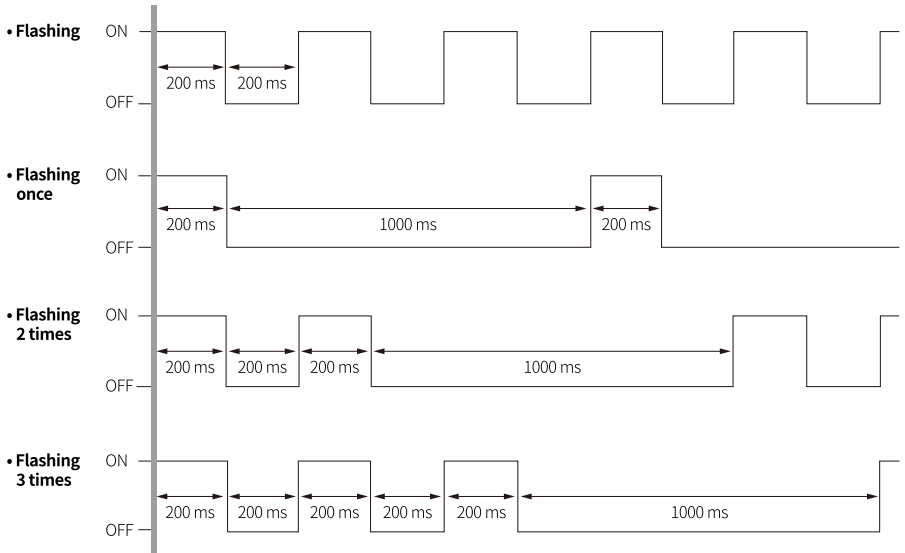



# 4. Process Images

## 4.1. Memory Map

The ARIO unit composes the memory map in its memory space to assign and manage the data collected by the coupler and modules. The master in the field network controls the input and output devices via this memory map generated by the ARIO unit.

The memory map is created based on the arrangement and data structure of the ARIO unit as shown in the figure below. The memory map of modules consists of each module and contains its data. The memory map of the coupler allocates the data considering the type (input or output) and sequence of connected modules (e.g., the slot number of each module), and data size to the read and write areas, making it easy to calculate the location of the master's register. In this way, the memory map comprised by the ARIO unit creates the input and output process images for data exchange.

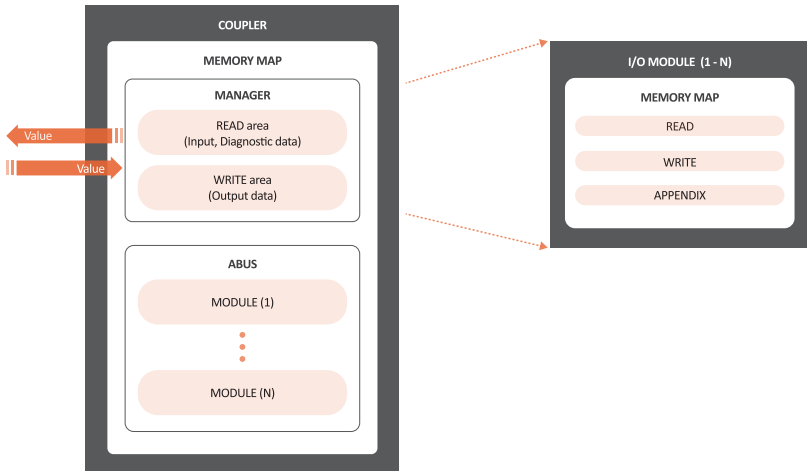

- **READ area**  
It is the area that transmits the data collected by the unit to the master in the field network. It contains the input and diagnostic data.
- **WRITE area**  
It is the area that transmits the output commands from the master of the field network. It contains the output data.

## 4.2. Data Processing in the Modules

The data of the module is processed depending on the input and output signals.

- **Digital modules**

The bit-oriented digital module indicates the value of the corresponding bit position as 1.

The size of each channel is 1 bit and is grouped into bytes.

- **Analog modules**

The byte-oriented analog module indicates the value of the input or output signal to the corresponding bytes. The size of each channel is grouped into words.

Module	Example of input/output format	Data processing size
Digital input/output : Bit-oriented	2 channels/module (2-CH/module)	1-byte
	4 channels/module (4-CH/module)	1-byte
	8 channels/module (8-CH/module)	1-byte
	16 channels/module (16-CH/module)	2-byte (= 1-word)
Analog input/output : Byte-oriented	8-bit/channel (8-bit/CH)	1-byte
	12-bit/channel (12-bit/CH)	2-byte (= 1-word)
	16-bit/CH (16-bit/CH)	2-byte (= 1-word)
	24-bit/channel (24-bit/CH)	4-byte (= 2-word)

### 4.2.1. Check the Data of the Modules

You can check the data of modules connected with the coupler as shown in the figure below. To check the data, go to **Comm Mode » Run » I/O Monitor** in the DAQMaster. The binary, decimal, and hexadecimal are supported as the display format in the DAQMaster.

1. The value of input signals on the point (or channels) 1 and 2 of the digital input module
  - **Binary 0000 0011 (0x03)**

Slot Number	Module Name	Type	Channel	Data	Diagnostic Byte
1	DI08N	R	8	0x03	
	Point 1			1	
	Point 2			1	
	Point 3			0	
	Point 4			0	
	Point 5			0	
	Point 6			0	
	Point 7			0	
	Point 8			0	

2. The value of a voltage of 10.000 V applied to channel 1 of the analog input module
  - **Big endian: 0x270D (≈ 10,000<sub>DEC</sub>)**

Slot Number	Module Name	Type	Channel	Data	Diagnostic Byte
1	AI04V1	R	4	0x270D 0003 0003 0000	
	Channel 1			0x270D	
	Channel 2			0x0003	
	Channel 3			0x0003	
	Channel 4			0x0000	
2	AO04V1	W	4	0x2710 0000 0000 0000	
	Channel 1			0x2710	
	Channel 2			0x0000	
	Channel 3			0x0000	
	Channel 4			0x0000	



The data arrangements (the order or sequence) of the analog signal can be expressed as big-endian or little-endian in the DAQMaster.

To select the endianness, go to **Comm Mode » Property tab of the coupler » Endian**. (factory setting: Big-endian)

### 4.3. Example of the Process Image

You can check the input and output process images of the unit (coupler + modules) on the **AddressMap** menu in the DAQMaster. Firstly, the input modules are mapped, and then the output modules are mapped. The first position of the input process image contains diagnostic information of the coupler with a size of 16 bits (1 word).

The process image of the Modbus protocol is expressed as big-endian (MSB → LSB) of 16 bits and consists of the input register and holding register.

#### DAQMaster: An arrangement example of the ARIO unit

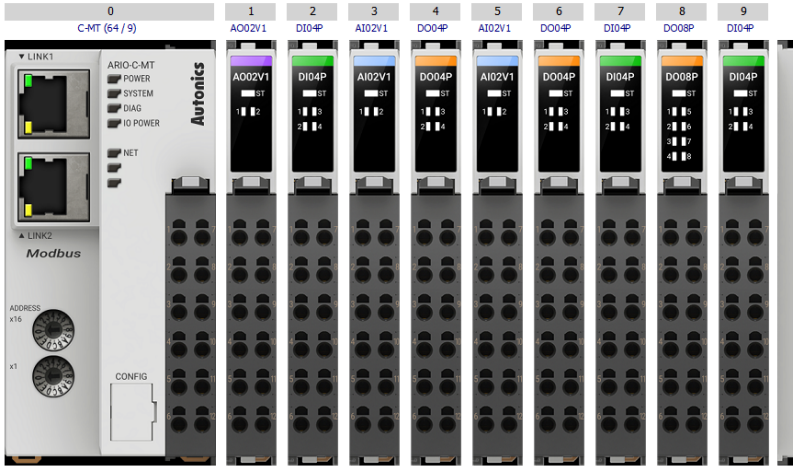



## DAQMaster: The address map of the ARIO unit

- Protocol Address (Base 0)

Slot Number : Module Name	Address	Type	F	E	D	C	B	A	9	8	7	6	5	4	3	2	1	0
3 : AI02V1 - Channel 1_2 : DI0#P	302000 (0x07CF)	R					P3	P2	P1	P0	C1H	C1H	C1H	C1H	C1H	C1H	C1H	C1H
3 : AI02V1 - Channel 1	302001 (0x07D0)	R	C1L	C1L	C1L	C1L	C1L	C1L	C1L	C1L	C2H	C2H	C2H	C2H	C2H	C2H	C2H	C2H
5 : AI02V1 - Channel 1_3 : AI02V1 - Channel 1	302002 (0x07D1)	R	C2L	C2L	C2L	C2L	C2L	C2L	C2L	C2L	C1H	C1H	C1H	C1H	C1H	C1H	C1H	C1H
5 : AI02V1 - Channel 1	302003 (0x07D2)	R	C1L	C1L	C1L	C1L	C1L	C1L	C1L	C1L	C2H	C2H	C2H	C2H	C2H	C2H	C2H	C2H
7 : DI0#P_5 : AI02V1 - Channel 1	302004 (0x07D3)	R					P3	P2	P1	P0	C2L	C2L	C2L	C2L	C2L	C2L	C2L	C2L
9 : DI0#P	302005 (0x07D4)	R														P3	P2	P1
1 : AO02V1 - Channel 1	402000 (0x07CF)	W	C1H	C1H	C1H	C1H	C1H	C1H	C1H	C1H	C1L	C1L	C1L	C1L	C1L	C1L	C1L	C1L
1 : AO02V1 - Channel 2	402001 (0x07D0)	W	C2H	C2H	C2H	C2H	C2H	C2H	C2H	C2H	C2L	C2L	C2L	C2L	C2L	C2L	C2L	C2L
6 : DO0#P_4 : DO0#P	402002 (0x07D1)	W					P3	P2	P1	P0						P3	P2	P1
8 : DO08P	402003 (0x07D2)	W									P7	P6	P5	P4	P3	P2	P1	P0

- PLC Address (Base 1)

Slot Number : Module Name	Address	Type	F	E	D	C	B	A	9	8	7	6	5	4	3	2	1	0
3 : AI02V1 - Channel 1_2 : DI0#P	302001 (0x07D0)	R					P3	P2	P1	P0	C1H	C1H	C1H	C1H	C1H	C1H	C1H	C1H
3 : AI02V1 - Channel 1	302002 (0x07D1)	R	C1L	C1L	C1L	C1L	C1L	C1L	C1L	C1L	C2H	C2H	C2H	C2H	C2H	C2H	C2H	C2H
5 : AI02V1 - Channel 1_3 : AI02V1 - Channel 1	302003 (0x07D2)	R	C2L	C2L	C2L	C2L	C2L	C2L	C2L	C2L	C1H	C1H	C1H	C1H	C1H	C1H	C1H	C1H
5 : AI02V1 - Channel 1	302004 (0x07D3)	R	C1L	C1L	C1L	C1L	C1L	C1L	C1L	C1L	C2H	C2H	C2H	C2H	C2H	C2H	C2H	C2H
7 : DI0#P_5 : AI02V1 - Channel 1	302005 (0x07D4)	R					P3	P2	P1	P0	C2L	C2L	C2L	C2L	C2L	C2L	C2L	C2L
9 : DI0#P	302006 (0x07D5)	R														P3	P2	P1
1 : AO02V1 - Channel 1	402001 (0x07D0)	W	C1H	C1H	C1H	C1H	C1H	C1H	C1H	C1H	C1L	C1L	C1L	C1L	C1L	C1L	C1L	C1L
1 : AO02V1 - Channel 2	402002 (0x07D1)	W	C2H	C2H	C2H	C2H	C2H	C2H	C2H	C2H	C2L	C2L	C2L	C2L	C2L	C2L	C2L	C2L
6 : DO0#P_4 : DO0#P	402003 (0x07D2)	W					P3	P2	P1	P0						P3	P2	P1
8 : DO08P	402004 (0x07D3)	W									P7	P6	P5	P4	P3	P2	P1	P0

### 4.3.1. Input Process Image

Byte		Bit 7	Bit 6	Bit 5	Bit 4	Bit 3	Bit 2	Bit 1	Bit 0
0	0: Coupler	Diagnostic Data High Byte <sup>01)</sup>							
1		Diagnostic data Low Byte <sup>01)</sup>							
2	2: DI04P	-				Ch.4	Ch.3	Ch.2	Ch.1
3	3: AI02V1	Ch.1 High Byte							
4		Ch.1 Low Byte							
5		Ch.2 High Byte							
6		Ch.2 Low Byte							
7	5: AI02V1	Ch.1 High Byte							
8		Ch.1 Low Byte							
9		Ch.2 High Byte							
10		Ch.2 Low Byte							
11	7: DI04P	-				Ch.4	Ch.3	Ch.2	Ch.1
12	9: DI04P	-				Ch.4	Ch.3	Ch.2	Ch.1

01) Refer to the 4.3.3, "Mapping of the Coupler Diagnostic Data".

### 4.3.2. Output Process Image

Byte		Bit 7	Bit 6	Bit 5	Bit 4	Bit 3	Bit 2	Bit 1	Bit 0
0	1: AO02V1	Ch.1 High Byte							
1		Ch.1 Low Byte							
2		Ch.2 High Byte							
3		Ch.2 Low Byte							
4	4: DO04P	-				Ch.4	Ch.3	Ch.2	Ch.1
5	6: DO04P	-				Ch.4	Ch.3	Ch.2	Ch.1
6	8: DO08P	Ch.8	Ch.7	Ch.6	Ch.5	Ch.4	Ch.3	Ch.2	Ch.1

### 4.3.3. Mapping of the Coupler Diagnostic Data

To check the value of the coupler diagnosis in the DAQMaster, go to **Comm Mode » Property tab of the coupler » Coupler State**.

Byte		Bit 7	Bit 6	Bit 5	Bit 4	Bit 3	Bit 2	Bit 1	Bit 0
0	High	Reserved							
1	Low	CS	MS	WP	AEM	-	ACS	AT	AC

#### AC (ABUS Configuration)

The diagnostic information for the configuration of the coupler and modules

0: Normal state

1: Module configuration error

- Cause 1: No connected modules
- Cause 2: The number of connected modules exceeded
- Cause 3: The data size of module exceeded
- Cause 4: Invalid arrangement of modules

#### AT (ABUS Timeout)

The occurrence information of timeout

0: Multi-packet state (normal)

1: Single-packet state (timeout occurred)

- Cause 1: The module detached
- Cause 2: The module not recognized due to a noise
- Cause 3: Hot-swap state
- Cause 4: The module operation error

#### ACS (ABUS Communication State)

ABUS communication status

0: Normal state

1: Communication error

- Cause 1: Replaced module mismatched
- Cause 2: Unknown communication error occurred

#### AEM (ABUS Empty Module)

Checking the connected module

0: Normal state (one or more modules connected)

1: No module connected

#### WP (Warranty Period)

Notice of product warranty period

( $\leq 3$  years, 157,680<sub>DEC</sub>)

0: Within the warranty period

1: End of warranty period

**MS (Module State)**

The status of connected modules  
(running with DIAG indicator)

0: Normal state

1: Error

**CS (Coupler State)**

The information on the coupler state  
(running with SYSTEM indicator)

0: Normal state

1: Error

- Cause 1: Error occurred in the coupler initialization and settings, etc.

- Cause 2: Error occurred in the field network connection, etc.

# 5. Function Codes

The following tables describe the data model and public function codes for the Modbus protocol supported by the ARI0-C-MT.

- **Data model**

Modbus data	Access unit	Reference no.	Function code	Data type
Input Registers	Word (16-bit)	3x	04	RO
Holding Registers	Word (16-bit)	4x	03, 06, 16	RW

- **Public function codes**

Function	Function code	Register range	Service
Read	04 Read Input Register	00101 to 00114	The data of model information is returned.
		00126	The number of connected modules is returned.
		01024	The diagnostic data of the coupler is returned.
		01034 to 01087	The configuration data of the coupler is returned.
		02001 to 02256	The input data is returned.
	03 Read Holding Register	01034 to 01087	The configuration data of the coupler is returned.
		02001 to 02256	The output data is returned.
Write	06 Write Single Register, 16 Write Multiple Registers	02001 to 02256	It writes the output data.

## 5.1. 04 (0x04) Read Input Register (3x)

It reads the data of the input register in the coupler.

### 5.1.1. The Model Information

Data	Register	Value
Product number: High	300101 (0x0064)	0x1028
Product number: Low	300102 (0x0065)	0x0001
Hardware version (10 = V1.0)	300103 (0x0066)	10
Software/firmware version (10 = V1.0)	300104 (0x0067)	10
Model name: 1	300105 (0x0068)	"AR"
Model name: 2	300106 (0x0069)	"IO"
Model name: 3	300107 (0x006A)	"-C"
Model name: 4	300108 (0x006B)	"-M"
Model name: 5	300109 (0x006C)	"T"
Model name: 6	300110 (0x006D)	" "
Model name: 7	300111 (0x006E)	" "
Model name: 8	300112 (0x006F)	" "
Model name: 9	300113 (0x0070)	" "
Model name: 10	300114 (0x0071)	" "

### 5.1.2. The Number of Modules

Data	Register	Value
The number of modules connected to the coupler	300126 (0x007D)	

### 5.1.3. The Diagnostic Data of Coupler

Data	Register	Value
The diagnostic data of the coupler	301024 (0x03FF)	Refer to the 4.3.3, "Mapping of the Coupler Diagnostic Data".

## 5.1.4. The Configuration Information of Coupler

Data	Register	Value
IP address of the Modbus master (client) : 192.168.2.250	301034 (0x0409)	
	301035 (0x040A)	
	301036 (0x040B)	
	301037 (0x040C)	
IP address of the coupler (Modbus slave/server) : 192.168.2.□□□	301038 (0x040D)	192
	301039 (0x040E)	168
	301040 (0x040F)	2
	301041 (0x0410)	depends on user setting
Gateway address : 192.168.2.1	301042 (0x0411)	192
	301043 (0x0412)	168
	301044 (0x0413)	2
	301045 (0x0414)	1
TCP PORT	301046 (0x0415)	502 (default, fixed)
TCP Timeout (unit: msec, Keep Alive)	301047 (0x0416)	1000
Access allowed master IP: 1	301048 to 301051 (0x0417 to 0x041A)	
Access allowed master IP: 2	301052 to 301055 (0x041B to 0x041E)	
Access allowed master IP: 3	301056 to 301059 (0x041F to 0x0422)	
Access allowed master IP: 4	301060 to 301063 (0x0423 to 0x0426)	
Access allowed master IP: 5	301064 to 301067 (0x0427 to 0x042A)	
Access allowed master IP: 6	301068 to 301071 (0x042B to 0x042E)	
Access allowed master IP: 7	301072 to 301075 (0x042F to 0x0432)	
Access allowed master IP: 8	301076 to 301079 (0x0433 to 0x0436)	
Access allowed master IP: 9	301080 to 301083 (0x0437 to 0x043A)	
Access allowed master IP: 10	301084 to 301087 (0x043B to 0x043E)	

## 5.1.5. The Input Data

Data	Register	Value
The data from the input module	302001 to 302256 (0x07D0 to 0x08CF)	



For more information on the address of the input module, refer to the AddressMap in the DAQMaster.



## 5.2. 03 (0x03) Read Holding Register (4x)

It reads the output data of the holding register in the coupler.

### 5.2.1. The Configuration Information of Coupler

Data	Register	Value
IP address of the Modbus master (client) : 192.168.2.250	401034 (0x0409)	
	401035 (0x040A)	
	401036 (0x040B)	
	401037 (0x040C)	
IP address of the coupler (Modbus slave/server) : 192.168.2.□□□□	401038 (0x040D)	192
	401039 (0x040E)	168
	401040 (0x040F)	2
	401041 (0x0410)	depends on user setting
Gateway address : 192.168.2.1	401042 (0x0411)	192
	401043 (0x0412)	168
	401044 (0x0413)	2
	401045 (0x0414)	1
TCP PORT	401046 (0x0415)	502 (default, fixed)
TCP Timeout (unit: msec, Keep Alive)	401047 (0x0416)	1000
Access allowed master IP: 1	401048 to 401051 (0x0417 to 0x041A)	
Access allowed master IP: 2	401052 to 401055 (0x041B to 0x041E)	
Access allowed master IP: 3	401056 to 401059 (0x041F to 0x0422)	
Access allowed master IP: 4	401060 to 401063 (0x0423 to 0x0426)	
Access allowed master IP: 5	401064 to 401067 (0x0427 to 0x042A)	
Access allowed master IP: 6	401068 to 401071 (0x042B to 0x042E)	
Access allowed master IP: 7	401072 to 401075 (0x042F to 0x0432)	
Access allowed master IP: 8	401076 to 401079 (0x0433 to 0x0436)	
Access allowed master IP: 9	401080 to 401083 (0x0437 to 0x043A)	
Access allowed master IP: 10	401084 to 401087 (0x043B to 0x043E)	

## 5.2.2. Read the Output Data

Data	Register	Value
The data from the output module	402001 to 402256 (0x07D0 to 0x08CF)	



For more information on the address of the output module, refer to the AddressMap in the DAQMaster.

## 5.3. 06 (0x06) Write Single Register / 16 (0x10) Write Multiple Registers

- **06 (0x06) Write Single Register**

: It writes the single value with a size of 1 word (16-bit) to the holding register in the coupler.

- **16 (0x10) Write Multiple Registers**

: It writes the multiple values with a size of 1 word (16-bit) to the holding register in the coupler.

### 5.3.1. Write the Output Data

Data	Register	Value
The data from the output module	402001 to 402256 (0x07D0 to 0x08CF)	



For more information on the address of the output module, refer to the AddressMap in the DAQMaster.



# 6. DAQMaster

## 6.1. Configure the Modbus/TCP



- Be sure to see the version compatibility table of the ARIO Series on our Autonics website to check the software/firmware(SW) and hardware(HW) versions of the coupler and modules.
- Refer to the 6.3, “Update the Firmware Version” to update to the latest software(firmware) version.

### 6.1.1. Before You Begin

Firstly, this chapter describes how to configure Modbus/TCP communication under the connection of the DAQMaster and the Ethernet communication connector of the coupler. After that, writing the output signals on channels 1 and 2 of the digital output module, reading the input signals of the digital input module, and monitoring the data in these modules are given in this chapter.

#### Configuration of the ARIO Unit

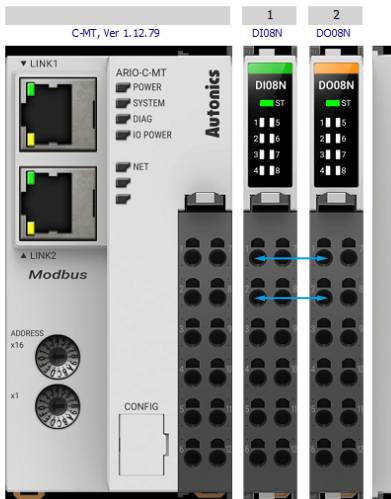

## Settings of the ARIO Coupler

- IP address of the coupler: 192.168.2.10  
Set the positions of Hexadecimal Rotary Switches to 0x0A.



Check the IP address of the coupler on the **Comm Mode » Property tab of the coupler » Coupler IP(Node Address)** in the DAQMaster.



This chapter only describes based on our software, DAQMaster.  
For detailed information on communication connection and usage method with the master, refer to the user manuals provided by the specific manufacturer.

## 6.1.2. Add Registers

1. Connect the Ethernet communication connector on the ARIO-C-MT to the PC where the DAQMaster is installed.
2. Select **Tool » Edit ModBus Device** on the top menu of the DAQMaster.
3. Select **ModBus Editor » Properties » Add**.

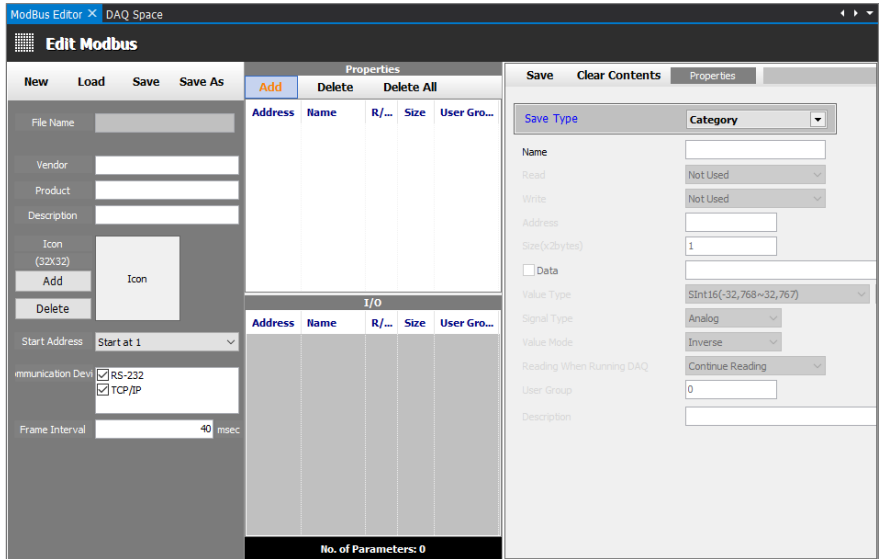

4. Set a register for reading and writing the module data as below and select the **OK**.

- Auto Add Multiple
- Save Type: I/O
- Name: Desired name (The name was similarly designated to Function Code in this chapter.)
- Read: 03 or 04
- Write: 06
- Start Address: 2001 (based on the PC)
- Value Type: UInt16 (0 to 65535)
- Signal Type: Analog fixed
- Value Mode: Normal
- Reading When Run DAQMaster: Continue Reading
- Others: Fixed values

### Example of the registers

Add

Add One     Auto Add Multiple

Save Type: I/O

Name: 03 Read 1

Read: 03 Read Holding Registers

Write: Not Used

Start Address: 2001

Value Type: UInt16(0~65,535)

AB CD

Signal Type: Analog

Value Mode: Normal

Reading When Run: Continue Reading

Start Address: 1

Add Num: 1

User Group: 0

OK    Cancel

Add

Add One     Auto Add Multiple

Save Type: I/O

Name: 06 Write 1

Read: Not Used

Write: 06 Write Single Registers

Start Address: 2001

Value Type: UInt16(0~65,535)

AB CD

Signal Type: Analog

Value Mode: Normal

Reading When Run: Continue Reading

Start Address: 1

Add Num: 1

User Group: 0

OK    Cancel



5. Enter the information about Vendor and Product at the left side of the ModBus Editor and select **Save** to save the register in your PC.

- Vendor: Desired vendor name (e.g., Autonics)
- Product: Desired product name (e.g., ARIO-C-MT)
- Start Address: Start at 1
- Communication Device: Both RS-232 and TCP/IP selected
- Frame cycle: 40 fixed
- Others: Optional

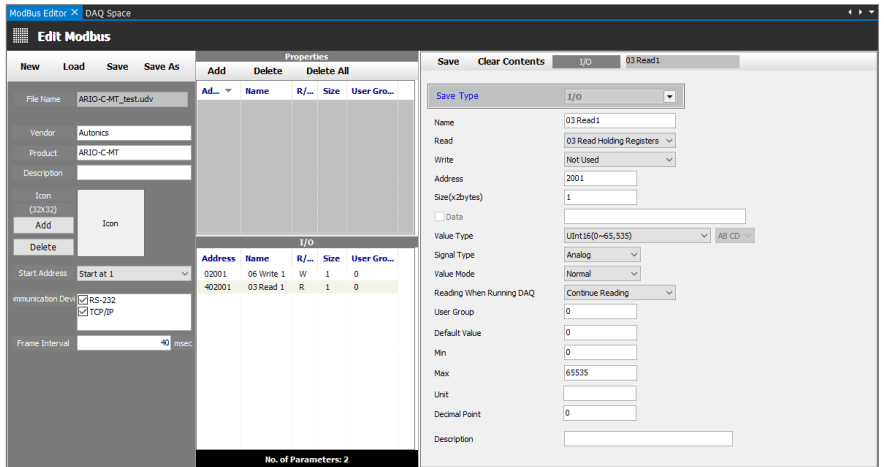

6. Right-click on the **Supported Device List** » **AUTONICS** and select **Refresh**.  
Proceed to Device Search.

7. Double-click on the **Supported Device List** » **AUTONICS** » **ARIO-C-MT**.

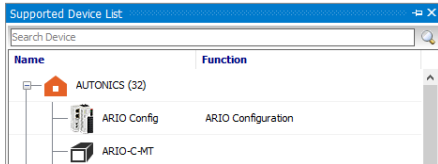

8. Select the **TCP/IP** on the DAQ Interface window and click the **OK**.

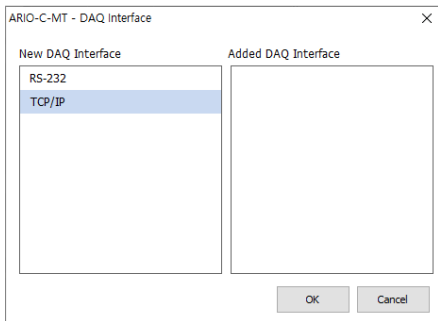

9. Select **My System** » **TCP/IP** and enter the IP address of the coupler on the **Property** » **Configuration** » **Address**.

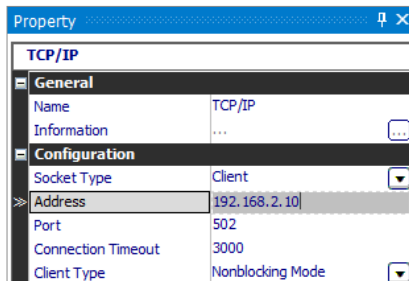
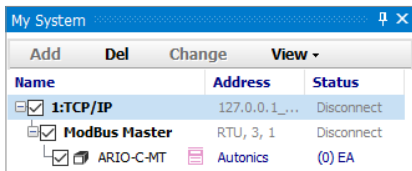

10. Select **My System » TCP/IP » ModBus Master** and also select the ModBus TCP on the **Property » Configuration » Mode**.

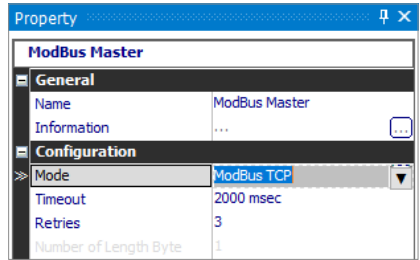
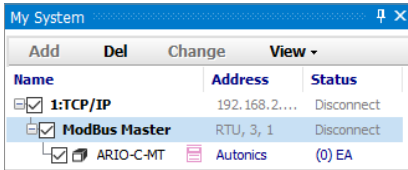

11. Right-click on the **My System » TCP/IP » ARI0-C-MT** and select the **Add**.

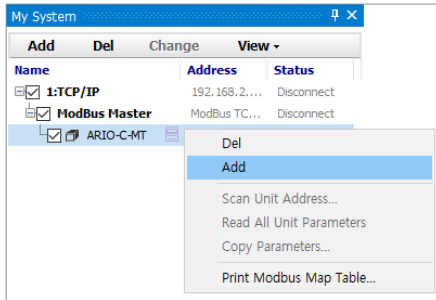

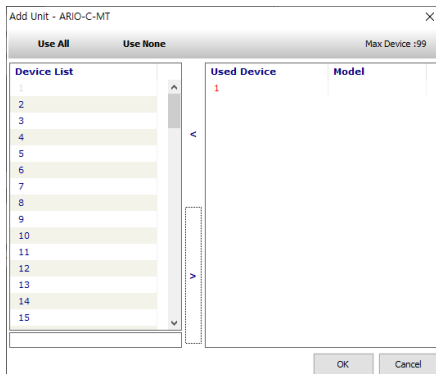

12. Select **1 (fixed)** at the Device List and click **>** to add it to the Used Device on the right side of the window. Click the **OK** to add the coupler.

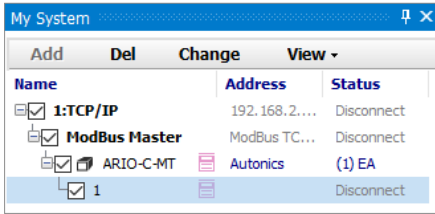

13. The coupler is added to My System as shown below.



The screenshot shows a window titled "My System" with a menu bar containing "Add", "Del", "Change", and "View". Below the menu bar is a table with three columns: "Name", "Address", and "Status". The table contains the following entries:

Name	Address	Status
<input checked="" type="checkbox"/> 1:TCP/IP	192.168.2....	Disconnect
<input checked="" type="checkbox"/> ModBus Master	ModBus TC...	Disconnect
<input checked="" type="checkbox"/>  ARIO-C-MT	 Autonics	(1) EA
<input checked="" type="checkbox"/> 1		Disconnect

### 6.1.3. Add Tags

- When selecting the **I/O List » ARIO-C-MT**, the I/O registers added on the ModBus Editor are displayed. Select the register to use, right-click and select the **Add to DAQ list**.

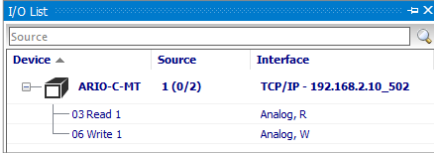

- The tags are added to the DAQ List window as shown below.

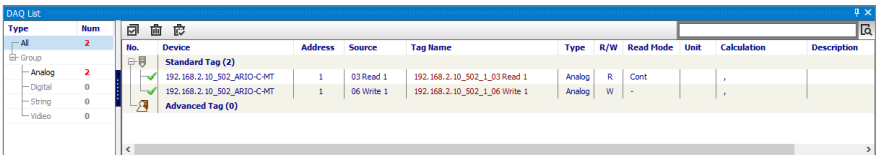

- Double-click **RunTime Screen » Data » (e.g.) Bar Graph** to configure the visualized monitoring screen. Drag and drop the tags added on the DAQ List window to the bar graph on the DAQ Space window.

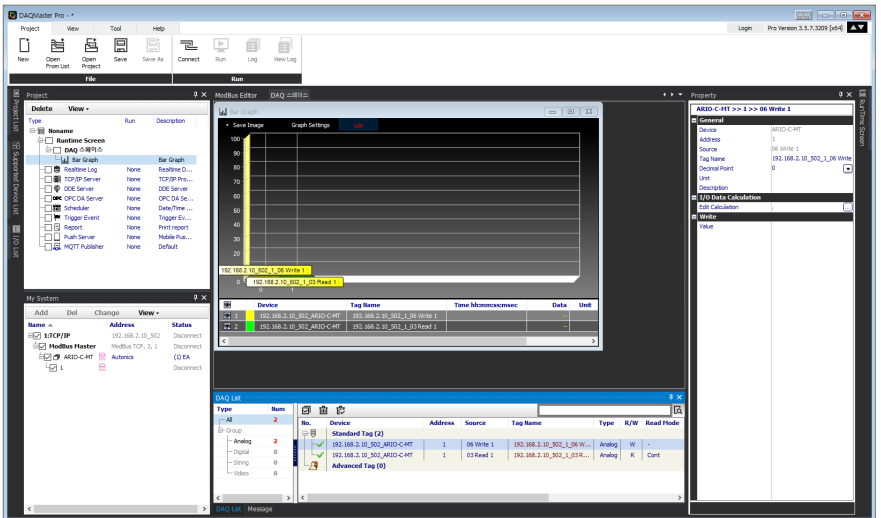

4. Select **Project » Connect » Run**. Then the green LED lights up on the NET indicator of the coupler.  
Check the connection status on the My System as shown below.

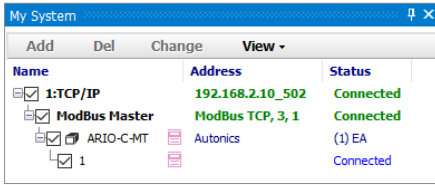

The screenshot shows a window titled "My System" with a menu bar containing "Add", "Del", "Change", and "View". Below the menu bar is a table with three columns: "Name", "Address", and "Status". The table contains the following data:

Name	Address	Status
<input checked="" type="checkbox"/> 1:TCP/IP	192.168.2.10_502	Connected
<input checked="" type="checkbox"/> ModBus Master	ModBus TCP, 3, 1	Connected
<input checked="" type="checkbox"/> ARIO-C-MT	Autonics	(1) EA
<input checked="" type="checkbox"/> 1		Connected

## 6.1.4. Monitor the Data

1. Select the tag **06 Write** on the DAQ List window to give output signals on channels 1 and 2 of the digital output module.
2. Enter **768** at the **Property » Write » Value** on the right side of the screen and press the Enter key.  
You can see that the green LEDs light up on channel indicators 1 and 2 of the digital output module.  
※ **768<sub>dec</sub> = Binary 0000 0011 0000 0000**
3. You can see the input data from the tag **03 Read** on the Bar Graph window.

The screenshot displays the DAQMaster Pro software interface. The main window is titled "DAQMaster Pro - [C:\Users\101190544\Documents\AR03-C-MT\_test.daq]". The interface is divided into several panes:

- Project Tree:** Shows a hierarchy of components including "Hardware Sources" (e.g., "DAQ Source", "Bar Graph") and "My Systems" (e.g., "RTD/FOP", "Modbus Master", "AR03-C-MT").
- Bar Graph:** A window titled "Bar Graph" showing a graph with a green bar at the top, indicating a value of 768. The y-axis ranges from 0 to 100.
- Property Window:** A window titled "Property" showing the configuration for "AR03-C-MT >> 1 >> 06 Write 1". The "Value" field is set to 768.
- DAQ List:** A table listing the DAQ tags and their properties. The table has columns for "Type", "Name", "Device", "Tag Name", "Address", "Source", "Tag Name", "Type", "R/W", "Inout Mode", and "Calculation".

Type	Name	Device	Tag Name	Address	Source	Tag Name	Type	R/W	Inout Mode	Unit	Calculation
Group	0		Standard Tag (2)								
Analog	1	192.168.2.10_302_AR03-C-MT	06 Write 1	1	06 Write 1	192.168.2.10_302_L38 W...	Analog	W			
Digital	0	192.168.2.10_302_AR03-C-MT	06 Write 1	1	06 Write 1	192.168.2.10_302_L38 W...	Analog	R	Cont		
String	0		Advanced Tag (0)								
Video	0										

## 6.2. Monitor the ARIO Unit

1. Connect the CONFIG port of the ARIO coupler to the PC where the DAQMaster is installed.
2. Select the **Supported Device List » AUTONICS » ARIO Config** to add the ARIO coupler and then select the **Connect » Scan** to import the connected ARIO unit. (Comm Mode state)

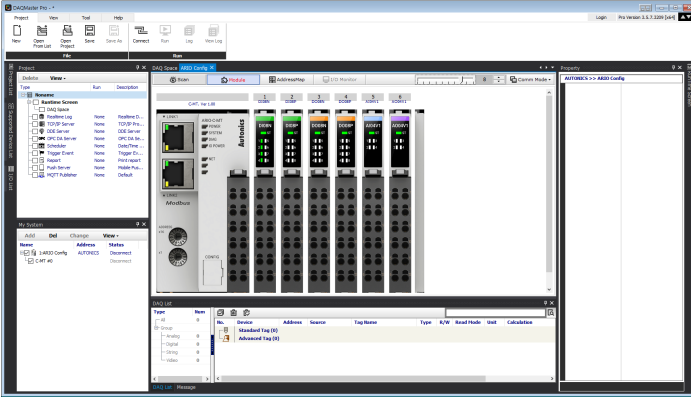

3. When Selecting the **I/O List » ARIO Config**, the tag list of the connected input/output module is displayed. Double-click the tag to be monitored to add it on the DAQ List window.

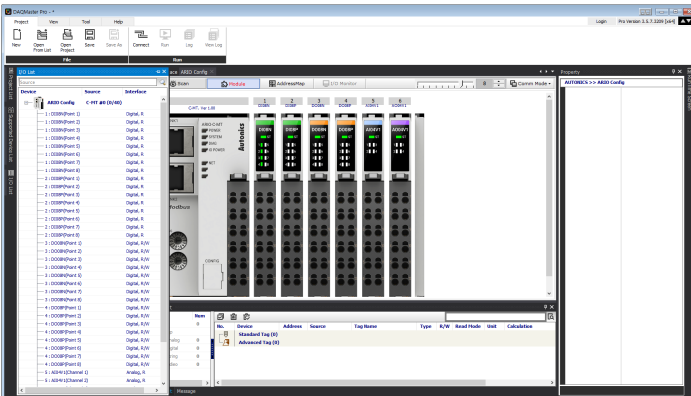



4. The tags are added on the DAQ List window as shown below.

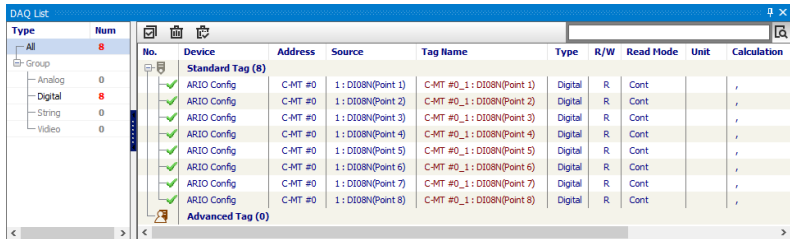

5. Double-click the **RunTime Screen » Data » (e.g.) Multi Panel** to configure the visualized monitoring screen. A multi-panel window will be created on the DAQ Space window.

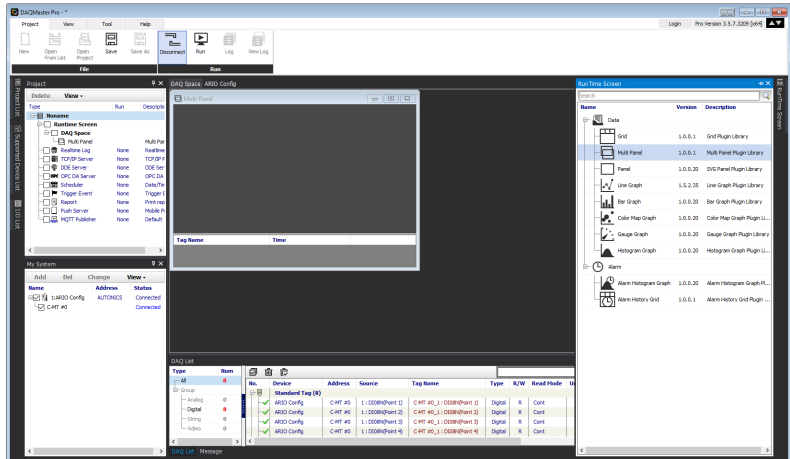

6. Drag and drop the tags added on the DAQ List window to the Multi Panel window.

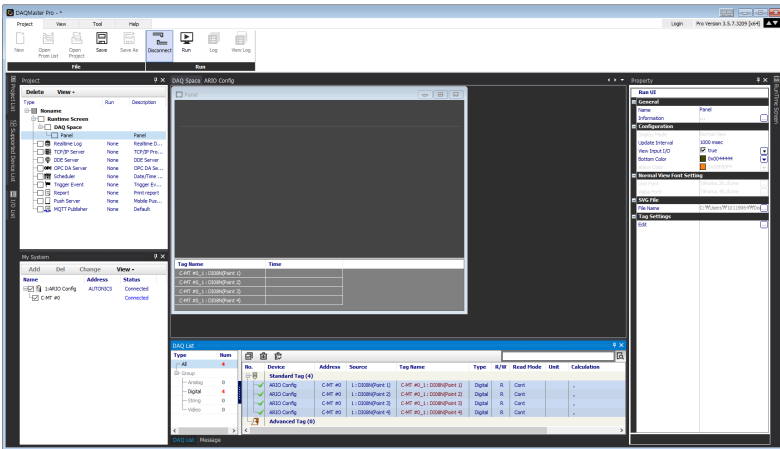

7. When selecting the **Project » Run**, you can monitor the channel status of the module.

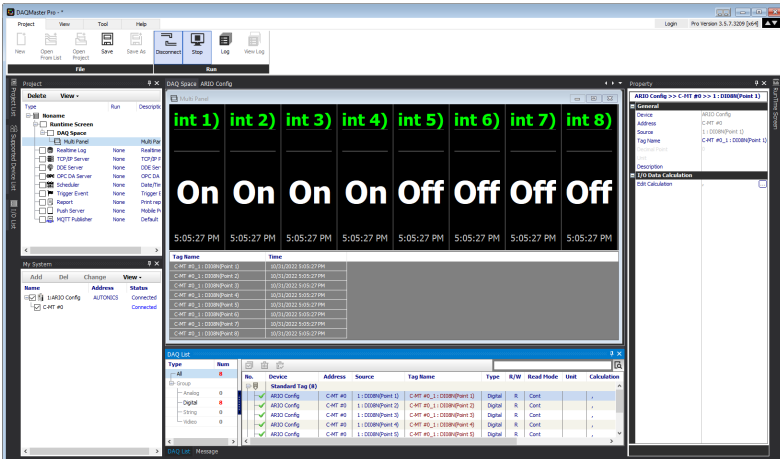

## 6.3. Update the Firmware Version

You can check the firmware (software) version of the coupler on the **Comm Mode » Property tab of the coupler » FW Version** in the DAQMaster. To update the coupler's firmware, you need to select the **Comm Mode » Property tab of the coupler » System configuration**.

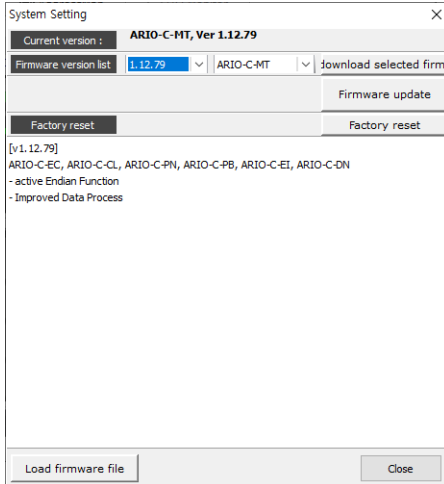

### With Internet connection

1. Select the **Firmware update** to perform the update.

### Without Internet connection

1. Download the latest firmware version of the coupler from the Autonics website.
2. Select the **Load firmware file** to import the downloaded .zip file.
3. Select the latest version of ARIO-C-MT at the **Firmware version list**.
4. Select the **Firmware update** to perform the update.



# 7. Dimensions

- For the detailed drawings, follow the Autonics website.
- Unit: mm

## Coupler

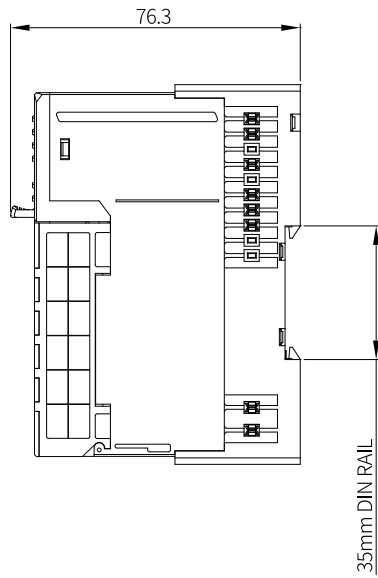
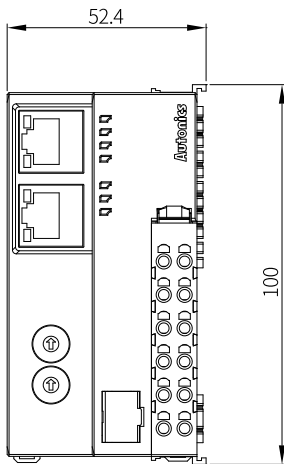
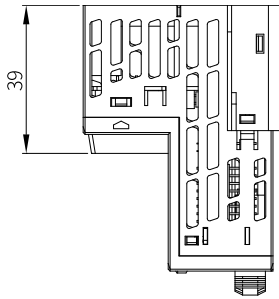

# End module

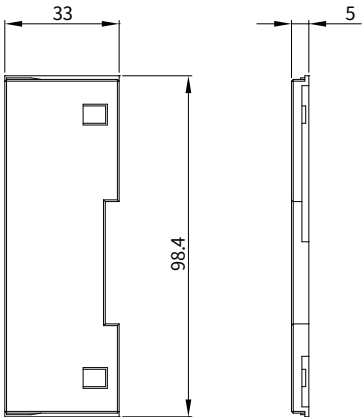

# 8. Specifications

## 8.1. Electrical/Mechanical Specifications

<b>Max. number of connectable modules</b>	≤ 64 (The length of connected modules: ≤ 768 mm)
<b>Memory size</b>	<ul style="list-style-type: none"><li>• Input: 512-byte</li><li>• Output: 512-byte</li></ul>
<b>Power supply</b>	<ul style="list-style-type: none"><li>• Unit (coupler + module): ≤ 9.6 W, ≤ 400 mA (≤ 200 mA/CH, 2-CH/COM)</li><li>• I/O: ≤ 96 W, ≤ 4,000 mA (≤ 2,000 mA/CH, 2-CH/COM)</li></ul>
<b>Supply voltage</b>	<ul style="list-style-type: none"><li>• Coupler input voltage: 24 V<sub>DC</sub></li><li>• ABUS supply voltage: 5 V<sub>DC</sub>, ≤ 960 mA</li><li>• I/O supply voltage: 24 V<sub>DC</sub></li></ul>
<b>Current consumption</b>	<ul style="list-style-type: none"><li>• The standby and run mode: 200 mA</li><li>• The maximum load: 400 mA (at coupler max. load)</li></ul>
<b>Field network connection</b>	RJ45 X 2
<b>DAQMaster connection</b>	USB 2.0 type Micro B
<b>Installation method</b>	DIN rail mounting
<b>Material</b>	Terminal: PA6, Body: MPPO, Base: PA6, POM
<b>Unit weight (packaged)</b>	≈ 165 g (≈ 265 g)

## 8.2. Environmental Conditions

<b>Insulation resistance</b>	$\geq 100 \text{ M}\Omega$ (500 $V_{DC}$ megger)
<b>Dielectric strength</b>	1000 $V_{AC}$ 50/60 Hz for 1 minute
<b>Noise immunity</b>	500 $V_{DC}$ the square wave noise (pulse width: 1 $\mu\text{s}$ ) by the noise simulator
<b>Vibration</b>	0.7 mm double amplitude at frequency of 10 to 55 Hz (for 1 minute) in each X, Y, Z direction for 1 hour
<b>Vibration (malfunction)</b>	0.5 mm double amplitude at frequency of 10 to 55 Hz (for 1 minute) in each X, Y, Z direction for 10 minutes
<b>Shock</b>	300 $\text{m/s}^2$ ( $\approx 30 \text{ G}$ ) in each X, Y, Z direction for 3 times
<b>Shock (malfunction)</b>	100 $\text{m/s}^2$ ( $\approx 10 \text{ G}$ ) in each X, Y, Z direction for 3 times
<b>Ambient temperature</b>	-10 to 55 $^{\circ}\text{C}$ , storage: -25 to 70 $^{\circ}\text{C}$ (no freezing or condensation)
<b>Ambient humidity</b>	35 to 85 %RH, storage: 35 to 85 %RH (no freezing or condensation)
<b>Protection rating</b>	IP20 (IEC standard)



# 9. Communication Interface

## 9.1. Ethernet

<b>Ethernet standard</b>	100BASE-TX
<b>Cable spec.</b>	The cable approved by the Modbus Organization or meets at least Cat 5e
<b>Transmission rate</b>	10/100 Mbps <sup>01)</sup>
<b>Cable length</b>	≤ 100 m
<b>Protocol</b>	Modbus/TCP compatible
<b>Number of nodes</b>	Depends on the network configuration
<b>Address settings</b>	Hexadecimal rotary switches, DAQMaster
<b>Topology</b>	Bus, Line, Ring, Star, Tree

01) The transmission rate is determined after performing Auto-negotiation depending on the network quality.

## 9.2. ABUS

<b>Transmission rate</b>	4 Mbps
<b>Topology</b>	Bus, Drop Line

# **Autonics**

Dimensions or specifications on this manual are subject to change and some models may be discontinued without notice.

[www.autonics.com](http://www.autonics.com)