

USER INSTRUCTION



AR407

16-CHANNEL RADIO AND WIRED DATA RECORDER



Thank you for choosing our product.

This instruction is intended to facilitate correct operation, safe use, and taking full advantage of the recorder's functionalities.

Before you start the device, please read and understand this instruction.

In the event of any additional questions, please contact our technical adviser.

CONTENTS

1. SAFETY RULES	3
2. INSTALLATION GUIDELINES	3
3. GENERAL CHARACTERISTICS OF THE MULTI-CHANNEL RECORDER	4
4. CONTENTS OF THE SET	5
5. TECHNICAL DATA	6
6. ENCLOSURE DIMENSIONS AND INSTALLATION DATA	6
7. DESCRIPTION OF TERMINAL STRIPS AND ELECTRICAL CONNECTIONS	8
8. CONNECTING TO A COMPUTER AND INSTALLATION OF USB DRIVERS	8
9. INSTALLATION OF SOFTWARE	8
<u>10. FUNCTIONS OF HARDWARE AND SCREEN BUTTONS</u>	<u>9</u>
11. DESCRIPTION OF DATA SHOWN ON THE LCD DISPLAY	11
11.1. UPPER AND LOWER STATUS BAR	11
11.2. VIEW OF A MEASUREMENT GROUP (TEXT ONLY)	12
11.3. VIEW OF A MEASUREMENT GROUP (TEXT AND BAR GRAPH)	12
11.4. VIEW OF A MEASUREMENT GROUP (TEXT AND ANALOG INDICATOR)	13
11.5. SINGLE MEASUREMENT (CHART)	13
12. SETING PARAMETERS AND OPERATIONS ON FILES (MAIN MENU)	13
12.1. MEANING OF ICONS IN MENU ITEMS	14
12.2. RECORDING SETTINGS	15
12.3. MEMORY OPTIONS AND OPERATIONS ON FILES	16
12.4. CONFIGURATION OF MEASUREMENT CHANNELS	17
<u>12.5. ADDING AND REMOVING OF MEASUREMENT SENSORS TO AND FROM A LIST..</u>	<u>18</u> 
12.6. CONFIGURATION OF ALARM OUTPUTS	19
12.6.1. EMAIL ALARM NOTIFICATIONS	21
12.7. DISPLAY SETTINGS	22
12.8. RADIO, RS485, USB, AND ETHERNET COMMUNICATION SETTINGS.....	22
12.8.1. DYNAMIC SERVER DNS (DDNS) CLIENT	24
12.9. ACCESS AND OTHER SETTINGS	24
12.10. DATE AND TIME	25

12.11. DEVICE INFORMATION	25
13. USE AND FUNCTIONS OF USB MEMORY (PENDRIVE)	25
14. VIEWING RECORDED MEASUREMENTS AND EVENTS	26
15. MESSAGE AND ERROR SIGNALING	26
16. IMPORTANT COMMENTS PERTAINING TO OPERATION. PROBLEM SOLVING.....	27 
17. RS485 COMMUNICATION INTERFACE (acc. to EIA RS-485)	28
18. MODBUS–RTU SERIAL TRANSMISSION PROTOCOL	28
19. MODBUS–TCP SERIAL TRANSMISSION PROTOCOL	29
20. MAP OF DEVICE REGISTERS FOR THE MODBUS-RTU/TCP	30
21. USER'S NOTES	32



Please pay particular attention to the text marked with this sign.

The manufacturer reserves the right to make changes to the design and the software (firmware) of the device without any deterioration of the technical parameters (some functions may not be available in older versions). Updating to the latest version of the firmware may require a repeated configuration of the device.

1. SAFETY PRINCIPLES



Before you start to use the device, become familiar with the present instructions.

- a) in order to avoid electrocution or damage to the device, its mechanical and electrical installation must be performed by qualified workers;
- b) before switching on the power supply, make sure that all cables and wires are properly connected;
- c) before making any modifications to the wire and cable connections, switch off the voltage supplied to the device;
- d) ensure proper operating conditions compliant with the technical specification of the device (chapter 5, power supply voltage, humidity, temperature, etc.); do not expose the device to direct and intense heat.

2. INSTALLATION GUIDELINES



The device is designed so as to ensure an appropriate level of immunity to most interferences that may occur in industrial and household environments. In environments of unknown level of interferences, it is recommended to implement the following measures so as to prevent potential interference with the operation of the device:

- a) do not supply the device from the same lines as high-power equipment without using appropriate power line filters;
- b) use shielded supply, sensor, and signal cables, whereby the earthing of the shield should be single-point and located as close to the device as possible;
- c) avoid running measurement (signal) cables in the direct vicinity of and parallel to power and supply cables;
- d) it is recommended to twist the signal wires in pairs or to use a finished twisted-pair cable;
- e) in the case of sensing resistors in 3-wire connections, use identical wires;
- f) avoid proximity of remotely controlled devices, electromagnetic meters, high power loads, loads with phase or group power control, and other devices that cause high impulse disturbances;
- g) ground or zero metal rails on which rail-mounted devices are installed.

Make sure to remove the protective film from the LCD display before the first use of the device.

3. GENERAL CHARACTERISTICS OF THE MULTI-CHANNEL RECORDER

- presentation and recording of data from a maximum of 16 measurement channels assigned to such Apar devices as wireless sensors of the AR43x series, one wireless temperature probe (AR182 or AR183), and any devices with an RS485 interface using the MODBUS-RTU protocol
- available wireless sensors:
 - AR431, AR432 - temperature (one measurement channel),
 - AR435, AR436, AR437 - humidity and temperature (two channels),
 - AR433, AR434 - two channels, ambient temperature and a universal input:
Pt100/Ni100/J/K/S/B/R/T/0÷20mA/ 4÷20mA/0÷10V/ 0÷60mV/0÷700Ω,
 - versions with an LCD display: AR432, AR434, AR436
- radio transmission in the ISM 868MHz band, range in an open space of up to 200 m (or 400 m) - depending on the local conditions for propagation of radio waves: the type and thickness of walls, floor slabs, etc.
- the radio range can be increased to 400 m by switching on the measurement retransmission function in the sensors (retransmission requires power supply of the sensors and no more than 3 retransmitters may be present in the network)
- 7 radio channels enabling independent operation of 7 neighboring AR407 sets with sensors
- 4 bistate alarm/control output with sound and visual signaling of the operation status and with email notification, programmable alarm characteristics and value of the output signal (in the range of 1÷100% of the impulse period) with the possibility to assign to any measurement channels
- recording of data in a standard text file located in the internal memory of the recorder (4 GB) or an USB memory in a FAT system, with possibility to edit in spreadsheet software, e.g. Microsoft Excel
- rich standard equipment with serial interfaces: USB (for work with a computer and USB memories), RS485 (MODBUS-RTU Master and Slave), and Ethernet (100base-T, MODBUS-TCP, HTTP, and SMTP protocols, etc.)
- a web server for work with any web browser (Opera, Edge, IE, Firefox, etc.); the site contains information about active measurement channels, time, status of the outputs, recording, etc., with the possibility to show diagrams using the Google Chart API service (diagrams require constant Internet access)
- the DDNS service, which enables easy access over the Internet a recorder connected to a network that has no fixed public IP address, through a friendly Internet address defined by the user; the service is available only for registered users of popular DDNS services, such as DynDNS (www.dyndns.org), No-IP (www.no-ip.com), and DNS-O-Matic (www.dnsomatic.com)
- possibility to transfer archive data and configuration data to a USB memory or using the USB port of a computer, or via Ethernet;
- a color LCD TFT graphic display 320x240 dots (QVGA), with a touch screen, brightness adjustment, and programmable background color for individual measurement channels;
- a programmable language of the menu (Polish, English), which also covers the version of the site saved on the WWW server;
- graphic and text methods of presentation of the measured values (numerical values, bar graph, counter, graph);
- grouping of measurement channels to be displayed, with automatic formatting of the screen
- a programmable F button for quick selection of one of the available functions: start/stop of recording, copying or moving archives to a USB memory, blocking of outputs, sound alarms or the touch screen and the keypad, status of the device and of internet services
- a broad selection of recording start methods (continuous, limited by date and time, periodic daily, above or below the permission threshold assigned to any measurement channel)
- internal real time clock with a battery backup power supply (up to 8 years of continuous operation)
- free software provided that enables presentation in a graphic or text form of the recorded results (ARSOFT-LOG) and configuration of parameters (ARSOFT-CFG)
- programmable types of sensors, ranges of indications, alphanumeric description of measurement channels and measurement groups, recording, alarm, display, communication, and access options, and other configuration parameters

- access to configuration parameters protected with a user password or not protected with a password
- parameter configuration methods:
 - from the film keypad and a touch screen located on the front panel of the device
 - through the USB, RS485, or Ethernet and free ARSOFT-CFG (Windows 7/8/10) software or a user's application, communication protocol MODBUS-RTU and MODBUS-TCP
 - from configuration files saved in the USB memory or on a computer disk
- available protection of measurement data from unauthorized modification (check sum)
- possibility to differentiate archives from many recorders of the similar type by assigning individual identification (ID) numbers
- intuitive use, quick configuration, clearly visible status of operation of the recording, the memory, the USB port, alarms, file and disk operations, serial transmission (USB, RS485, Ethernet, radio), menu items, etc.
- recording of data until the memory is full (at least 300 days of continuous operation with recording of 16 channels every 1 s)
- simultaneous recording of data from all active measurement channels;
- an enclosure for panel installation, leak-tightness from the front side IP30
- compliance with the R&TTE (99/5/EC) Directive
- possible update of the recorder software by the user to the latest version from a USB memory
- available sensors and accessories:
 - wireless sensors of the AR43x series (versions without an LCD display: AR431/433/435/437, versions with an LCD display: AR432/434/436)
 - a wired ambient temperature sensor AR182 (on a wire) or AR183 (boxed)
 - an antenna cable SMA with a socket and a plug, impedance 50 Ω , 2 m long
 - a USB memory (2 or 4 GB)

NOTE:



- before the start of work with the recorder, make sure to read this user's manual and properly perform the electrical and mechanical installation and configuration of the parameters; also, add new measurement channels (radio or wired) to the displayed list which, as a default, is empty (chapter 12.5)
- do not use sharp-edged objects to work with the touch screen

4. CONTENTS OF THE SET

- a recorder with an antenna for the 868MHz band
- a USB cable for connecting the device to a computer, 2 m long
- a CD with the drivers and the software (Windows 7/8/10)
- a user instruction and a warranty card

5. TECHNICAL DATA

Number of measurement channels	16 (for work with radio sensors of the AR43x series, one wired probe AR182/AR183, and any Apar devices through RS485)								
Measurement update interval	for radio sensors of the AR43x series: programmable, from 1 min. to 4 hours (5 sec. with a power supply) 1 sec. for measurements from the RS485 line, 5 sec. for a wired AR182/AR183 probe								
Radio link	ISM band		868 MHz, FSK modulation, modulation band ± 45 kHz						
	number of channels		7 (programmable in the range of 868.0 to 870.0 MHz)						
	channel operation frequency	channel	0	1	2	3	4	5	6
		MHz	869,955	869,77	869,445	869,605	868,05	868,3	868,55
	transmission parameters		output power <5 dBm, receiver sensitivity -106 dBm, rate 4.8 kbit/s						
	range (in open space)		<200 m (maximum 400 m with sensors in retransmission mode), in buildings it depends on the local conditions						
antenna (SMA-JW connection, band 850 ÷ 880 MHz)		height 97 mm, vertical polarity , impedance 50 Ω , gain 2.15 dBi, VSWR ≤ 1.5							
Wired temperature measurement probe AR182/AR183 (as one of the measurement channel, optional):									
- quantity			1, wire length 1.5 m						
- measurement range and resolution			-30 to +80 °C, measured temperature resolution 0.1 °C						
- measurement accuracy (in the range of -10 to +80 °C)			± 0.5 °C (± 0.5 to 1.7 °C in the remaining range)						
Communication interfaces (standard equipment)	- USB (a A4 type connection, accessible also from the front, programmable operation mode)	- slave mode (device)	communication with a computer, drivers for the Windows 2000/XP/Vista/7/8/10 system: exchangeable disk (mass memory, readout speed approx. 335kB/s) + virtual COM serial port (MODBUS-RTU protocol)						
		- master mode (host)	support of USB memory (pendrive) up to 4 GB, writing speed approx. 135kB/s (depending on the memory)						
	- RS485 (galvanic separation, MODBUS-RTU protocol, Master, Slave)		MASTER (readout of 16-bit registers from Apar devices), SLAVE, rate 2.4÷115.2 kbit/s, character format 8N1						
	- Ethernet (type 100base-T, socket RJ45, galvanic separation, TCP/IP protocols)		web server, MODBUS-TCP, email client (SMTP), DDNS server client, DHCP (client, server), SMTP, NetBIOS, ICMP, data transfer up to 135 kB/s (depending on the network)						
Data recording interval			programmable 1 s to 8 hours (1)						
Data storage memory (non-volatile, recording of approx. 27 million measurements from 16 channels and 4 GB memory):									
- internal (micro SDHC card, industrial, MLC)			4 GB, FAT32 file system						
- external USB memory (pendrive, A4 type socket)			FAT16, FAT32, maximum size 4 GB						
Real time clock (RTC, lithium battery CR1220)			quartz, date, time, takes leap years into account)						
Outputs (4 independent)	- relay (P1÷P4, standard)		5A / 250VAC (for resistance loads), SPST-NO						
	- SSR (transistor, type NPN OC, optional)		24V, internal resistance 850 Ω , (SSR1÷SSR4)						
Display (LCD TFT, graphic, 320x240 dots - QVGA)			3.5" (diagonal), background brightness adjustment						
Power supply:	- 230 VAC (standard)		85 ÷ 260 VAC/ 7 VA						
	- 24 VAC/DC (option)		20 ÷ 50 VAC/ 7 VA, 22 ÷ 72 VDC/ 7 W						
Rated operating conditions			0 ÷ 50 °C, <100% RH (no condensation)						
Operating environment			air and neutral gases, no dust						
Protection rating			IP30 from the front, IP20 from the side of the connections						
Weight			approx. 330 g						
Electromagnetic compatibility (EMC)			immunity: according to the PN-EN 61000-6-2 standard						
			emission: according to the PN-EN 61000-6-4 standard						

Notes: (**1**) - for a recording interval equal to 1 s, uneven recording may take place during transfer of an archive via

Ethernet and also because of an excessive number of files, their sizes, and type and manufacturer of the USB memory (pendrive) used

6. ENCLOSURE DIMENSIONS AND INSTALLATION DATA

Enclosure type	panel, Incabox XT L57	
Material	self-extinguishing NORYL 94V-0, polycarbonate	
Enclosure dimensions	96 x 96 x 79 mm	
Panel window	92 x 89 mm	
Fixing methods	grips on the side of the enclosure	
Conductor cross-sections (separable connectors)	2.5 mm ² (supply and alarm outputs), 1.5 mm ² (others)	

NOTE:

The antenna or the antenna cable must be fixed with screws manually without using tools so as not to damage the socket.

7. DESCRIPTION OF TERMINAL STRIPS AND ELECTRICAL CONNECTIONS

Location, numbering, and description of the connections on the back panel and method of connecting probes and electrical signals:

Terminal clamps (connections)	Description
ANTENNA	SMA socket to connect an antenna for the 868 MHz band
1-2-3	IN1-IN2-IN3 - input of the wired temperature probe AR182 or AR183
41÷44	serial interface RS485, MODBUS-RTU transmission protocol, MASTER (connecting Apar devices) or SLAVE (connecting to a computer, a PLC, etc.), chapters 17 and 18
45÷52	relay outputs P1, P2, P3, and P4 or SSR1, SSR2, SSR3, and SSR4
53-54	power supply input 230 VAC or 24 VAC/DC
ETHERNET	serial Ethernet interface (type 100base-T, RJ45 socket, TCP/IP protocols)
USB	serial USB interface (programmable operation mode: device or host, chapter 12.8, do not use two USB sockets at the same time)

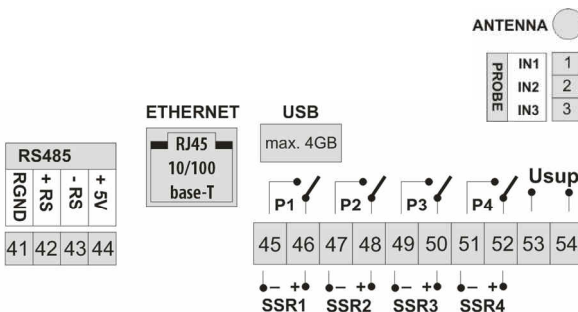

NOTE:

A USB connection is also available on the front panel.

DO NOT USE SIMULTANEOUSLY WITH THE BACK CONNECTION!

8. CONNECTING TO A COMPUTER AND INSTALLATION OF USB DRIVERS

Connecting the recorder to a USB port of a computer may be useful in order to configure the names of channels, groups, measurement units, and other parameters of the device, and to download files with recorded data. The available support software is described further in the present instructions. Before connecting the cable to the USB port of a computer, make sure that the power supply is connected to the recorder and that the **USB operation mode** parameter is set to **Available for a computer** (chapter 12.8, **Communication settings** menu). After you connect for the first time, the Windows (XP/Vista/7/8/10) system detects the recorder named "**Apar Composite Device**" and demands installation of drivers of the virtual COM serial port (MODBUS-RTU protocol, also used by the ARSOFT-CFG software). In the device manager or the new device wizard, **manually** indicate the location of the drivers (a CD-ROM, a **DRIVERS** folder, or drivers downloaded from the www.apar.pl website).

In Windows 7/10 systems, one can use automatic downloading of the driver software from the Windows Update website. In the Windows 7 system, from the **Device Manager** level, manual installation is performed in the following manner:

1. Right-click the item "**Apar Composite Device**" and select "**Update the driver software**", and then "**Browse my computer to find the driver software**".
2. Use the "**Browse...**" button to indicate a location on the disk (the **DRIVERS** folder) where the drivers are saved, and then click "**Continue**".
3. The virtual COM port "**USB Serial Port**" is installed; press "**Close**".
4. Additionally, in the "**Disc drives**" branch, the system detects and installs the "**Microchip Mass Storage USB Device**".

After the installation is completed, the recorder is listed in the system as an exchangeable 4 GB disk with the label **AR407** and a virtual COMx serial port (x - port number: 1, 2, etc.). The serial port uses the MODBUS-RTU protocol. In the internal memory two configuration text files are shown: **AR407.cfg** and **AR407.txt** (chapter 12).

Communication with the device can also be established using the Ethernet and the RS485 interfaces, which are a part of the recorder's standard equipment and do not require installation of additional drives. However, if an RS485 converter for USB is used in the computer, it is necessary to install the serial port drivers provided by the manufacturer.



- do not disconnect the device from the computer before completion of installation of the drivers
- connection of the recorder to a USB port of a computer stops recording until the cable is disconnected and blocks the performance of file operations available from the menu level and transmission of files with measurement data via Ethernet from the ARSOFT-LOG level

9. INSTALLATION OF SOFTWARE

In the "**SOFTWARE**" folder of the CD-ROM that is provided with the device there is a free software installation set for the recorder. The installation set comprises the following applications (for Windows 2000/XP/Vista/7/8/10):

Name	Software description
ARSOFT-CFG (on-line configuration)	<ul style="list-style-type: none">- display of current measurement data, as well as the date and the time,- configuration of the real time clock (RTC) and other parameters, such as types of measurement sensors, names of measurement channels, units, and groups, ranges of indications, recording, alarm, display, communication, and access options etc. (chapter 12),- creation on the disk of configuration files containing the current parameter settings for the purpose of repeated use (backup copy or multiplication of the configuration),- the program requires communication with the recorder via the USB, RS485 or Ethernet port
ARSOFT-LOG	graphic or text presentation of recorded results with the possibility to print, input data is taken from a csv text file created in the recorder in the internal memory or the USB memory (chapter 14), data can also be taken via Ethernet

The latest versions of the aforementioned software are also available at the website (www.apar.pl, Download → Software section). The detailed descriptions of the aforementioned applications can be found in the installation folders.

10. FUNCTIONS OF HARDWARE AND SCREEN BUTTONS

Fig. 10. Description of the front panel

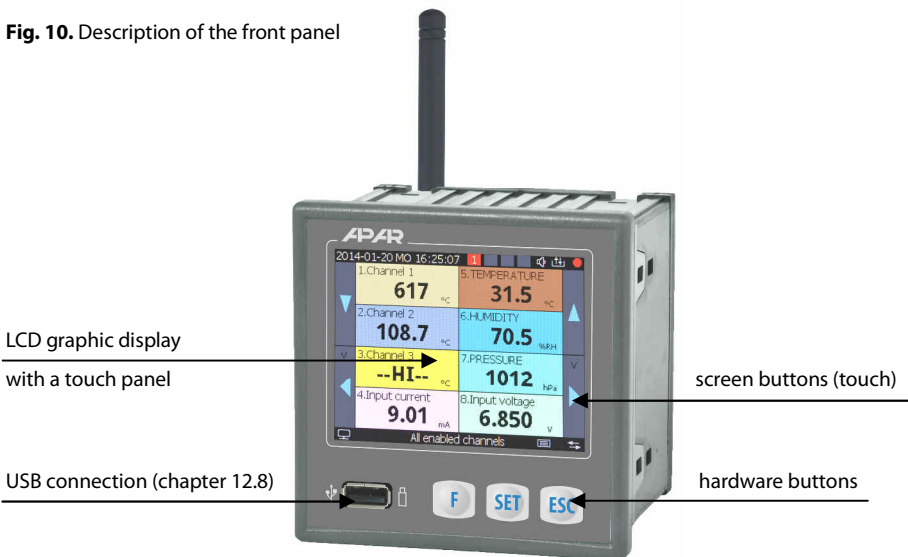



NOTE:

Do not use sharp-edged objects to work with the screen buttons and other screen objects

a) button functions in the measurement display mode (chapter 11)

Button	Description [and marking in the contents of the instruction]
	[SET], hardware button: - input in the parameter configuration and file operations menu (chapter 12). If the Password protection in the Access and other settings menu is switched on, then the password must be entered, chapter 12.9 - closes the message window appearing on the screen (chapter 15)
	[UP] or [DOWN], screen buttons: change of the displayed measurement group or a single measurement channel in the DIAGRAM presentation mode
	[LEFT] or [RIGHT], screen buttons: change of the measurement data presentation mode (TEXT, BAR GRAPH, ANALOG INDICATOR, DIAGRAM, chapter 11)
	[F], hardware button: activation of a function programmed with the F button function parameter (chapter 12.9), active only in the measurement presentation mode, sub-item c
	[ESC], hardware button: closing the message window appearing on the screen (chapter 15)
	[F] and [ESC] (simultaneously): calling the Device status screen (hardware information, operation and Ethernet services parameters, current record number in the csv archive file, etc.); the function is available also from the level of the [F] button (sub-item c and chapter 12.9)

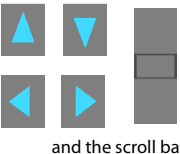
b) functions of the buttons in the parameter configuration and file operations mode (**Main Menu**, chapter 12)

Button	Description
	<ul style="list-style-type: none"> - selects the marked item in the menu (entering a lower menu level or edition of a parameter); the action is also available from the touch screen level - approves of the edited parameter value (saving in the non-volatile internal memory takes place after leaving the <i>Main Menu</i> or disconnecting the USB from the computer) - closes the message window appearing on the screen (chapter 15)
 <p>and the scroll bar</p>	<p>[UP] or [DOWN] and the screen scroll bar:</p> <ul style="list-style-type: none"> - moves to the next or previous item in the menu - changes the value of the edited parameter (also [LEFT] or [RIGHT])
	<ul style="list-style-type: none"> - returns to the previous menu (higher level) - cancels the changes to the edited parameter - exits the <i>Main Menu</i> and returns to the measurement presentation mode - closes the message window appearing on the screen (chapter 15)

c) meaning of the function button [F] (active only in the measurement presentation mode)

Button	Description (depending on the value of the <i>F button function</i> parameter in the <i>Access and other settings</i> menu, chapter 12.9)	Status signaling/icon
	Device status - device status screen (factory setting, function available also by simultaneously pressing buttons [F] and [ESC], described in item a above)	screen
	Stop/Start of recording - change of the <i>Recording type</i> parameter to Off or Continuous (chapter 12.2), after the power supply is switched on, the recording is always on (continuous)	● or none
	Copy the archives to the USB memory (operation available also in the <i>Memory and files options</i> menu, chapter 12.3)	messages
	Move the archives to the USB memory - the files in the recorder are deleted after they have been copied	messages
	Disable/Enable sound alarm - change of the <i>Alarm sound signal</i> parameter to Disabled or Enabled (chapter 12.6, <i>Outputs (alarm) configuration</i> menu), after the power supply has been switched on, the sound signaling of all alarms is always on	🔊 or none
	Block/Unblock all alarms - after the power supply has been switched on, all alarm outputs are always in operation in accordance with the programmed characteristics (chapter 12.6)	🔒 or none
	Touch panel lock - touch screen and keypad lock (except for [F])	🔒 or none

11. DESCRIPTION OF DATA PRESENTATION ON THE LCD DISPLAY

The recorder enables presentation of the measurement data in various modes in accordance with the following diagram:

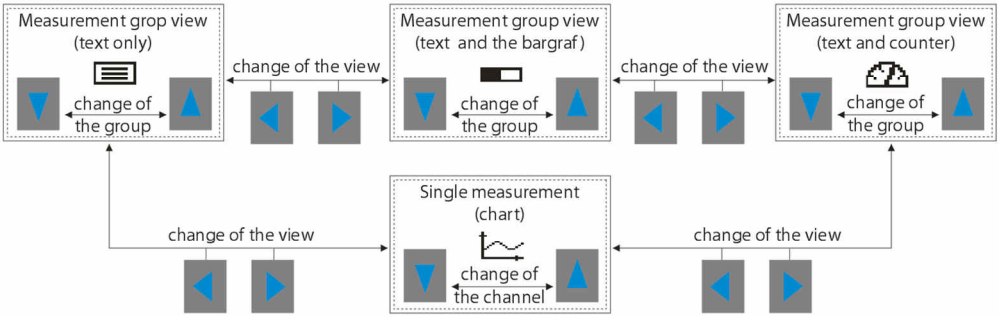

Fig. 11. A block diagram of the available measurement data presentation modes (the detailed descriptions are provided in successive chapters)

As a default, the device is delivered with an empty list of measurement channels. In order to present the data, new sensors/devices (radio and wired, chapter 12.5) must be added to the list. If the number of channels in a group exceeds the maximum value that enables presentation of all the graphic element of a given view on the screen, the view is automatically switched to the text mode.

11.1. UPPER AND LOWER STATUS BAR

The status bars can be seen in the upper and lower part of the display only in the measurement presentation modes.

The meaning of the individual graphic elements is described below.

a) lower status bar



Fig. 11.1.2. Lower status bar

Object	Description [and marking in the contents of the instructions]			
6		no USB connection with the computer	the USB port is accessible for the computer (device)	signaling of the operation mode and the status of the USB port (chapter 12.8, Table 12.8, USB operation mode parameter)
		the USB port is connected to the computer		
		no USB memory, do not connect to the computer!	USB memory support (host), chapter 13	
		USB memory (pendrive) was detected		
7	measurement group name (up to 16 characters per group, taken from the AR407.txt file, chapters 12.4 and 12.5)			
8		view of a measurement group (text only)	signaling of measurement data presentation mode (type of view)	
		view of a measurement group (text and a bar graph)		
		view of a measurement group (text and an analog indicator)		
	none	single measurement (chart)		
9	[Tx/Rx] - signaling of presence of serial transmission (via the RS485, a USB port or the Ethernet)			
10	signaling of the touch screen and keypad lock (one of the [F] button functions), chapter 12.9			

b) upper status bar



Fig. 11.1.1. Upper status bar

Object	Description [and marking in the contents of the instructions]
1	date (yyyy-mm-dd), day of the week and time (hh:mm:ss) on the real time clock (RTC, chapter 12.10)
2	status of alarm outputs, from the 1st to the 4th (chapter 12.6, Outputs (alarm) configuration menu) gray - the output is switched off (the alarm is inactive); red (with the numbers of the input channels that activate the alarm) - the output is switched on
3	parameter Alarm sound signal is set to the Enabled value (chapter 12.6)
	all the alarm outputs blocked with the programmable [F] button (chapters 10 and 12.9)
4	[R/W] - signaling of writing to or reading from the internal memory or the USB memory
5	signaling of ongoing recording in the internal memory or the USB memory ()

11.2. VIEW OF A MEASUREMENT GROUP (TEXT ONLY)

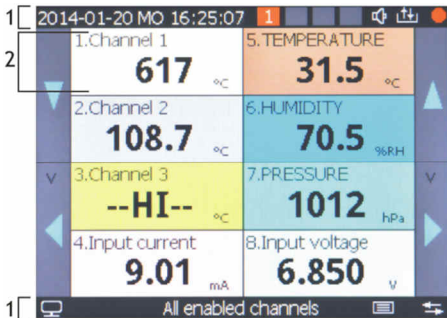

Object	Description
1	status bars (chapter 11.1)
2	measurement panel: number, name (up to 16 characters) and unit (up to 4 characters) of the measurement channel (name and unit taken from the AR407.txt file, chapters 12.4 and 12.5), measured value with signaling of exceeded measurement range (chapters 12.4, 12.5 and 15)

Fig. 11.2. Appearance of a measurement group screen in the TEXT ONLY mode (presentation max. 16 channels is possible)

11.3. VIEW OF A MEASUREMENT GROUP (TEXT AND A BAR GRAPH)

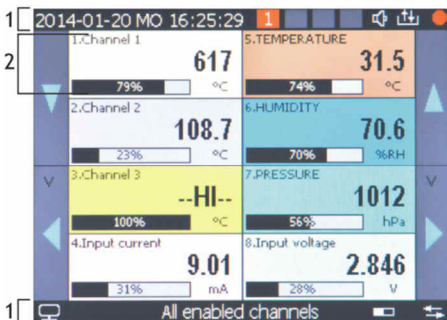

Object	Description
1	status bars (chapter 11.1)
2	measurement panel: number, name, measured value, and unit of the measurement channel (chapter 11.2), graphic presentation of the measurement (bar graph) works in the range set by the parameters Bottom of indication range for graphics and Top of indication range for graphics (chapters 12.4 and 12.5)

Fig. 11.3. Appearance of a measurement group screen in the TEXT AND BAR GRAPH mode (presentation max. 8 channels is possible)

11.4. VIEW OF A MEASUREMENT GROUP (ANALOG INDICATOR, COUNTER)

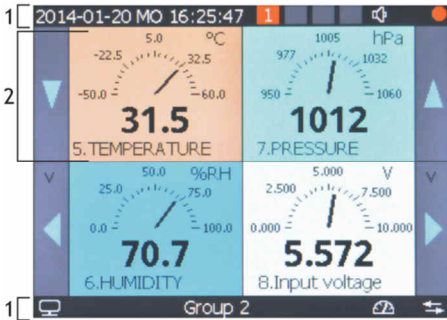

Object	Description
1	status bars (chapter 11.1)
2	measurement panel: number, name, measured value, and unit of the measurement channel (chapter 11.2), graphic presentation of the measurement (analog indicator) works in the range set by the parameters Bottom... and Top of indication range for graphics (chapt. 12.4 and 12.5)

Fig. 11.4. Appearance of a measurement group screen in the ANALOG INDICATOR mode (presentation max. 6 channels is possible)

11.5. SINGLE MEASUREMENT (CHART)

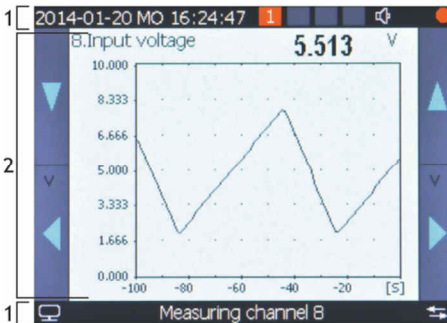

Object	Description
1	status bars (chapter 11.1)
2	measurement panel: number, name, measured value, and unit of the measurement channel (chapt.11.2), graphic presentation of the measurement (diagram) works in the range set by the parameters Bottom of indication range for graphics , Top of indication range for graphics (chapt. 12.4 and 12.5), and Chart time range (chapt.12.8)

Fig. 11.5. Appearance of a single measurement screen in the CHART mode (possibility to present one channel)

12. SETTING PARAMETERS AND OPERATIONS ON FILES (MAIN MENU)

All the configuration parameters, names of channels and groups, and measurement units of the recorder are stored in the non-volatile internal memory in two text files: *AR407.cfg* (numerical parameters) and *AR407.txt* (names, units, groups, etc.) - changes can be implemented only using a computer in the ARSOFT-CFG software via the USB port or the Ethernet, as well as in any text editor, e.g. Windows Notebook).

When the device is switched on for the first time, the measurement channels list is empty and new sensors must be added (chapter 12.5).

As a standard, the parameter configuration can be performed using one of the following three methods (**do not use them at the same time**):

1. From the film keypad and a touch screen located on the front panel of the device:

- from the mode where the input measurements are displayed in the **Main Menu** ([SET] button). If **Password Protection** in **Access and other settings** is on, enter the password - the default value is **1111**; see chapter 12.9

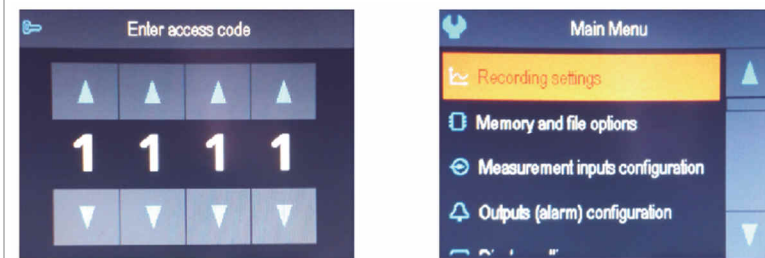

Fig. 12. Appearance of the password screen and the **Main Menu**

- use the **[UP]** or **[DOWN]** button, or the scroll bar to select an appropriate sub-menu or parameter to be changed/viewed
- use the **[SET]** button or touch the selected item in the menu (also in order to edit the parameter)
- use the **[UP]**, **[DOWN]**, **[LEFT]**, or **[RIGHT]** button, or the scroll bar to change the value of the edited parameter
- approve the changed value of the parameter by pressing the **[SET]** button or cancel it by pressing the **[ESC]** button

2. Use the USB or RS485 port, or the Ethernet and the ARSOFT-CFG software (on-line configuration) to:

- connect the recorder to a computer port and start and configure the ARSOFT-CFG application
- after the connection has been established, the current measured values and the internal time and date of the recorder are displayed; the **[Tx/Rx]** icon indicates the presence of transmission (lower status bar, chapter 11.1)
- setting and viewing of the device parameters is possible in the parameter configuration window
- new parameter values must be approved with the **Approve changes** button
- the software enables synchronization of the time and the date with the computer
- the current configuration can be saved in a file on the disk or set using values read from a file
- **the recorder updates** the configuration files and **the displayed names after it is disconnected from the computer's USB port**
- online configuration via the USB port is possible only when the **USB operation mode** parameter is set as **Available for computer (device)**, chapter 12.8.



- before disconnecting the device from a computer, press the **Disconnect device** button
- in the event of no response:
 - in the **Program options** check the configuration of the port and the **MODBUS Address of the device** (in the case of the RS485)
 - make sure that the serial port drivers have been installed correctly (chapter 8)
 - disconnect for a few seconds and then reconnect the recorder to the USB port
 - restart the computer

3. From the configuration file created in the ARSOFT-CFG software or copied from another recorder of the same type to copy the configuration, off-line configuration:

- in ARSOFT-CFG set the required parameters (except for the **RTC** and the identification number **ID**)
- a current configuration can also be prepared by modifying the values read from the existing files
- save the created configuration in an *AR407.cfg* or *AR407.txt* file and save it in a USB memory
- in the **Memory and file options** of the recorder, import the configuration from the USB memory, chapter 12.3
- after the configuration has been completed, the memory can be disconnected from the USB socket

As an alternative to the configuration methods described above, the user can prepare his own application using the available serial interfaces and the MODBUS-RTU or MODBUS-TCP communication protocol.

The default (factory) configuration can be restored manually (chapter 12.3), online or offline (see the description above).





Do not shut down the power supply during the configuration performed using the keypad or on-line (via the computer's USB port) because the changed parameter values are stored in the internal memory after the user exits the **Main Menu** (by pressing the **[ESC] button**) or disconnects the device from the USB socket.

12.1. MEANING OF ICONS IN THE MENU ITEMS

In order to improve the ease of use and configuration of the device, additional graphic descriptive elements were added to the menu in the form of icons (pictograms).







The shared meaning of some icons described the type of menu item is the following:

Icon	Type of menu item (parameter)
	parameter that can be modified using the buttons and the touch screen, saved in the internal memory
	informative item, not modified directly using the buttons and the touch screen
	file or disk action (operation) (chapter 12.3)

12.2. RECORDING SETTINGS

Data is archived in a text file with a csv extension in the internal memory or the USB memory; a detailed description of the storage format is given in chapter 14. Data is recorded until the memory is full (at least 300 days of continuous operation with recording from 16 channels every 1 s) and then the recording is stopped and the following message is displayed repeatedly "Memory full. Recording rejected" (chapter 15). The recording must then be stopped (the **Recording type** must be set to the **Off** value, Table 12.2), the archive files must be copied for further analysis, and space must be freed up in the memory for future recordings. The selection of the memory for recording and the copying and deleting of existing csv files are accessible in the **Main Menu -> Memory and file options**; a detailed description of operations performed on files is given in chapter 12.3. The data recording interval must be adjusted according to the needs of a specific application.

Table 12.2. Configuration parameters in the **Recording settings** menu









Parameter 	Range of variability of the parameter and description		Default settings
Data recording interval	1 s to 8 h (note 1 in the technical data, chapter 5) (1)		1 minute
Recording type (2) (chapter 14)	 Off	recording switched off permanently	Disabled
	 Continuous	recording switched on permanently	
	 Limited by date and time	recording is active within the range of the Date and the Time defined by the parameters Start and End of time limit	
	 Periodic daily (hourly)	recording is active within the range of the Time defined by the parameters Start and End of time limit	
	 Above the permission threshold	recording is active when the measured value of the channel defined by the Selection of permission channel is larger than the value of the Permission threshold value parameter	
	 Below the permission threshold	recording is active when the measured value of the channel defined by the Selection of permission channel is smaller than the value of the Permission threshold value parameter	
Start of time limit	Date: 01.06.2008 ÷ 31.12.2099, Time: 00:00:00 ÷ 23:59:59, the parameter is active when the Recording type = Limited by date and time or Periodic daily		2013.06.01 00:00:00
End of time limit	Date: 01.06.2008 ÷ 31.12.2099, Time: 00:00:00 ÷ 23:59:59, the parameter is active when the Recording type = Limited by date and time or Periodic daily		2013.06.01 00:00:00
Selection of permission channel	Measurement channel 1 ÷ Measurement channel 16 or All channels the parameter is active when Recording type = Above or Below the permission threshold		Measurement channel 1
Permission threshold value	-199.9 ÷ 1999.9°C, -9999 ÷ 19999 (3), the parameter is active when Recording type = Above or Below the permission threshold		50.0 °C

Notes: (1) - the recording interval is counted from the moment the device is disconnected from the USB port
(2) - the device does not record data in a file when it is connected to the computer's USB port
(3) - applies to analog inputs (mA, V, mV, Ω) in the AR433/434 sensor

12.3. MEMORY OPTIONS AND OPERATIONS ON FILES

The recorder enables performing standard operations on files and disks from the menu level. The list of possible actions is given in the table below (12.3). These functions are blocked after the device is connected to a computer's USB port, which is due to the principle service of exchangeable disks (mass memories) by the operating system (Windows).

Table 12.3. Configuration parameters and file operations in the **Memory and file options** menu

File parameter or action (operation)	Description of the available file operations and parameters		Default settings
 Memory status	Cancel		Fig. 12.3. Appearance of the internal memory status screen (recording interval 1 s for 8 channels). The field " Storage capacity: " takes into account the Data recording interval (chapter 12.2) and the number of active measurement inputs (12.4, 12.5)
	Internal memory		
	USB memory		
 Copy archives to the USB memory (1)	Cancel	return to the previous menu (higher level)	
	Copy	copy the archive (files with the csv extension) from the internal memory to the USB	
 Delete all archives	Cancel	return to the previous menu (higher level)	
	Internal memory	delete the archive (files with the csv extension) in the internal memory	
	USB memory	delete the archive (files with the csv extension) in the USB memory	
 Archive storage memory (2)	Internal only	archive files are created only in the internal memory	<i>Internal only</i>
	Auto select	archive files are created in the USB memory (when detected) or the internal memory (when there is no USB memory)	
 Archive identification number (ID)	0 ÷ 999	an individual device number entered into the initial records in the archive file (csv) in order to distinguish archives from different recorders of the similar type; it should be set before the recording starts	0
 Copy configuration to the USB memory	Cancel	return to the previous menu (higher level)	
	Copy	copy the current settings (<i>AR407.cfg</i> and <i>AR407.txt</i>) into the USB memory	
 Configure from the USB memory	Cancel	return to the previous menu (higher level)	
	Parameters	copy the configuration parameters (<i>AR407.cfg</i>) from the USB memory	
	Names	copy the names of channels, groups, and units (<i>AR407.txt</i>) from the USB memory	
	All	copy all settings (<i>AR407.cfg</i> and <i>AR407.txt</i>) from the USB memory	
 Reset to default settings	Cancel	return to the previous menu (higher level)	
	Parameters	set the default configuration parameters (<i>AR407.cfg</i>) in the recorder	
	Names	set the default names and units (<i>AR407.txt</i>) in the recorder	
	All	set the default parameters and names (<i>AR407.cfg</i> and <i>AR407.txt</i>)	
	Delete the list of radio sensors	clear the list of radio measurement channels (chapter 12.5)	
Format the memory (3)	Cancel	return to the previous menu (higher level)	
	Internal memory	format the internal memory in the FAT32 system, preserving the current settings (parameters in the file <i>AR407.cfg</i> and names in the <i>AR407.txt</i> file)	

- Notes:** (1) - in the case of a 90 MB file, the copying time is equal to approx. 11 min. (approx. 135 kB/s, also depending on the type of memory)
- (2) - **Archive storage memory = Internal only** prevents unintentional creation of an archive in the USB memory installed in the port by accident, in order to perform file operations, or by unauthorized personnel
- (3) – formatting deletes all data from the memory (with the exception of configuration files); this operation is recommended in the event of problems with accessing data









- during file operations or formatting of memory, **do not shut down the power supply** and **do not take out the USB memory**, as this may cause a loss of recorded data or the current configuration (parameters and names)
- until the file operations or memory formatting is completed, recording is stopped and transmission of files with measurement data over the Ethernet from the ARSOFT-LOG level is blocked

12.4. CONFIGURATION OF MEASUREMENT CHANNELS

The recorder can present and record data from a maximum of 16 measurement channels from wireless sensors of the AR43x, series, from one wired temperature probe (AR182 and AR183), and through the RS485 interface from any Apar devices using the MODBUS-RTU protocol.

As a default, the device is delivered with an empty list of measurement channels. In order to present the data, new sensors/devices (radio and wired, chapter 12.5) must be added to the list.

Table 12.4. Configuration parameters in the **Measurement channel** configuration menu for the selected channel (1÷16)

Parameter 	Range of variability of the parameter and description		Default settings
 Name, unit and group	edition of the name of the channel and the group (max. length 16 characters) and of the measurement unit (4 characters) is possible on a computer (via the USB port or the Ethernet and the ARSOFT-CFG software or by copying the configuration - chapter 12.3). The format of a single section in the AR407.txt file is the following: [Chan1] Name= Channel 1 , Unit=°C, [Group1] Name= Group 1		Measurement of channel <i>i</i> (for $i=1÷16$), °C, Group <i>j</i> (for $j=1÷8$)
Assigned sensor type	 None	channel switched off (absent in the presentation and the recording)	Radio
	 Radio	wireless sensor of the AR43x series	
	 RS485	Apar device with the RS485 interface (MODBUS-RTU protocol)	
	 Probe	temperature probe AR182 or AR183	
Address of assigned sensor (ID)	0 ÷ 16	identification number of the sensor/device assigned to the selected channel (address of the device with the RS485 and the MODBUS-RTU protocol or the ID of the radio sensor, for ID=16= None)	None (16)
Register address to read for RS485	0 ÷ 9999	address of the register for readout from the RS485 register and the MODBUS-RTU protocol (conforming to the device registers map)	0
Decimal dot position for the readout from the RS485 sensor (1)	None	0, no point	Position 1 (0.0/0.1°C)
	Position 1	0.0	
	Position 2	0.00	
	Position 3	0.000	
Bottom of indication range for graphics	-199.9 ÷ 1999.9°C or -9999 ÷ 19999 units (2) – the lower value of the range of variability for graphic elements (bar graph, counter, diagram)		0.0 °C
Top of indication range for graphics	-199.9 ÷ 1999.9°C or -9999 ÷ 19999 units (2) – the upper value of the range of variability for graphic elements (bar graph, counter, diagram)		100.0 °C

Assignment of alarm outputs	combinations of Alarm outputs 1 ÷ 4 or None , selection of alarm outputs activated by the measurement of the current channel, chapter 12.6	<i>Alarm out. i</i> (for $i=1-4$)
Assignment of the measurement group	channel Belongs to all groups or only to one group in the range of 1 ÷ 8 , channel grouping is used in the measurement presentation modes	<i>Group i</i> (for $i=1-8$)
Background color	selection of the background color in the measurement presentation modes, 23 colors are available	<i>color</i>

Notes: (1) - for radio sensors, the resolution of indications (point position) is taken remotely (by radio)
(2) – applies to analog inputs (mA, V, mV, Ω) in the AR433/434 sensor

12.5. ADDING AND REMOVING OF MEASUREMENT SENSORS TO AND FROM A LIST

As a default, the device is delivered with an empty list of measurement channels. For the purpose of presentation of data, new channels must be added to the list that are assigned to the radio sensor of the AR43x series and/or Apar devices connected to the RS485 line and/or the AR182/AR183 temperature probe. Selection of the serviced interface (radio, RS485, or probe) for each of the channels is set with parameter **Assigned sensor type** (in the **Measurement channels** configuration menu; a detailed description can be found in chapter 12.4).

In a correctly configured system, all measurement channels of the same type (radio sensors or RS485 devices) should have their own unique identification numbers (ID or MODBUS-RTU address, set with the **Address of assigned sensor ID** parameter, chapter 12.4).

When the **Assigned sensor type = RS485 (MODBUS-RTU)**, it is also necessary to configure the **Decimal dot position** and the **Register address to read for RS485** (e.g. 16-bit measurement with a character, according to the map of MODBUS-RTU registers of the connected device that is available in its user's instruction) and in the **Communication settings** (chapter 12.8), set the **RS485 operation mode** parameters to **Master** and the **Baud rate for RS485** to one that is compatible with the device.

If the **Assigned sensor type = Radio (AR43x)**, then the measurement channel adding or deleting procedure follows the description below.

Before the wireless sensors adding procedure is started, make sure that all devices of the configured system work on the same radio channel number that is different than that of the neighboring radio networks that are in the range (as a default - channel 6; the larger the number, the better; see chapter 12.8).

1. There are two ways to add radio sensors to the list (indexing):
 - a) automatic (initiated with the **ADD/REF/OFF** button in the AR43x sensor)

NOTE:



Radio sensors **must** be indexed individually!

The start of the procedure to obtain an index (**ID**) is indicated in the sensor by a single momentary illumination of the **Status** and **RX/TX** diodes, which takes place after the **ADD/REF/OFF** button is pressed.

The end of the procedure takes place when the **"New radio sensor was registered"** or **"No available channels. Provide unused ones."** message is displayed on the AR407 display.

After the message is closed with the **[SET]** or **[ESC]** button, one can start indexing another sensor, unless the list is full (a maximum of 16 channels). In the event of a failure, the procedure must be repeated. **The maximum duration of the procedure is approximately 35 seconds.**

In the case of indexed 2-channel sensors (AR433/434/435/436/437), it is possible to delete the second channel from the list of the AR407 recorder (parameter **Address of assigned sensor (ID) = None=16** in the **Measurement channel** configuration menu, chapter 12.4), e.g. in order to switch this channel off or make it available to another sensor.

NOTE:



At the same time, if the procedure is started on several sensors, they are assigned the same **ID** address (number) and, as a result, they are assigned to the same measurement channels in AR407 (the data will be

mixed). If this takes place, the sensors must be switched off (by setting **ID=16**) and deleted from the recorder list (see item 2 below), and then the indexing process should be restarted.

- b) programmable (using the ARSOFT-CFG software and, optionally, the keypad of the AR407 recorder)
Using the ARSOFT-CFG software, one must assign different indices (the **ID** parameter to the measurement sensors and then the same values should be used in the target measurement channels of the AR407 recorder in the **Address of assigned sensor (ID)** parameter (in the **Measurement channels** configuration menu, chapter 12.4).

In order to present two measurement channels in the case of two-channel sensors (AR433/434/435/436/437), the same **ID** number should be assigned to two measurement channels of the AR407 recorder.



Each radio sensor working in the system **must** have a different identification number (the **ID** parameter)!

- 2. In order to delete radio sensors from the measurement list** of the AR407 recorder, one must only set, for the selected channel, the **Address of assigned sensor (ID)** or **Assigned sensor type** parameter to the value **None (Measurement channels** configuration menu, chapter 12.4). In order to quickly delete the entire measurement list (all assigned sensors), one can use the **Delete list of radio sensors** function available in the following location: **Main Menu -> Memory and file option -> Reset to default settings**, chapter 12.3.
Moreover, sensors that are not in use should be switched off in order to save the battery and to eliminate their influence on the system in operation. To do so, the **ID** parameter of the sensor must be set to the value of **16**; this can be done in two ways:

- a) with the power supply of the AR407 recorder **switched off** or with the recorder outside of the radio range, press the **ADD/REF/OFF** button in the sensor for about 10 sec.; the sensor will be switched off after no more than 35 sec.; this can be done simultaneously with several sensors
- b) using the ARSOFT-CFG software and the connected USB cable



If radio sensors are not in use, it is recommended to completely switch off the radio scanning in the AR407 by setting in the unused measurement channels the **Assigned sensor type** to the **None (channel switched off)** value.

In order to test the range in the eventual place of installation, the functions provided by the **ADD/REF/OFF** button in the AR43x sensor can be used (using the methods described in the user's manual of the sensor, chapter 5.1).

For optimum performance of the system and in the event of communication problems (between the sensors and the base station of the AR407), **read the operating notes in chapter 16.**



12.6. CONFIGURATION OF ALARM OUTPUTS

The **Outputs (alarms) configuration** menu comprises four identical sets of parameters grouped according to the output number described in the Table 12.6.1 and other items listed in Table 12.6.2.

For alarm states, it is possible to program the value of the output signal (the filling coefficient with the impulse period set), which can be useful for signaling purposes or for adjustment of power.

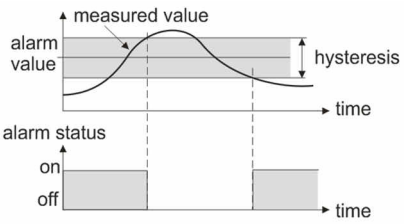
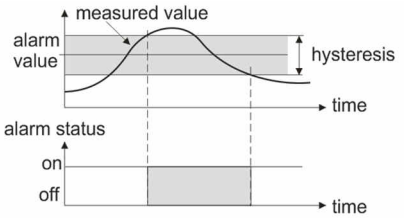
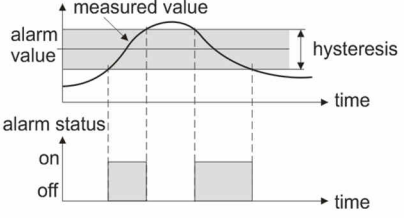
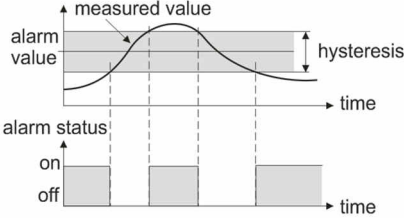

Table 12.6.1. Configuration parameters in the **Outputs (alarms) configuration** menu for the selected alarm output

Parameter	Range of variability of the parameter and description	Default settings
 Assigned inputs	numbers of the active measurement channels assigned to the selected alarm; the assignment is made in the Measurement channel configuration menu (chapter 12.4, parameter Assignment of alarm outputs)	1 ÷ 16 or None

 Alarm type	Disabled	constantly switched off alarm output	
	Inverted /heating	 <p>Fig. 12.6.1. Characteristics of a <i>Heating</i> type alarm</p>	
	Direct/cooling	 <p>Fig. 12.6.2. Characteristics of a <i>Cooling</i> type alarm</p>	
	Inside of the band	 <p>Fig. 12.6.3. Characteristics of an <i>In the band</i> alarm</p>	<i>Disabled</i>
	Outside of the band	 <p>Fig. 12.6.4. Characteristics of an <i>Outside of the band</i> alarm</p>	
 Alarm value (1)	-199.9 ÷ 1999.9°C or -9999 ÷ 19999 units (2)		50.0 °C
 Alarm hysteresis (1)	0 ÷ 500.0°C or 0 ÷ 5000 units (2)		0.0 °C
Output signal value(duty cycle)	1 ÷ 100 % 1% step	output control value for the activated alarm (filling coefficient with the Output signal pulse period set, if the value is 100%, the output is constantly switched on)	100%
Output signal pulse period	1 ÷ 3600sec.	output impulse period for the activated alarm with the Output signal value (filling) preset	4 sec.

Notes: (1) - for radio sensors, the resolution of indications (point position) is taken remotely (by radio)
(2) - applies to analog inputs (mA, V, mV, Ω) in the AR433/434 sensor

Table 12.6.2. Other configuration parameters in the **Output (alarms) configuration** menu

Parameter	Range of variability of the parameter		Default settings
 Alarm sound signal	Disabled	controlling the operation of the integrated acoustic transducer (buzzer) which enables signaling of activation of any of the alarms. This parameter can also be controlled from the level of the [F] function button, chapter 10, item c.	<i>Disabled</i>
	Enabled		
 Email alarm notifications	Disabled	a service that enables signalization of activation of any alarm via an email message; the description can be found in chapter 12.6.1	<i>Disabled</i>
	Enabled		
 Email settings and status	The configuration data of the email service and the number of email messages sent. The data can be changed on the computer (via the USB port or the Ethernet and the ARSOFT-CFG software, or by copying of the configuration - chapter 12.3). Available parameters of the service: SMTP server address, SMTP port number, username and password, and recipients' addresses (separated with commas, with no spaces, max. length 120 characters). The default section <i>[Email]</i> in the <i>AR407.txt</i> file is the following: <i>SMTP_ServerAddress=smtp.example.com, SMTP_PortNumber=25, UserName=AR407@example.com, Password=SMTPpassword SendTo=user1@domain1.com,user2@domain2.pl,</i>		

12.6.1. EMAIL ALARM NOTIFICATIONS

The use of the email service requires a properly configured Ethernet interface (as described in chapter 12.8 *COMMUNICATION SETTINGS*) and access parameters to the email account (SMTP outgoing mail server). The configuration data of the email client is stored in the *AR407.txt* file. The way to access this data is described above in chapter 12.6, in Table 12.6.2, in item **Email settings and status**. In order to eventually start the configured service, the **Email alarm notifications** parameter must additionally be set to the **Enabled** value (chapter 12.6, Table 12.6.2). The message can be sent to multiple recipients at the same time. Notifications are sent whenever any of the alarms is activated.

The individual components of the email message are created in accordance with the following rules:

- the **Subject** field contains the *NetBIOS name* of the device (default value *AR407*; the description can be found in chapter 12.8, Table 12.8);
- the **From** (Sender) field contains the address of the email (SMTP server) user;
- in the **body** of the message there are the numbers of the active alarms and the numbers, names, units, and measured values of the measurement channels that caused the alarms.

For the purpose of text representation, Windows-1250 code page is used.

If a new alarm occurs, the device attempts to send an email until it is successful or until the relevant alarm is switched off. Because the device only sends notifications about current alarms and does not create a queue (history) to be sent, one must keep in mind that if the mail server is not accessible the alarms taking place at that time may not be noticed.

The number of emails sent is displayed in the device status window (which can be called up using the **[F]+[ESC]** buttons or the **[F]** button, see chapter 10) and in the menu item **Email settings and status** (Table 12.6.2).

By using online SMS gateways, the emails can also be sent in the form of text messages to cell phones operating in GSM networks.

NOTE: 

Before the *AR407.txt* file is modified manually in a text editor, a backup copy of the file must be made (to use later in the event of problems with improper configuration, when default settings were restored).

12.7. DISPLAY SETTINGS



Table 12.7. Configuration parameters in the *Display settings* menu



Parameter 	Range of variability of the parameter and description	Default settings
Screen backlight time	0 ÷ 60 min., increase by 1 min., for the 0 value the illumination is on all the time, the time is counted from the last use of the keypad or the touch screen	0 min. (continuous)
Brightness of the screen	5 ÷ 100 %, change by 5%	100%
Channel and group auto switch time	0 ÷ 60 s, change every 2 s, for the 0 value, the automatic change is off, the time of automatic change of the channel (diagram) and the group in the measurement presentation modes	0 sec.
Chart time range	100 s 300 s 15 min. 30 min. 60 min. 150 min. 5 h 10 h 25 h	100 s
	50 h 5 days 10 days	
Language	Polish, English, the language of the menu (also covers the version of the WWW server page)	Polish

12.8. RADIO, RS485, USB, AND ETHERNET COMMUNICATION SETTINGS

The available interfaces enable communication with Apar measurement devices and with other devices, e.g. a computer, and, consequently, enable the readout of the measured values and configuration of the parameters and the names, as well as access to the archive files (with the exception of the RS485). Moreover, the Ethernet enables displaying information on the operating status and on measurements of the recorder in any web browser (Opera, IE, Firefox, etc.) via the local network or the Internet and sending e-mail alarm notifications (chapter 12.6.1). The WWW server uses the HTTP protocol on the standard port 80. The Internet connection requires a known public IP number and router (modem) configuration. To facilitate access to the networks with varying public IP address, one can start the built-in DDNS server service (described in chapter 12.8.1). **The selection of the TCP and UDP port number used by the recorder and the forwarding of this port in the router and other network parameters configurations should be performed by a qualified person (the network administrator).** Moreover, one must make sure that the firewall does not block the ports and applications being used (ARSOFT-CFG and ARSOFT-LOG, and the MODBUS-TCP protocol). Additional information about the RS485 interface and the MODBUS-RTU/TCP protocols is available in chapters 17÷20.

Table 12.8. Configuration parameters in the *Communication settings* menu

Parameter 	Range of variability of the parameter and description	Default settings
Radio scanning interval	1 min. ÷ 4 hours, from 2 min. in the case of radio channels 4 ÷ 6, change every 1 min.	5 min.
Radio channel number	0 ÷ 6 the selected channel must be set separately in each device (radio sensor) operating in the system	6
USB operation mode	 Available for a computer (device) (2) in order to establish communication with the computer, drivers must be installed (chapter 8); the USB connection is indicated in the lower status bar (chapter 11.1, item b)	Available for a computer
	 USB memory support (host) the presence of the USB memory is indicated in the lower status bar (chapter 11.1), do not connect to the computer's USB port	
RS485 operation mode (MODBUS-RTU)	Master to read measurements from APAR devices (chapter 12.5)	Slave
	Slave for communication with a master device, e.g. a computer	
Baud rate for RS485	2,400 bit/s 4,800 bit/s 9,600 bit/s 19,200 bit/s	19,200 bit/s
	38,400 bit/s 57,600 bit/s 115,200 bit/s	

MODBUS-RTU Slave address	1 ÷ 247	individual address of the device in the RS485 network (chapter 18)	1
Ethernet operation mode	Disabled	Ethernet constantly off (recommended when not in use)	Disabled
	Automatic configuration	the DHCP client is on, parameters IP address , Subnet mask , Default gateway , and DNS server are set automatically	
	Manual configuration	the DHCP client is off, parameters IP address , Subnet mask , and Default gateway are set manually	
	DHCP server	useful for direct connection with a computer; do not use in networks with an existing DHCP server, after this option is set, the device must be restarted	
 NetBIOS name	a unique name of the recorder in the local network; may be used instead of the IP address in order to establish a connection with a computer. Edition of the name (no spaces, max. length 15 characters) is possible on the computer (via the USB port or the Ethernet and the ARSOFT-CFG software, or by copying the configuration - chapter 12.3). The format of a section in the <i>AR407.txt</i> file is the following: <i>[Ethernet] NetBIOSName=AR407</i> . The changed name may not be available on the network immediately (the update time depends on the configuration of the network).		AR407
UDP and TCP ports	80 ÷ 32767 (except for 137)	the port number and the individual IP address of the device for communication using the MODBUS-TCP protocol and with the ARSOFT-CFG and LOG software, and with the web browser (in the address field, enter <i>http://IP address</i> or NetBIOS name , e.g. <i>http://192.168.0.207</i> or <i>http://AR407</i>)	30407
IP address	0.0.0.0 ÷ 255.255.255.255		192.168.0.207
Subnet mask	0.0.0.0 ÷ 255.255.255.255	IP address mask in the local network	255.255.255.0
Default gateway	0.0.0.0 ÷ 255.255.255.255	IP address of the router in the local network	192.168.0.10
DNS server	0.0.0.0 ÷ 255.255.255.255	domain name server address (DNS)	192.168.0.10
Dynamic DNS server client (DDNS)	Disabled	A DDNS service that enables access over the Internet to a recorder connected to a network without a fixed public IP address; an active account in a DDNS service is required; the description can be found in chapter 12.8.1.	Disabled
	Enabled		
 Dynamic DNS settings and status	Configuration data and status of the DDNS service. The data can be edited on the computer (via the USB port or the Ethernet and the ARSOFT-CFG software, or by copying the configuration - chapter 12.3). Available parameters of the service: DDNS server index, host name, username and password. The default section <i>[DDNS]</i> in the <i>AR407.txt</i> file is the following: <i>ServiceIndex=1</i> (0=DYNDNS_ORG, 1=NO_IP_COM, 2=DNSOMATIC_COM), <i>Host=AR407example.ddns.com</i> , <i>UserName= DDNSuser</i> , <i>Password= DDNSpassword</i>		
Website automatic refresh time	0 ÷ 60 s , change every 1 s, in the case of the 0 value, automatic refreshing is switched off (manual refreshing), it is used by the WWW server		5 sec.
 MAC physical address	a unique permanent hardware address of the Ethernet interface (factory-assigned, non-modifiable)		

Notes: (1) - a new scanning period is used in the system after the old expires in all sensors.

It is recommended to set the largest possible value of this time in order to save the batteries in wireless sensors and to increase resistance to any disturbances in the radio communication

- (2)** - connection of the recorder to a USB port of a computer stops recording until the cable is disconnected and blocks the performance of file operations available from the menu level and transmission of files with measurement data via Ethernet from the ARSOFT-LOG level

NOTE:



Do not connect the device in the **USB memory support (host)** mode to the USB port of a computer as this leads to the risk of damage to the ports. **Do not use two USB sockets at the same time.**

12.8.1. DYNAMIC DNS SERVER (DDNS) CLIENT

The DDNS service enables easy access over the Internet to a recorder connected to a network without a fixed public IP address using a friendly host name (Internet address) defined by the user. The service is available only to registered users of popular DDNS services, such as DynDNS (www.dyndns.org), No-IP (www.no-ip.com), and DNS-O-Matic (www.dnsomatic.com).

The use of the DDNS service requires a properly configured Ethernet interface (as described in chapter 12.8 *COMMUNICATION SETTINGS*) and access parameters to the DNS server account. The configuration data of the DDNS service client is stored in the *AR407.txt* file. The way to access this data is described above in chapter 12.8, in Table 12.8, in item **DDNS client settings and status**. In order to eventually start the configured service, one must additionally set the **Dynamic DNS server client** to the value of **Enabled** (Table 12.8). In order for the changes in the DDNS configuration to be implemented immediately, switch off and on the DDNS service, disconnect the Ethernet cable for a brief moment, or restart the device; otherwise, the update will be implemented after not more than 10 minutes after the changes are made. Reliability of the service depends on the availability and load of the DDNS service and delays in the update of the address may reach several dozen minutes.

The public IP address of the network in which the recorder is operating and the status of the DDNS service is displayed in the device status window (which can be called up using the **[F]+[ESC]** buttons or the **[F]** button, see chapter 10) and in the menu item **Dynamic DNS settings and status** (Table 12.8). The *DDNS:OK* status indicates that the last update of the address in the DDNS service was implemented correctly; other codes may be of intermittent nature (e.g. *DDNS:17* which means initiation and *DDNS:13* or *15* - temporary unavailability of the service) or permanent nature, which indicates inadequate Internet connection, improper configuration of the connection or service (codes 2 to 12, e.g. *DDNS:5* means invalid username or password, *DDNS:8* means invalid host name, and *DDNS:11* means unspecified error of the DDNS service).

Access to the Internet using a public IP address (host name) may be blocked by some Internet providers; in such cases, contact your operator's customer service office.

In order to use the services of other NO-IP (*ServiceIndex* =1 in *AR407.txt*) and DynDNS (*ServiceIndex* =0) service providers, configure an account in the Internet service DNS-O-Matic (*ServiceIndex*=2) and in the recorder (the host name can be set as *all.dnsomatic.com* or as the address of the host created in another service supported by DNS-O-Matic).

NOTE:



Before the *AR407.txt* file is modified manually in a text editor, a backup copy must be made of the file (to use later in the event of problems with improper configuration, when default settings were restored).

12.9. ACCESS AND OTHER SETTINGS

Table 12.9. Configuration parameters in the **Access and other settings** menu

Parameter 	Range of variability of the parameter and description	Default settings
Password protection (1)	Disabled - entry into the Main menu and remote access are not password-protected	<i>Manual configuration and remote access</i>
	Manual configuration and remote access - the Main menu and remote access are protected	
	Manual configuration only - only the Main menu of the device is protected	
	Remote access only - only the remote access is protected	
Access password	0000 ÷ 9999 password for entry into the Main menu and for remote access	<i>1111</i>
F button function (chapter 10)	Device status - the status screen (accessible also using the buttons [F]+[ESC])	<i>Device status</i>
	Stop/Start of recording - change of the Recording type parameter to Off or Continuous (chapter 12.2), after the power supply is switched on, the recording is always on (continuous)	
	Copy archives to the USB memory (operation accessible also in the Memory and file options menu, chapter 12.3)	
	Move the archives to the USB memory - the files in the recorder are deleted after they have been copied	

	Disable/Enable sound alarm - change of the Alarm sound signal parameter to Disabled or Enabled (chapter 12.6, Outputs (alarm) configuration menu), after the power supply has been switched on, the sound signaling of all alarm is always on		
	Block/Unblock all alarms – after the power supply has been switched on, all alarm outputs are always in operation in accordance with the programmed characteristics (chapter 12.6)		
	Touch panel lock – touch screen and keypad lock (except for [F])		
Buttons and touch sounds	Disabled	no sound indicating selection of elements of the screen and of hardware buttons	<i>Enabled</i>
	Enabled	the sound indicating selection of elements of the screen and of hardware buttons is active	

Notes: (1) - password protection of remote access applies to a configuration with the ARSOFT-CFG software (for parameter configuration) and the ARSOFT-LOG software (for downloading files with measurements over the Ethernet interface)

12.10. DATE AND TIME

The current time and date are displayed in the status bar (chapter 11.1) in all measurement data presentation modes and are used as time stamps for recording.

In order to supply the internal clock (RTC) when the power supply is cut off, the device is fitted with a CR1220 lithium battery that suffices for at least 5 years of continuous operation.

Table 12.10. Configuration parameters in the **Time and date** menu

Parameter	Range of variability of the parameter
Date (yyyy-mm-dd)	2008-06-01 ÷ 2099-12-31
Time (hh:mm:ss)	00:00:00 ÷ 23:59:59

12.11. DEVICE INFORMATION



Element	Description
1	device type (AR407) and number of used measurement channels (max. 16)
2	recorder's software (firmware) version

Fig. 12.11. Appearance of the **Device information** screen

13. USE AND FUNCTIONS OF USB MEMORY (PENDRIVE)

Due to the stationary (panel) installation of the recorder, it may be useful to use a USB memory to transfer archive data or configuration data.

All the available file and disk operations can be found in the **Main menu** -> **Memory and file options**, chapter 12.3. They enable copying and deleting archive and configuration files and checking the size of the memory and the file system. In the aforementioned operations, the presence of USB memory in the port is detected automatically.

Moreover, it is possible to select a USB memory for continuous storage of the archive. To do so, set the **Archive storage memory** parameter to the **Auto select** value (chapter 12.3) and also in the **Main menu** -> **Communication settings**, set the **USB mode of operation** parameter to the **USB memory support (host)** value, chapter 12.8.

In conclusion, a USB memory that is correctly installed in the socket has the following functions:

- storage of files with saved data in the course of recording

- off-line configuration of the device's parameters (from files *AR407.cfg* and *AR407.txt*, see chapter 12, item 3)
- copying archive files with the *csv* extension from the internal memory

NOTE: 

Do not use two USB sockets **at the same time** from the front as this leads to the risk of damage to the equipment.

14. VIEWING RECORDED MEASUREMENTS AND EVENTS

In order to archive the data, the recorder creates text files with the *csv* extension in the internal memory or the USB memory. Additional, new *csv* files are created each time the power supply is switched on and each time a new recording is started (e.g. when the parameter **Recording type** = **Periodic daily**, new files are created every day). The file name contains the device type (AR407), the identification number (**ID**) (chapter 12.3), and the date and time of creation of the file, e.g. "AR407_1_2016-10-09_10-57-16.csv" (AR407, ID = 1, date = 2016-10-09, time = 10:57:16).

The format of a single data record is the following:

"successive number of the event; date; time; identifier of the event; argument1; ...; argument n; check sum", where n=number of channels (16).

An example of a record containing measurements:

"1;2016-10-09;10:57:16;5;49,5;26,2;19,80;1020;...;8BE2" (measured values: "49,5;26,2;19,80;1020;...").

The types and the identifiers of the recorded events are:

- measurement (identifier of event **5**)
- connection to the USB port (**0**, "USB;CONNECTED")
- disconnection from the USB port (**1**, "USB;DISCONNEC")
- loading of a new configuration (identifier of event **3**), values of arguments:
 - "NEW;ON-LINE" - parameter configuration via the USB port, the RS485 port, or the Ethernet (on-line)
 - "NEW;OFF-LINE" - parameter configuration by way of modification of the *AR407.cfg* file (off-line)
 - "NEW;USER" - parameter configuration from the keypad and touch screen (user) level
 - "NEW;CH_TEXT" - name configuration by way of modification of the *AR407.txt* file
- creation of a new *csv* file (**4**, "ID;xxxx", where xxxx - value of the **Identification number ID** parameter of the device, chapter 12.3, Table 12.3)

In order to present the recorded results graphically or as text or to print them, the data must be imported into the ARSOFT-LOG software via the USB or using the Ethernet interface. The quickest possible method is to import the data via the computer's USB; it is recommended in case of very large files (hundreds of megabytes and larger). The ARSOFT-LOG software also enables detecting unauthorized modifications of the archive.

As an alternative, *csv* files can be edited in spreadsheet software (e.g. OpenOffice Calc, Microsoft Excel) and in text editors (Windows WordPad, Notepad++, etc.).

NOTE: 

When the parameter **Archive storage memory** = **Auto select** (chapter 12.3) then if the USB memory is installed or removed in the course of recording, a new *csv* file is created where the successive numbers of events are continued from the previous file.

15. MESSAGE AND ERROR SIGNALING

The measurement errors present in the field of the measured values in all presentation modes:

- - no measurement data from sensors/devices, possible causes (tips are given in chapter 16):
 - a) waiting for the measurement data after the power supply is switched on (for a time not longer than the **Radio scanning interval** defined in the **Communication settings**, chapter 12.8),
 - b) no or disturbed communication with the sensor (indicated after two failed attempts, for radio sensors made with a **Radio scanning interval**)
- HI-- - measurement range of the sensor exceeded from the top or incorrect operation of the sensor (e.g. signal connected improperly to the measurement input or defective)

- LO-- - measurement range of the sensor exceeded from the bottom or incorrect operation of the sensor (e.g. signal connected improperly to the measurement input or defective)
- LBAT** - low level of the battery of the radio sensor (the battery must be replaced with a new one - see the user's instruction for the sensor)

Also, the recorder has a clear way of informing of its operating status and the status of the file or disk operations being performed. In order to close the message window appearing in the display, use the **[SET]** or **[ESC]** button.

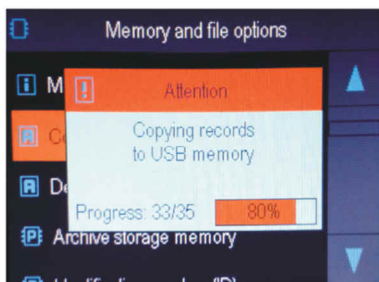

Fig. 15. Appearance of an example message window.

16. IMPORTANT COMMENTS PERTAINING TO OPERATION. PROBLEM SOLVING



In the case of normal, undisturbed radio transmission, sensors of the AR43x series are activated periodically in order to send current measurement data in response to a request of the AR407. The activation period is set in the AR407 recorder in the **Radio scanning interval (Main Menu->Communication settings**, chapter 12.8). After the power supply is switched on, the recorder waits for the measurement data, which is indicated with the message "-----" in the measured values field for a time not longer than that period.

In the event of problems with communication between the sensors/devices and the AR407 recorder (indicated for individual measurement channels during operation with the message "-----" and also with the value 31999 in the archive file in the measured value field), it is necessary to:

- a) check the configuration of the operating parameters in accordance with the indications contained in chapt.12.5 and 17
- b) reduce the distance or change the location of the AR43x devices or antennas in relation to each other (using the accessory antenna cable) in order to avoid such obstacles as walls, floor slabs, furniture, etc.
- b) change the radio channel in all devices in the system (in each separately) to a different one
- c) check the battery level in the AR43x sensor and, if necessary, replace the battery with a new one and set the longest possible **Radio scanning interval** (which also extends the operating time of the battery in the sensors)
- d) consider switching on the retransmitter function in the AR43x sensor (a description can be found in the user's instruction for the sensor), whereby:
 - the retransmitter requires external USB power supply (the battery is only a backup power supply source)
 - the retransmitter must be registered in the system also as a sensor (must have an ID assigned)
 - the retransmitter must be in the radio range of the AR407 recorder; the measurements are refreshed every 5s
 - in the system there may be a maximum of 3 retransmitters (each one must have a different number assigned)

In order to ensure problem-free and optimum operation of the recorder, please observe the following guidelines:

- do not disconnect the device from the computer in the course of communication via the USB interface, which is indicated by the **[R/W]** and **[Tx/Rx]** icons. USB communication is in place when the internal memory is operated and in the course of operation of the ARSOFT-CFG software.
- delete unnecessary files from the internal memory or the USB memory before new recording start
- save backup copies in external memories (USB, computer disks, etc.) of the current configuration files (*AR407.cfg* and *AR407.txt*) to be used in the event of problems
- **do not allow power supply loss during data saving** as this may lead to the risk of errors in the FAT file system and, consequently, to problems with recording/reading of data and loss of the current controller configuration and reverting to the default configuration. If this happens, perform the following actions from the **Main menu** level of the AR407 device or using a computer connected via the USB port:

1. copy (if possible) the existing archive files to an external memory (a USB memory or the computer's disk)
 2. format the internal memory
 3. configure the recorder (manually, on-line, or off-line by restoring the configuration file copies if they have been made by the user)
- **do not** establish communication with the device **simultaneously** from many applications of the same type (ARSOFT-CFG/LOG)
 - **do not use sharp-edged objects to work with the touch screen**
 - avoid exposing the device to direct sunlight and other sources of intensive heat
 - connection of the recorder to a USB port of a computer stops recording until the cable is disconnected and blocks the performance of file operations available from the menu level and transmission of files with measurement data via Ethernet from the ARSOFT-LOG level

17. RS485 COMMUNICATION INTERFACE (acc. to EIA RS-485)

The installation specification for the RS485 interface is the following:

- maximum cable length - 1 km (observe the installation guidelines, chapter 2, sub-items b, c, and d)
- maximum number of devices in a RS485 line - 30, in order to increase the number, use RS485/RS485 amplifiers
- termination and polarizing resistors when the MASTER is at the start of the line (Fig. 17):
 - at the start of the line - $2 \times 820 \Omega$ to the ground and +5 V of the MASTER and 150Ω between lines
 - at the end of the line - 150Ω between lines
- termination and polarizing resistors when the MASTER is in the center of the line:
 - at the converter - $2 \times 820 \Omega$, to the ground and +5 V of the converter
 - at both ends of the line - 150Ω each between lines

Equipment from different manufacturers that form the RS485 network (e.g. RS485 converters/USB) may have integrated polarizing and terminating resistors; in such a case there is no need to use external elements.

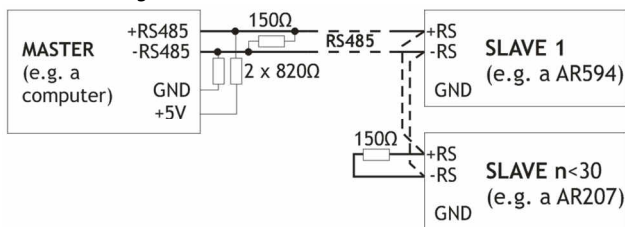

Fig. 17. Pictorial diagram of the RS485 network

18. MODBUS–RTU SERIAL TRANSMISSION PROTOCOL

The MODBUS-RTU protocol is accessible to the RS485 interface and the USB. The parameters used by this service are described in chapter 12.8. The MODBUS-RTU protocol in the Master mode (readout of data from Apar devices) is available only for the RS485.

Character format : 8 bits, 1 stop bit, no parity bit

Available functions : READ - 3 or 4 for the Slave mode (4 for the Master mode) , WRITE – 6 (only in the Slave mode)

Table 18.1. Request frame format for the READ function (frame length - 8 bytes):

address of the device	function 4 or 3	address of the read register from Table 20 (chapter 20)	number of read registers: 1 ÷ 32 (0x0020)	CRC check sum
1 byte	1 byte	2 bytes (HB-LB)	2 bytes (HB-LB)	2 bytes (LB-HB)

Example 18.1. Reading of a register with address 0: 0x01 - 0x04 - 0x0000 - 0x0001 - 0x31CA

Table 18.2. Request frame format for the WRITE function (frame length - 8 bytes):

address of the device	function 6	address of the write register from Table 20 (chapter 20)	write register value	CRC check sum
1 byte	1 byte	2 bytes (HB-LB)	2 bytes (HB-LB)	2 bytes (LB-HB)

Example 18.2. Write in a register with address 10 (0xA) with the 0 value: 0x01 - 0x06 - 0x000A - 0x0000 - 0xA9C8

Table 18.3. Response frame format for the READ function (minimum frame length - 7 bytes):

address of the device	function 4 or 3	number of bytes in the data field (max. 32*2=64B)	data field - register value	CRC check sum
1 byte	1 byte	1 byte	2 ÷ 64 bytes (HB-LB)	2 bytes (LB-HB)

Example 18.3. Response frame for register value equal to 0: 0x01 - 0x04 - 0x02 - 0x0000 - 0xB930

Table 18.4. Response frame format for the WRITE function (frame length - 8 bytes):

copy of the request frame for the WRITE function (Table 18.2)

Table 18.5. Special answer (errors: function field = 0x84 or 0x83 in the case of the READ function and 0x86 in the case of the WRITE function):

Error code (HB-LB in the data field)	Error description
0x0001	non-existing register address
0x0002	wrong write register value
0x0003	improper function number

Example 18.5. Error frame for a non-existing read register address:

0x01 - 0x84 - 0x02 - 0x0001 - 0x5130

19. MODBUS-TCP SERIAL TRANSMISSION PROTOCOL

The MODBUS-TCP protocol is accessible to the Ethernet (RJ45) interface and uses the TCP/IP transport layer. The parameters used by the service, to include the TCP port number, are described in chapter 12.8.

Available functions : READ - 3 or 4, WRITE - 6

Table 19.1. Request frame format of the MODBUS-TCP protocol for the READ and WRITE functions (frame length - 12B)

Heading of the MODBUS protocol (7 bytes)			Function code (READ or WRITE)	register address from Table 20 (chapter 20)	number of read registers (1÷32) or value of read register
Transaction and protocol identifiers	Length field (value = 6)	Unit identifier			
4 bytes	2 bytes	1 byte	1 byte	2 bytes (HB-LB)	2 bytes (HB-LB)

Example 19.1. Reading of a register with address 0: 0x00-0x00-0x00-0x00-0x00-0x06-0xFF-0x04-0x0000-0x0001

Table 19.2. Response frame format for the READ function (minimum frame length - 11 bytes):

Heading of the MODBUS protocol (7 bytes)			Function code (READ)	number of bytes in the data field (2 ÷ 64)	data field - register value (2B)
Transaction and protocol identifiers	Length field (maximum 67)	Unit identifier			
4 bytes	2 bytes	1 byte	1 byte	1 byte	2 ÷ 64 bytes (HB-LB)

Example 19.2. Response frame for register value equal to 0:

0x00 - 0x00 - 0x00 - 0x00 - 0x00 - 0x05 - 0xFF - 0x04 - 0x01 - 0x0000

Table 19.3. Response frame format for the WRITE function (frame length - 12 bytes)

copy of the request frame for the WRITE function (Table 19.1)

The error codes are the same as in the case of the MODBUS-RTU protocol (Table 18.5)

Example 19.4. Error frame for a non-existing read register address:

0x00 - 0x00 - 0x00 - 0x00 - 0x00 - 0x05 - 0xFF - 0x84 - 0x02 - 0x0001

20. MAP OF DEVICE REGISTERS FOR THE MODBUS-RTU/TCP

Table 20. Map of registers for the MODBUS-RTU and MODBUS-TCP protocols

Register address HEX (DEC)	Range of variability or value of the register (HEX or DEC)	Description of register and access type (R- read only register, R/W - read and write register)	
0x00 (0)	0	not used	R
0x01 (1)	407	device type identifier	R
0x02 (2)	100 ÷ 999	recorder's software (firmware) version	R
0x03 (3)	-300 ÷ 800	temperature of the AR18x wired probe, resolution 0.1 °C, no comma	R
0x04 (4)	0 ÷ 15	current status of outputs 1, 2, 3, 4: bits 3, 2, 1, 0 bit=1 means the output is switched on	R
0x05 ÷ 0x0B	0	not used or reserved	R
0x0C ÷ 0x1B	-9999 ÷ 19999	value of measurement channels 1÷16 (in the U2 code, 1 register/channel, 16-bit)	R
0x1C (28)	0 ÷ 6	day of the week in the internal RTC clock (counted based on the date)	R
0x1D (29)	0x0101 ÷ 0x630C	years (HB) and months (LB)	Internal real time clock (RTC, chapter 12.10)
0x1E(30)	0x0100 ÷ 0x1F17	days (HB) and hours (LB)	
0x1F (31)	0x0000 ÷ 0x3B3B	minutes (HB) and seconds (LB)	
0x20 (32)	0x0101 ÷ 0x630C	years (HB) and months (LB)	
0x21 (33)	0x0100 ÷ 0x1F17	days (HB) and hours (LB)	Parameter Start of the time limit (chapter 12.2)
0x22 (34)	0x0000 ÷ 0x3B3B	minutes (HB) and seconds (LB)	
0x23 (35)	0x0101 ÷ 0x630C	years (HB) and months (LB)	Parameter End of the time limit (chapter 12.2)
0x24 (36)	0x0100 ÷ 0x1F17	days (HB) and hours (LB)	
0x25 (37)	0x0000 ÷ 0x3B3B	minutes (HB) and seconds (LB)	
0x26 (38)	1 ÷ 28800	Parameter Data recording interval (chapter 12.2) – number of seconds [s]	R/W
0x27 (39)	0 ÷ 5	Parameter Recording type (chapter 12.2)	R/W
0x28 (40)	0 ÷ 15	Parameter Selection of permission channel (chapter 12.2)	R/W
0x29 (41)	-9999÷19999	Parameter Permission threshold value (chapter 12.2)	R/W
0x2A (42)	0 ÷ 1	Parameter Archive storage memory (chapter 12.3)	R/W
Configuration parameters for the measurement channel number KP = 0÷15, 0=channel 1, 15=channel 16; a description can be found in chapter 12.4			
0x2B + KP*11	0 ÷ 3	Parameter Assigned sensor type (chapter 12.4)	R/W
0x2C + KP*11	0 ÷ 1	reserved	R
0x2D + KP*11	0 ÷ 9999	reserved	R
0x2E + KP*11	0 ÷ 16	Parameter Address of assigned sensor (ID)	R/W
0x2F + KP*11	0 ÷ 9999	Parameter Register address to read for RS485	R/W
0x30 + KP*11	0 ÷ 3	Parameter Decimal dot position for the readout from the RS485 sensor	R/W
0x31 + KP*11	-9999 ÷ 19999	Parameter Bottom of indication range for graphics	R/W
0x32 + KP*11	-9999 ÷ 19999	Parameter Top of indication range for graphics	R/W
0x33 + KP*11	0 ÷ 8	Parameter Assignment of alarm outputs	R/W
0x34 + KP*11	0 ÷ 8	Parameter Assignment of measurement group	R/W
0x35 + KP*11	0 ÷ 22	Parameter Background color	R/W
Configuration parameters of an alarm channel numbered KA = 0 ÷ 3 (0=channel 1, 3=channel 4), description in chapter 12.6			

0xDB + KA*5	0 ÷ 4	Parameter Type of alarm (chapter 12.6)	R/W
0xDC + KA*5	0 ÷ 5000	Parameter Alarm hysteresis	R/W
0xDD + KA*5	-9999 ÷ 19999	Parameter Alarm value	R/W
0xDE + KA*5	1 ÷ 100	Parameter Output signal value - percentage [%]	R/W
0xDF + KA*5	1 ÷ 3600	Parameter Output signal pulse period - number of seconds [s]	R/W
0xEF (239)	0 ÷ 1	Parameter Alarm sound signal	R/W
0xF0 (240)	0 ÷ 1	Parameter Email alarm notifications (chapter 12.6.1)	R/W
0xF1 (241)	0 ÷ 6	Parameter Function of the F button (chapter 12.9)	R/W
0xF2 (242)	0 ÷ 1	Parameter Buttons and touch sound (chapter 12.9)	R/W
0xF3 (243)	0 ÷ 3	Parameter Password protection (chapter 12.9)	R/W
0xF4 (244)	0 ÷ 9999	Parameter Password (chapter 12.9)	R/W
0xF5 (245)	0 ÷ 9999	Parameter Identification number ID (chapter 12.3)	R/W
0xF6 (246)	0 ÷ 60	Parameter Screen backlight time (chapter 12.7)	R/W
0xF7 (247)	20 ÷ 100	Parameter Brightness of the screen (chapter 12.7)	R/W
0xF8 (248)	0 ÷ 60	Parameter Channel and group auto switch time (chapter 12.7)	R/W
0xF9 (249)	0 ÷ 11	Parameter Chart time range (chapter 12.7)	R/W
0xFA (250)	0 ÷ 1	Parameter Language (chapter 12.7)	R/W
0xFB (251)	60 ÷ 14400	Parameter Radio scanning interval (chapter 12.8) - number of seconds [s]	R/W
0xFC (252)	0 ÷ 6	Parameter Radio channel number (chapter 12.8)	R/W
0xFD (253)	0 ÷ 1	Parameter USB operation mode (chapter 12.8)	R/W
0xFE (254)	0 ÷ 1	Parameter RS485 operating mode (MODBUS-RTU) (chapter 12.8)	R/W
0xFF (255)	1 ÷ 247	Parameter MODBUS-RTU slave address (chapter 12.8)	R/W
0x100 (256)	0 ÷ 6	Parameter Baud rate for the RS485 (chapter 12.8)	R/W
0x101 (257)	0 ÷ 3	Parameter Ethernet operation mode (chapter 12.8)	R/W
0x102 (258)	80 ÷ 32767	Parameter UDP and TCP port (chapter 12.8)	R/W
0x103 (259)	0x0000 ÷ 0xFFFF	Octet4 (HB), Octet3 (LB)	Parameter IP address (chapter 12.8)
0x104 (260)	0x0000 ÷ 0xFFFF	Octet2 (HB), Octet1 (LB)	
0x105 (261)	0x0000 ÷ 0xFFFF	Octet4 (HB), Octet3 (LB)	Parameter Subnet mask (chapter 12.8)
0x106 (262)	0x0000 ÷ 0xFFFF	Octet2 (HB), Octet1 (LB)	
0x107 (263)	0x0000 ÷ 0xFFFF	Octet4 (HB), Octet3 (LB)	Parameter Default gate (chapter 12.8)
0x108 (264)	0x0000 ÷ 0xFFFF	Octet2 (HB), Octet1 (LB)	
0x109 (265)	0x0000 ÷ 0xFFFF	Octet4 (HB), Octet3 (LB)	Parameter DNS server (chapter 12.8)
0x10A (266)	0x0000 ÷ 0xFFFF	Octet2 (HB), Octet1 (LB)	
0x10B ÷ 0x10C	0	not used	R/W
0x10D (269)	0 ÷ 1	Parameter Dynamic DNS server client (chapter 12.8.1)	R/W
0x10E (270)	0 ÷ 60	Parameter Website automatic refresh time (chapter 12.8)	R/W

21. USER'S NOTES
