

## TRENCHSTOP™ RC-Series for hard switching applications

IGBT with integrated diode in packages offering space saving advantage

### Features:

TRENCHSTOP™ Reverse Conducting (RC) technology for 600V applications offering

- Optimised  $V_{CEsat}$  and  $V_F$  for low conduction losses
- Smooth switching performance leading to low EMI levels
- Very tight parameter distribution
- Operating range of 1 to 20kHz
- Maximum junction temperature 175°C
- Dynamically stress tested
- Short circuit capability of 5µs
- Best in class current versus package size performance
- Qualified according to AECQ101
- Pb-free lead plating; RoHS compliant (for PG-TO252: solder temperature 260°C, MSL1)

Complete product spectrum and PSpice Models:  
<http://www.infineon.com/igbt/>

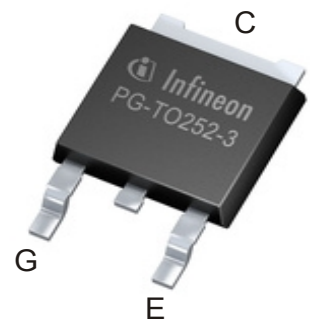
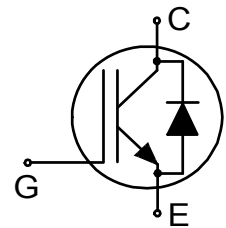

### Applications:

- HID lighting
- Piezo injection



### Key Performance and Package Parameters

| Type       | $V_{CE}$ | $I_C$ | $V_{CEsat}, T_{vj}=25^\circ\text{C}$ | $T_{vjmax}$ | Marking | Package    |
|------------|----------|-------|--------------------------------------|-------------|---------|------------|
| AIHD06N60R | 600V     | 6A    | 1.65V                                | 175°C       | AH06DR  | PG-TO252-3 |



---

TRENCHSTOP™ RC-Series for hard switching applications

**Table of Contents**

Description ..... 1

Table of Contents ..... 2

Maximum Ratings ..... 3

Thermal Resistance ..... 3

Electrical Characteristics ..... 4

Electrical Characteristics Diagrams ..... 6

Package Drawing .....13

Testing Conditions .....14

Revision History .....15

Disclaimer .....16

## TRENCHSTOP™ RC-Series for hard switching applications

## Maximum Ratings

| Parameter   | Symbol      | Value       | Unit             |
|---|-------------|-------------|------------------|
| Collector-emitter voltage   | $V_{CE}$    | 600         | V                |
| DC collector current, limited by $T_{vjmax}$<br>$T_C = 25^\circ\text{C}$<br>$T_C = 100^\circ\text{C}$   | $I_C$       | 12.0<br>6.0 | A                |
| Pulsed collector current, $t_p$ limited by $T_{vjmax}$  | $I_{Cpuls}$ | 18.0        | A                |
| Turn off safe operating area $V_{CE} \leq 600\text{V}$ , $T_{vj} \leq 175^\circ\text{C}$  | -           | 18.0        | A                |
| Diode forward current, limited by $T_{vjmax}$<br>$T_C = 25^\circ\text{C}$<br>$T_C = 100^\circ\text{C}$  | $I_F$       | 12.0<br>6.0 | A                |
| Diode pulsed current, $t_p$ limited by $T_{vjmax}$  | $I_{Fpuls}$ | 18.0        | A                |
| Gate-emitter voltage  | $V_{GE}$    | $\pm 20$    | V                |
| Short circuit withstand time<br>$V_{GE} = 15.0\text{V}$ , $V_{CC} \leq 400\text{V}$<br>Allowed number of short circuits < 1000<br>Time between short circuits: $\geq 1.0\text{s}$<br>$T_{vj} = 150^\circ\text{C}$ | $t_{SC}$    | 5           | $\mu\text{s}$    |
| Power dissipation $T_C = 25^\circ\text{C}$  | $P_{tot}$   | 100.0       | W                |
| Operating junction temperature  | $T_{vj}$    | -40...+175  | $^\circ\text{C}$ |
| Storage temperature   | $T_{stg}$   | -55...+175  | $^\circ\text{C}$ |
| Soldering temperature,<br>reflow soldering (MSL1 according to JEDEC J-STA-020)  |             | 260         | $^\circ\text{C}$ |

## Thermal Resistance

| Parameter   | Symbol        | Conditions | Value |      |      | Unit |
|---|---------------|------------|-------|------|------|------|
|   |               |            | min.  | typ. | max. |      |
| <b>R<sub>th</sub> Characteristics</b>                                   |               |            |       |      |      |      |
| IGBT thermal resistance, <sup>1)</sup><br>junction - case               | $R_{th(j-c)}$ |            | -     | -    | 1.50 | K/W  |
| Diode thermal resistance, <sup>2)</sup><br>junction - case              | $R_{th(j-c)}$ |            | -     | -    | 3.60 | K/W  |
| Thermal resistance, min. footprint<br>junction - ambient                | $R_{th(j-a)}$ |            | -     | -    | 75   | K/W  |
| Thermal resistance, 6cm <sup>2</sup> Cu on<br>PCB<br>junction - ambient | $R_{th(j-a)}$ |            | -     | -    | 50   | K/W  |

<sup>1)</sup> R<sub>th</sub>/Z<sub>th</sub> based on single cooling pulse. Please be aware that a correct R<sub>th</sub> measurement of the IGBT, is not possible using a thermocouple.

<sup>2)</sup> R<sub>th</sub>/Z<sub>th</sub> based on single cooling pulse. Please be aware that a correct R<sub>th</sub> measurement of the Diode, is not possible using a thermocouple.

## TRENCHSTOP™ RC-Series for hard switching applications

Electrical Characteristic, at  $T_{vj} = 25^{\circ}\text{C}$ , unless otherwise specified

| Parameter                            | Symbol        | Conditions  | Value  |              |           | Unit          |
|--------------------------------------|---------------|---|--------|--------------|-----------|---------------|
|                                      |               |   | min.   | typ.         | max.      |               |
| <b>Static Characteristic</b>         |               |   |        |              |           |               |
| Collector-emitter breakdown voltage  | $V_{(BR)CES}$ | $V_{GE} = 0\text{V}, I_C = 0.20\text{mA}$   | 600    | -            | -         | V             |
| Collector-emitter saturation voltage | $V_{CEsat}$   | $V_{GE} = 15.0\text{V}, I_C = 6.0\text{A}$<br>$T_{vj} = 25^{\circ}\text{C}$<br>$T_{vj} = 175^{\circ}\text{C}$ | -<br>- | 1.65<br>1.85 | 2.10<br>- | V             |
| Diode forward voltage                | $V_F$         | $V_{GE} = 0\text{V}, I_F = 6.0\text{A}$<br>$T_{vj} = 25^{\circ}\text{C}$<br>$T_{vj} = 175^{\circ}\text{C}$    | -<br>- | 1.70<br>1.70 | 2.10<br>- | V             |
| Gate-emitter threshold voltage       | $V_{GE(th)}$  | $I_C = 0.11\text{mA}, V_{CE} = V_{GE}$  | 4.3    | 5.0          | 5.7       | V             |
| Zero gate voltage collector current  | $I_{CES}$     | $V_{CE} = 600\text{V}, V_{GE} = 0\text{V}$<br>$T_{vj} = 25^{\circ}\text{C}$<br>$T_{vj} = 175^{\circ}\text{C}$ | -<br>- | -<br>250     | 40<br>-   | $\mu\text{A}$ |
| Gate-emitter leakage current         | $I_{GES}$     | $V_{CE} = 0\text{V}, V_{GE} = 20\text{V}$   | -      | -            | 100       | nA            |
| Transconductance                     | $g_{fs}$      | $V_{CE} = 20\text{V}, I_C = 6.0\text{A}$  | -      | 3.4          | -         | S             |
| Integrated gate resistor             | $r_G$         |   |        | none         |           | $\Omega$      |

Electrical Characteristic, at  $T_{vj} = 25^{\circ}\text{C}$ , unless otherwise specified

| Parameter  | Symbol      | Conditions   | Value |      |      | Unit |
|--|-------------|--|-------|------|------|------|
|  |             |  | min.  | typ. | max. |      |
| <b>Dynamic Characteristic</b>  |             |  |       |      |      |      |
| Input capacitance  | $C_{ies}$   | $V_{CE} = 25\text{V}, V_{GE} = 0\text{V}, f = 1\text{MHz}$   | -     | 470  | -    | pF   |
| Output capacitance   | $C_{oes}$   |  | -     | 24   | -    |      |
| Reverse transfer capacitance   | $C_{res}$   |  | -     | 14   | -    |      |
| Gate charge  | $Q_G$       | $V_{CC} = 480\text{V}, I_C = 6.0\text{A},$<br>$V_{GE} = 15\text{V}$  | -     | 48.0 | -    | nC   |
| Short circuit collector current<br>Max. 1000 short circuits<br>Time between short circuits: $\geq 1.0\text{s}$ | $I_{C(SC)}$ | $V_{GE} = 15.0\text{V}, V_{CC} \leq 400\text{V},$<br>$t_{SC} \leq 5\mu\text{s}$<br>$T_{vj} = 25^{\circ}\text{C}$ | -     | 46   | -    | A    |

## Switching Characteristic, Inductive Load

| Parameter   | Symbol       | Conditions   | Value |      |      | Unit |
|---|--------------|--|-------|------|------|------|
|   |              |  | min.  | typ. | max. |      |
| <b>IGBT Characteristic, at <math>T_{vj} = 25^{\circ}\text{C}</math></b> |              |  |       |      |      |      |
| Turn-on delay time  | $t_{d(on)}$  | $T_{vj} = 25^{\circ}\text{C},$<br>$V_{CC} = 400\text{V}, I_C = 6.0\text{A},$<br>$V_{GE} = 0.0/15.0\text{V},$<br>$R_{G(on)} = 23.0\Omega, R_{G(off)} = 23.0\Omega,$<br>$L_{\sigma} = 60\text{nH}, C_{\sigma} = 40\text{pF}$<br>$L_{\sigma}, C_{\sigma}$ from Fig. E | -     | 12   | -    | ns   |
| Rise time   | $t_r$        |  | -     | 7    | -    | ns   |
| Turn-off delay time   | $t_{d(off)}$ |  | -     | 127  | -    | ns   |
| Fall time   | $t_f$        |  | -     | 152  | -    | ns   |
| Turn-on energy  | $E_{on}$     |  | -     | 0.11 | -    | mJ   |
| Turn-off energy   | $E_{off}$    |  | -     | 0.22 | -    | mJ   |
| Total switching energy  | $E_{ts}$     |  | -     | 0.33 | -    | mJ   |

## TRENCHSTOP™ RC-Series for hard switching applications

Diode Characteristic, at  $T_{vj} = 25^{\circ}\text{C}$ 

|  |              |  |   |      |   |                        |
|--|--------------|--|---|------|---|------------------------|
| Diode reverse recovery time                                      | $t_{rr}$     | $T_{vj} = 25^{\circ}\text{C}$ ,<br>$V_R = 400\text{V}$ ,<br>$I_F = 6.0\text{A}$ ,<br>$di_F/dt = 800\text{A}/\mu\text{s}$ | - | 68   | - | ns                     |
| Diode reverse recovery charge                                    | $Q_{rr}$     |  | - | 0.37 | - | $\mu\text{C}$          |
| Diode peak reverse recovery current                              | $I_{rrm}$    |  | - | 12.0 | - | A                      |
| Diode peak rate of fall of reverse recovery current during $t_b$ | $di_{rr}/dt$ |  | - | -211 | - | $\text{A}/\mu\text{s}$ |

## Switching Characteristic, Inductive Load

| Parameter | Symbol | Conditions | Value |      |      | Unit |
|-----------|--------|------------|-------|------|------|------|
|           |        |            | min.  | typ. | max. |      |

IGBT Characteristic, at  $T_{vj} = 175^{\circ}\text{C}$ 

|                        |              |   |   |      |   |    |
|------------------------|--------------|---|---|------|---|----|
| Turn-on delay time     | $t_{d(on)}$  | $T_{vj} = 175^{\circ}\text{C}$ ,<br>$V_{CC} = 400\text{V}$ , $I_C = 6.0\text{A}$ ,<br>$V_{GE} = 0.0/15.0\text{V}$ ,<br>$R_{G(on)} = 23.0\Omega$ , $R_{G(off)} = 23.0\Omega$ ,<br>$L\sigma = 60\text{nH}$ , $C\sigma = 40\text{pF}$<br>$L\sigma$ , $C\sigma$ from Fig. E | - | 12   | - | ns |
| Rise time              | $t_r$        |   | - | 10   | - | ns |
| Turn-off delay time    | $t_{d(off)}$ |   | - | 164  | - | ns |
| Fall time              | $t_f$        |   | - | 171  | - | ns |
| Turn-on energy         | $E_{on}$     |   | - | 0.20 | - | mJ |
| Turn-off energy        | $E_{off}$    |   | - | 0.36 | - | mJ |
| Total switching energy | $E_{ts}$     |   | - | 0.56 | - | mJ |

Diode Characteristic, at  $T_{vj} = 175^{\circ}\text{C}$ 

|  |              |   |   |      |   |                        |
|--|--------------|---|---|------|---|------------------------|
| Diode reverse recovery time                                      | $t_{rr}$     | $T_{vj} = 175^{\circ}\text{C}$ ,<br>$V_R = 400\text{V}$ ,<br>$I_F = 6.0\text{A}$ ,<br>$di_F/dt = 800\text{A}/\mu\text{s}$ | - | 74   | - | ns                     |
| Diode reverse recovery charge                                    | $Q_{rr}$     |   | - | 0.80 | - | $\mu\text{C}$          |
| Diode peak reverse recovery current                              | $I_{rrm}$    |   | - | 17.0 | - | A                      |
| Diode peak rate of fall of reverse recovery current during $t_b$ | $di_{rr}/dt$ |   | - | -237 | - | $\text{A}/\mu\text{s}$ |

TRENCHSTOP™ RC-Series for hard switching applications

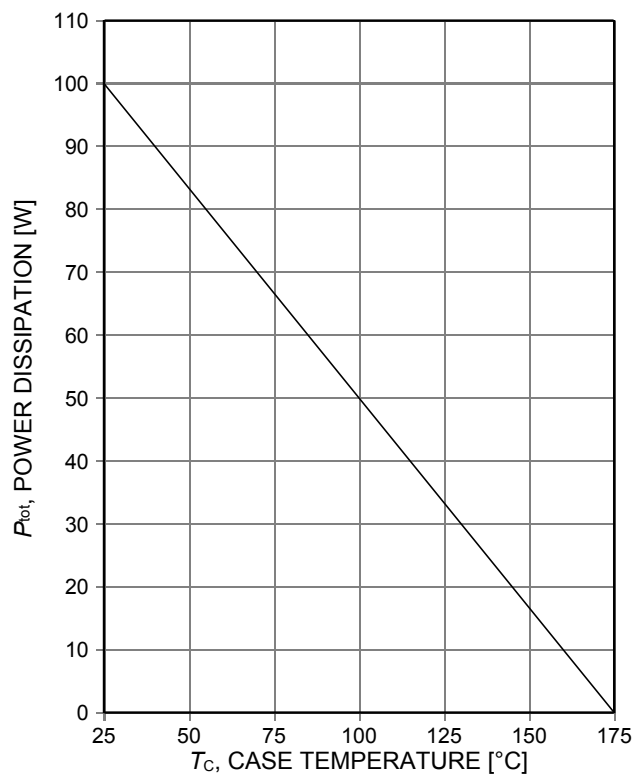

Figure 1. Power dissipation as a function of case temperature ( $T_{vj} \leq 175^\circ\text{C}$ )

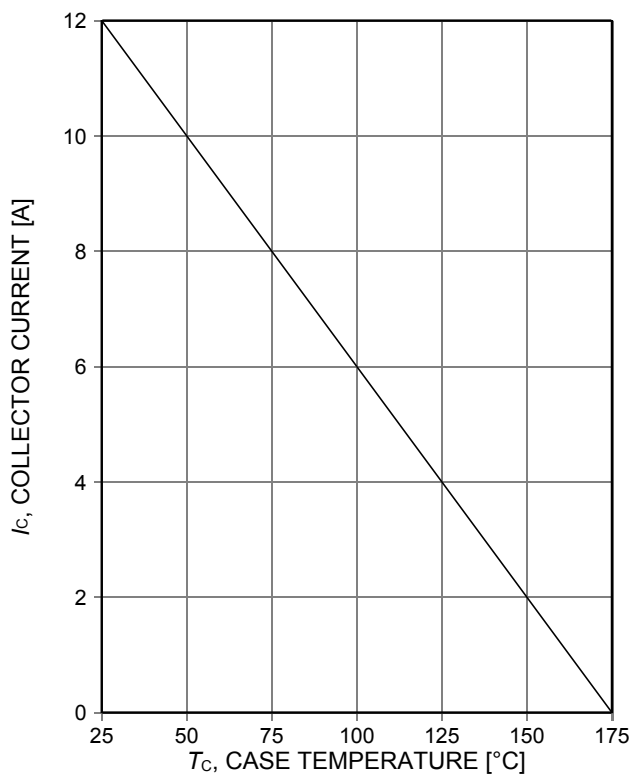

Figure 2. Collector current as a function of case temperature ( $V_{GE} \geq 15\text{V}$ ,  $T_{vj} \leq 175^\circ\text{C}$ )

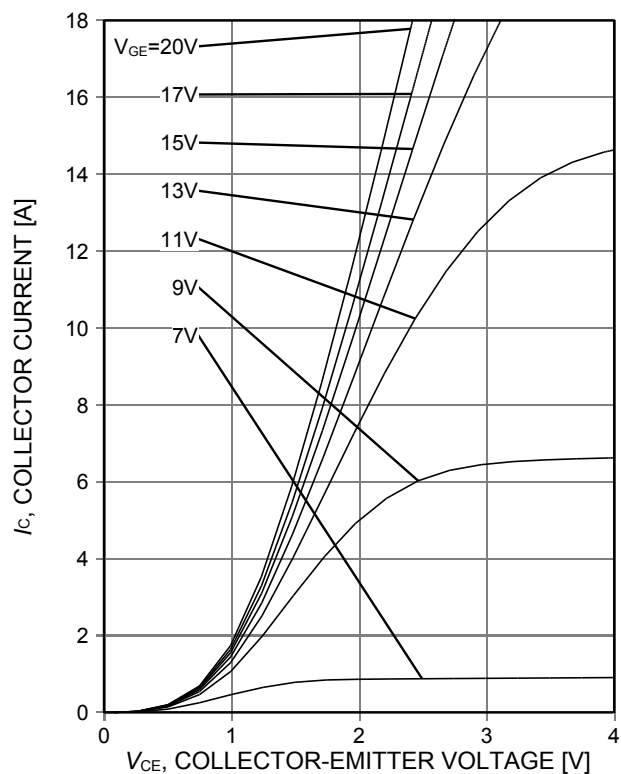

Figure 3. Typical output characteristic ( $T_{vj} = 25^\circ\text{C}$ )

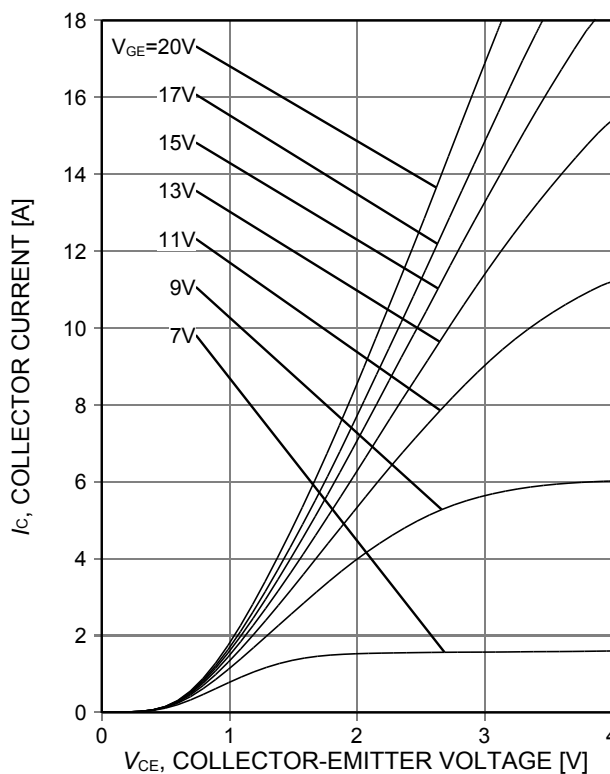

Figure 4. Typical output characteristic ( $T_{vj} = 175^\circ\text{C}$ )

TRENCHSTOP™ RC-Series for hard switching applications

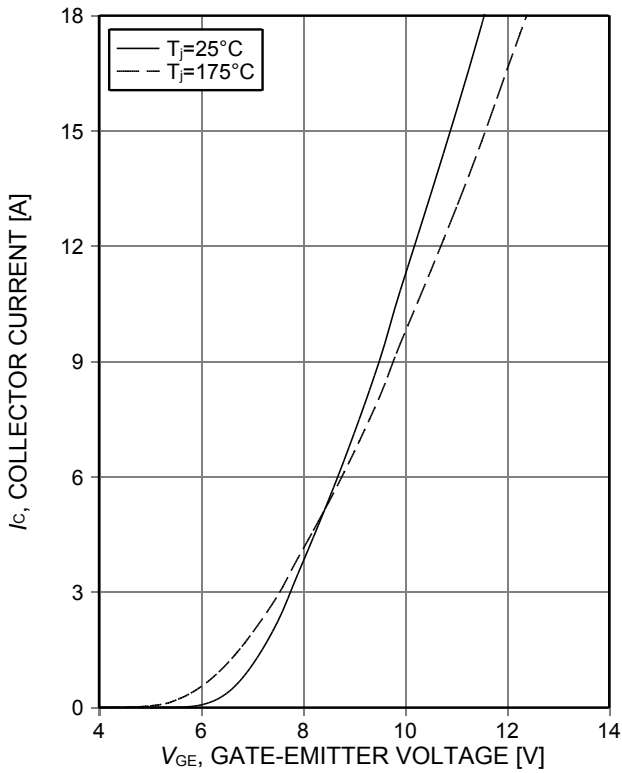

Figure 5. **Typical transfer characteristic**  
( $V_{CE}=10V$ )

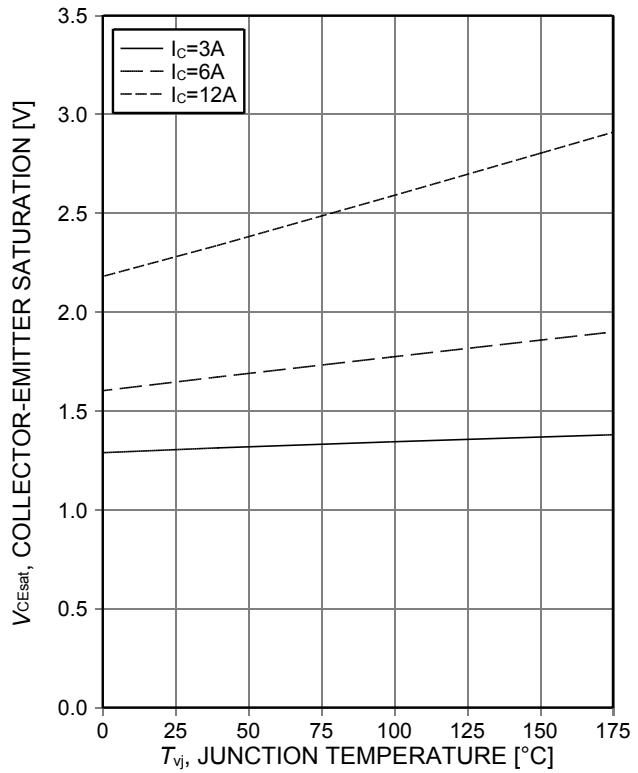

Figure 6. **Typical collector-emitter saturation voltage as a function of junction temperature**  
( $V_{GE}=15V$ )

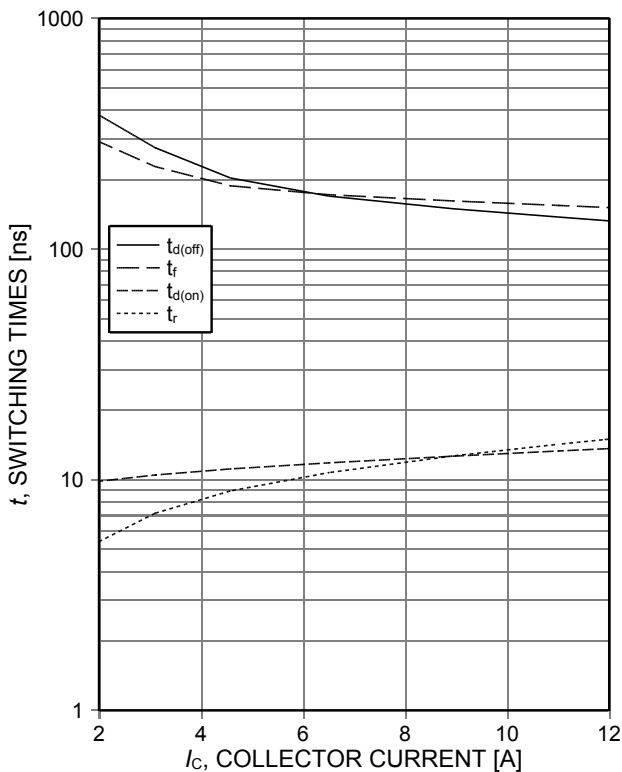

Figure 7. **Typical switching times as a function of collector current**  
(inductive load,  $T_{vj}=175^{\circ}C$ ,  $V_{CE}=400V$ ,  $V_{GE}=15/0V$ ,  $r_G=23\Omega$ , Dynamic test circuit in Figure E)

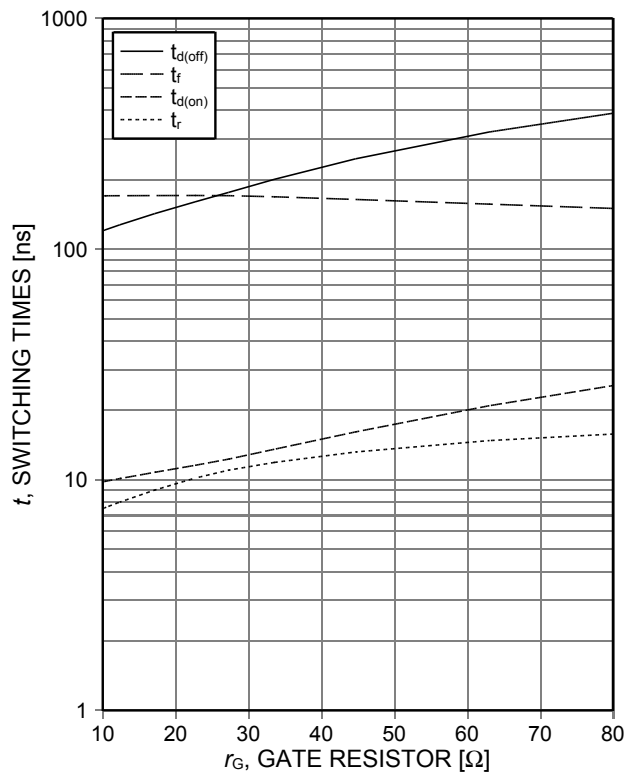

Figure 8. **Typical switching times as a function of gate resistor**  
(inductive load,  $T_{vj}=175^{\circ}C$ ,  $V_{CE}=400V$ ,  $V_{GE}=15/0V$ ,  $I_C=6A$ , Dynamic test circuit in Figure E)

TRENCHSTOP™ RC-Series for hard switching applications

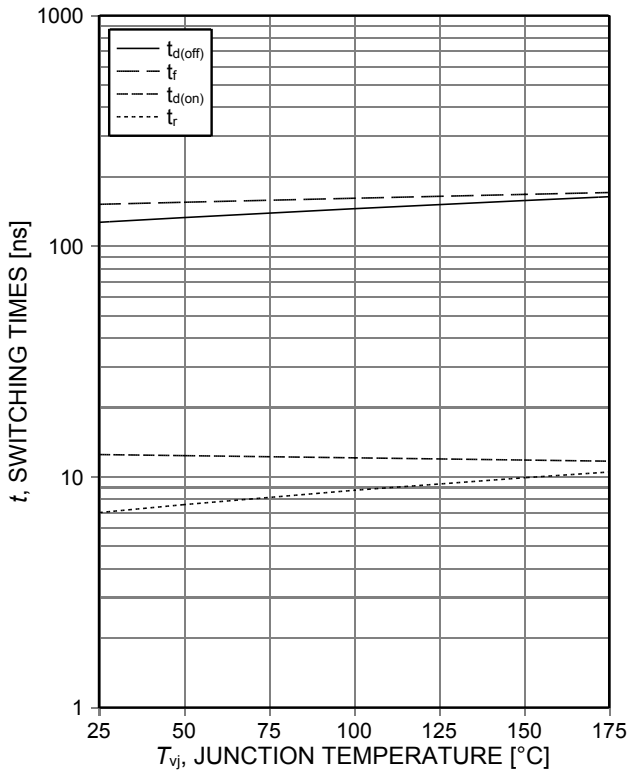

Figure 9. **Typical switching times as a function of junction temperature**  
 (inductive load,  $V_{CE}=400V$ ,  $V_{GE}=15/0V$ ,  $I_C=6A$ ,  $r_G=23\Omega$ , Dynamic test circuit in Figure E)

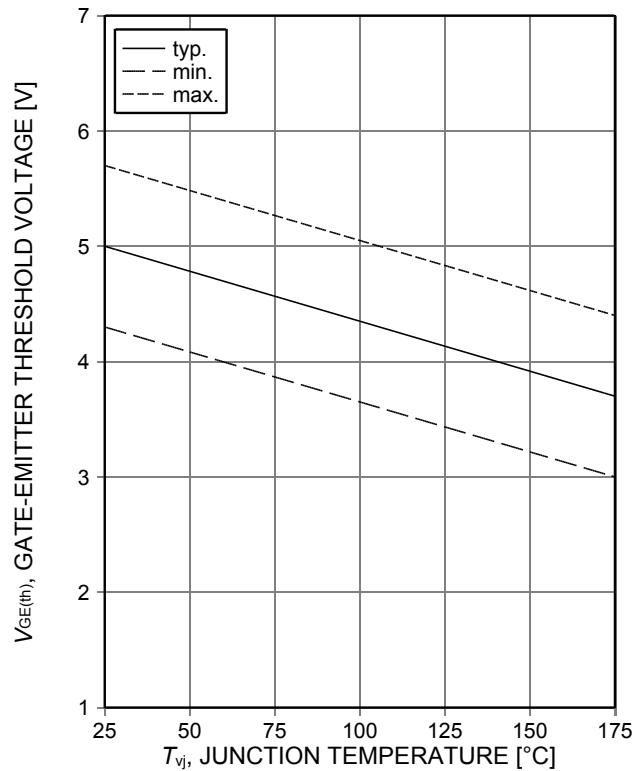

Figure 10. **Gate-emitter threshold voltage as a function of junction temperature**  
 ( $I_C=0.11mA$ )

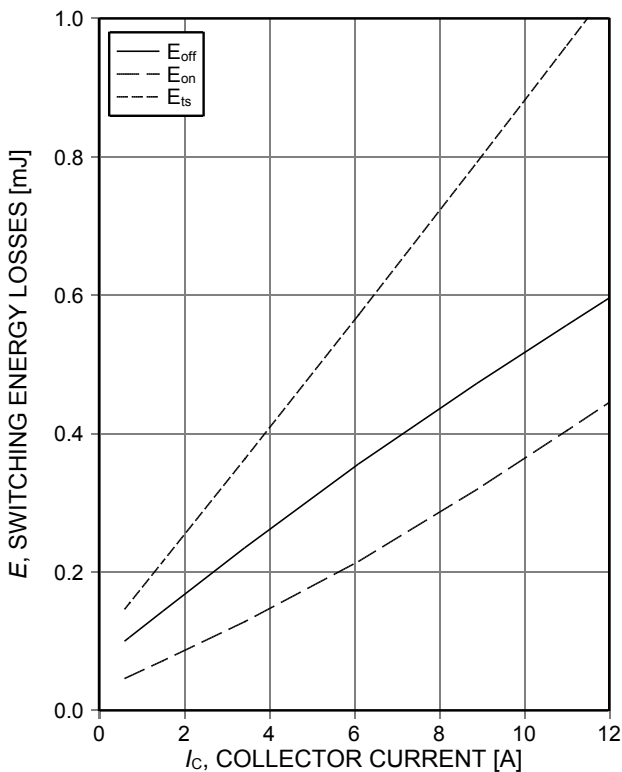

Figure 11. **Typical switching energy losses as a function of collector current**  
 (inductive load,  $T_{vj}=175^\circ C$ ,  $V_{CE}=400V$ ,  $V_{GE}=15/0V$ ,  $r_G=23\Omega$ , Dynamic test circuit in Figure E)

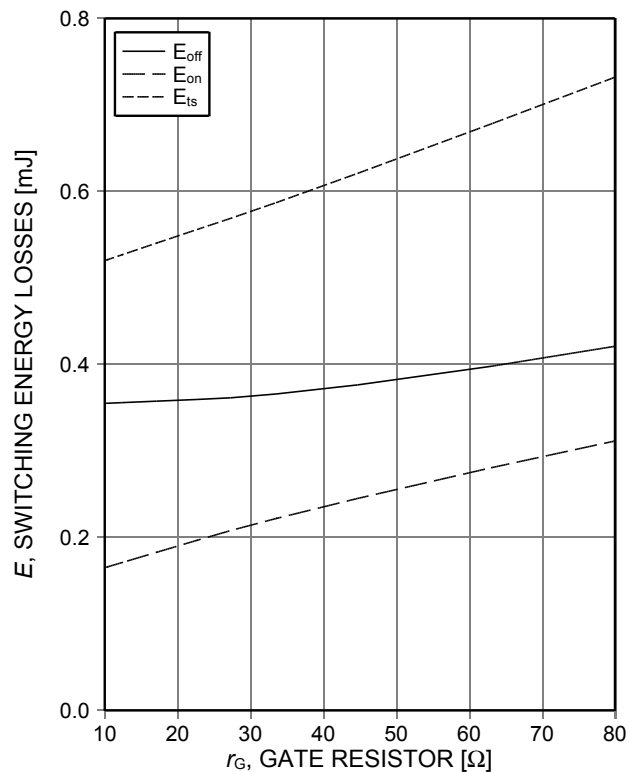

Figure 12. **Typical switching energy losses as a function of gate resistor**  
 (inductive load,  $T_{vj}=175^\circ C$ ,  $V_{CE}=400V$ ,  $V_{GE}=15/0V$ ,  $I_C=6A$ , Dynamic test circuit in Figure E)



TRENCHSTOP™ RC-Series for hard switching applications

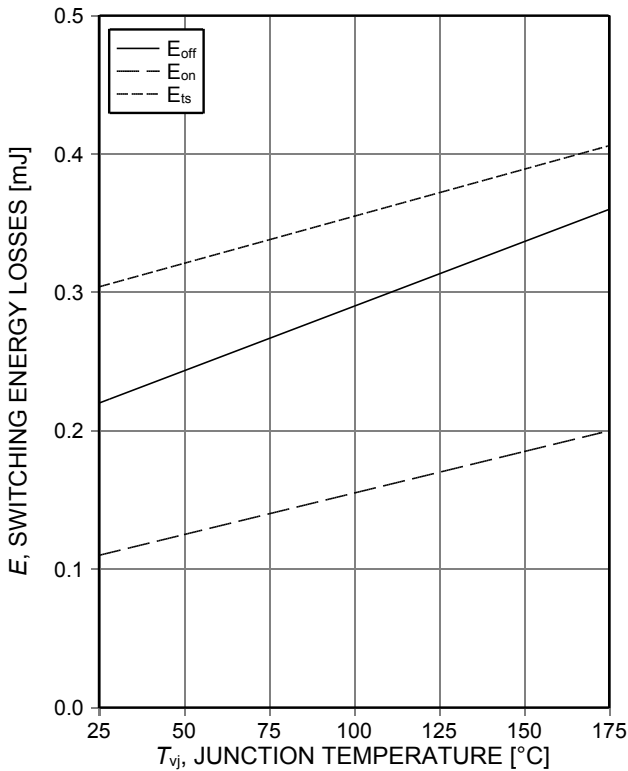

Figure 13. **Typical switching energy losses as a function of junction temperature** (inductive load,  $V_{CE}=400V$ ,  $V_{GE}=15/0V$ ,  $I_C=6A$ ,  $r_G=23\Omega$ , Dynamic test circuit in Figure E)

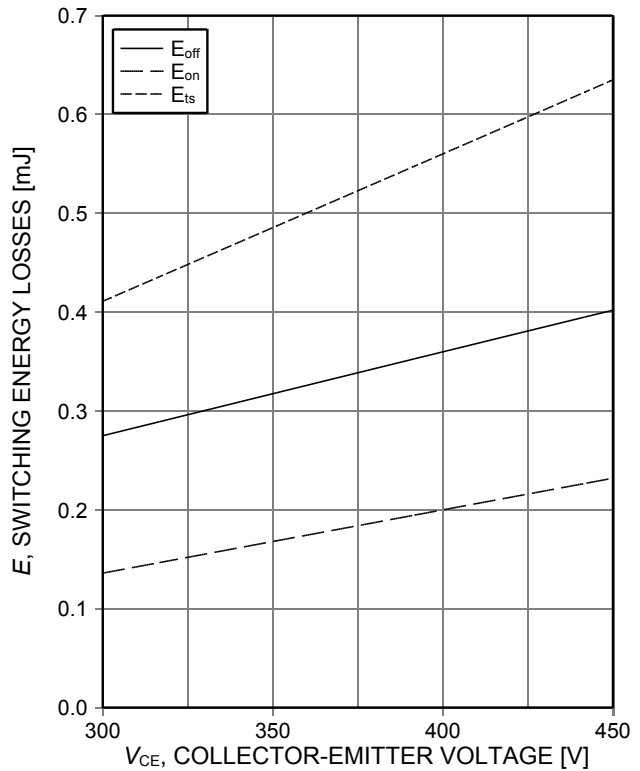

Figure 14. **Typical switching energy losses as a function of collector emitter voltage** (inductive load,  $T_{vj}=175^\circ C$ ,  $V_{GE}=15/0V$ ,  $I_C=6A$ ,  $r_G=23\Omega$ , Dynamic test circuit in Figure E)

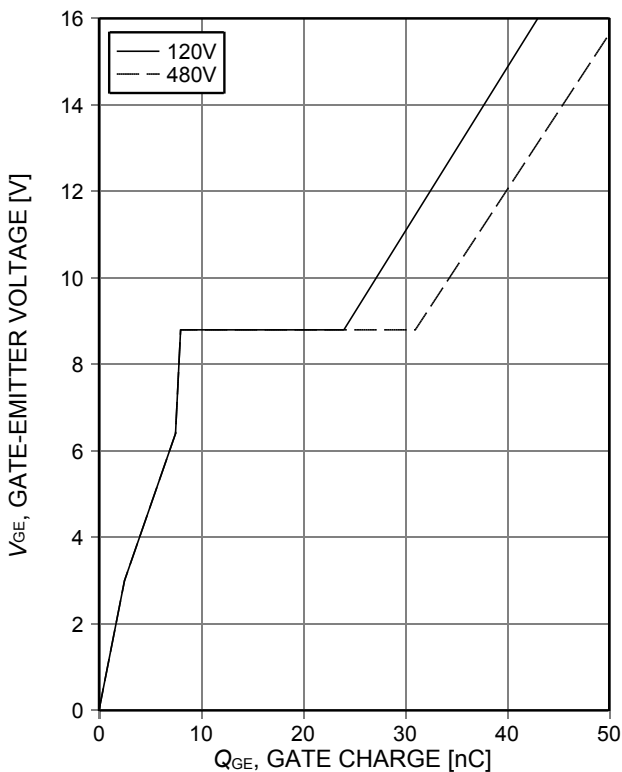

Figure 15. **Typical gate charge** ( $I_C=6A$ )

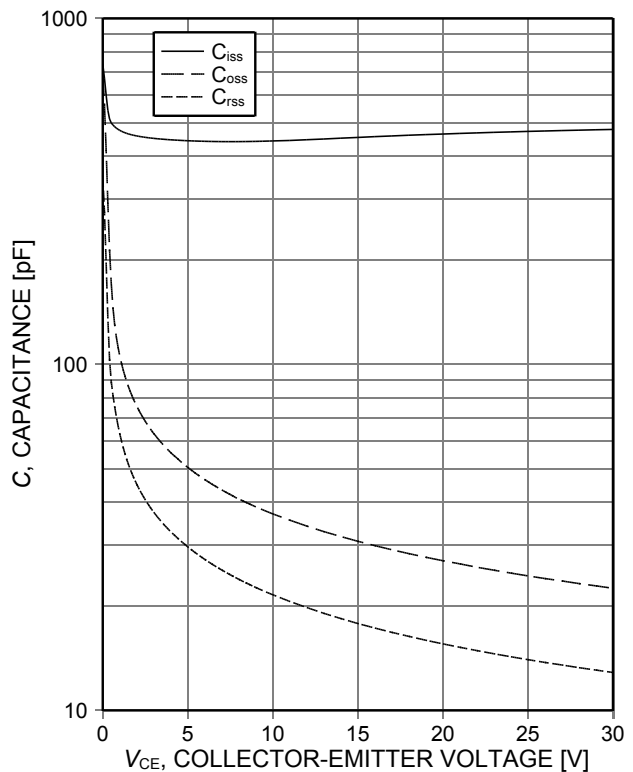

Figure 16. **Typical capacitance as a function of collector-emitter voltage** ( $V_{GE}=0V$ ,  $f=1MHz$ )

TRENCHSTOP™ RC-Series for hard switching applications

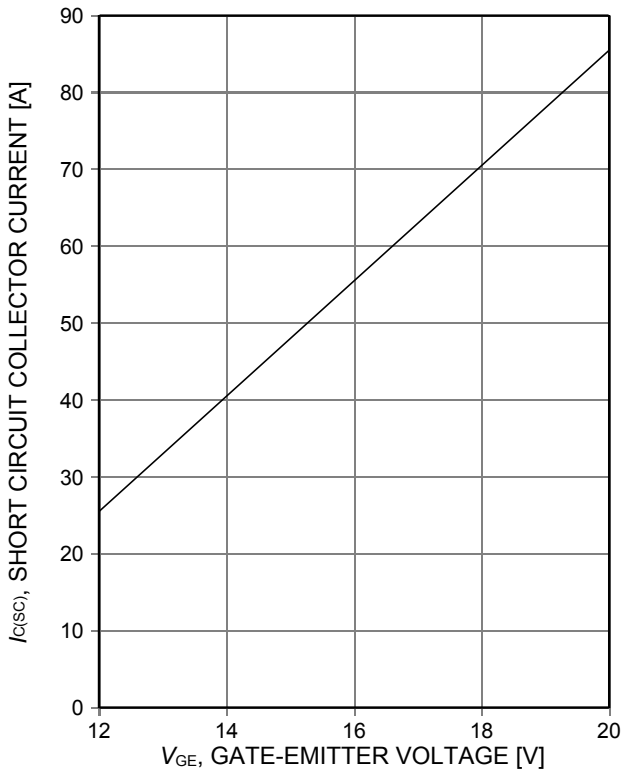

Figure 17. Typical short circuit collector current as a function of gate-emitter voltage (V<sub>CE</sub>≤400V, start at T<sub>vj</sub>=25°C)

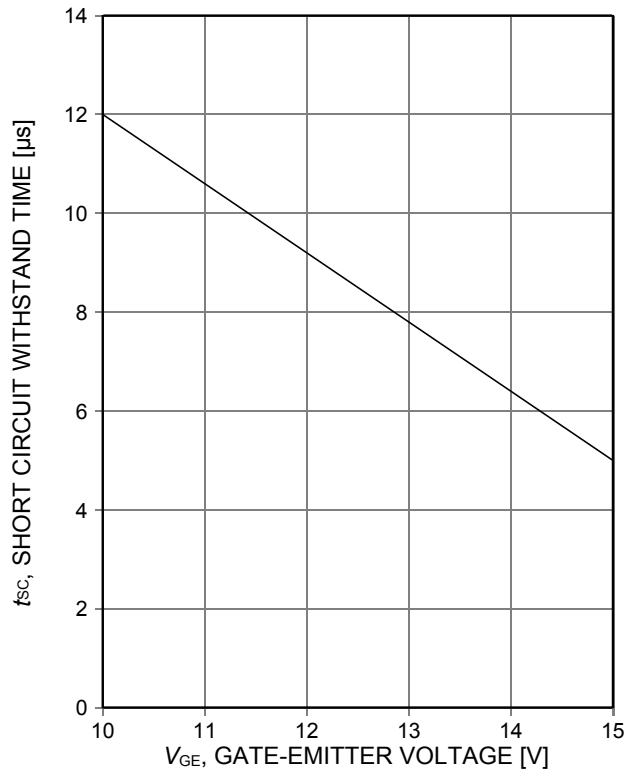

Figure 18. Short circuit withstand time as a function of gate-emitter voltage (V<sub>CE</sub>≤400V, start at T<sub>vj</sub>≤150°C)

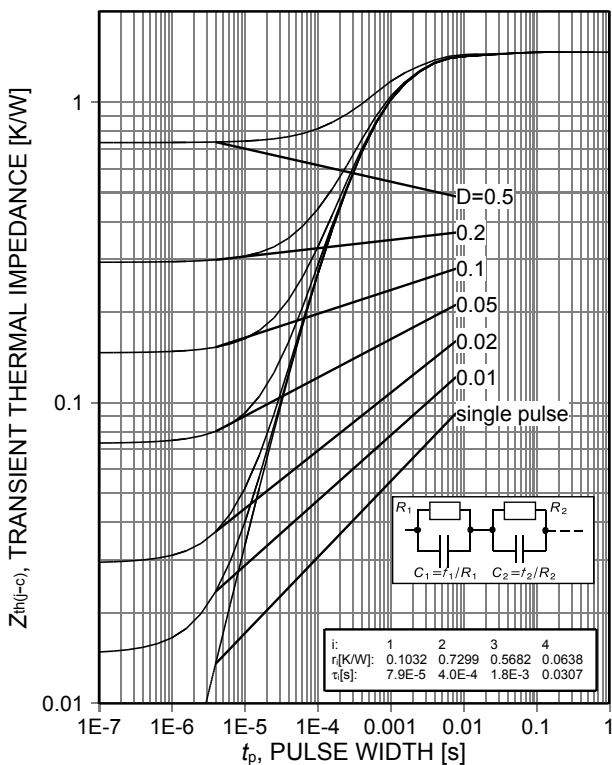

Figure 19. IGBT transient thermal impedance as a function of pulse width <sup>1)</sup> (see page 4) (D=t<sub>p</sub>/T)

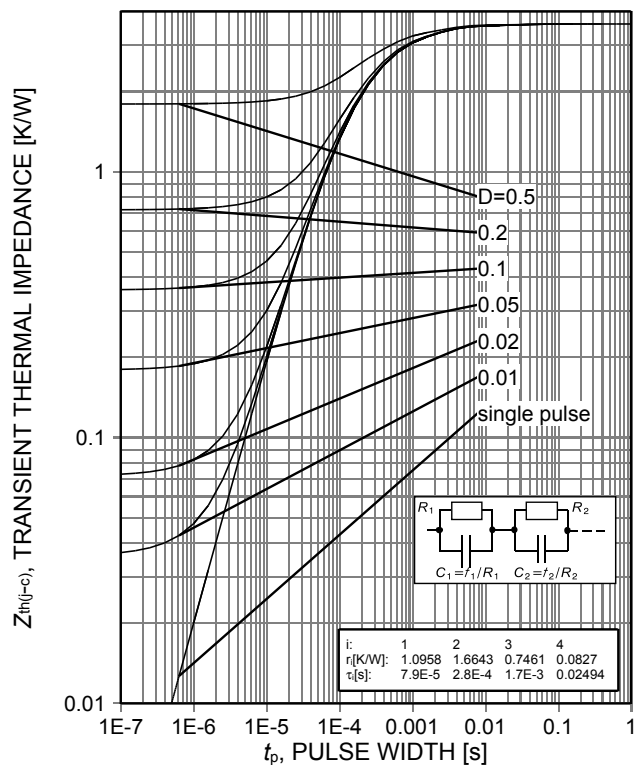

Figure 20. Diode transient thermal impedance as a function of pulse width <sup>2)</sup> (see page 4) (D=t<sub>p</sub>/T)

TRENCHSTOP™ RC-Series for hard switching applications

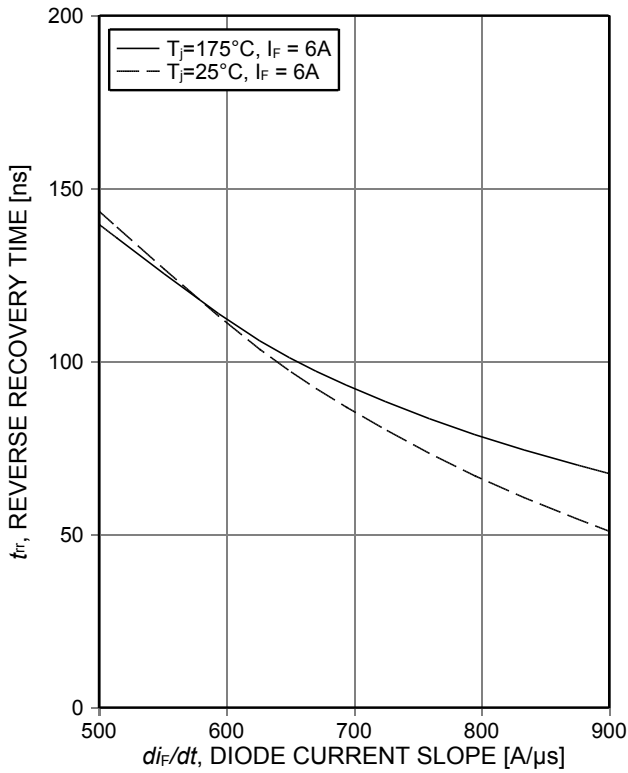

Figure 21. Typical reverse recovery time as a function of diode current slope ( $V_R=400V$ )

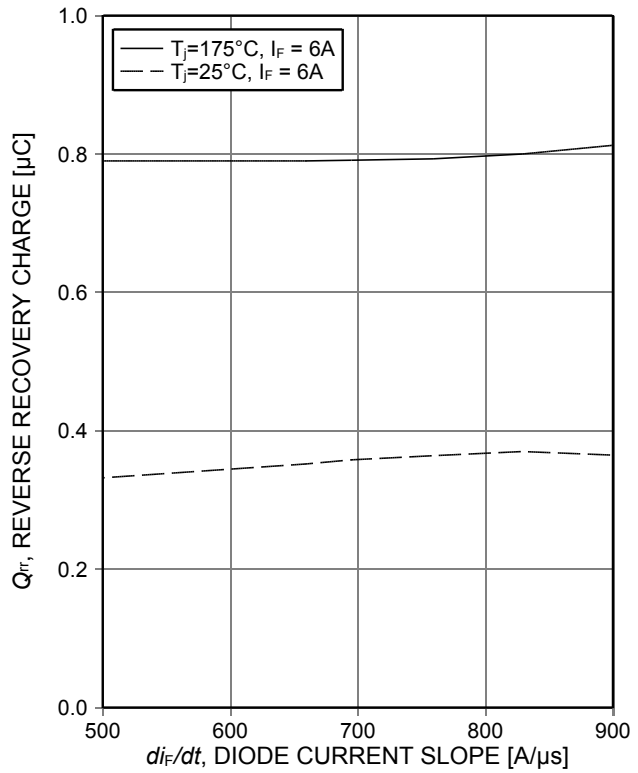

Figure 22. Typical reverse recovery charge as a function of diode current slope ( $V_R=400V$ )

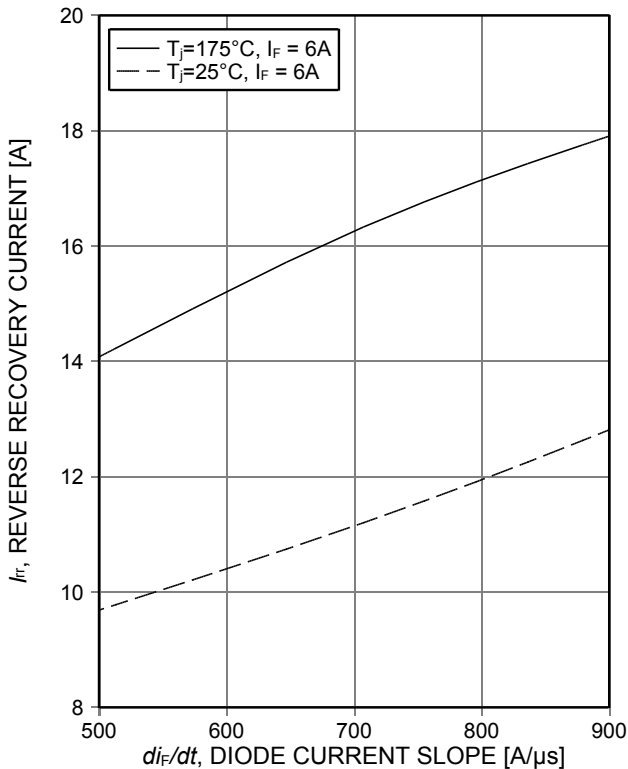

Figure 23. Typical reverse recovery current as a function of diode current slope ( $V_R=400V$ )

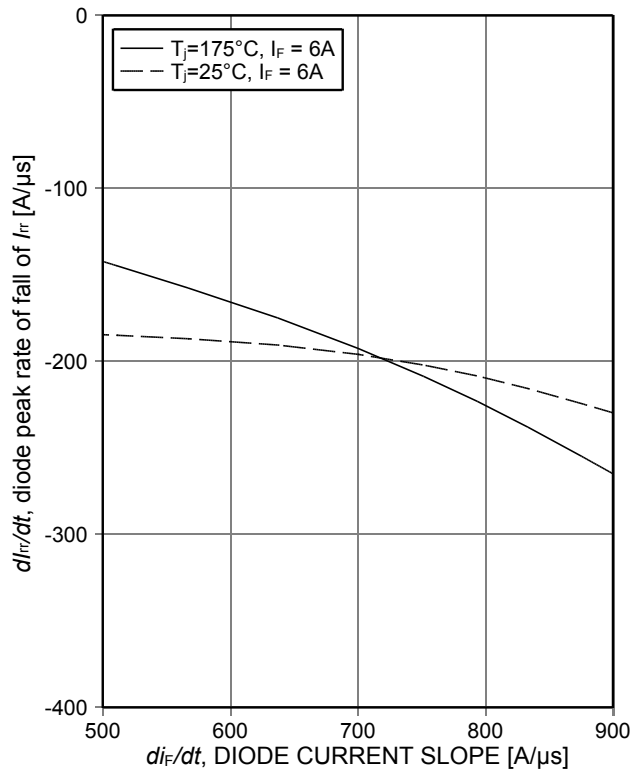

Figure 24. Typical diode peak rate of fall of reverse recovery current as a function of diode current slope ( $V_R=400V$ )

TRENCHSTOP™ RC-Series for hard switching applications

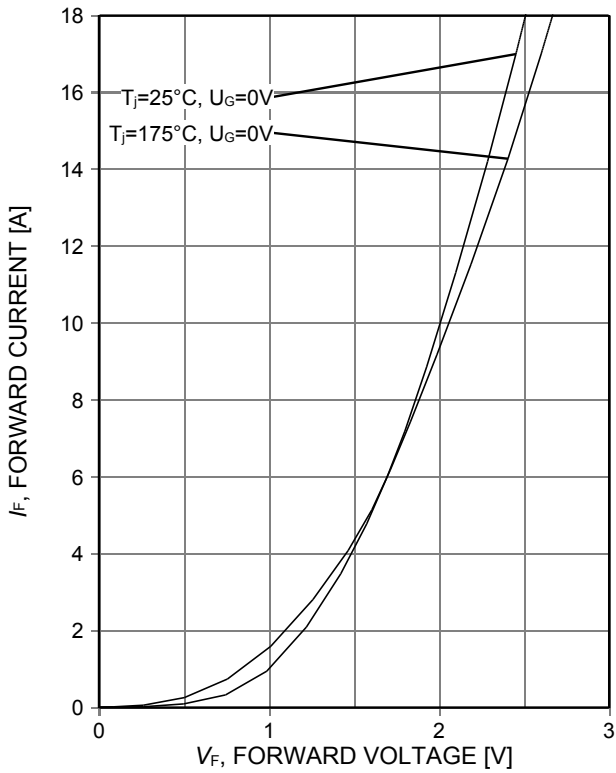

Figure 25. Typical diode forward current as a function of forward voltage

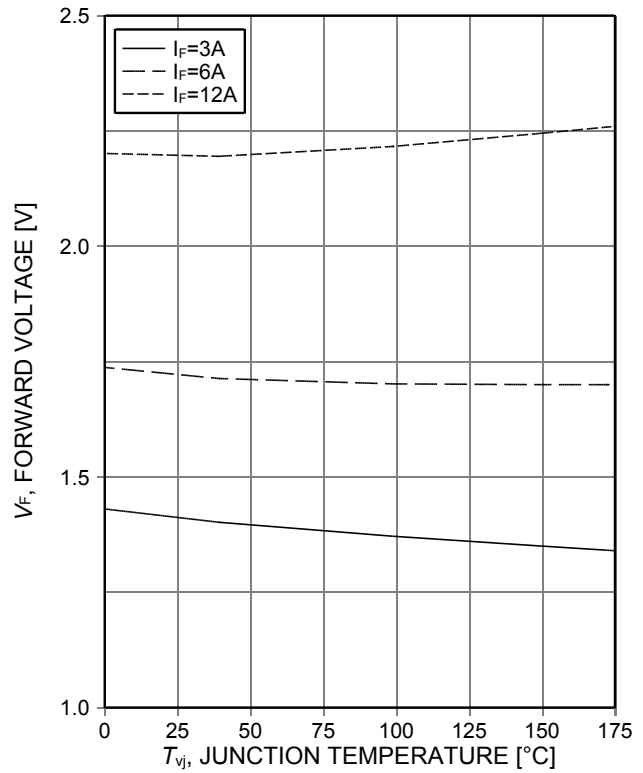
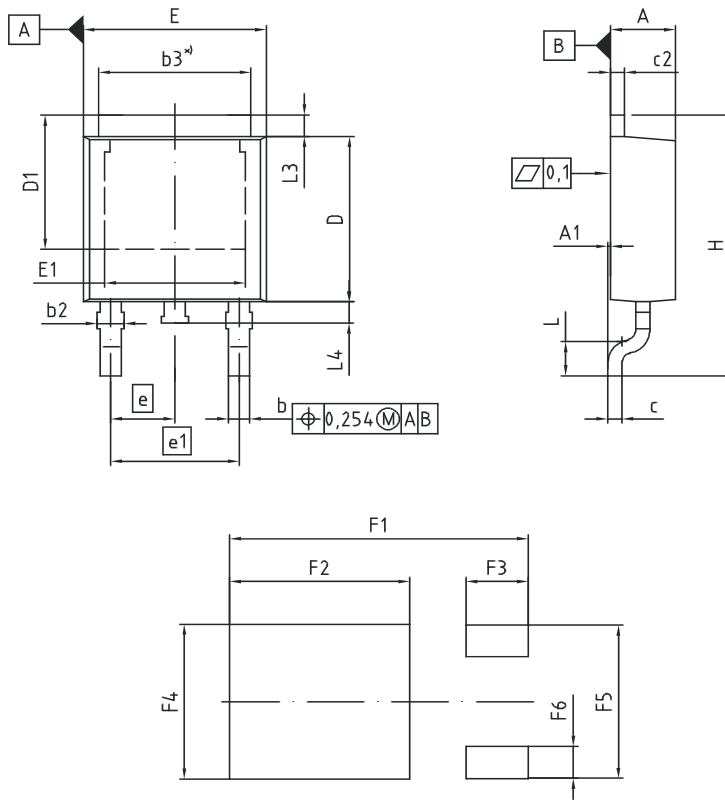

Figure 26. Typical diode forward voltage as a function of junction temperature

TRENCHSTOP™ RC-Series for hard switching applications

Package Drawing PG-TO252-3



\*) mold flash not included

| DIM | MILLIMETERS |       | INCHES      |       |
|-----|-------------|-------|-------------|-------|
|     | MIN         | MAX   | MIN         | MAX   |
| A   | 2.16        | 2.41  | 0.085       | 0.095 |
| A1  | 0.00        | 0.15  | 0.000       | 0.006 |
| b   | 0.64        | 0.89  | 0.025       | 0.035 |
| b2  | 0.65        | 1.15  | 0.026       | 0.045 |
| b3  | 5.00        | 5.50  | 0.197       | 0.217 |
| c   | 0.46        | 0.60  | 0.018       | 0.024 |
| c2  | 0.46        | 0.98  | 0.018       | 0.039 |
| D   | 5.97        | 6.22  | 0.235       | 0.245 |
| D1  | 5.02        | 5.84  | 0.198       | 0.230 |
| E   | 6.40        | 6.73  | 0.252       | 0.265 |
| E1  | 4.70        | 5.21  | 0.185       | 0.205 |
| e   | 2.29 (BSC)  |       | 0.090 (BSC) |       |
| e1  | 4.57        |       | 0.180       |       |
| N   | 3           |       | 3           |       |
| H   | 9.40        | 10.48 | 0.370       | 0.413 |
| L   | 1.18        | 1.70  | 0.046       | 0.067 |
| L3  | 0.90        | 1.25  | 0.035       | 0.049 |
| L4  | 0.51        | 1.00  | 0.020       | 0.039 |
| F1  | 10.60       |       | 0.417       |       |
| F2  | 6.40        |       | 0.252       |       |
| F3  | 2.20        |       | 0.087       |       |
| F4  | 5.80        |       | 0.228       |       |
| F5  | 5.76        |       | 0.227       |       |
| F6  | 1.20        |       | 0.047       |       |

**DOCUMENT NO.**  
Z8B00003328

**SCALE**

**EUROPEAN PROJECTION**

**ISSUE DATE**  
16-02-2011

**REVISION**  
04

Testing Conditions

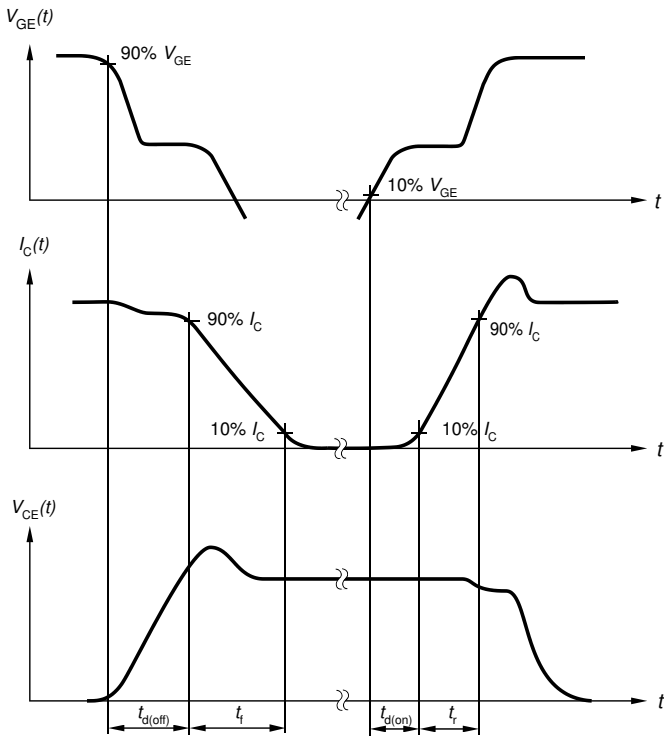

Figure A. Definition of switching times

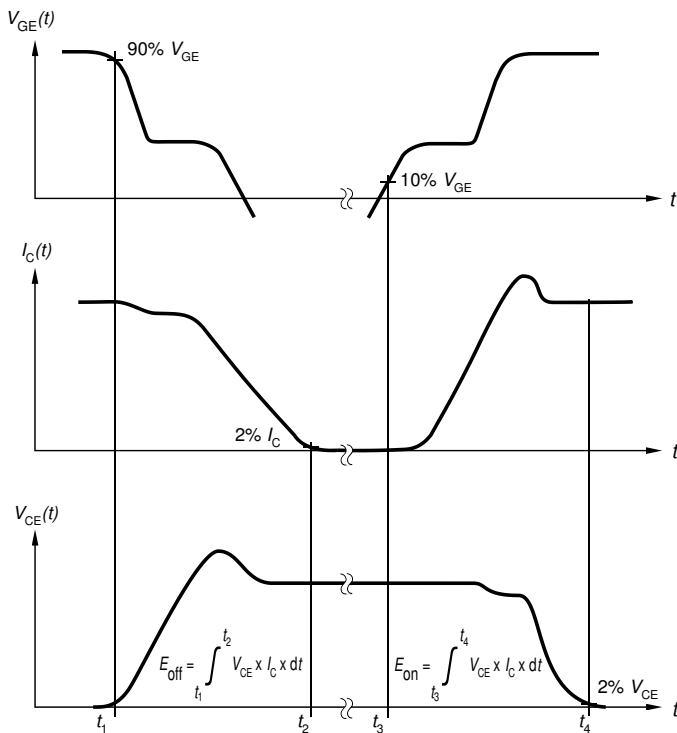

Figure B. Definition of switching losses

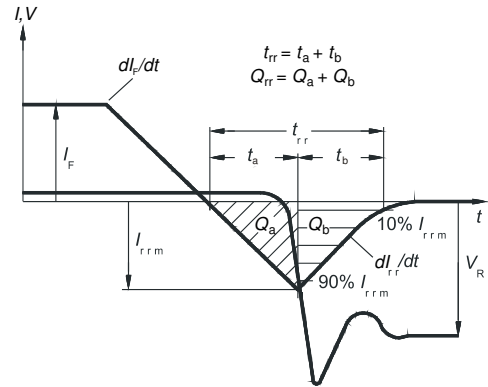

Figure C. Definition of diode switching characteristics

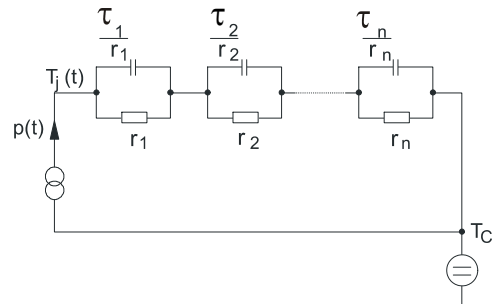

Figure D. Thermal equivalent circuit

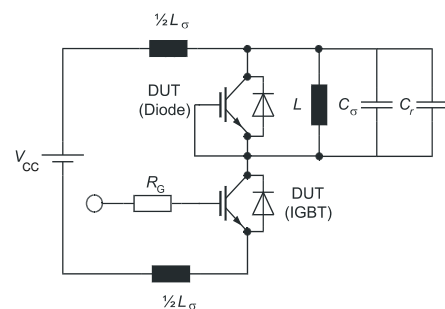

Figure E. Dynamic test circuit  
Parasitic inductance  $L_{\sigma}$ ,  
parasitic capacitor  $C_{\sigma}$ ,  
relief capacitor  $C_r$ ,  
(only for ZVT switching)

---

**TRENCHSTOP™ RC-Series for hard switching applications****Revision History**

---

AIHD06N60R

**Revision: 2017-02-09, Rev. 2.1**

---

Previous Revision

| Revision | Date       | Subjects (major changes since last revision) |
|----------|------------|--|
| 2.1      | 2017-02-09 | Data sheet created                           |

### **Trademarks of Infineon Technologies AG**

μHVIC™, μIPM™, μPFC™, AU-ConvertIR™, AURIX™, C166™, CanPAK™, CIPOS™, CIPURSE™, CoolDP™, CoolGaN™, COOLIR™, CoolMOS™, CoolSET™, CoolSiC™, DAVE™, DI-POL™, DirectFET™, DrBlade™, EasyPIM™, EconoBRIDGE™, EconoDUAL™, EconoPACK™, EconoPIM™, EiceDRIVER™, eupec™, FCOS™, GaNpowIR™, HEXFET™, HITFET™, HybridPACK™, iMOTION™, IRAM™, ISOFACE™, IsoPACK™, LEDriviR™, LITIX™, MIPAQ™, ModSTACK™, my-d™, NovalithIC™, OPTIGA™, OptiMOS™, ORIGA™, PowIRaudio™, PowIRstage™, PrimePACK™, PrimeSTACK™, PROFET™, PRO-SIL™, RASIC™, REAL3™, SmartLEWIS™, SOLID FLASH™, SPOC™, StrongIRFET™, SupIRBuck™, TEMPFET™, TRENCHSTOP™, TriCore™, UHVIC™, XHP™, XMC™

Trademarks updated November 2015

### **Other Trademarks**

All referenced product or service names and trademarks are the property of their respective owners.

**Published by**  
**Infineon Technologies AG**  
**81726 München, Germany**  
**© Infineon Technologies AG 2017.**  
**All Rights Reserved.**

### **Important Notice**

The information given in this document shall in no event be regarded as a guarantee of conditions or characteristics ("Beschaffenheitsgarantie"). With respect to any examples, hints or any typical values stated herein and/or any information regarding the application of the product, Infineon Technologies hereby disclaims any and all warranties and liabilities of any kind, including without limitation warranties of non-infringement of intellectual property rights of any third party.

In addition, any information given in this document is subject to customer's compliance with its obligations stated in this document and any applicable legal requirements, norms and standards concerning customer's products and any use of the product of Infineon Technologies in customer's applications.

The data contained in this document is exclusively intended for technically trained staff. It is the responsibility of customer's technical departments to evaluate the suitability of the product for the intended application and the completeness of the product information given in this document with respect to such application.

For further information on the product, technology, delivery terms and conditions and prices please contact your nearest Infineon Technologies office ([www.infineon.com](http://www.infineon.com)).

### **Warnings**

Due to technical requirements products may contain dangerous substances. For information on the types in question please contact your nearest Infineon Technologies office.

Except as otherwise explicitly approved by Infineon Technologies in a written document signed by authorized representatives of Infineon Technologies, Infineon Technologies' products may not be used in any applications where a failure of the product or any consequences of the use thereof can reasonably be expected to result in personal injury.