

42 SERIES

5A HIGH CURRENT ▲ Si MOSFET RELAY

SILICON Si MOSFET RELAY ▲ DIP and SMD type
 Up to 5000mA ▲ Switches AC or DC load
 One channel and two channel packages available
 Input TTL / CMOS compatible
 Moisture Sensitivity Level ▲ MSL 1
UL 1577 approved ▲ File no E344988

SPECIFICATION

Item	Characteristics	
Contact Form	1 Form A / 2 Form A ▲ Normally open switch	
Load Voltage	V_L	60V
Operation LED Current	$I_{F ON}$	3mA
Load Current	I_L	5000mA
On-Resistance	R_{ON}	0.02Ω
Output Capacitance	C_{OUT}	1300pF
Low Off-State Leakage Current	I_{LEAK}	1μA at 60V _{DC}

APPLICATIONS

Automatic Test Equipment	I/O Modules	Industrial Automation	Measurement Equipment	Security Equipment	Sensing Equipment	Telecom Equipment

DIMENSIONS

Package	Illustration	Dimensions	PCB Board Pattern
DIP-4			<p style="text-align: right;">BOTTOM VIEW</p>
SMD-4			<p style="text-align: right;">TOP VIEW</p>

DIMENSIONS

Package	Illustration	Dimensions	PCB Board Pattern
DIP-6			<p style="text-align: right;">BOTTOM VIEW</p>
SMD-6			<p style="text-align: right;">TOP VIEW</p>
DIP-8			<p style="text-align: right;">BOTTOM VIEW</p>
SMD-8			<p style="text-align: right;">TOP VIEW</p>
SOP-4			<p style="text-align: right;">TOP VIEW</p>
SOP-8			<p style="text-align: right;">TOP VIEW</p>

ABSOLUTE MAXIMUM RATINGS ▲ AMBIENT TEMPERATURE $T_A = 25^\circ\text{C}$

Type	Item	Condition	Symbol	Value					Unit
				SOP-4	SOP-8	DIP-4 SMD-4	DIP-8 SMD-8	DIP-6 SMD-6	
Type	Outline package			SOP-4	SOP-8	DIP-4 SMD-4	DIP-8 SMD-8	DIP-6 SMD-6	
	Part number			AB42S	AC42S	AB42(F)	AC42(F)	AA42(F)	
	Output channels			1	2	1	2	1	Channels
Input	Continuous LED Current		I_F	50					mA
	Peak LED Current	100 Hz, Duty 1%	I_{FP}	500					mA
	LED Reverse Voltage		V_R	5					V
	Input Power Dissipation		P_{IN}	75					mW
Output	Load Voltage		V_L	60 (AC peak or DC)					V
	Load Current		I_L	2500	2000	2500	2000	5000	mA
	Peak Load Current	1 ms, 1 shot	I_{PEAK}	6000	6000	6000	6000	14000	mA
	Output Power Dissipation		P_{OUT}	400	450	400	450	800	mW
Relay	Total Power Dissipation		P_T	450	500	450	500	850	mW
	I/O Breakdown Voltage		$V_{I/O}$	1500	1500	3750	3750	3750	V_{RMS}
	I/O Breakdown Voltage (Suffix-H)		$V_{I/O}$	3750	3750	5000	5000	5000	V_{RMS}
	Operating Temperature Range		T_{OPR}	-40 to +85					$^\circ\text{C}$
	Storage Temperature Range		T_{STG}	-40 to +100					$^\circ\text{C}$

ELECTRICAL CHARACTERISTICS ▲ AMBIENT TEMPERATURE $T_A = 25^\circ\text{C}$

Type	Item	Condition	Symbol	Min.	Typ.	Max.	Unit
Input	LED Forward Voltage	$I_F = 10\text{mA}$	V_F	1	1.37	1.5	V
	Operation LED Current		I_{FON}		1 1.7 (DIP6)	5	mA
	Recovery LED Voltage		V_{FOFF}	0.5	1.2		V
Output	On-Resistance				0.053	0.064	Ω
	Drain to Drain (tested within 1 sec.)	$I_F=5\text{mA}, I_L=\text{Rating}$	R_{ON}		0.02 (DIP6)	0.032 (DIP6)	
	Off-State Leakage Current	$V_L = 60\text{V}$	I_{LEAK}			1	μA
	Output Capacitance	$V_L=0\text{V}, f=1\text{MHz}$	C_{OUT}		400 1300 (DIP6)		pF
Transmission	Turn-On Time (for SOP/DIP4,8 type)	$I_F=5\text{mA}, I_L=\text{Rating}$	t_{ON}		0.8	3	ms
	Turn-Off Time (for SOP/DIP4,8 type)	$I_F=5\text{mA}, I_L=\text{Rating}$	t_{OFF}		0.15	0.5	ms
	Turn-On Time (for DIP6 type)	$I_F=10\text{mA}, I_L=\text{Rating}$	t_{ON}		1.2	3	ms
	Turn-Off Time (for DIP6 type)	$I_F=10\text{mA}, I_L=\text{Rating}$	t_{OFF}		0.15	0.5	ms
Coupled	I/O Insulation Resistance		$R_{I/O}$	10^9			Ω
	I/O Capacitance	$f=1\text{MHz}$	$C_{I/O}$		1.3		pF

REFERENCE DATA ▲ DIP-4/DIP-6/DIP-8/SMD-4/SMD-6/SMD-8

Load current vs. ambient temp.

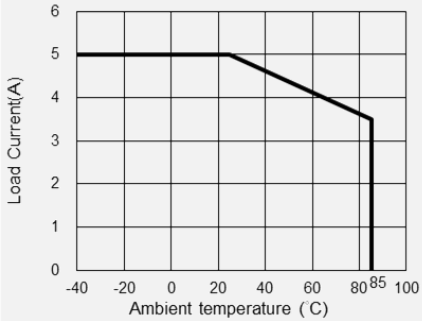

On resistance vs. ambient temp.

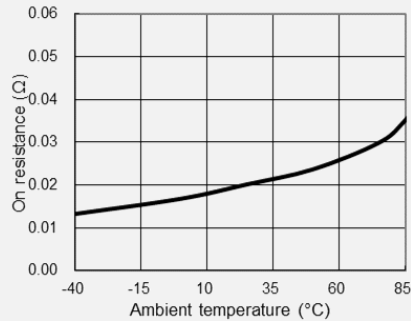

Turn on time vs. ambient temp.

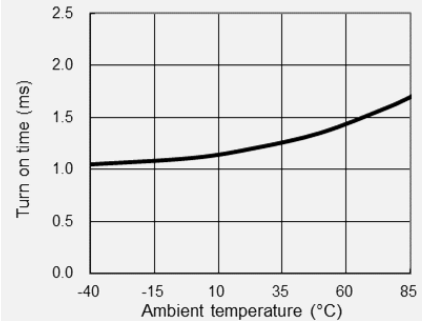

Turn off time vs. ambient temp.

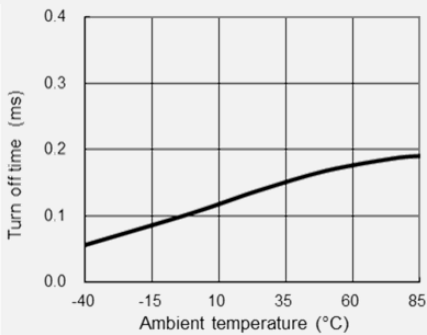

LED operate current vs. ambient temp

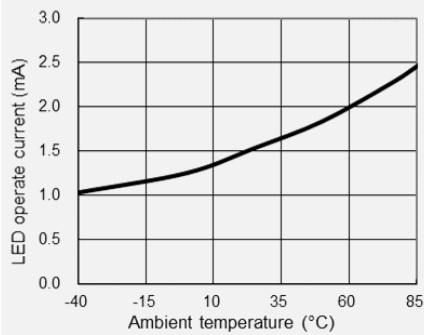

LED turn off current vs. ambient temp.

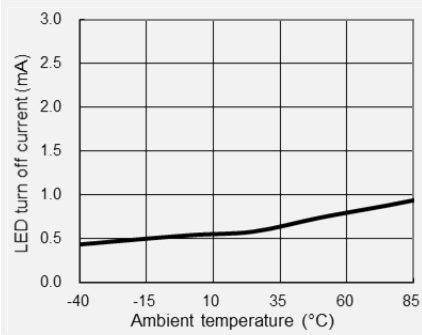

Load forward voltage vs. ambient temp.

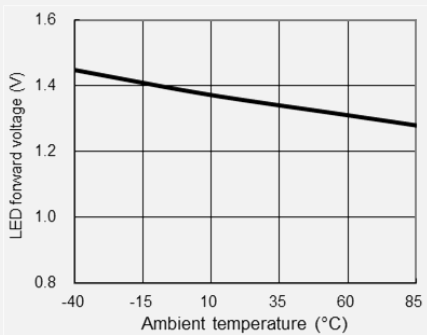

Current vs. voltage characteristics of output at MOS portion

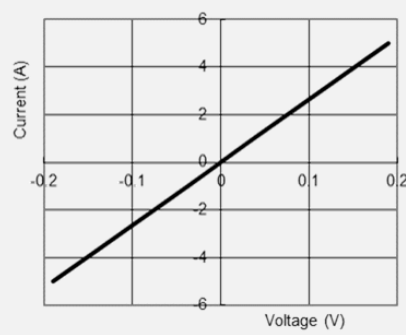

Off state leakage current vs. load voltage

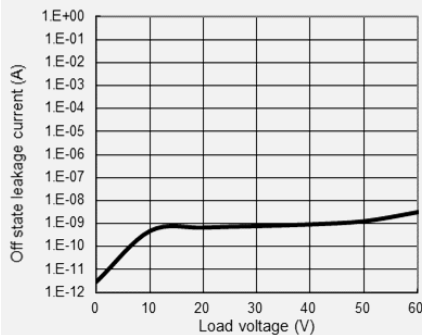

Turn on time vs. LED forward current

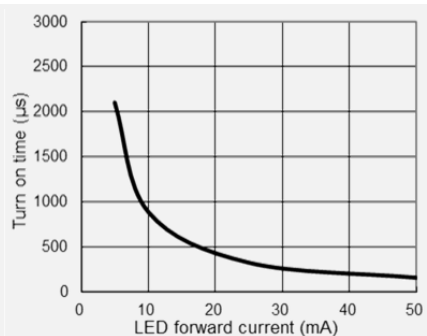

Turn off time vs. LED forward current

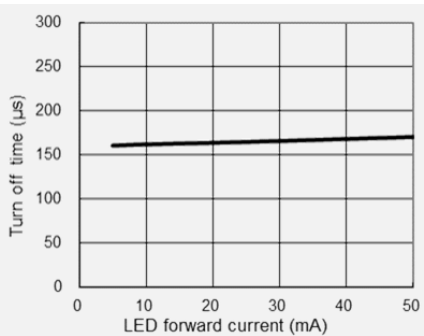

Output capacitance vs. applied voltage

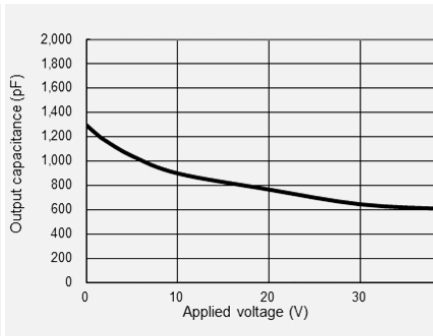

PIN DESCRIPTION AND PART NUMBER

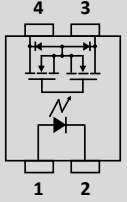
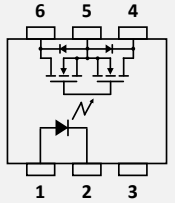
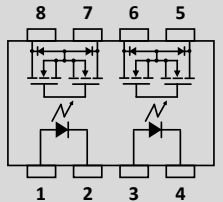
Circuit Diagram	Pin Description	Part No.	Package	Packing
	1 Anode (+) ▪ LED 2 Cathode (-) ▪ LED 3,4 Drain ▪ MOSFET	AB42 AB42F AB42S AB42F-R1 AB45S-R1	DIP-4 SMD-4 SOP-4 SMD-4 SOP-4	Tube (90pcs) Tube (90pcs) Tube (100pcs) Reel (1 000pcs) Reel (1 000pcs)
	1 Anode (+) ▪ LED 2 Cathode (-) ▪ LED 3 NC 4,6 Drain ▪ MOSFET 5 Source ▪ MOSFET	AA42 AA42F AA42F-R1	DIP-6 SMD-6 SMD-6	Tube (50pcs) Tube (50pcs) Reel (1 000pcs)
	1,3 Anode (+) ▪ LED 2,4 Cathode (-) ▪ LED 5,6,7,8 Drain ▪ MOSFET	AC42 AC42F AC42S AC42F-R1 AC42S-R1	DIP-8 SMD-8 SOP-8 SMD-8 SOP-8	Tube (45pcs) Tube (45pcs) Tube (50pcs) Reel (1 000pcs) Reel (1 000pcs)

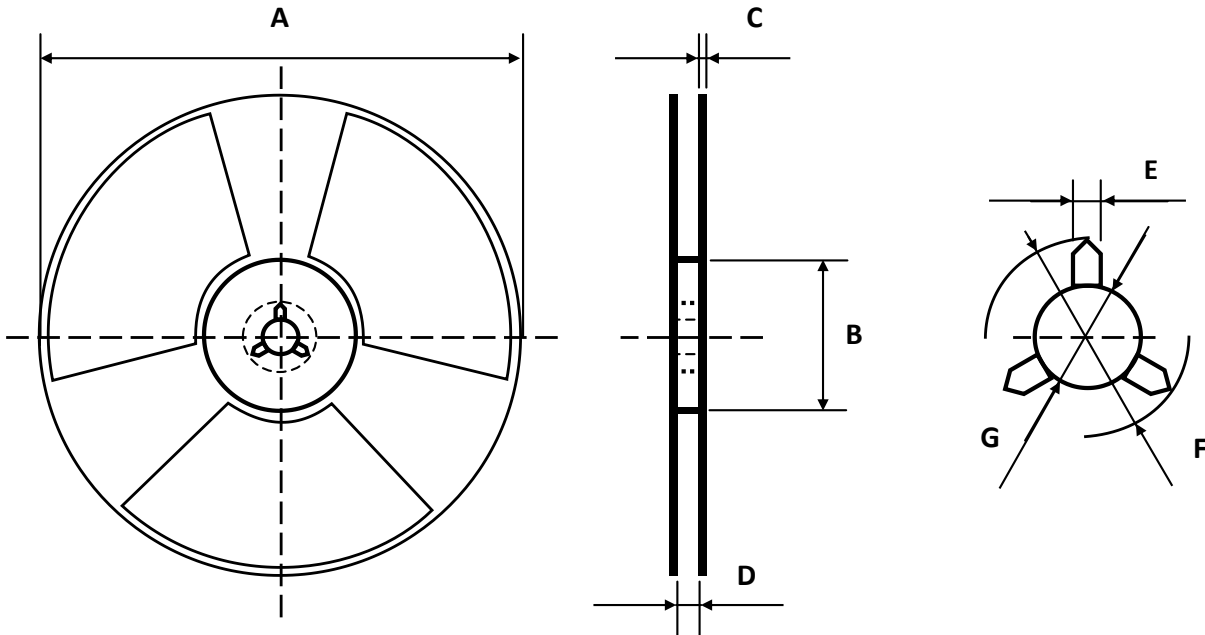
REEL DIMENSIONS ▲ All dimensions in mm

Size	A	B	C	D	E	F	G
SOP-4	330	100	2	13	2	13	21
SOP-8	330	100	2	17	2	13	21
SMD-4	380	80	2.2	17	2	13	21
SMD-6	380	80	2.2	17	2	13	21
SMD-8	380	80	2.2	17	2	13	21

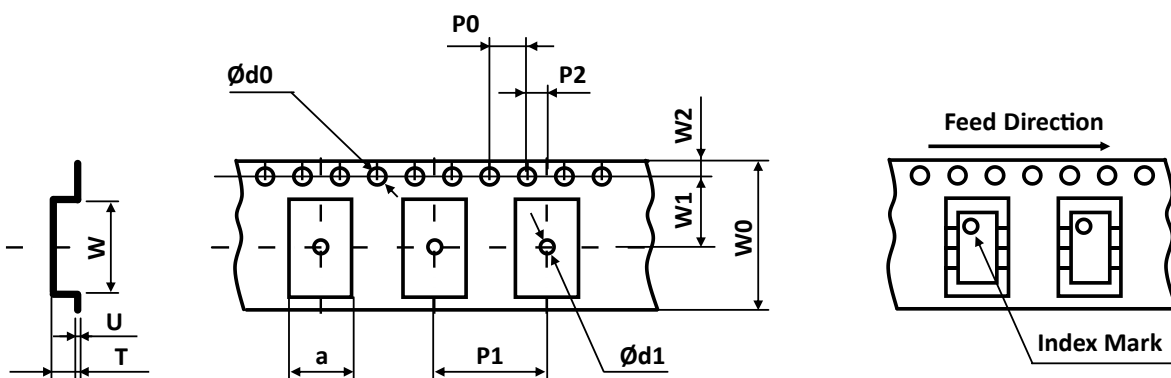
TAPE DIMENSIONS ▲ All dimensions in mm

Size	W	U	T	a	Ød0	Ød1	P0	P1	P2	W0	W1	W2
SOP-4	4.6	0.3	2.3	7.2	1.5	1.5	4	12	2	12	7.5	1.75
SOP-8	10.4	0.3	2.3	7.5	1.5	1.5	4	12	2	16	7.5	1.75
SMD-4	5.3	0.3	4	10.6	1.5	1.5	4	16	2	16	7.5	1.75
SMD-6	9.15	0.3	4.45	10.4	1.5	1.5	4	16	2	16	11.5	1.75
SMD-8	9.9	0.3	4	10.6	1.5	1.5	4	16	2	16	7.5	1.75

PACKING QUANTITIES

Tape and Reel Packing	PCS/Reel
SMD-4	1000
SMD-6	1000
SMD-8	1000
SOP-4	1000
SOP-8	1000

Tube Packing	PCS/Tube	Tubes/Box	Units/Box
DIP-4	90	30	2700
DIP-6	50	30	1500
DIP-8	45	30	1350
SMD-4	90	30	2700
SMD-6	50	30	1500
SMD-8	45	30	1350
SOP-4	100	30	3000
SOP-8	50	30	1500

STORAGE AND HANDLING CONDITIONS

ESD level	Floor life	Conditions	MSL
HBM class 2	Unlimited	$T_A < 30^\circ\text{C}$, RH < 85%	1

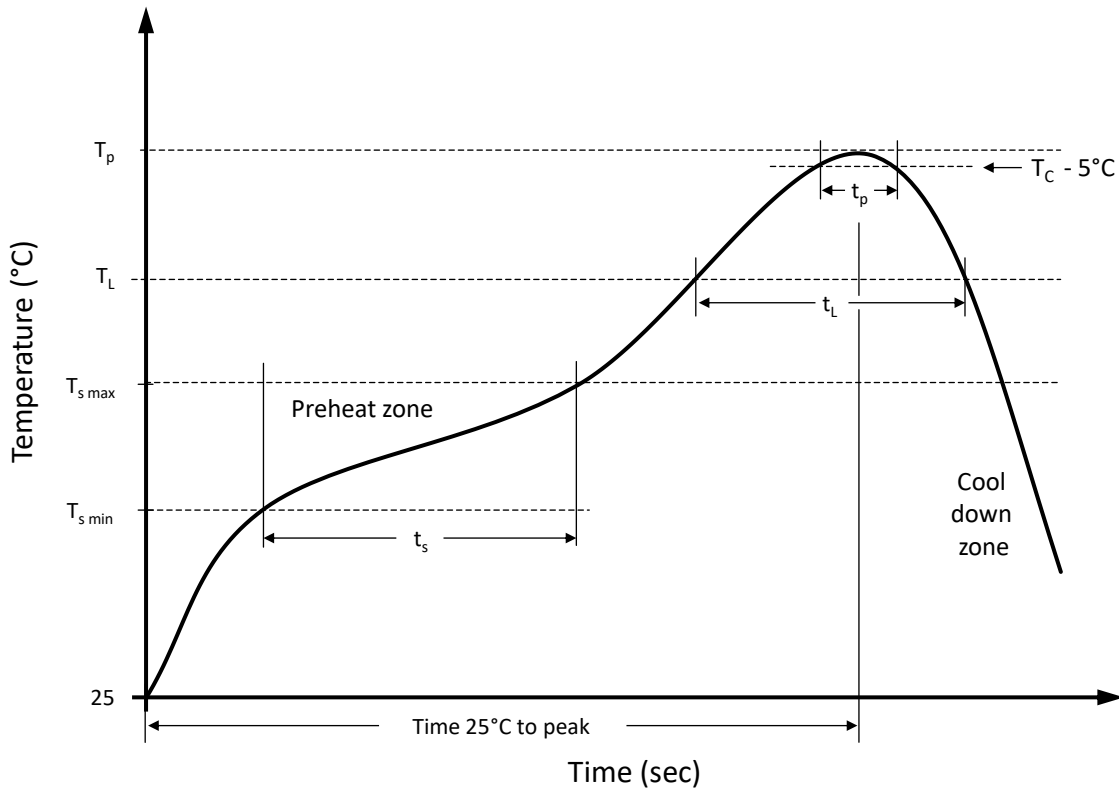
RECOMMENDED REFLOW SOLDERING PROFILE ▲ SMD PACKAGE

Recommended reflow soldering conditions ▲ Refer to JEDEC J-STD-020E

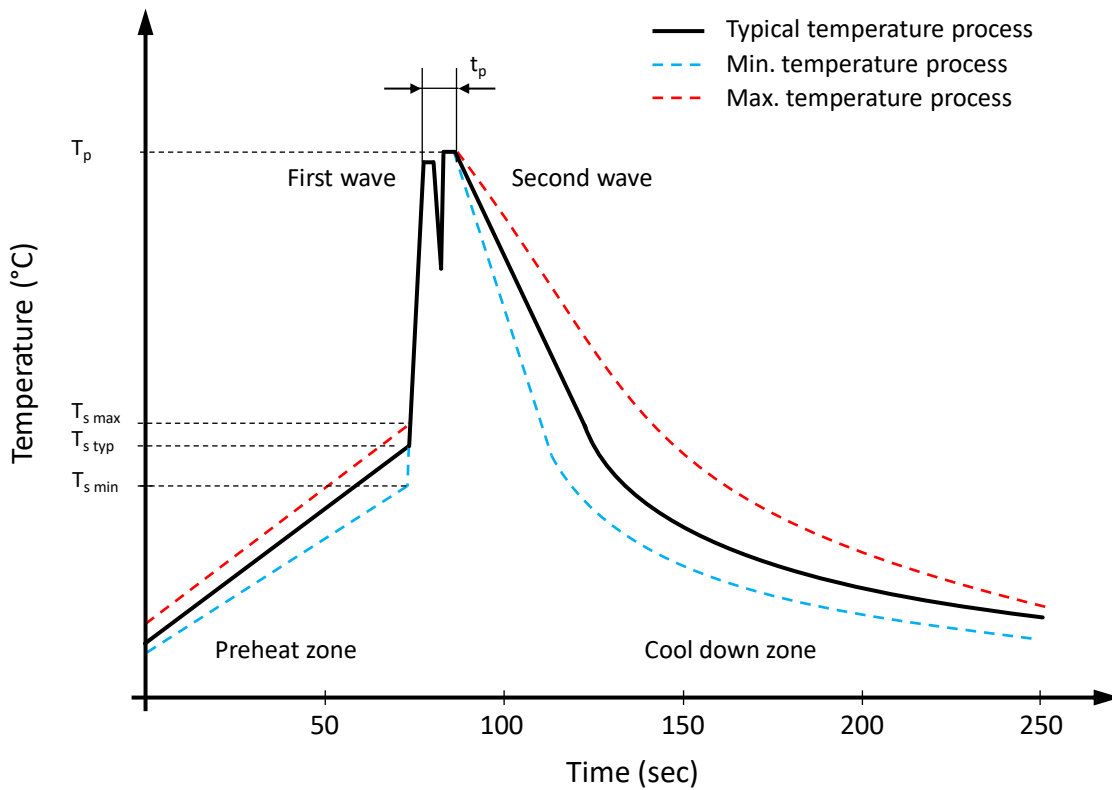
Profile Features		Sn-Pb Eutetic Assembly	Pb-Free Assembly
Preheat temperature min.	$T_{s\ min}$	100 °C	150 °C
Preheat temperature max.	$T_{s\ max}$	150 °C	200 °C
Preheat time t_s from $T_{s\ min}$ to $T_{s\ max}$	t_s	120 seconds	120 seconds
Ramp-up rate (T_L to T_p)		max. 3 °C/second	max. 3 °C/second
Liquidous temperature	T_L	183 °C	217 °C
Time t_L maintained above T_L	t_L	150 seconds max.	60 seconds max.
Peak package body temperature	T_p	235°C	260°C
Timeframe of within 5°C below and up to max actual peak body temperature	t_p	20 seconds max.	30 seconds max.
Ramp-down rate (T_L to T_p)		max. 6 °C/second	max. 6 °C/second
Time 25°C to peak temperature		max. 6 minutes	max. 8 minutes

RECOMMENDED WAVE SOLDERING PROFILE ▲ THT PACKAGE

Classification wave soldering profile ▲ Refer to EN 61760-1: 2006

Profile Features		Value ▲ Sn-Pb Assembly	Value ▲ Pb-free Assembly
Preheat temperature min.	$T_{s\ min}$	100 °C	100 °C
Preheat temperature typical	$T_{s\ typ}$	120 °C	120 °C
Preheat temperature max.	$T_{s\ max}$	130 °C	130 °C
Preheat time t_s from $T_{s\ min}$ to $T_{s\ max}$	t_s	70 seconds	70 seconds
Peak temperature	T_p	235 °C to 260 °C	245 °C to 260 °C
Time of actual peak temperature	t_p	Max. 10 seconds Max. 5 second each wave	Max. 10 seconds Max. 5 second each wave
Ramp-down rate min.		~ 2 °C/second	~ 2 °C/second
Ramp-down rate typical		~ 3.5 °C/second	~ 3.5 °C/second
Ramp-down rate max.		~ 5 °C/second	~ 5 °C/second
Time 25°C to 25°C		4 minutes	4 minutes

LOAD CONNECTING METHOD

Type	Load	Connection	Feature
4 pins	AC or DC		Control bi-directional signal
6 pins	A		Control bi-directional signal
	B		On-resistance is 1/2 of A-connection 2-Make-contacts (Source Common)
C		On-Resistance is 1/2 of B-connection	
8 pins	AC or DC		2 input and 2 output
			1 input and 2 output

PRODUCT CODE

Example: AC42F series ▲ 2 Form A ▲ 60V ▲ SMD-8 ▲ Tape & Reel

AC		42		-		F		R1	
Package		Series		Special Suffix		Type		Packing	
AA	6 Pin ▲ 1 Form A	42	60V	Blank H	Standard High Insulation	Blank F S	DIP SMD SOP	Blank R1	Tube Reel
AB	4 Pin ▲ 1 Form A								
AC	8 Pin ▲ 2 Form A								

PRODUCT MARKING

Example: AC42F series ▲ 2 Form A ▲ 60V ▲ SMD-8 ▲ Tape & Reel

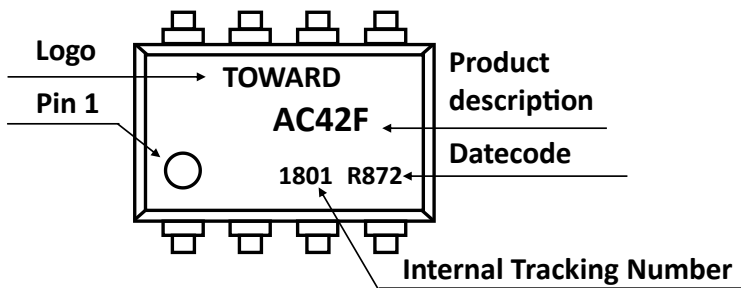

DATE CODE

Example: R872

R		8		7		2	
Material Characteristics		Year		Month		Week of the Month	
R	RoHS compliant	8	2018	1	Jan	1	1 st
		9	2019	2	Feb		
		A	2020	3	Mar		
		B	2021	4	Apr		
H	Halogen free	C	2022	5	May	2	2 nd
		3	3 rd
		G	2026	12	Dec	4	4 th

RELIABILITY TESTS ▲ STANDARD

Standard: JESD22-A

No.	Test	Test Specification	Test Standard	Test Limits
1	Moisture Sensitivity Level Test	Bake condition: Temperature: 125°C; Duration 24 hours Soak condition: Temperature: 30°C; Humidity: 60% RH Duration 192 hours Reflow condition: Peak temperature: 260°C Duration: 3 cycles	JESD22-A113H	No abnormal phenomenon was found. Functional test passed.
2	High Temperature Storage Test	Temperature: 150°C Duration: 500 hours	JESD22-A103E	No abnormal phenomenon was found. Functional test passed.
3	Temperature Cycling Test	Temperature range: -55°C to +125°C -55°C for 30 minutes +125°C for 30 minutes Duration: 100 cycles with 1 cycle = 70 minutes	JESD22-A104E	No abnormal phenomenon was found. Functional test passed.
4	Low Temperature Storage Test	Temperature: -40°C Duration: 500 hours	JESD22-A119E	No abnormal phenomenon was found. Functional test passed.
5	Temperature & Humidity Storage Test	Temperature: 85°C Humidity: 85% RH Duration: 500 hours	JESD22-A101D	No abnormal phenomenon was found. Functional test passed.
6	Highly Accelerated Temperature and Humidity Stress Test	Temperature: 130°C Humidity: 85% RH Duration: 96 hours	JESD22-A-118B	No abnormal phenomenon was found. Functional test passed.

REVISION TABLE

Revision	Date	Status	Notes
001	01/04/2022	Initial release	Initial publication

DISCLAIMER

Except for the written expressed warranties, MGT does not implicitly, by assumption or whatever else, warrant, undertake, promise any other warranty or guaranty for any MGT product.

All information and technical specifications made available by MGT are for guidance only and we reserve the right to change or modify them without prior notice. Unless expressly stated in writing by MGT, we reject any guarantees, obligations, or warranties.

All MGT products with the technical specifications described are suitable for use in certain applications. Operating, production, storage and environmental conditions can have a massive influence on the parameters mentioned in the data sheets, which cause the performance to vary over time.

It is subject to the user's duty of care to design and validate his products in such a way that appropriate measures are taken, such as protective circuits or redundant systems to ensure the safety standards required in the application.

MGT components are not designed or rated for use in life support, rescue, safety critical, military, or aerospace applications where failure or malfunction could result in property or environmental damage, serious injury or death. In the aforementioned cases, please contact us before using MGT products.

In principle, we reserve all rights and MGT's general terms and conditions apply. You can find them on our website www.mgt.co.com.