



HITACHI

ABB

IGCT Semiconductors for Reliable, High Power Applications such as Off-Shore Wind, Rail-Intertie or Medium Voltage Drives

Thomas Stiasny - Senior Principal Engineer Bipolar Technology
Christian Winter - Global Product Manager, BiPolar Semiconductor devices

POWERING GOOD FOR SUSTAINABLE ENERGY

2020-07-06

HITACHI ABB POWER GRIDS

© Hitachi ABB Power Grids 2020. All rights reserved

- How does an IGCT work
- Different types of IGCTs
- IGCT design – reliability / power handling capability

IGCT phase: Thyristor

Conduction

Conducting state of IGCT

Thyristor mode active

Electron emission from cathode

Hole emission from anode

Very low on-state voltage drop

Structure

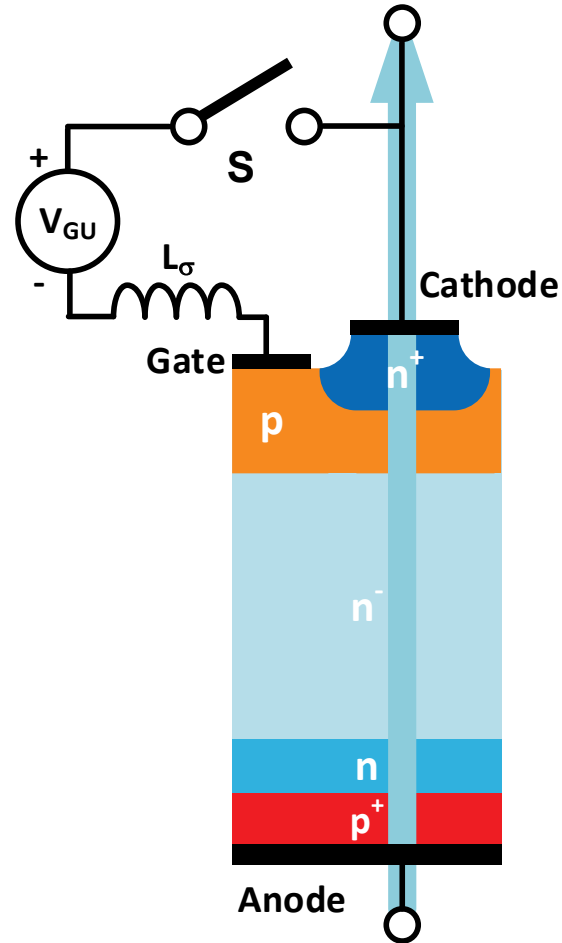

Current / voltage wave form

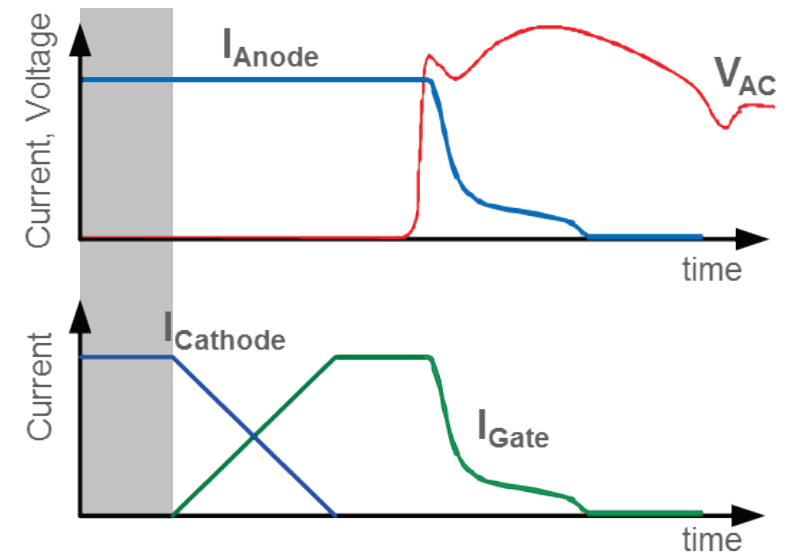

IGCT phase: Thyristor

Current commutation

Anode current commutates from Cathode to Gate

$$\text{Commutation } dI_{\text{Gate}}/dt = V_{\text{GU}}/L_{\sigma}$$

Low inductive Gate circuit necessary

Structure

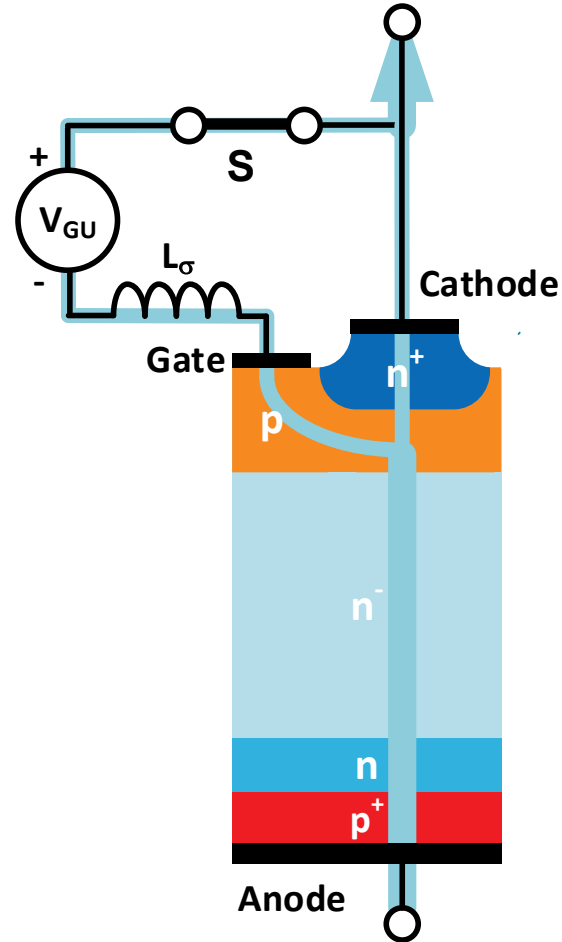

Current / voltage wave form

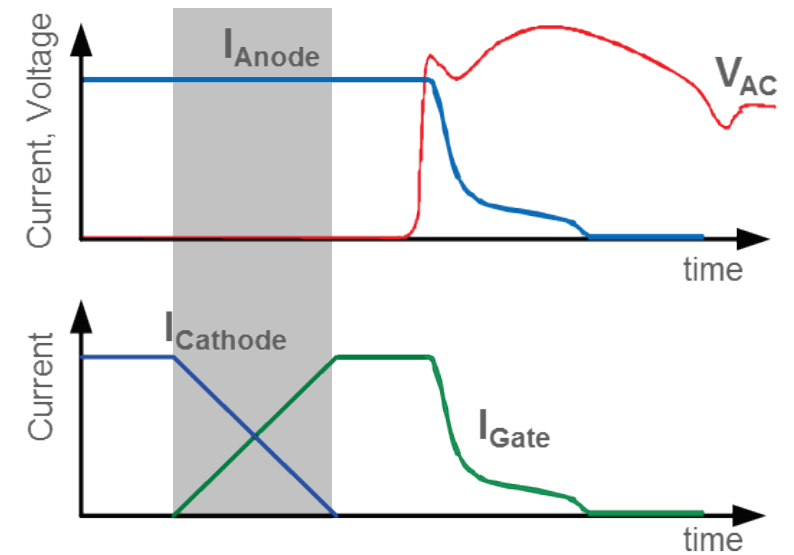

IGCT phase: Transistor

Anode current commutated to Gate

Transistor mode activated

Cathode fully bypassed though Gate Unit

Thyristor converted to open base pnp Transistor

Hard drive condition: commutation before V_{AK} rises

Commutation time $\sim I_T \cdot L_\sigma / V_{GU}$

Structure

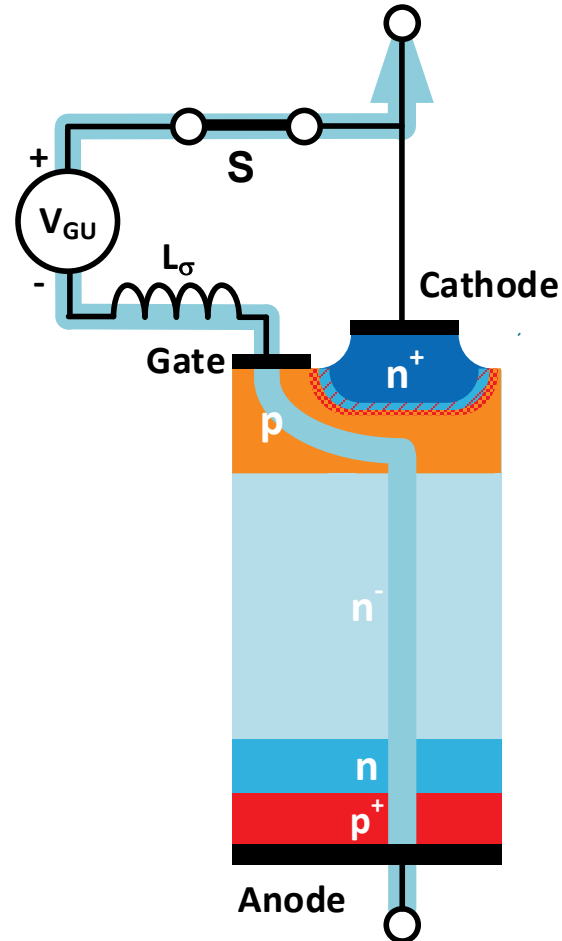

Current / voltage wave form

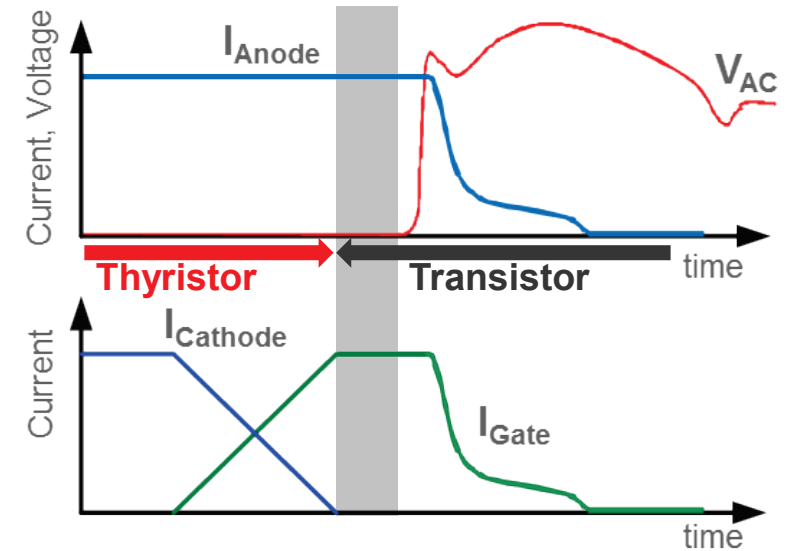

IGCT phase: Transistor

Turn-off as Transistor

Extraction of Charge carriers through Anode and Gate

Turn-off di/dt defined by device

Tail current participates to dynamic losses

Structure

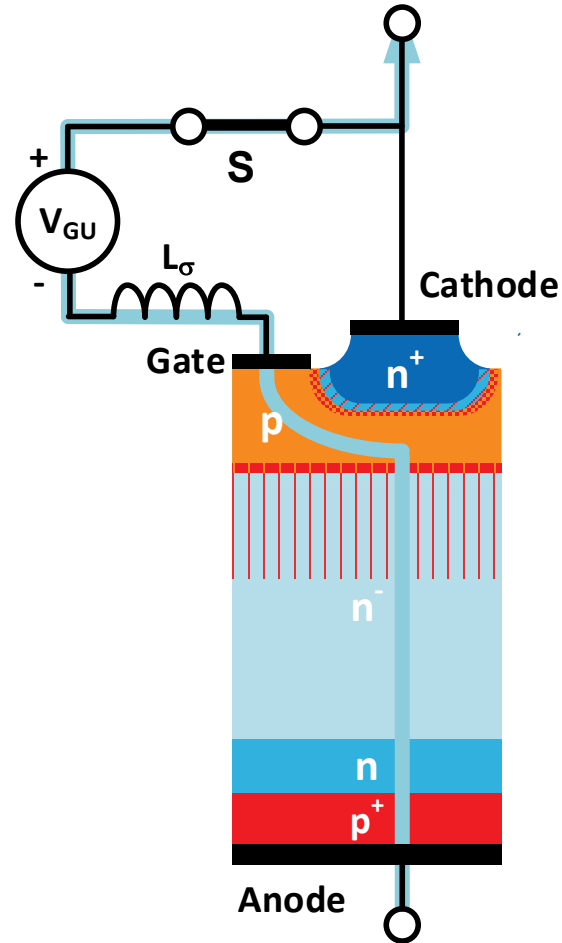

Current / voltage wave form

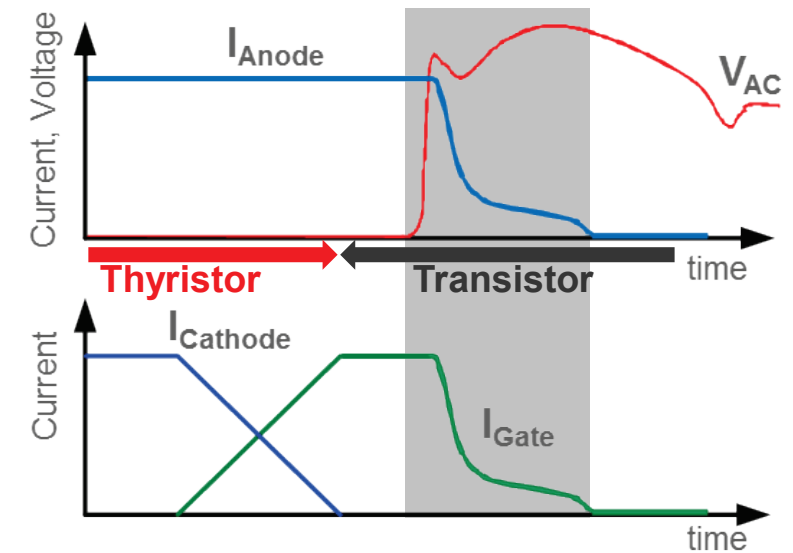

IGCT phase: Transistor

Blocking device

Transistor mode active

High dV/dt immunity through low inductive Gate – Cathode coupling (for powered Gate unit)

Structure

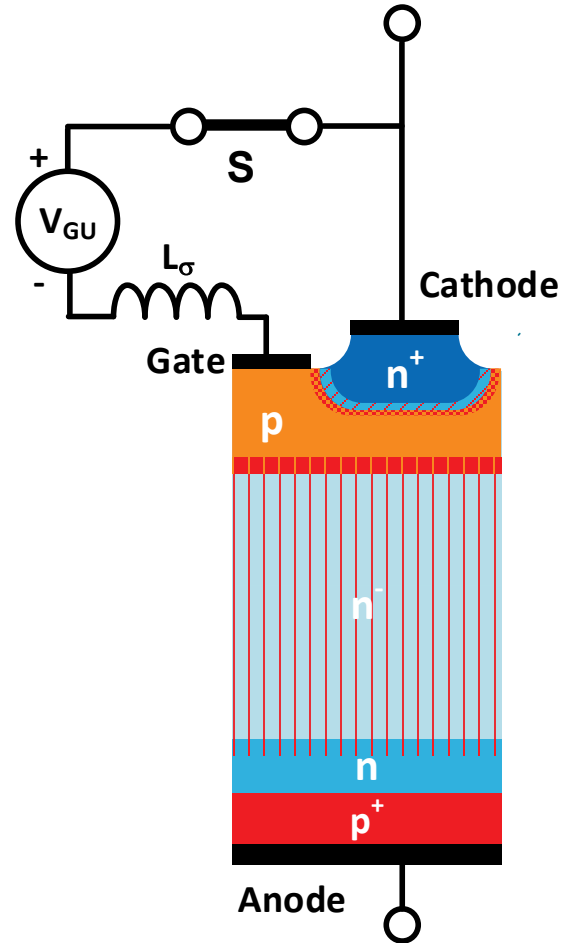

Current / voltage wave form

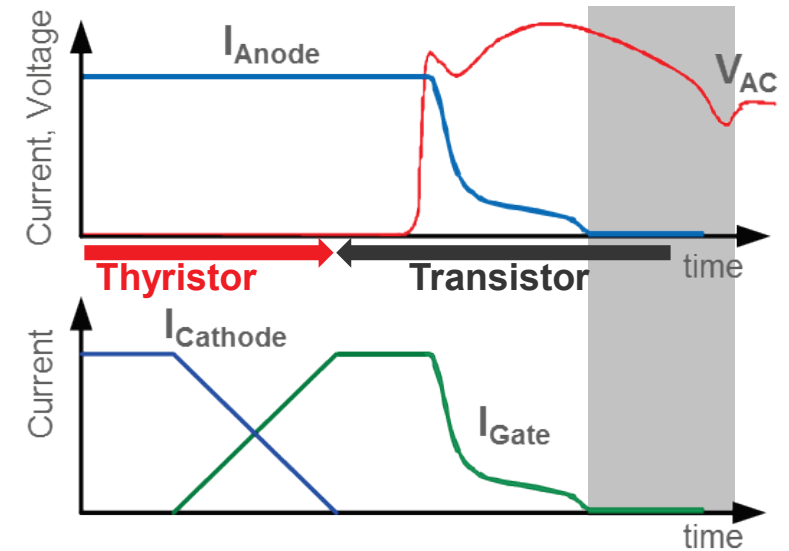

IGCT Gate circuit requirements

The Thyristor is a current driven device

IGCT operation requires low inductive coupling of gate unit and power semiconductor

- Distributed gate on silicon wafer
- Low inductive package for power semiconductor
- Integration of power semiconductor and gate unit
- Low inductive gate unit

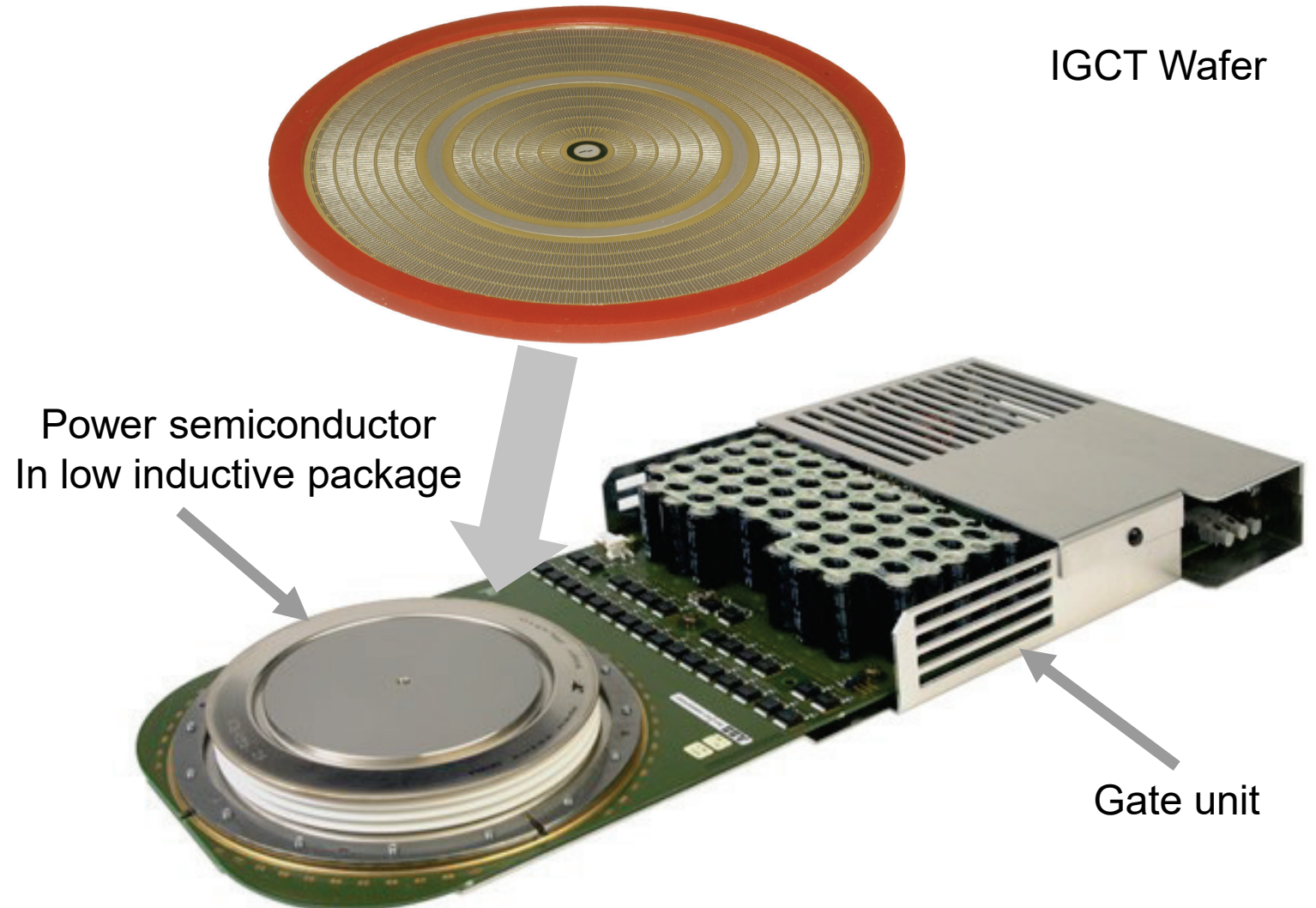

Asymmetric IGCT

- Full forward blocking capability
- Reverse blocking capability ~ 20V
- Typically used with antiparallel diode
- Used in voltage source inverters

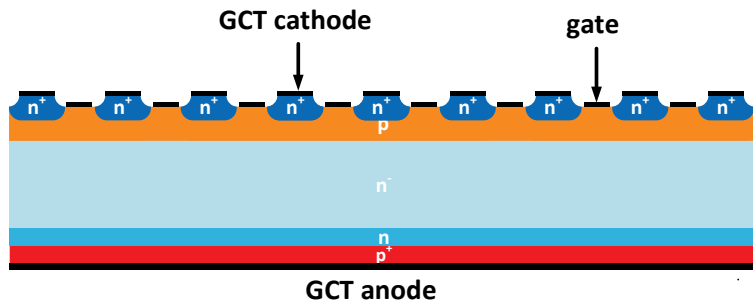

Reverse conducting IGCT

- Full forward blocking capability
- Integrated antiparallel diode
- Used in voltage source inverters

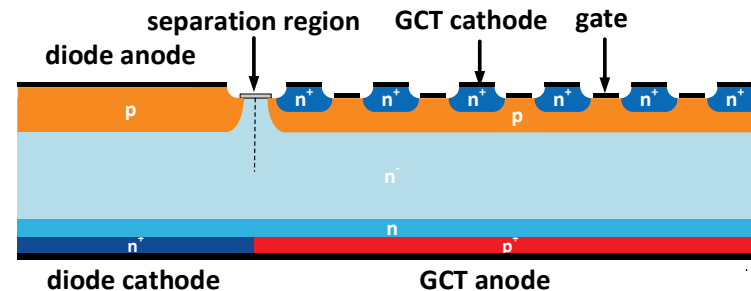
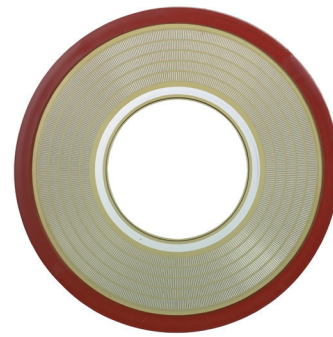

Reverse blocking IGCT

- Full forward blocking capability
- Full reverse blocking capability
- Typically used in current source inverters, breakers

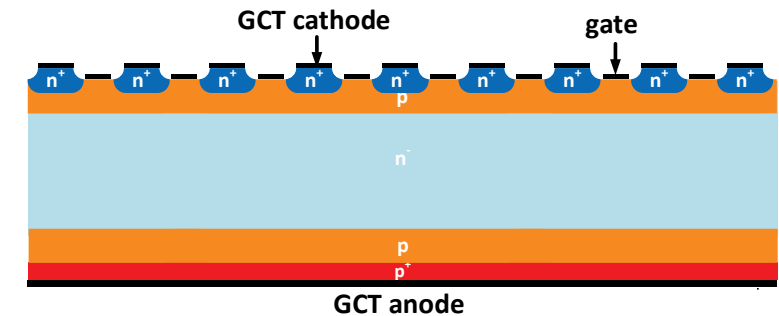

Typical IGCT circuit

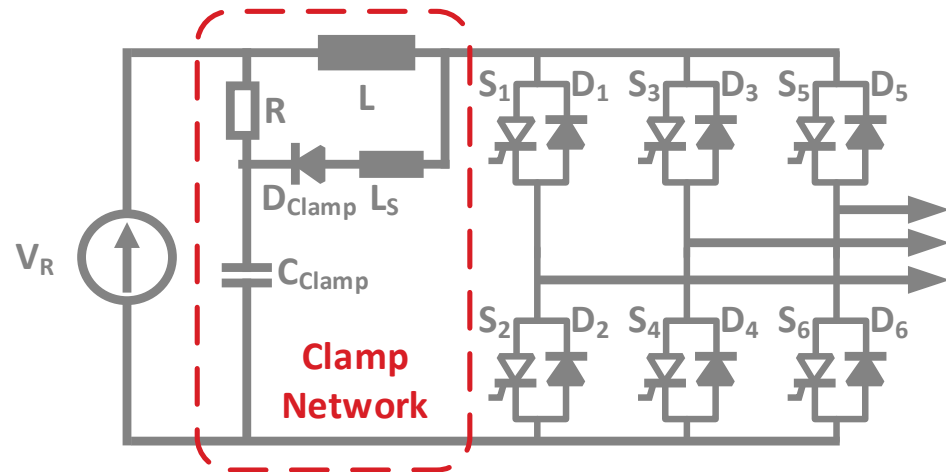

- No di/dt control by switch possible
- extra components (Clamp Network)
- no significant turn-on losses in devices
- imitted fault current
- circuit is **mandatory for IGCTs** (optional for transistors)

Typical IGBT circuit

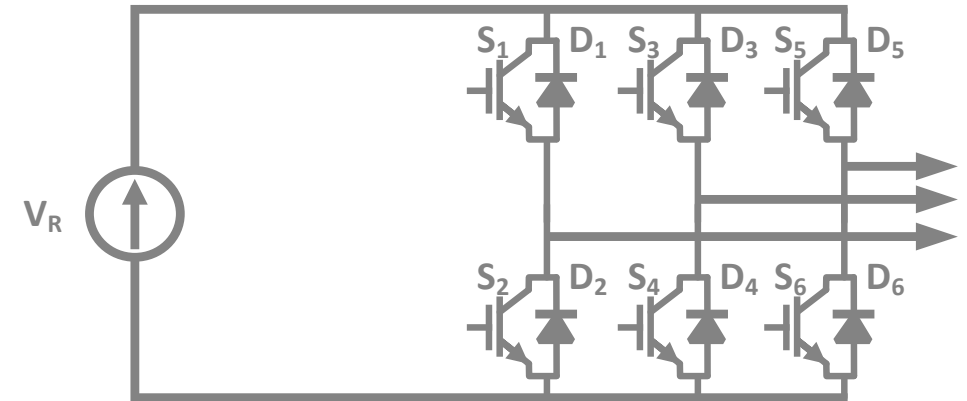

- Turn-on di/dt limited by switch
- no passive components
- turn-on losses in S1-6
- no fault current limitation
- circuit is suitable for **Transistors only**

Design

Thyristor structure

Monolithic silicon design

Pressure contact design (no bond wire or solder layer)

Hermetic ceramic housing

Gate unit with redundancy in turn-off circuit

Reliability – Power handling

Lowest On-state losses possible

Optimal ratio active area to edge termination

Low part count of power semiconductor

High ruggedness against load cycling aging

Double side cooling for superior thermal management

Failure mode: Short circuit, optimal for applications with redundancy

Power semiconductor well protected against environmental influences (e.g. humidity)

High field reliability of gate unit

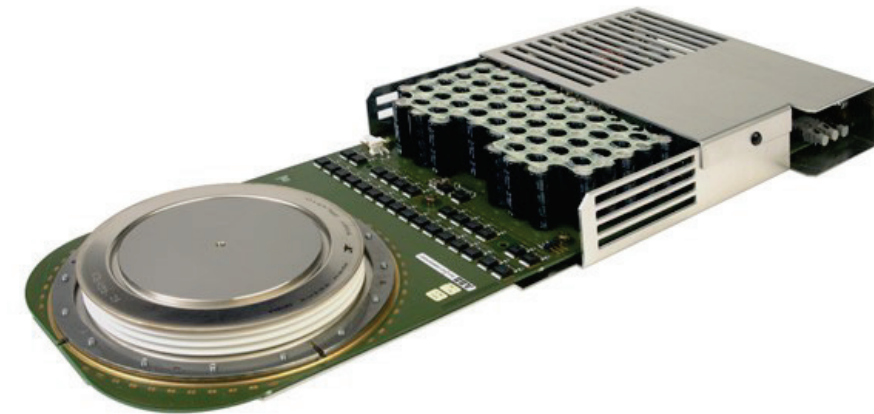

- New 4.5 kV Reverse Conducting (RC) IGCT
- IGCT reliability
- New 4.5 kV Asymmetric IGCT
- 10 kV IGCT
- 2.5 kV Revers Blocking (RB) IGCT
- Fast recovery diode (FRD) platform



Voltage classes, V		Reverse Conducting (RC)			Asymmetric	Reverse Blocking (RB)	
		F / H	L	Y	L	H	L
Voltage classes, V	10000						
	6500						
	5500						
	4500						
	2500						
		F / H	L	Y	L	H	L
		47/63	85	138	85	63	85
Housing / Pole-piece diameter (mm)							

Product
 Sample

- Introduced >20 years ago by Hitachi ABB PG.
- Various sizes and voltage classes.
- Three device variants.
- Used in wide application range.



New 4.5 kV 3600 A reverse conducting IGCT

- New Gen3 4.5 kV reverse-conducting IGCT platform in L housing (85 mm).
- Device is available in two variants, one optimized for medium switching frequency application, such as MVD and wind power converter, the second optimized for low switching frequency intended for use in multi-Level modular converter (MMC) for e.g. static synchronous compensators (STATCOMs) or pumped hydro plants.
- The turn-off current of 3600 A is a record value in its class. For the converter manufacturer it means a significantly compact design than previously.

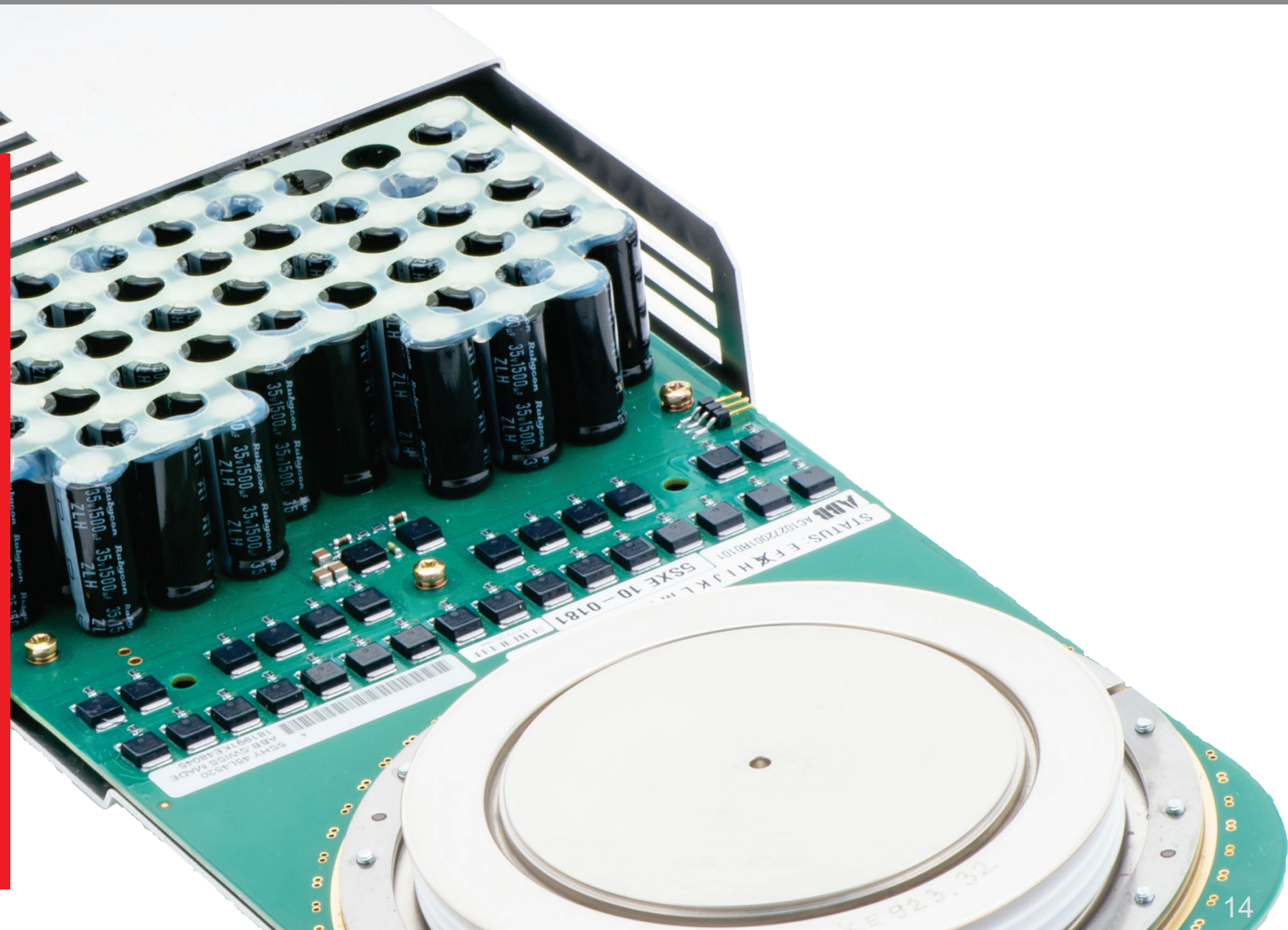

Gen3 design features

- Retain the current outer dimensions for compatibility with the application and integrated gate unit.
- Gen 3 optimization focus: turn-off and thermal performance:
 - Increased device diameter through efficient use of raw silicon wafer.
 - Minimal gate-circuit impedance – achieved by using a gate contact infrastructure at the device's periphery and by optimized routing of the gate contact through the housing.
 - Turn-off current increased by adjusting doping profile.

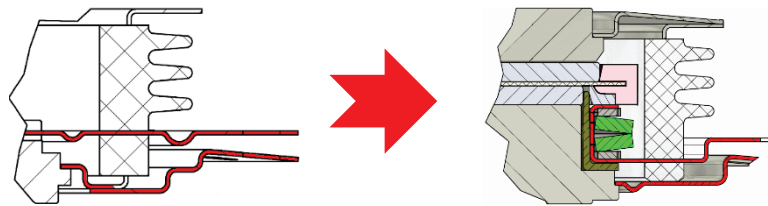

previous

new

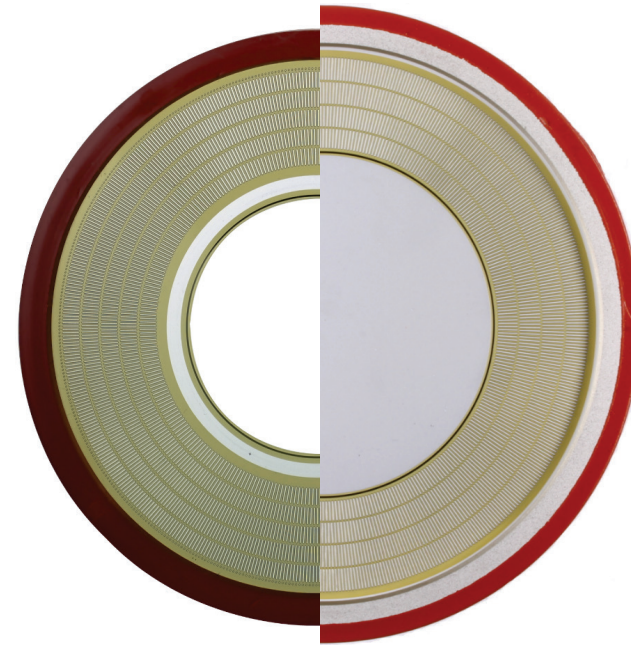

Previous

- Ring gate
- Two part cathode side Molybdenum disk
- Symmetric anode and cathode side pole- piece thickness

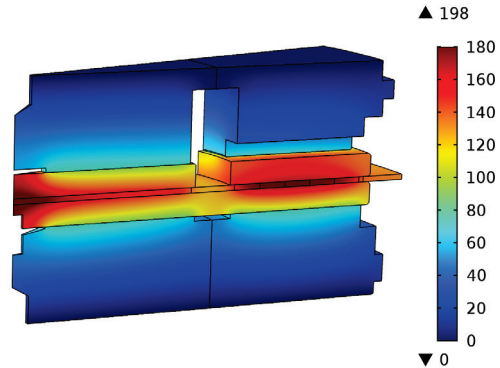

New

- Outer ring gate
- Monolithic Molybdenum disk
- Asymmetric anode and cathode side pole- piece thickness

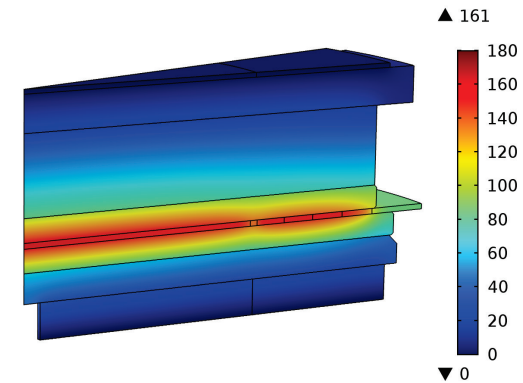

Improved thermal design for more performance and improved reliability

Field reliability “Gotthard lift”

- Devices removed from Sedrun, Gotthard lift application.
- 15 years heavy duty operation in lift drive. Known load profile and number of cycles.
- 28,200,000 tons excavated gravel with lift.
- Traces of wear-out were found but degradation was low. Example shows the minimal degradation of the cathode metallization.

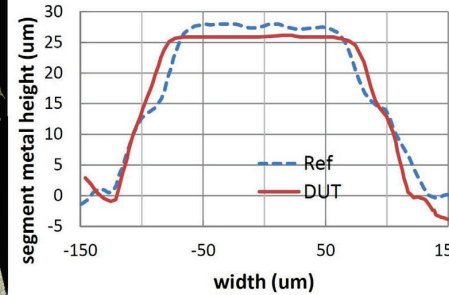
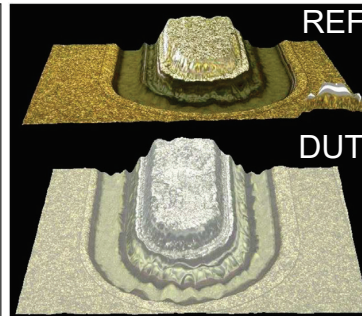
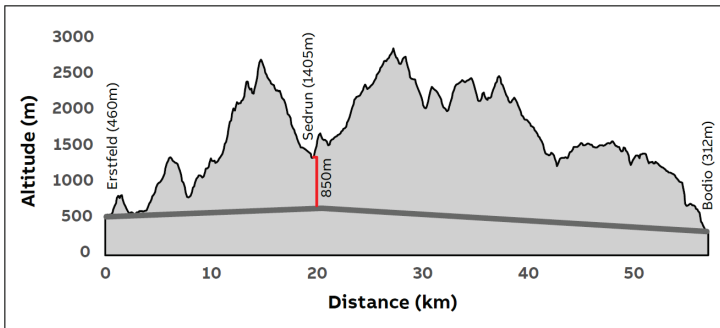

Field Failure Rate (FIT) of GCT and gate unit [1]

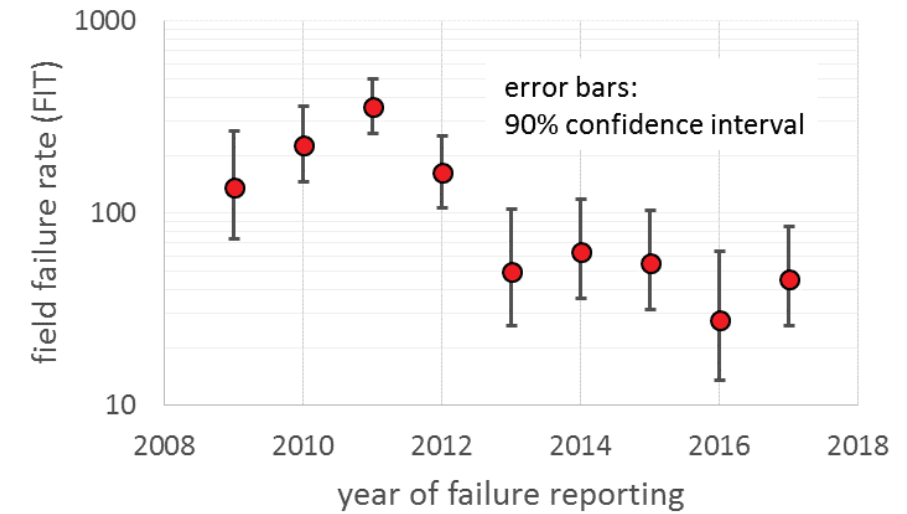

Field reliability of IGCTs is state-of-the art and constantly improving over time.

[1] Th. Stiasny, O. Quittard, Ch. Waltisberg, U. Meier. Reliability evaluation of IGCT from accelerated testing, quality monitoring and field return analysis. Proc. ESREF, Denmark, 2018.

Field failure rate FIT: Device field failure of specific customers are monitored. r: reported field failures per reporting year. Device failures are analyzed: Number N of devices in this application known. Uptime per year estimated to T = 6000h/year. Field failure rate is calculated in FIT (device failure in 10⁹ device hours). Field failure rate = (r · 10⁹)/(N · T)

Gate unit reliability

- The turn-off circuit of the IGCT gate unit consist of parallel connected electrolytic capacitors (voltage source) and parallel operated MOSFETs to connect gate – cathode to the capacitor.
- The well-known aging of electrolytic capacitors (increased impedance due to dry-out of electrolytes) is considered in the design by redundancy.
- Analyzed IGCTs after 15years of field operation did no show any degradation of the gate circuit impedance.
- Field returns never showed a device failure due to break-down of a electrolytic capacitor of a MOSFET in the turn-off circuit.

Gate circuit aging [1]

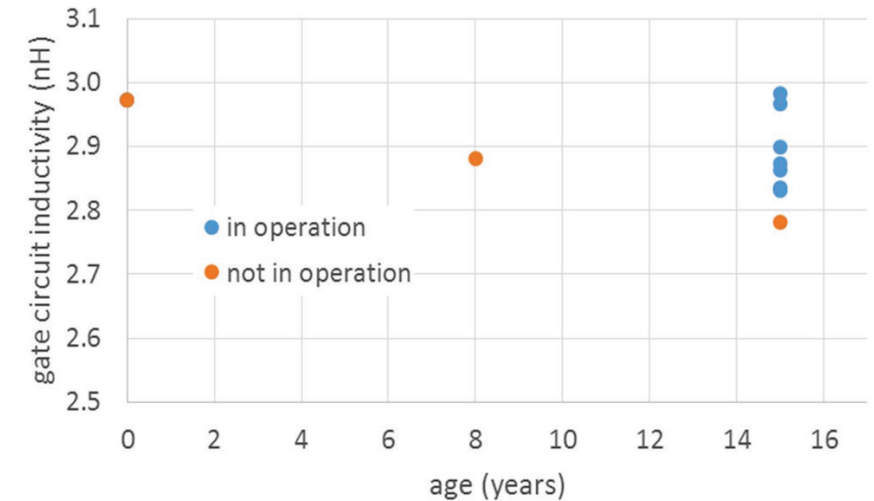

Field experience proves good gate unit reliability (23 years of field experience)

[1] Th. Stiasny, O. Quittard, Ch. Waltisberg, U. Meier. Reliability evaluation of IGCT from accelerated testing, quality monitoring and field return analysis. Proc. ESREF, Denmark, 2018.

- New Gen 3 4.5 kV asymmetric IGCT platform in L housing (85 mm) is in final product development stage. Samples available now. Volume production Q1 2021.
- Based on gen3 technology platform for 4.5 kV, RC-IGCT allows for cost optimization due to streamlining process and supply chain.
- Device will be available in two variants, one optimized for medium switching frequency a second for low switching application.
- The outstanding performance makes the device ideal for off-shore wind application in the range of 10-15 MW+.
- Additional applications are STATCOMs, rail-intertie, pumped hydro or medium voltage drives to mention a few.
- The turn-off current target is 6500 A, a significant step ahead compared to previous generation devices.

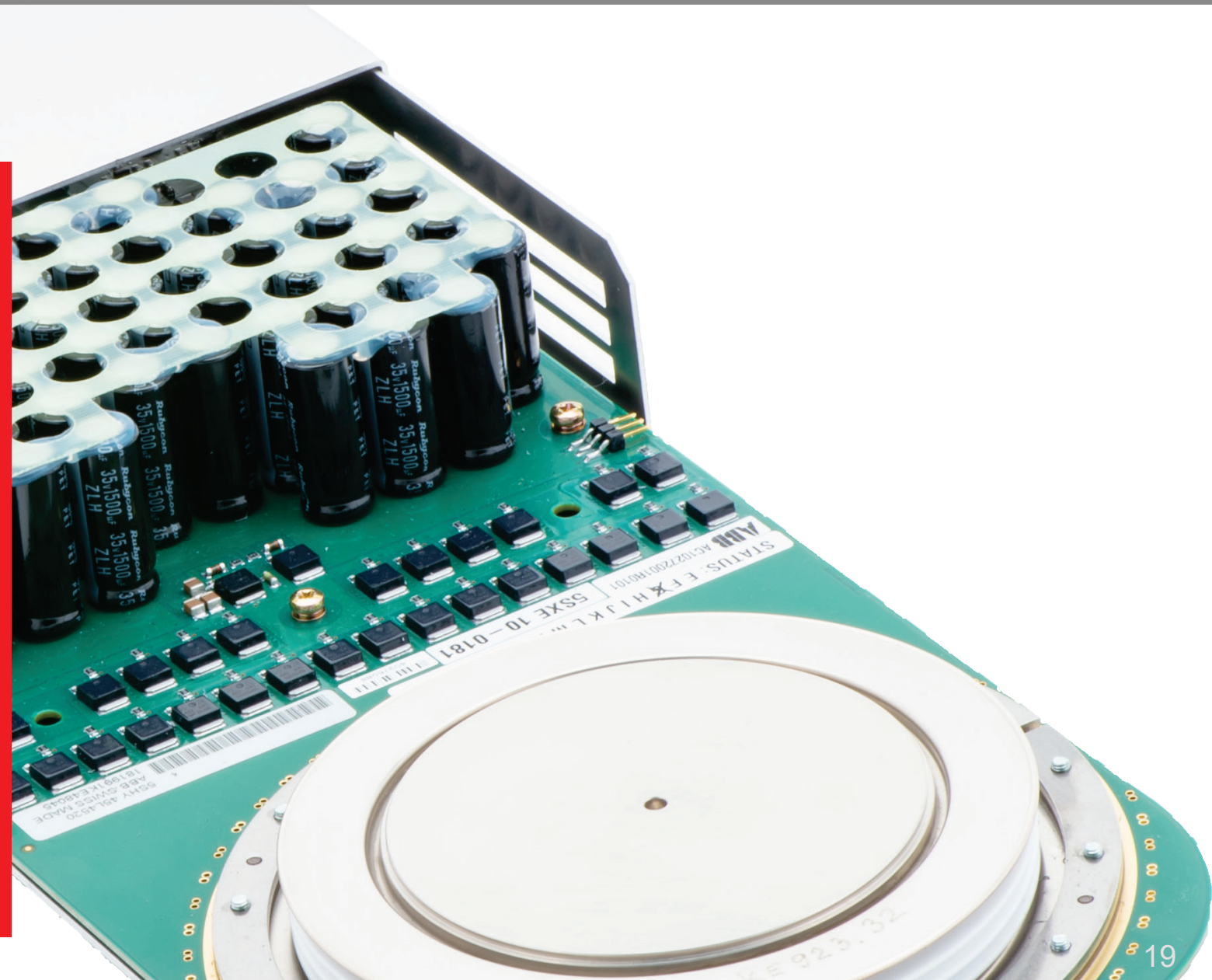

Key device parameters

	Generation 1	Generation 2	Generation 3
Parameter	5SHY 35L4520	5SHY 55L4520	5SHY 65L4521
Status	Product	Product	Under development Samples Q4/2020
Tjmax (°C)	125	125	140
ITGQM (kA)	4 kA (@2.8kV)	5 kA (@2.8kV)	6.5 kA (@2.8kV)
Rthjc (K/kW)	8.5	8.5	6.8

SOA - Example for turn-off capability

- VDC = 2.8 kV
- Tj = 140 °C
- IT = 8 kA

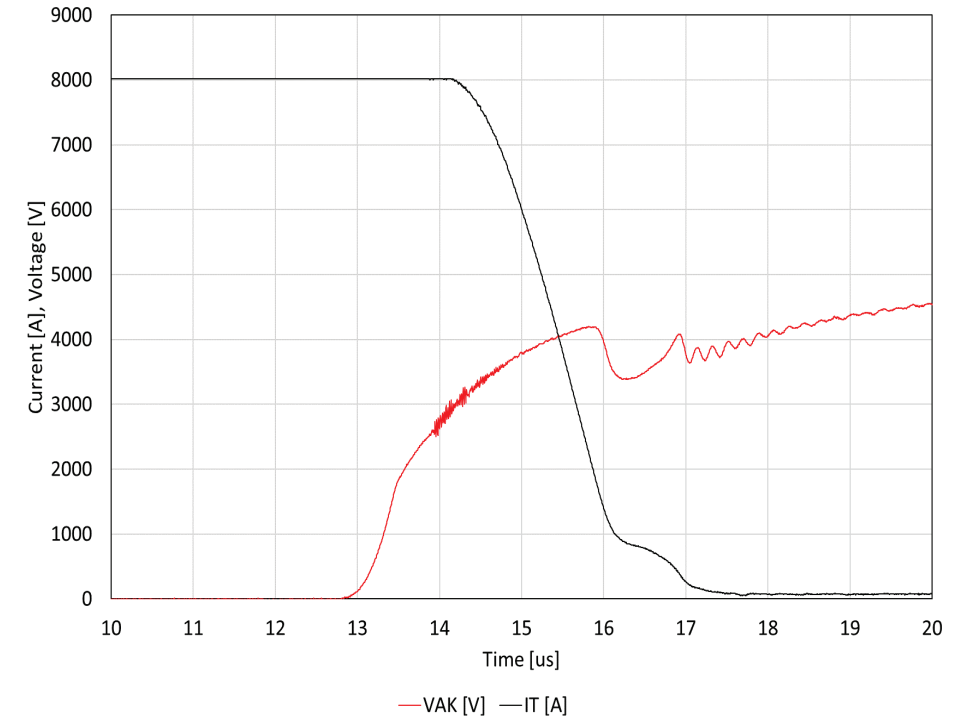

Gen3 device offers significant thermal and turn-off current increase. Device footprint identical to previous generations.

Frequency test

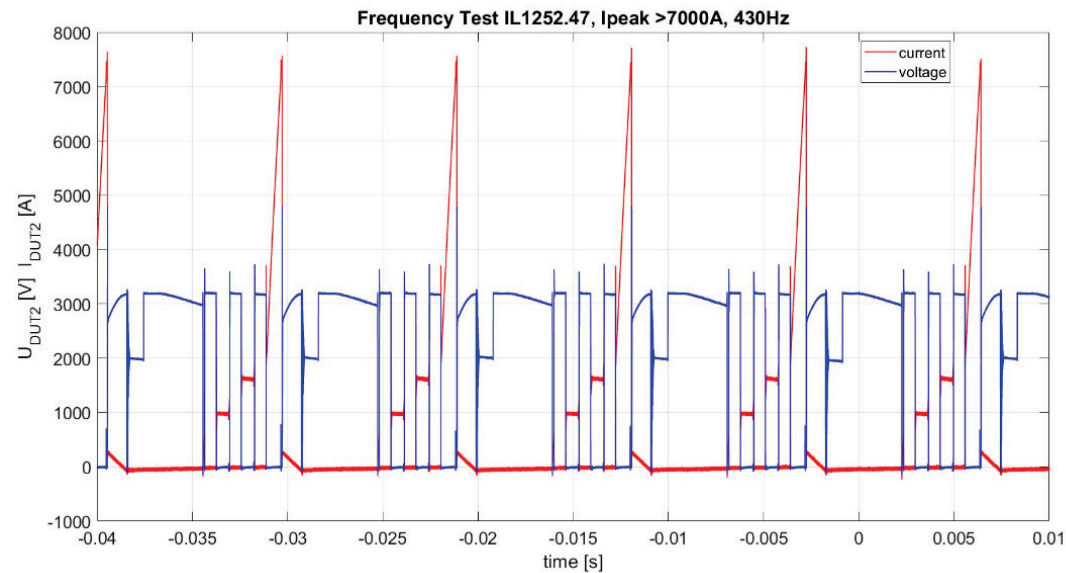

Turn off capability in frequency

VDC = 2.8 kV IT=7.3kA F=430Hz

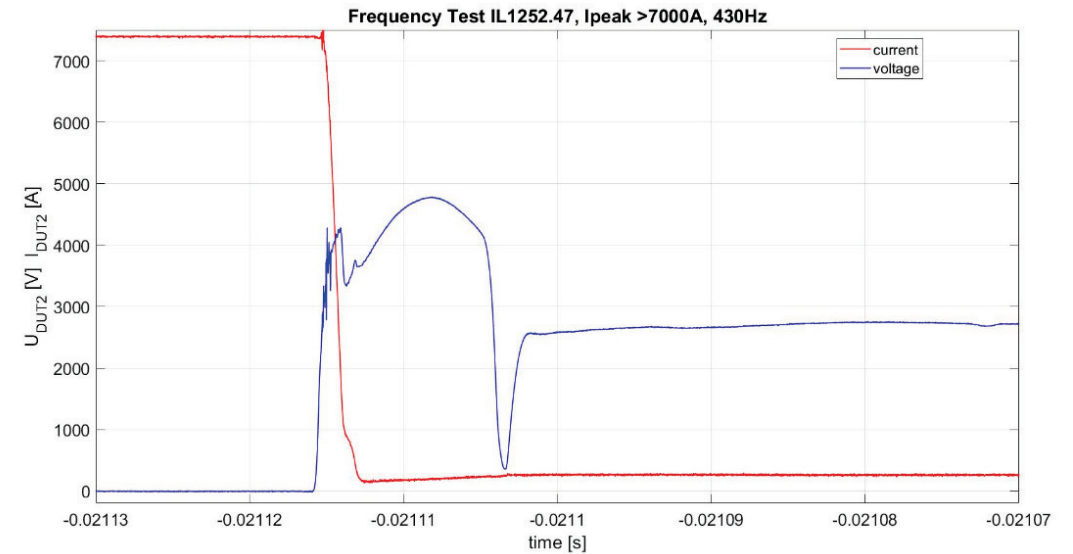

Benchmark in turn-off capability in frequency

Goal

Develop high voltage IGCTs & companion Fast Recovery Diode (FRD) for high power applications (10-15 MW+)

Targeted applications: Offshore-wind, pulse power

10kV devices

RC-IGCT (L-housing)



RC-IGCT (for >10MW)

SOA : 5.3kV, 2kA, 125°C

Soft reverse recovery

Eng. samples available

FRD (L-housing)

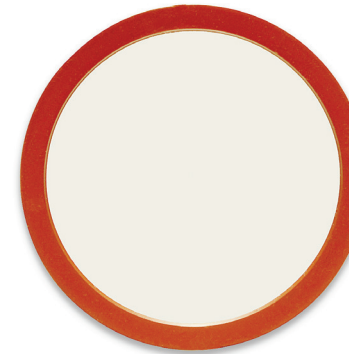

FRD (as NPC, clamp, FWD)

SOA : 6.0kV, 4.1kA, 600-800A/us

Soft reverse recovery

Eng. samples available

A-IGCT (L-housing)

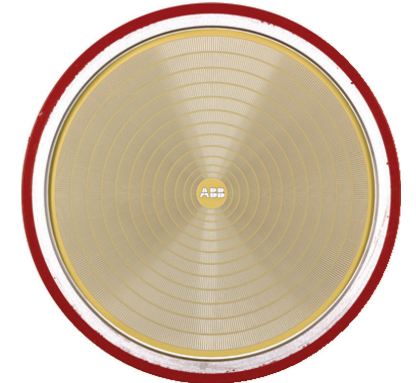

A-IGCT (for >15MW)

GCT mode: TC at 4.7kV, 1.7kA, 125°C

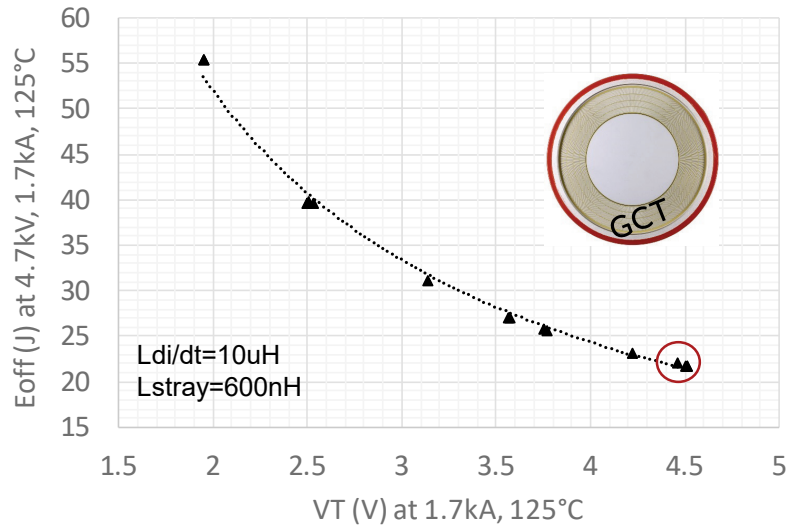

Targeted: $V_T = 4.5V$ & $E_{off} = 22 J$

Diode-mode: TC at 4.7kV, 1.7kA, 125°C

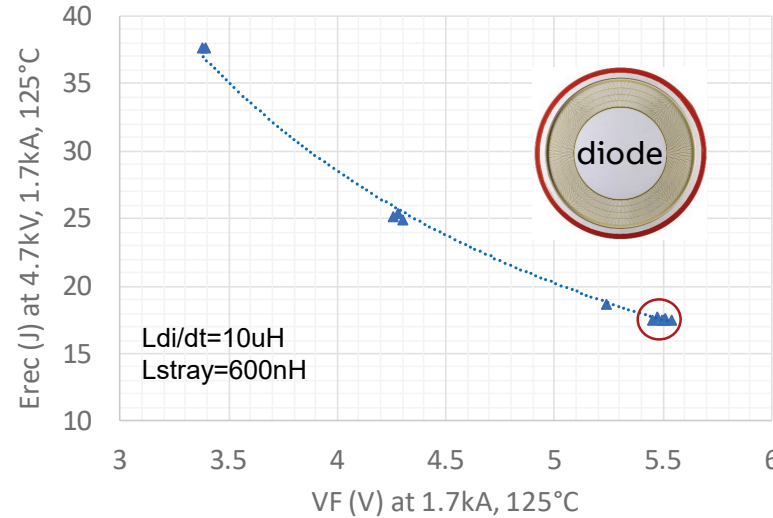

Targeted: $V_F = 5.5V$ & $E_{rec} = 18 J$

discrete FRD: TC at 4.7kV, 1.7kA, 125°C

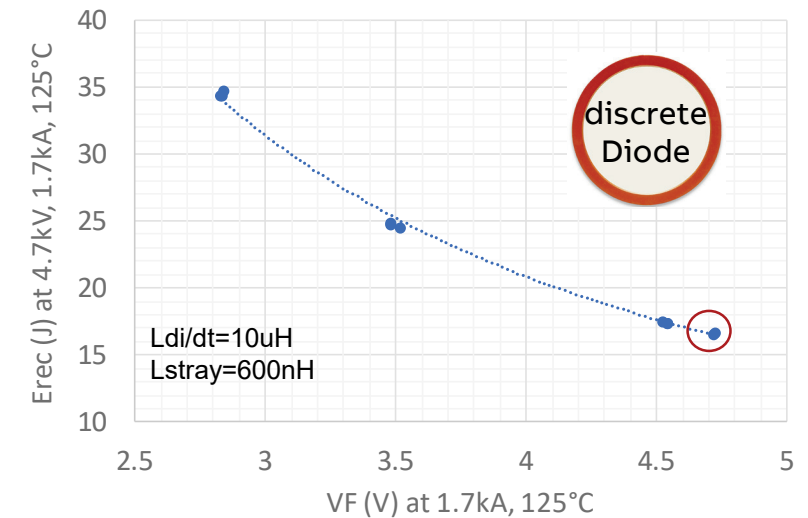

Targeted: $V_F = 4.7V$ & $E_{rec} = 17 J$

2.5 kV Reverse blocking IGCT

- Designed and optimized for extreme low conduction losses and highest turn-off current capability (up to 6kA).
- Record low on-state losses of below 1 kW at 1 kA, enables customer to design applications with highest efficiency ratings.
- Optimized for DC Solid State Circuit Breaker (SSCB) application. SSCB allows to interrupt fault currents faster than ever before, 100 times compared to traditional electro-mechanical breakers.
- Samples available now

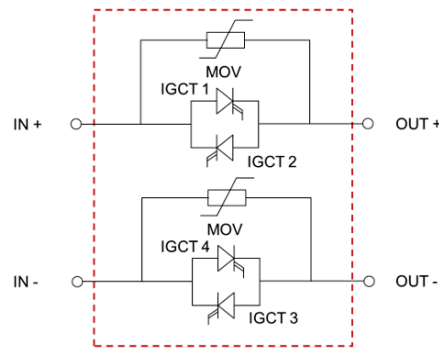

Fast recovery diode (FRD) platform

- Improvement program for our existing and leading FRD platform. Adding large size product.
- New generation of companion L size (85 mm pole-piece) diode for next gen3 asymmetric IGCT allows fully utilization of IGCT.
- New large size FRD used in HVDC / DC breaker as free-wheeling diode.
- Samples available Q2/2021

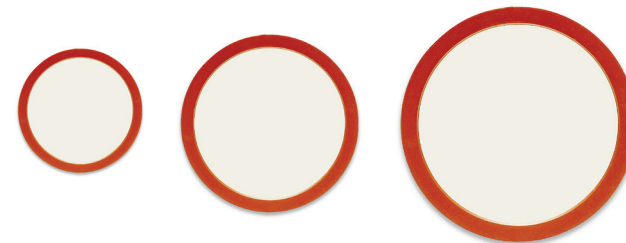

HITACHI

