



5SDD 48H3200

Old part no. DV 889-4650-32

Rectifier Diode

Properties

- Industry standard housing
- Suitable for parallel operation
- High operating temperature
- Low forward voltage drop

Key Parameters

V_{RRM}	=	3 200	V
I_{FAVm}	=	4 708	A
I_{FSM}	=	61 000	A
V_{TO}	=	0.992	V
r_T	=	0.067	mΩ

Types

	V_{RRM}
5SDD 48H3200	3 200 V
Conditions:	$T_j = -40 \div 160 \text{ }^\circ\text{C}$, half sine waveform, $f = 50 \text{ Hz}$

Mechanical Data

F_m	Mounting force	$50 \pm 5 \text{ kN}$
m	Weight	0.9 kg
D_s	Surface creepage distance	40 mm
D_a	Air str ke distance	20 mm

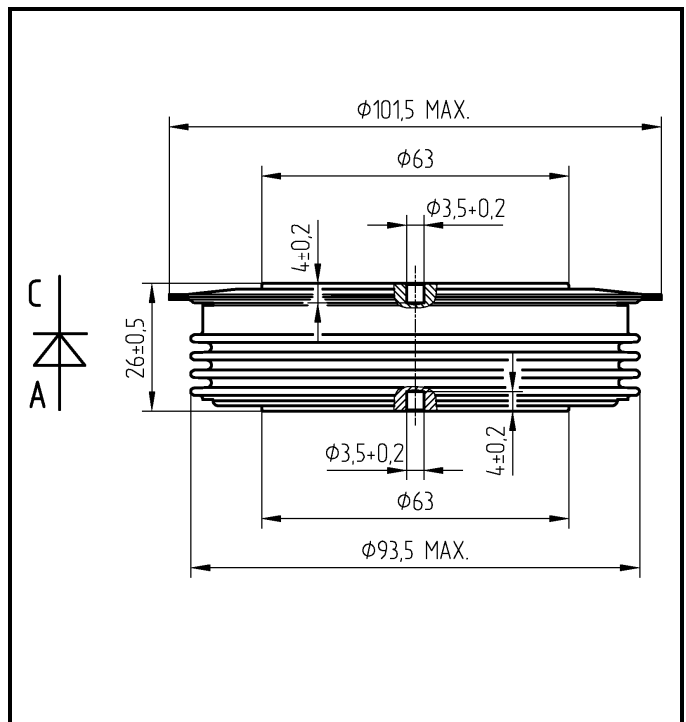

Fig. 1 Case



ABB s.r.o.

Novodvorska 1768/138a, 142 21 Praha 4, Czech Republic

tel.: +420 261 306 250, <http://www.abb.com/semiconductors>

Maximum Ratings		Maximum Limits	Unit	
V_{RRM}	Repetitive peak reverse voltage $T_j = -40 \div 160 \text{ }^\circ\text{C}$	3 200	V	
I_{FAVm}	Average forward current $T_c = 85 \text{ }^\circ\text{C}$	4 708	A	
I_{FRMS}	RMS forward current $T_c = 85 \text{ }^\circ\text{C}$	7 395	A	
I_{RRM}	Repetitive reverse current $V_R = V_{RRM}$	100	mA	
I_{FSM}	Non repetitive peak surge current $V_R = 0 \text{ V, half sine pulse}$	$t_p = 8.3 \text{ ms}$	65 160	A
		$t_p = 10 \text{ ms}$	61 000	A
I^2t	Limiting load integral $V_R = 0 \text{ V, half sine pulse}$	$t_p = 8.3 \text{ ms}$	17 622 000	A²s
		$t_p = 10 \text{ ms}$	18 605 000	A²s
$T_{jmin} - T_{jmax}$	Operating temperature range	-40 ÷ 160	°C	
T_{STG}	Storage temperature range	-40 ÷ 160	°C	

Unless otherwise specified $T_j = 160 \text{ }^\circ\text{C}$

Characteristics		Value			Unit
		<i>min</i>	<i>typ</i>	<i>max</i>	
V_{T0}	Threshold voltage			0.992	V
r_T	Forward slope resistance $I_{F1} = 7\,304 \text{ A, } I_{F2} = 21\,913 \text{ A}$			0.067	mΩ
V_{FM}	Maximum forward voltage $I_{FM} = 4\,000 \text{ A}$			1.200	V
Q_{rr}	Recovered charge $V_R = 100 \text{ V, } I_{FM} = 2000 \text{ A, } di_F/dt = -30 \text{ A}/\mu\text{s}$		4 000		μC

Unless otherwise specified $T_j = 160 \text{ }^\circ\text{C}$

ABB s.r.o., Novodvorska 1768/138a, 142 21 Praha 4, Czech Republic

Thermal Parameters			Value	Unit
R_{thjc}	Thermal resistance junction to case	double side cooling	8.0	K/kW
		anode side cooling	14.5	
		cathode side cooling	18.0	
R_{thch}	Thermal resistance case to heatsink	double side cooling	2.5	K/kW
		single side cooling	5.0	

Transient Thermal Impedance

Analytical function for transient thermal impedance

$$Z_{thjc} = \sum_{i=1}^4 R_i (1 - \exp(-t / \tau_i))$$

Conditions:

$F_m = 50 \pm 5$ kN, Double side cooled

Correction for periodic waveforms

180° sine:	1.0 K/kW
120° sine:	1.5 K/kW
60° sine:	2.5 K/kW
180° rectangular:	0.9 K/kW
120° rectangular:	1.5 K/kW
60° rectangular:	2.5 K/kW

i	1	2	3	4
τ_i (s)	0.4406	0.1045	0.0092	0.0022
R_i (K/kW)	4.533	2.255	0.868	0.345

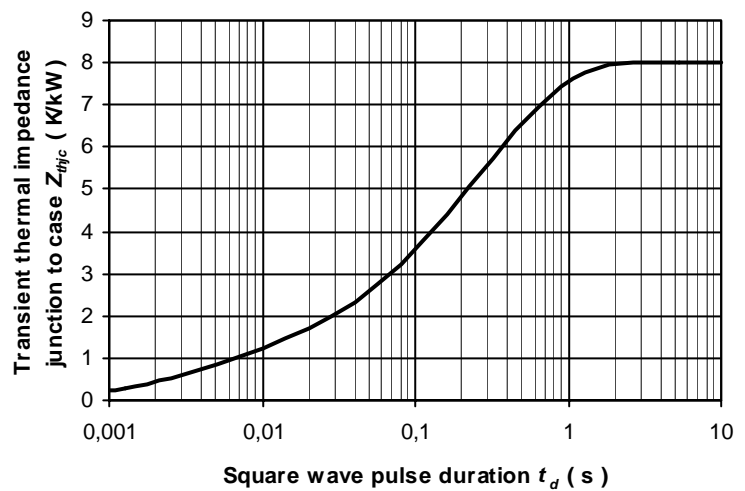

Fig. 2 Dependence transient thermal impedance junction to case on square pulse

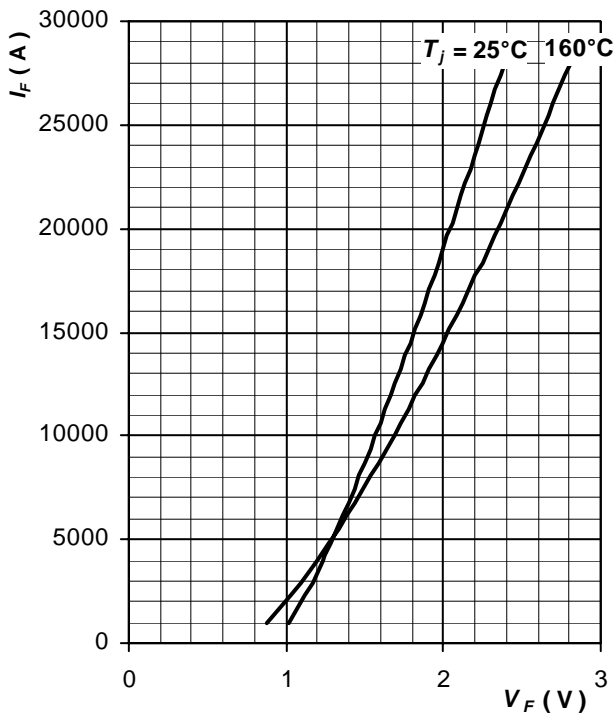

Fig. 3 Maximum forward voltage drop characteristics

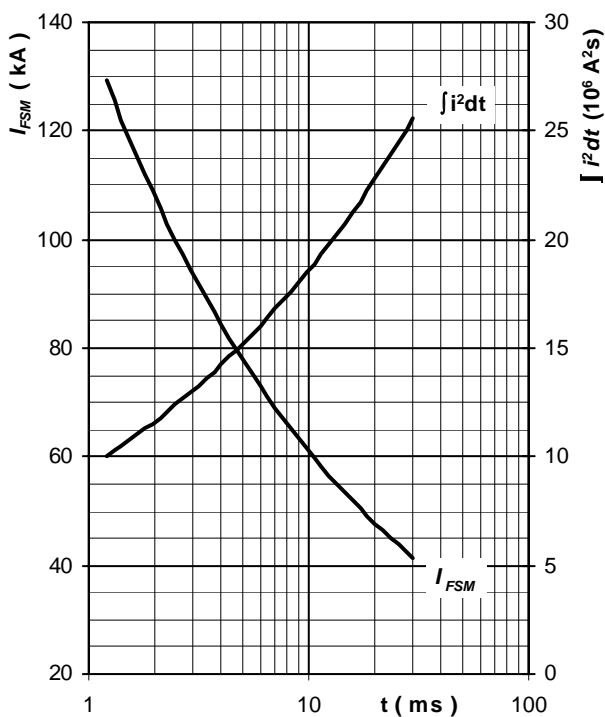

Fig. 4 Surge forward current vs. pulse length, half sine wave, single pulse, $V_R = 0 \text{ V}$, $T_j = T_{jmax}$

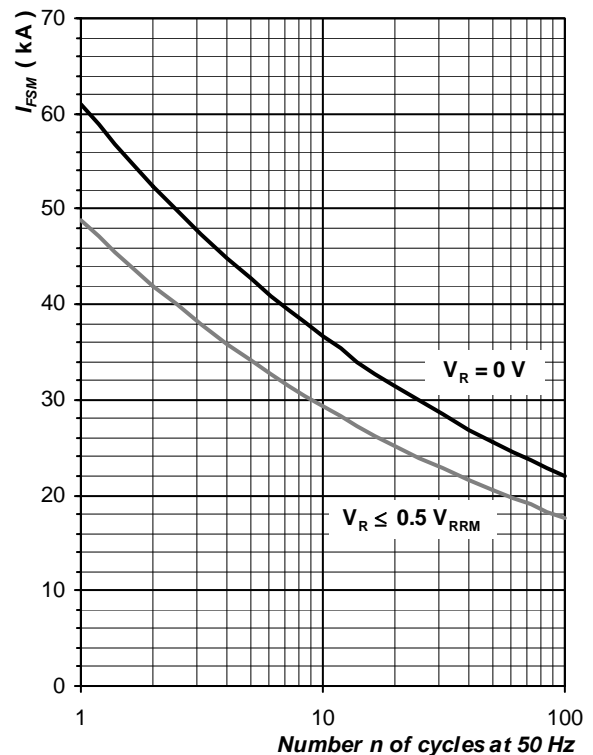

Fig. 5 Surge forward current vs. number of pulses, half sine wave, $T_j = T_{jmax}$

ABB s.r.o., Novodvorska 1768/138a, 142 21 Praha 4, Czech Republic

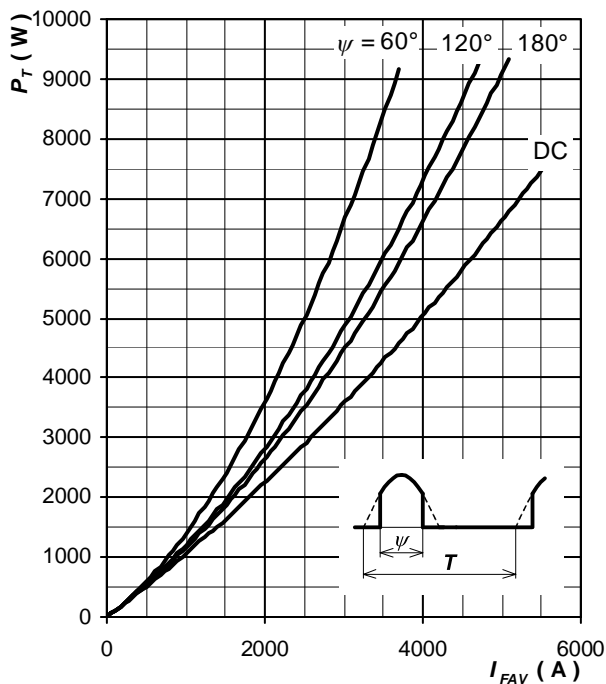

Fig. 6 Forward power loss vs. average forward current, sine waveform, $f = 50 \text{ Hz}$, $T = 1/f$

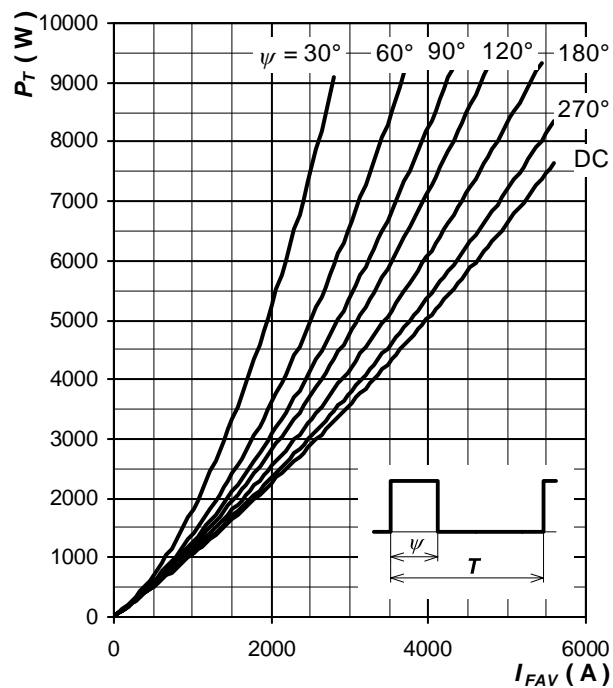

Fig. 7 Forward power loss vs. average forward current, square waveform, $f = 50 \text{ Hz}$, $T = 1/f$

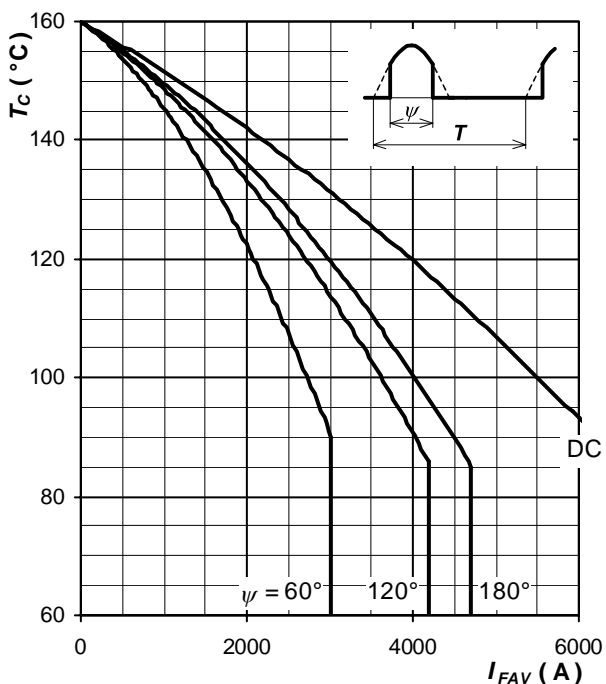

Fig. 8 Max. case temperature vs. aver. forward current, sine waveform, $f = 50 \text{ Hz}$, $T = 1/f$

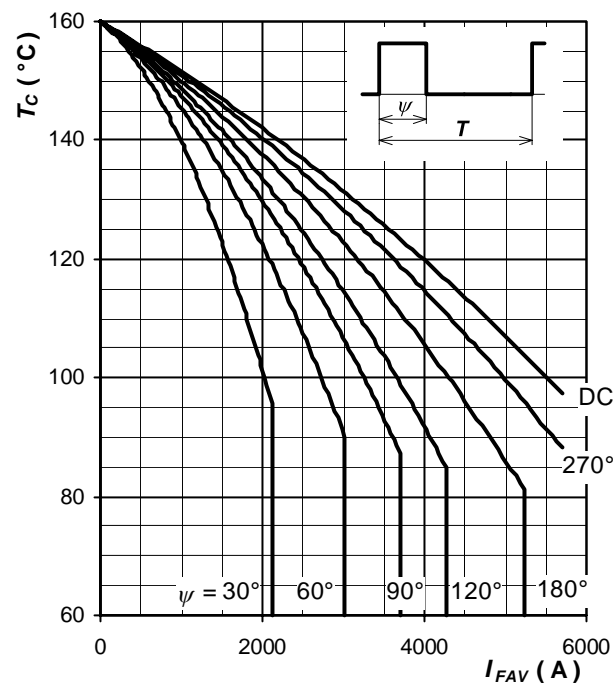

Fig. 9 Max. case temperature vs. aver. forward current, square waveform, $f = 50 \text{ Hz}$, $T = 1/f$

Notes:

ABB s.r.o., Novodvorska 1768/138a, 142 21 Praha 4, Czech Republic