



# 5SDA 21F3204

Old part no. DA 808-2110-32

## Avalanche Diode

### Properties

- low on-state voltage
- avalanche reverse characteristics
- high operational reliability
- suitable for parallel operation

### Key Parameters

$V_{RRM}$	=	3 200	V
$I_{FAVm}$	=	2 110	A
$I_{FSM}$	=	26 000	A
$V_{TO}$	=	0.890	V
$r_T$	=	0.170	mΩ

### Types

	$V_{RRM}$
<b>5SDA 21F3204</b>	<b>3 200 V</b>
Conditions:	$T_j = -40 \div 160 \text{ }^\circ\text{C}$ , half sine waveform, $f = 50 \text{ Hz}$

### Mechanical Data

$F_m$	Mounting force	$22 \pm 2 \text{ kN}$
$m$	Weight	0.46 kg
$D_s$	Surface creepage distance	30 mm
$D_a$	Arrival strike distance	20.5 mm

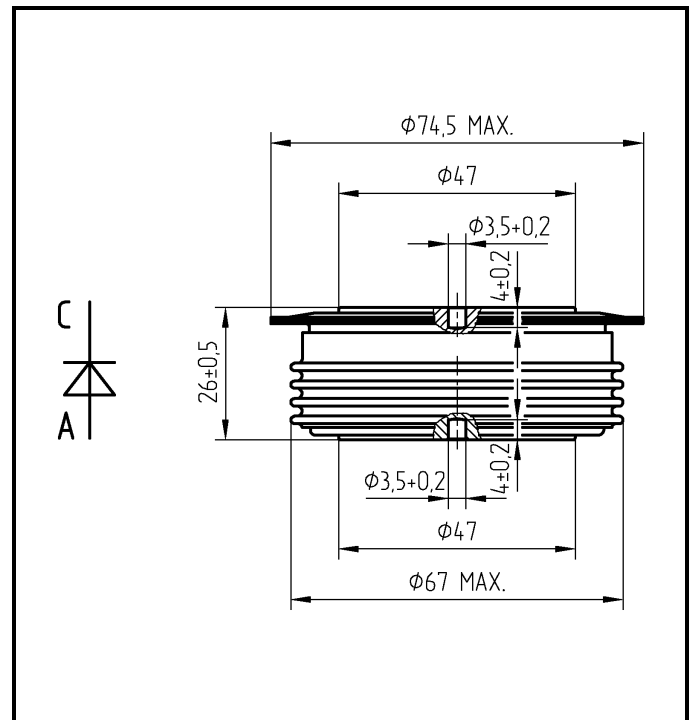

Fig. 1 Case



ABB s.r.o.

Novodvorska 1768/138a, 142 21 Praha 4, Czech Republic

tel.: +420 261 306 250, <http://www.abb.com/semiconductors>

<b>Maximum Ratings</b>		<b>Maximum Limits</b>	<b>Unit</b>	
$V_{RRM}$	<b>Repetitive peak reverse voltage</b> $T_j = -40 \div 160 \text{ }^\circ\text{C}$	<b>3 200</b>	<b>V</b>	
$I_{FAVm}$	<b>Average forward current</b> $T_c = 85 \text{ }^\circ\text{C}$	<b>2 110</b>	<b>A</b>	
$I_{FRMS}$	<b>RMS forward current</b> $T_c = 85 \text{ }^\circ\text{C}$	<b>3 310</b>	<b>A</b>	
$I_{RRM}$	<b>Repetitive reverse current,</b> $V_R = V_{RRM}$	<b>50</b>	<b>mA</b>	
$I_{FSM}$	<b>Non repetitive peak surge current</b> $V_R = 0 \text{ V, half sine pulse}$	$t_p = 8.3 \text{ ms}$	<b>27 800</b>	<b>A</b>
		$t_p = 10 \text{ ms}$	<b>26 000</b>	<b>A</b>
$I^2t$	<b>Limiting load integral</b> $V_R = 0 \text{ V, half sine pulse}$	$t_p = 8.3 \text{ ms}$	<b>3 210 000</b>	<b>A<sup>2</sup>s</b>
		$t_p = 10 \text{ ms}$	<b>3 380 000</b>	<b>A<sup>2</sup>s</b>
$P_{RSM}$	<b>Maximum avalanche power dissipation</b> <i>rectangular pulse 20 <math>\mu</math>s</i>	<b>75</b>	<b>kW</b>	
$T_{jmin} - T_{jmax}$	<b>Operating temperature range</b>	<b>-40 <math>\div</math> 160</b>	<b><math>^\circ\text{C}</math></b>	
$T_{STG}$	<b>Storage temperature range</b>	<b>-40 <math>\div</math> 160</b>	<b><math>^\circ\text{C}</math></b>	

Unless otherwise specified  $T_j = 160 \text{ }^\circ\text{C}$

<b>Characteristics</b>		<b>Value</b>			<b>Unit</b>
		<i>min</i>	<i>typ</i>	<i>max</i>	
$V_{T0}$	<b>Threshold voltage</b>			<b>0.890</b>	<b>V</b>
$r_T$	<b>Forward slope resistance</b> $I_F = 2000 \div 6000 \text{ A}$			<b>0.170</b>	<b>m<math>\Omega</math></b>
$V_{FM}$	<b>Maximum forward voltage</b> $I_{FM} = 4\,000 \text{ A}$			<b>1.650</b>	<b>V</b>
$Q_{rr}$	<b>Recovered charge</b> $V_R = 100 \text{ V, } I_{FM} = 2\,000 \text{ A, } di_F/dt = -5 \text{ A}/\mu\text{s}$		<b>2 550</b>		<b><math>\mu\text{C}</math></b>

Unless otherwise specified  $T_j = 160 \text{ }^\circ\text{C}$

<b>Thermal Parameters</b>		<b>Value</b>	<b>Unit</b>	
$R_{thjc}$	<b>Thermal resistance junction to case</b>	<i>double side cooling</i>	<b>20</b>	<b>K/kW</b>
		<i>anode side cooling</i>	<b>34</b>	
		<i>cathode side cooling</i>	<b>48</b>	
$R_{thch}$	<b>Thermal resistance case to heatsink</b>	<i>double side cooling</i>	<b>5</b>	<b>K/kW</b>
		<i>single side cooling</i>	<b>10</b>	

ABB s.r.o., Novodvorska 1768/138a, 142 21 Praha 4, Czech Republic

ABB s.r.o. reserves the right to change the data contained herein at any time without notice  
TS - D/006/97d Nov-11

**Transient Thermal Impedance**

Analytical function for transient thermal impedance

$$Z_{thjc} = \sum_{i=1}^4 R_i (1 - \exp(-t / \tau_i))$$

Conditions:

$F_m = 22 \pm 2$  kN, Double side cooled

<i>i</i>	1	2	3	4
$R_i$ (K/kW)	11.83	4.26	1.63	2.28
$\tau_i$ (s)	0.432	0.071	0.01	0.0054

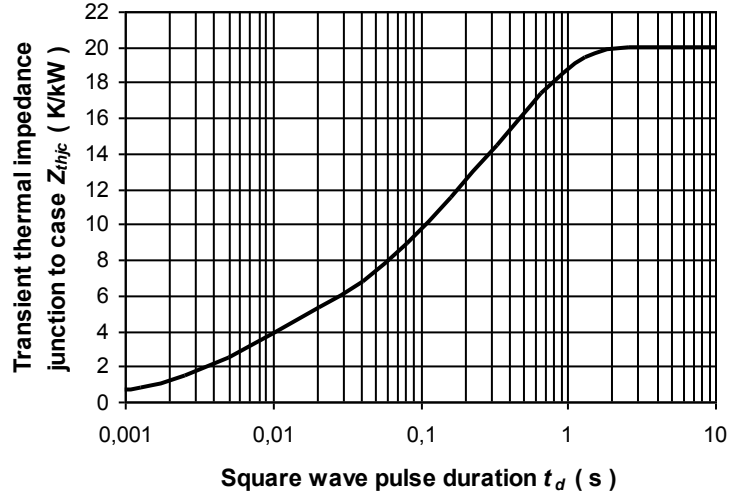

Fig. 2 Transient thermal impedance junction to case

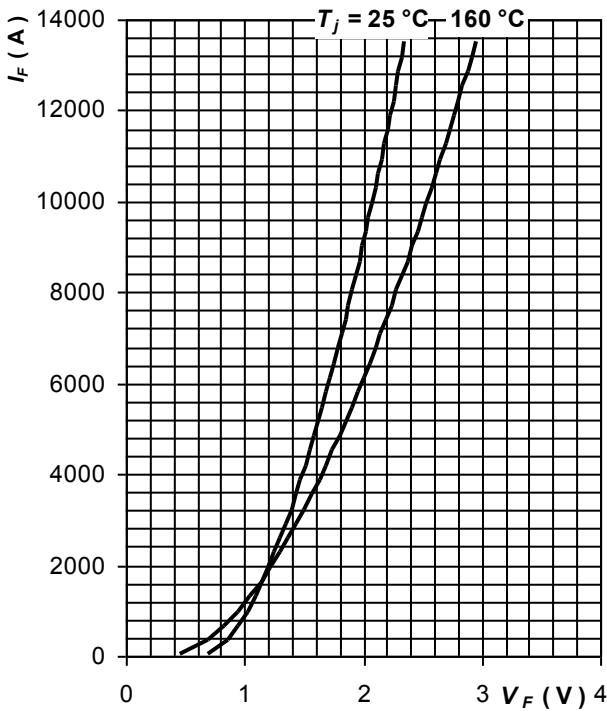

Fig. 3 Maximum forward voltage drop characteristics

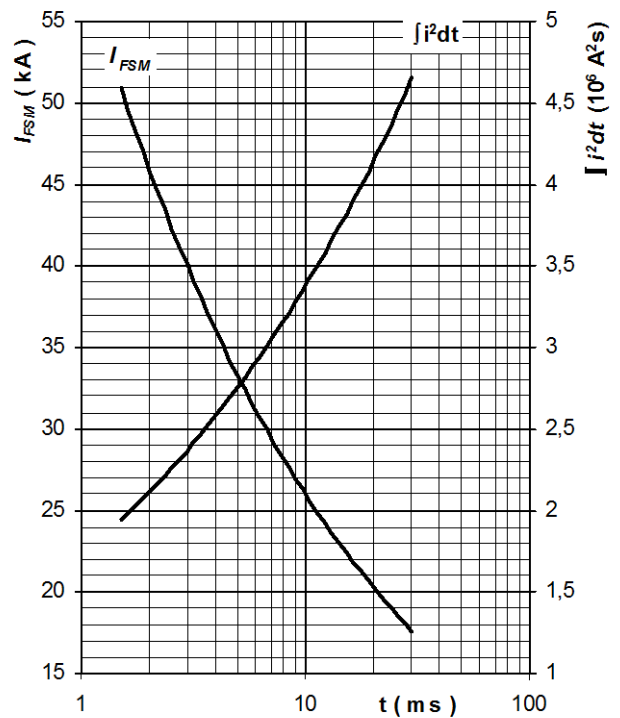

Fig. 4 Surge forward current vs. pulse length, half sine wave, single pulse,  $V_R = 0$  V,  $T_j = T_{jmax}$

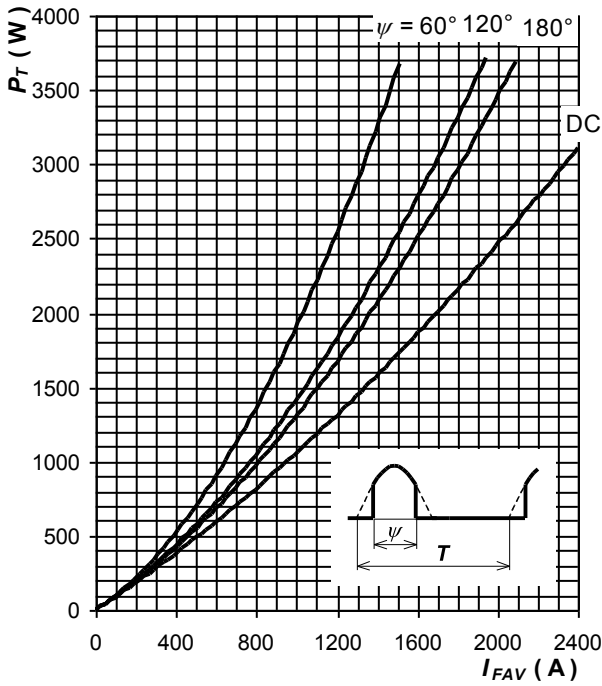

Fig. 5 Forward power loss vs. average forward current, sine waveform,  $f = 50 \text{ Hz}$ ,  $T = 1/f$

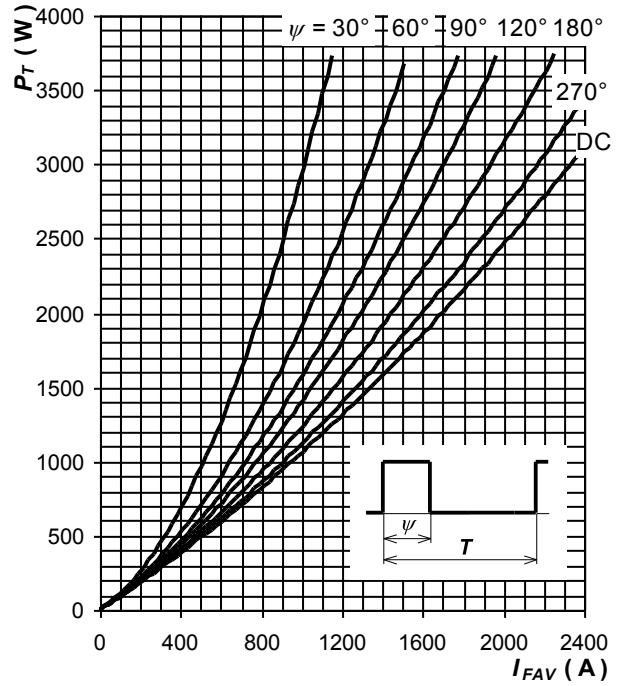

Fig. 6 Forward power loss vs. average forward current, square waveform,  $f = 50 \text{ Hz}$ ,  $T = 1/f$

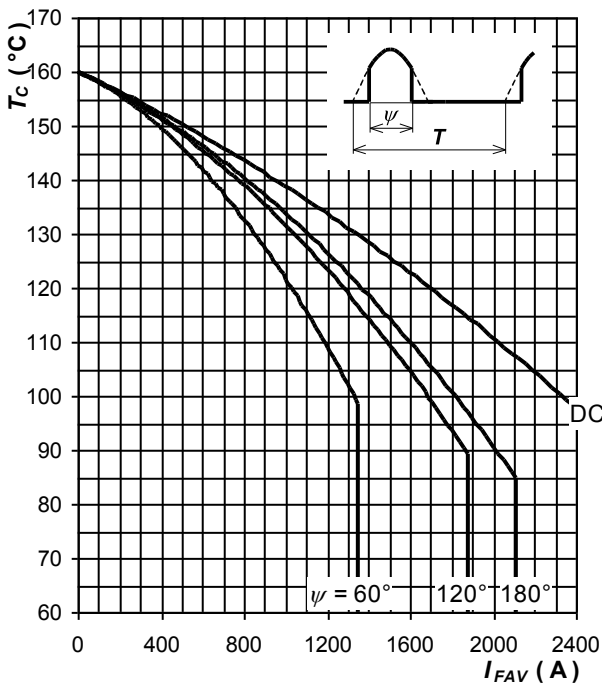

Fig. 7 Max. case temperature vs. aver. forward current, sine waveform,  $f = 50 \text{ Hz}$ ,  $T = 1/f$

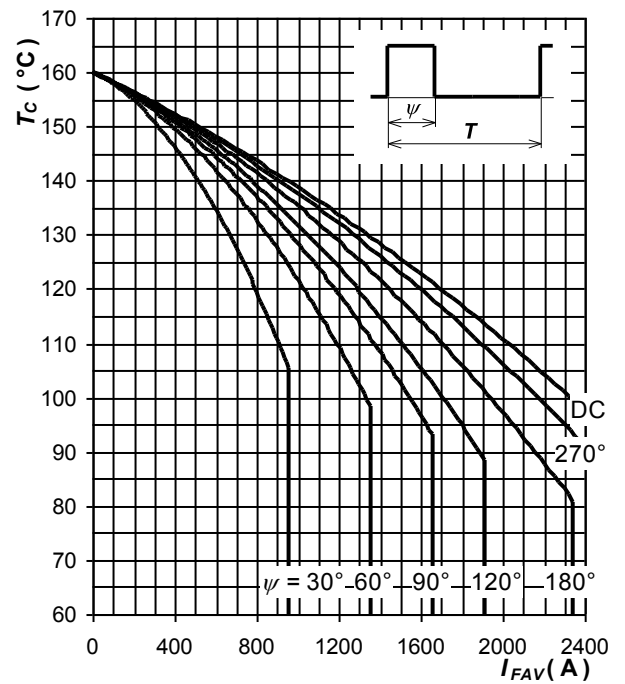

Fig. 8 Max. case temperature vs. aver. forward current, square waveform,  $f = 50 \text{ Hz}$ ,  $T = 1/f$

Notes:

ABB s.r.o., Novodvorska 1768/138a, 142 21 Praha 4, Czech Republic

ABB s.r.o. reserves the right to change the data contained herein at any time without notice