



5SDA 14F5007

Old part no. DA 808-1410-50

Avalanche Diode

Properties

- low on-state voltage
- avalanche reverse characteristics
- high operational reliability
- suitable for parallel operation

Key Parameters

V_{RRM}	=	5 000	V
I_{FAVm}	=	1 410	A
I_{FSM}	=	17 500	A
V_{TO}	=	1.130	V
r_T	=	0.440	m Ω

Types

	V_{RRM}
5SDA 14F5007	5 000 V
5SDA 14F4407	4 400 V
Conditions: $T_j = -40 \div 160$ °C, half sine waveform, $f = 50$ Hz	

Mechanical Data

F_m	Mounting force	22 ± 2 kN
m	Weight	0.46 kg
D_s	Surface creepage distance	30 mm
D_a	Air strike distance	20.5 mm

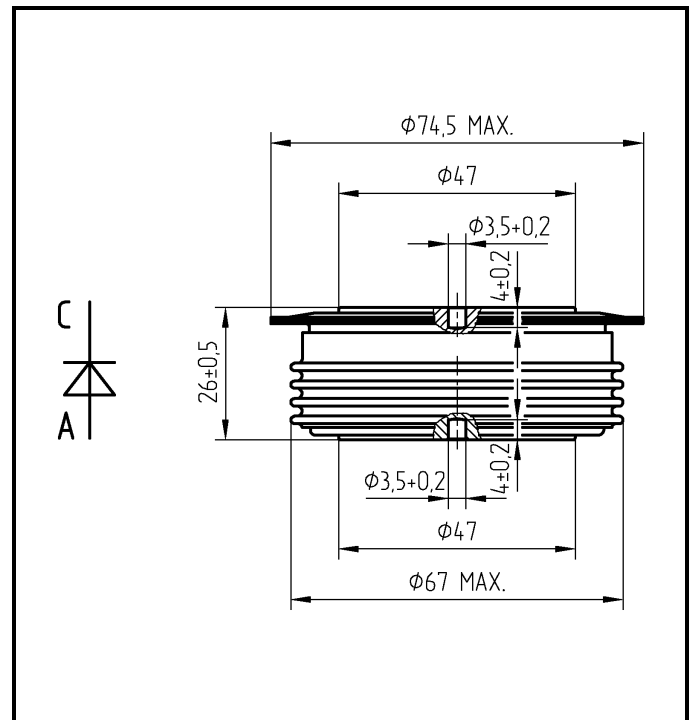

Fig. 1 Case



ABB s.r.o.

Novodvorska 1768/138a, 142 21 Praha 4, Czech Republic

tel.: +420 261 306 250, <http://www.abb.com/semiconductors>

Maximum Ratings			Maximum Limits	Unit
V_{RRM}	Repetitive peak reverse voltage $T_j = -40 \div 160 \text{ }^\circ\text{C}$	5SDA 14F5007 5SDA 14F4407	5 000 4 400	V
I_{FAVm}	Average forward current $T_c = 85 \text{ }^\circ\text{C}$		1 410	A
I_{FRMS}	RMS forward current $T_c = 85 \text{ }^\circ\text{C}$		2 210	A
I_{RRM}	Repetitive reverse current $V_R = V_{RRM}$		50	mA
I_{FSM}	Non repetitive peak surge current $V_R = 0 \text{ V}$, half sine pulse	$t_p = 8.3 \text{ ms}$	18 700	A
		$t_p = 10 \text{ ms}$	17 500	A
I^2t	Limiting load integral $V_R = 0 \text{ V}$, half sine pulse	$t_p = 8.3 \text{ ms}$	1 450 000	A²s
		$t_p = 10 \text{ ms}$	1 531 000	A²s
P_{RSM}	Maximum avalanche power dissipation <i>rectangular pulse 20 μs</i>		50	kW
$T_{jmin} - T_{jmax}$	Operating temperature range		-40 \div 160	$^\circ\text{C}$
T_{STG}	Storage temperature range		-40 \div 160	$^\circ\text{C}$

Unless otherwise specified $T_j = 160 \text{ }^\circ\text{C}$

Characteristics		Value			Unit
		<i>min</i>	<i>typ</i>	<i>max</i>	
V_{TO}	Threshold voltage			1.130	V
r_T	Forward slope resistance $I_F = 1000 \div 3000 \text{ A}$			0.440	mΩ
V_{FM}	Maximum forward voltage $I_{FM} = 4\,000 \text{ A}$			2.880	V
Q_{rr}	Recovered charge $V_R = 100 \text{ V}$, $I_{FM} = 2\,000 \text{ A}$, $di_F/dt = -5 \text{ A}/\mu\text{s}$		4 250		μC

Unless otherwise specified $T_j = 160 \text{ }^\circ\text{C}$

Thermal Parameters			Value	Unit
R_{thjc}	Thermal resistance junction to case	<i>double side cooling</i>	20	K/kW
		<i>anode side cooling</i>	34	
		<i>cathode side cooling</i>	48	
R_{thch}	Thermal resistance case to heatsink	<i>double side cooling</i>	5	K/kW
		<i>single side cooling</i>	10	

ABB s.r.o., Novodvorska 1768/138a, 142 21 Praha 4, Czech Republic

ABB s.r.o. reserves the right to change the data contained herein at any time without notice

Transient Thermal Impedance

Analytical function for transient thermal impedance

$$Z_{thjc} = \sum_{i=1}^4 R_i (1 - \exp(-t / \tau_i))$$

Conditions:

$F_m = 22 \pm 2$ kN, Double side cooled

<i>i</i>	1	2	3	4
R_i (K/kW)	11.83	4.26	1.63	2.28
τ_i (s)	0.432	0.071	0.01	0.0054

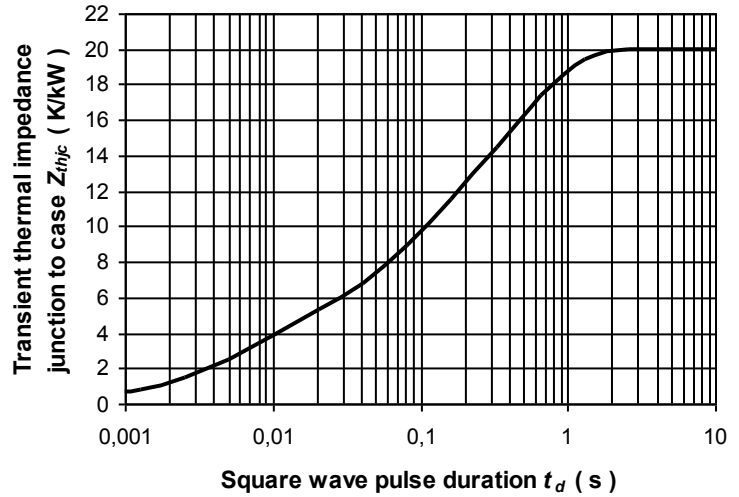

Fig. 2 Transient thermal impedance junction to case

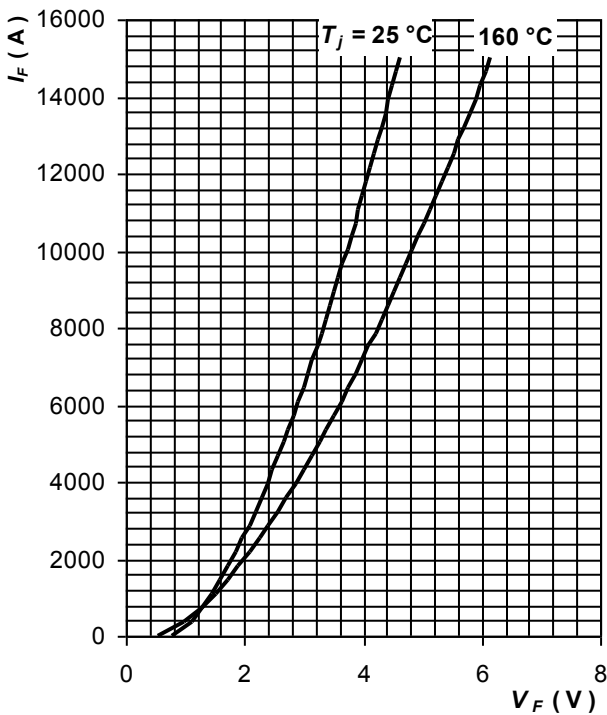

Fig. 3 Maximum forward voltage drop characteristics

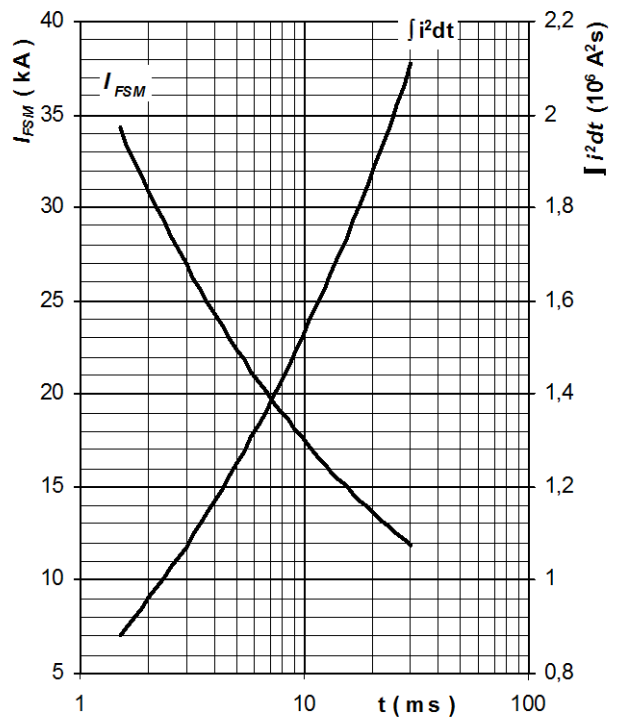

Fig. 4 Surge forward current vs. pulse length, half sine wave, single pulse, $V_R = 0$ V, $T_j = T_{jmax}$

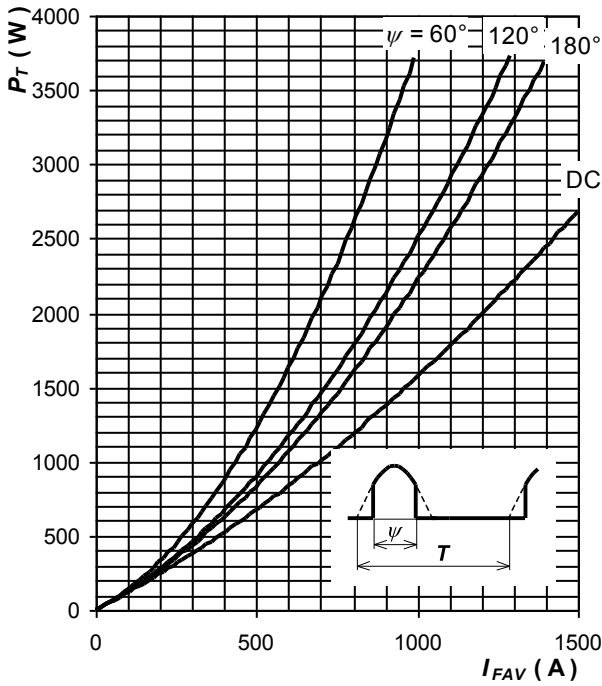

Fig. 5 Forward power loss vs. average forward current, sine waveform, $f = 50 \text{ Hz}$, $T = 1/f$

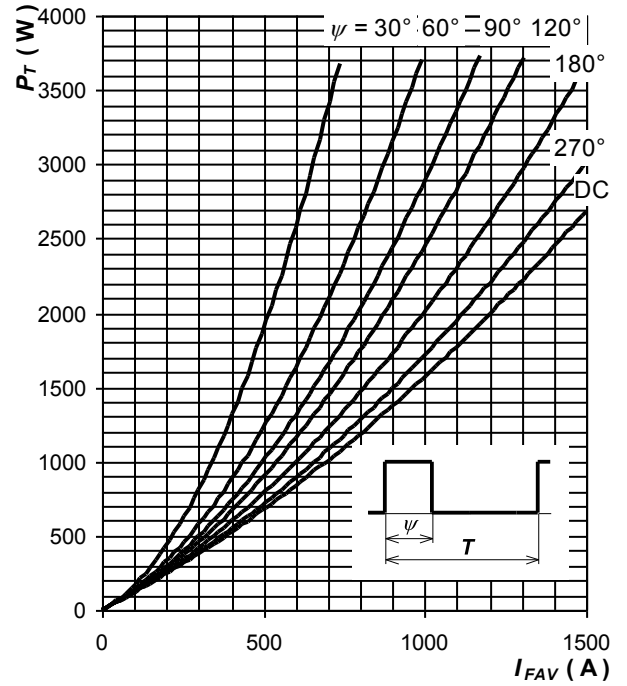

Fig. 6 Forward power loss vs. average forward current, square waveform, $f = 50 \text{ Hz}$, $T = 1/f$

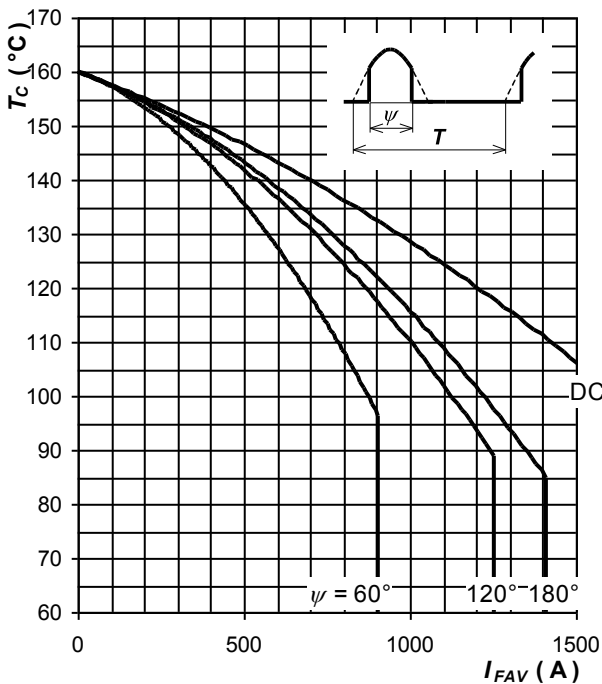

Fig. 7 Max. case temperature vs. aver. forward current, sine waveform, $f = 50 \text{ Hz}$, $T = 1/f$

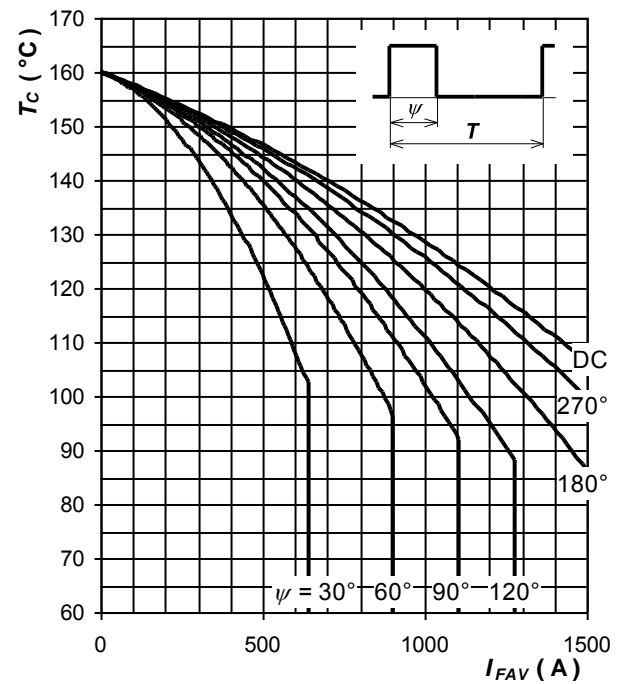

Fig. 8 Max. case temperature vs. aver. forward current, square waveform, $f = 50 \text{ Hz}$, $T = 1/f$

Notes:

ABB s.r.o., Novodvorska 1768/138a, 142 21 Praha 4, Czech Republic

ABB s.r.o. reserves the right to change the data contained herein at any time without notice