



ASSEMBLY AND USE INSTRUCTIONS R5 POWER FACTOR CONTROLLERS



GENERAL DESCRIPTION

The new DUCATI energia R5 is a power factor controller designed to allow a simple and quick installation as well as a correct start of a power factor correction equipment. It is suitable to many applications relating to single-phase and three-phase networks, with or without power generation systems. The R5 models technology allows exchanging system performance and status data both on site - through a Smartphone App - and remotely, for monitoring purposes, through Ducati energia datalogger devices.

MAIN FEATURES

- 5-step power factor automatic controller.
- Display with backlit icons with red LEDs, clearly readable from a distance, 5 navigation keys for functions and settings.
- 868MHz Radio, NFC and RS485 connectivity options.
- Voltage measurement accuracy: 0.2%%±0.5 digit.
- Current measurement accuracy: 1%%±0.5 digit.
- Alarms can be completely defined by the user and associated to relay outputs.

Version D - February 2018

FW reference version: V 0.91 and higher





CONTENTS

1	R5 MODELS	4
2	WARNINGS	4
3	TECHNICAL FEATURES	5
4	INSTALLATION	6
5	CONNECTIONS	7
5.1	BASIC CONNECTIONS	7
5.1.1	Three-phase network without standard neutral with 400V phase-phase voltage.....	7
5.1.2	Three-phase network without neutral in cogeneration with 400V phase-phase voltage.....	8
5.1.3	Other Basic Connections.....	9
5.2	RS485 SERIAL CONNECTION	10
5.3	OUTPUT ALARM CONNECTION.....	10
6	HARDWARE CONFIGURATION AUTO-ACQUISITION AND COMMISSIONING	11
6.1	COMPLETE AUTO-ACQUISITION	11
6.2	REDUCED AUTO-ACQUISITION.....	14
7	SETTINGS.....	16
7.1	CONNECTION SETTINGS.....	17
7.1.1	CT primary winding.....	17
7.1.2	CT secondary winding.....	17
7.1.3	Current reading phase	17
7.1.4	Reversal towards CT.....	17
7.1.5	Cogeneration.....	18
7.1.6	Frequency.....	18
7.1.7	VT primary winding	18
7.1.8	VT secondary winding.....	19
7.1.9	Voltage reading phase.....	19
7.2	EQUIPMENT SETTINGS.....	20
7.2.1	Capacitor nominal voltage.....	20
7.2.2	Manual power factor correction mode.....	20
7.2.3	Re-connection time.....	21
7.2.4	Switching manoeuvre time	21
7.2.5	Step n function (n=1,2,3,4,5).....	21
7.2.6	Step n power (n=1,2,3,4,5).....	22
7.2.7	Alarm n (n=1,2,3,4,5)	23
7.3	POWER FACTOR CORRECTION SETTINGS.....	25
7.3.1	Cosphi setpoint.....	25
7.3.2	Cosphi setpoint tolerance.....	25
7.3.3	Average measurement time	25
7.4	COMMUNICATION INTERFACE SETTINGS	26
7.4.1	Protocol.....	26
7.4.2	Address.....	26
7.4.3	Baudrate.....	26
7.5	ALARM SETTINGS.....	27
7.5.1	Overvoltage alarm threshold	27
7.5.2	Overvoltage alarm delay.....	27
7.5.3	Overcurrent alarm threshold	27
7.5.4	Overcurrent alarm delay.....	28
7.5.5	Low voltage alarm threshold.....	28
7.5.6	Low voltage alarm delay.....	29
7.5.7	Low current alarm threshold.....	29
7.5.8	Low current alarm delay.....	29
7.5.9	THDV alarm threshold.....	30
7.5.10	THDV alarm delay	30
7.5.11	THDI alarm threshold.....	30
7.5.12	THDI alarm delay	31
7.5.13	Temperature alarm threshold.....	31
7.5.14	Temperature alarm delay.....	31



7.6	ADVANCED SETTINGS	32
7.7	PARAMETER DEFAULT RANGE AND VALUES	32
7.8	NUMERICAL VALUE ENTERING MODES	35
8	USING THE CONTROLLER	36
8.1	CONTROLLER INFORMATION	36
8.1.1	<i>Model and Serial Number</i>	36
8.1.2	<i>Firmware Version</i>	36
8.2	DISPLAY AND KEY DESCRIPTION	37
8.2.1	<i>Display</i>	37
8.2.2	<i>Key functions</i>	38
8.3	MEASUREMENT MENU	39
8.4	STATISTICS MENU	41
8.4.1	<i>Capacitor bank statistics</i>	41
8.4.2	<i>Alarm statistics</i>	42
8.5	ALARM MANAGEMENT AND DISPLAY	45
8.5.1	<i>Current alarm menu</i>	45
8.5.2	<i>Alarm description</i>	48
8.5.2.1	<i>Overvoltage alarm</i>	48
8.5.2.2	<i>Overcurrent alarm</i>	49
8.5.2.3	<i>Low voltage alarm</i>	49
8.5.2.4	<i>Low current alarm</i>	50
8.5.2.5	<i>THDI alarm</i>	52
8.5.2.6	<i>THDV alarm</i>	52
8.5.2.7	<i>Temperature alarm</i>	53
8.5.2.8	<i>Power factor overcorrection alarm</i>	54
8.5.2.9	<i>Power factor correction failed alarm</i>	55
8.5.2.10	<i>Micro-interruption alarm</i>	56
8.5.2.11	<i>Bank n breakage alarm (n=1,2,3,4,5)</i>	57
8.5.2.12	<i>Maximum number of bank n insertions (n=1,2,3,4,5) alarm</i>	58
8.6	RESET MENU	59
8.6.1	<i>Bank n parameters/statistics reset (n=1,2,3,4,5)</i>	59
8.6.2	<i>Bank n contactor switching manoeuvres number reset (n=1,2,3,4,5)</i>	60
8.6.3	<i>Alarm reset</i>	60
8.6.4	<i>Average value reset</i>	60
8.6.5	<i>Minimum and maximum value reset</i>	60
8.6.6	<i>Auto-acquisition reset</i>	61
8.6.7	<i>Reset to factory settings</i>	61
8.7	COMMUNICATION INTERFACES	62
8.7.1	<i>RS485 serial connection</i>	62
8.7.2	<i>868Mhz Radio Interface</i>	62
8.7.3	<i>NFC</i>	62
8.8	MANUAL POWER FACTOR CORRECTION MODE	63
8.9	PRESENCE OF BLOCKING REACTORS	64
8.10	FIRMWARE UPDATE	65
9	APPENDIX - MENU NAVIGATION	66



1 R5 MODELS

Models	Part Numbers	NFC	RS485	RADIO 868MHz	no. of STEPS	On DUCATI Energia panels
R5 POWER FACTOR CONTROLLER	415984050NNNN	✓			5	
R5 485 POWER FACTOR CONTROLLER	415984050QNNN	✓	✓		5	
R5 RADIO POWER FACTOR CONTROLLER	415984050NNDN	✓		✓	5	
R5 485 RADIO POWER FACTOR CONTROLLER	415984050QNDN	✓	✓	✓	5	
R5 INT POWER FACTOR CONTROLLER	315984060NNNN	✓			5	✓
R5 485 INT POWER FACTOR CONTROLLER	315984060QNNN	✓	✓		5	✓
R5 RADIO INT POWER FACTOR CONTROLLER	315984060NNDN	✓		✓	5	✓
R5 RADIO 485 INT POWER FACTOR CONTROLLER	315984060QNDN	✓	✓	✓	5	✓

Refer to **Chap. 3 - TECHNICAL FEATURES** for the details on the options listed in the table

GO BACK TO **CONTENTS**

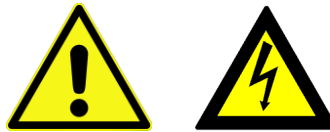

2 WARNINGS

Carefully read this guide before using the power factor controller
The purpose of this guide is to provide the information to install and start using the models of the range of R5 power factor controllers.
The device must be installed and wired by qualified personnel.
An automatic switch or a disconnecter must be integrated with the electric system, duly positioned near the controller, and easily accessible by the operator. It must be marked as equipment disconnecting device: IEC/EN 61010-1 § 6.11.2
Risk of electrocution, burns and electric arc. Obtain the personal protective equipment appropriate to fulfil the current electrical safety standards.
Before making the connections, check the power supply disconnection with a voltage detection device that must be placed close to the power factor controller or, however, be easily accessed by the operator.
If necessary, clean the instrument using only a damp cloth.
The updated version of this manual and the complete operating manual are available on line at the link https://www.ducatienergia.com/product.php?lang=en&id=8&cat=13&product=89

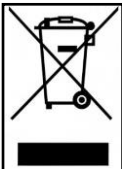

Do not dispose of the device as mixed municipal waste



The manufacturer, Ducati energia S.p.A. declares that R5 Controllers comply with the 2014/53/EU directive.
 The complete text of the EU declaration of conformity is available at the following internet address:
<https://www.ducatienergia.com/product.php?lang=en&id=8&cat=13&product=89>



GO BACK TO **CONTENTS**



3 TECHNICAL FEATURES

- **Power supply:**
 - Nominal voltage: 400 or 230 V~
 - Operating limits: 380÷415 V~ ±10% or 220÷240 V~ ±10%
 - Frequency range: 45-66 Hz
 - Power consumption: 2.5W – 3VA
 - Fuses: Fast 1A
- **Voltage input:**
 - Common terminal to supply input
 - Nominal voltage: 400V~ o 230 V~
 - Measuring range: 342÷457V~ or 198÷264 V~
 - Accuracy: 0.2% ± 0.5 digit
 - Frequency range: 45-66 Hz
 - Measuring type: true RMS (TRMS)
- **Current input:**
 - Input type: current shunt
 - Nominal current: 5A
 - Measuring range: 0.03-6 A~
 - Accuracy: 1% ± 0.5 digit
 - Measuring type: true RMS (TRMS)
 - Input consumption: <1.8VA
- **Relay outputs:**
 - Number of outputs: 5 with 1 common
 - Contact type: NO (Normally open)
 - Maximum switching voltage: 440V~
 - Nominal capacity: AC1 6A–250V~, AC15 1,5A-440V~
 - Mechanical/electrical life: > 30x10⁶ / > 2x10⁵ switching manoeuvres
- **Environmental conditions:**
 - Operating temperature: -20 to +70°C
 - Storage temperature: -30 to +80°C
 - Overvoltage category: III
 - Measuring category: 3
 - Insulation voltage: 600V~
 - Relative humidity: < 80%
- **Connection terminals:**
 - Type: removable
 - Cable section: 0.2-2.5 mm² (24-12 AWG)
 - Tightening torque: 0.5 Nm
 - Stripping length: 7 mm
- **Enclosure:**
 - Size: 96x96 recessed
 - Material: PBT thermoplastic polyester
 - Protection degree: IP51 on the front side – IP20 on the terminals
 - Weight: 350g.
- **RS485 Interface:**
 - Insulation voltage: 600V~
 - Protocols: Modbus-RTU, Ascii-Ducbus
 - Baud rate: 9600-115200 bps
 - Termination resistance: 120Ohm – integrated (activated with external jumper)
- **13.56Mhz NFC interface:**
 - Data exchange with Smartphone through the antenna located behind the display – use Android app *Ducati Smart Energy*. <https://play.google.com/store/apps/details?id=it.ducatienergia.smartenergy>
- **868Mhz Radio interface:**
 - Carrier frequency: 868MHz
 - Frequency range: 868.0 – 868.6 MHz
 - Maximum emitted power: 12.5mW
 - Protocol: Modbus
- **Compliance with standards:**

EN 61010-1, EN 61000-6-2, EN 61000-6-4, EN 61326-1, EN 62311, EN 301-489-1, EN 301-489-3, EN 300-220-2, EN 300-330

GO BACK TO **CONTENTS**

4 INSTALLATION

The controller must be installed on a vertical panel on which a square opening in compliance with IEC 61554 standard has been previously made. Opening dimensions must be 92.0mm x 92.0mm, with a permitted tolerance of +0.8mm and -0mm.

Insert **1** controller from panel front side and secure it **2** at the back with the 4 supplied retaining clips, letting them slide fully home against panel rear wall.

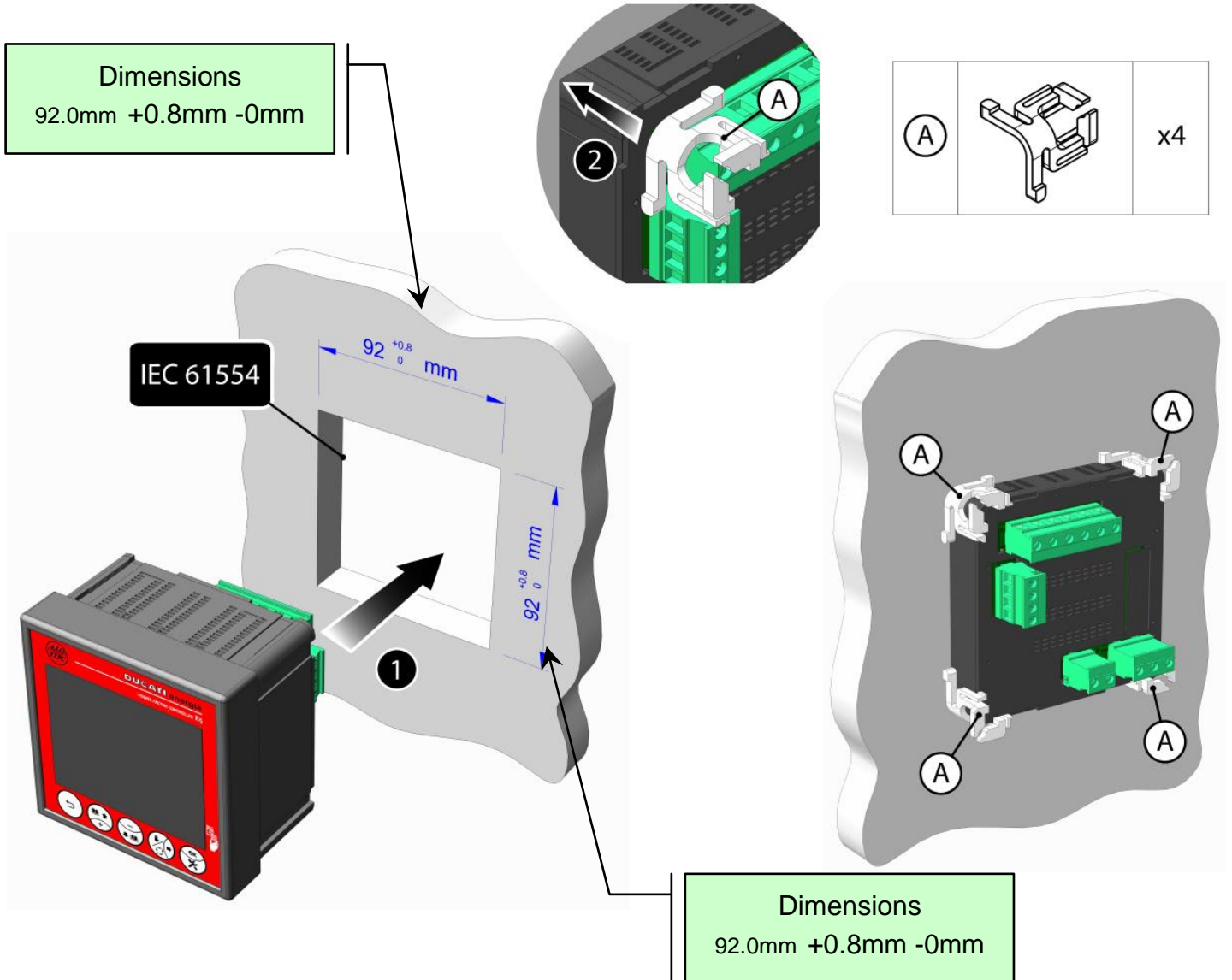

For flying connector wiring, refer to [Chap. 5 - CONNECTIONS](#).

GO BACK TO [CONTENTS](#)

5 CONNECTIONS

For voltage/supply input, current input and relay output connections

GO TO [Chap. 5.1 - Basic Connections](#)

For the connections to the serial communication port

GO TO [Chap. 5.2 - RS485 serial connection](#)

For the connections of the output relays used as alarm contacts

GO TO [Chap. 5.3 - Alarm output connections](#)

GO BACK TO [CONTENTS](#)

5.1 Basic Connections

5.1.1 Three-phase network without standard neutral with 400V phase-phase voltage

Connect the R5 controller as indicated in the figure below.

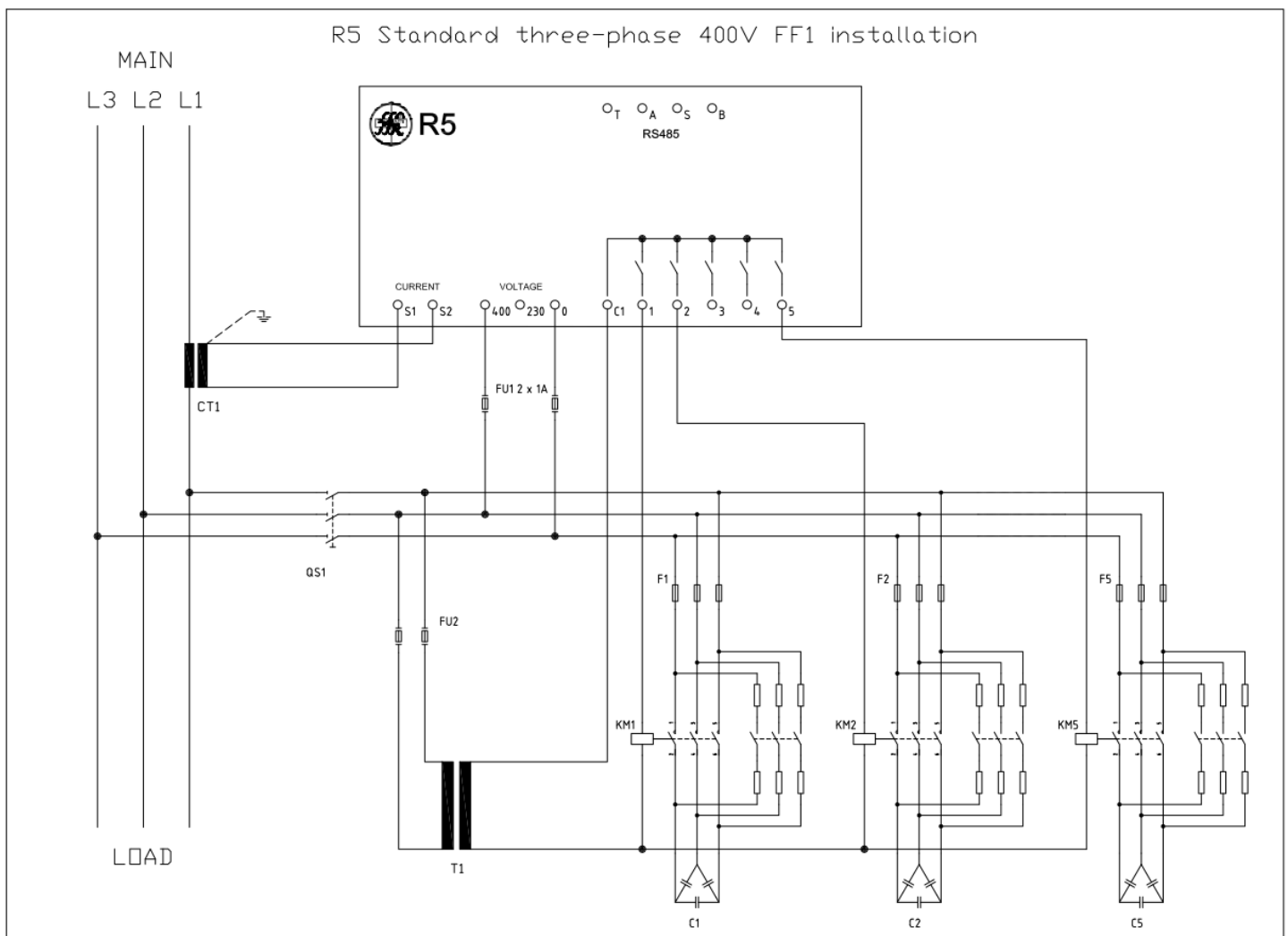

NOTE: the diagram shows a FF1 configuration, for FF2 and FF3 configurations, refer to the complete operating manual, available at the following link: <https://www.ducatienergia.com/product.php?lang=en&id=8&cat=13&product=89>

Connect all the available power factor correction banks using terminals from 1 to 5, as indicated for banks 1, 2 and 5.

For the components indicated in the figure (CT1, F1..5, FU2, T1, KM1..5, C1..5 and QS1), refer to the power factor correction equipment manual and to the manual of the system on which the power factor controller is fitted.

CAUTION: At first power-up of the system, if on the amperometric input there is a current exceeding 0.7% of the **CT secondary wiring** [Chap. 7.1.2](#) the auto-acquisition procedure will be automatically performed based on one of the methods specified in [Chap. 6](#). This procedure requires the essential parameters necessary for the first commissioning.

WARNING: If you want or if you need to edit the default parameters before auto-acquisition, do not connect the current signal to controller (CURRENT terminals), or make sure that the current reading is equal to zero.

Then set parameters through the [Setup Menu](#) consistently with the indications given in [Chap. 7.7](#).

NOTE 1: in case of blocking reactors, refer to the indications given in [Chap. 8.9 - Presence of blocking reactors](#).

NOTE 2: the **Re-connection time** parameter must be set consistently with the indications given in the power factor correction equipment manual. WARNING: Entering a time shorter than the recommended one can lead to equipment and/or controller damage.

It is always possible to edit parameters even after the auto-acquisition and/or to repeat this latter using the **Auto-acquisition reset functions** ([Chap. 8.6.6](#)) and **Reset to factory settings** ([Chap. 8.6.7](#)).

GO BACK TO [CONNECTIONS](#)

GO BACK TO [CONTENTS](#)

5.1.2 Three-phase network without neutral in cogeneration with 400V phase-phase voltage

Connect the R5 controller as indicated in the figure below.

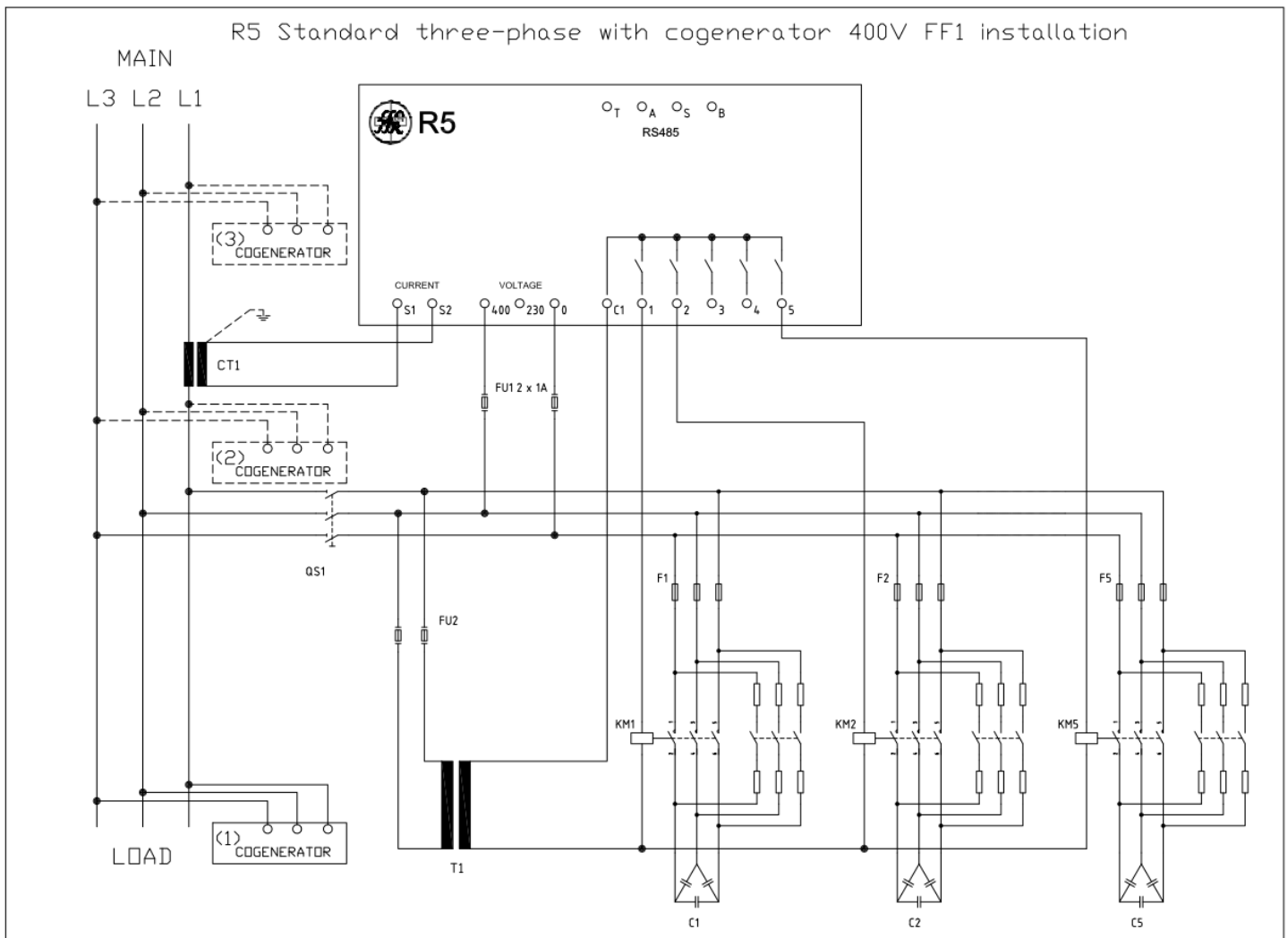

NOTE: the diagram shows a FF1 configuration, for FF2 and FF3 configurations, refer to the complete operating manual, available at the following link: <https://www.ducatienergia.com/product.php?lang=en&id=8&cat=13&product=89>



Connect all the available power factor correction banks using terminals from 1 to 5, as indicated for banks 1, 2 and 5.

For the components indicated in the figure (CT1, F1..5, FU2, T1, KM1..5, C1..5 and QS1), refer to the power factor correction equipment manual and to the manual of the system on which the power factor controller is fitted.

As an alternative, the cogeneration system (COGENERATOR) can be connected in one of the three positions (1), (2) and (3) shown in the figure. If the installation is made in points (1) or (2), the controller will also correct the power factor of the cogeneration system and the cogeneration operating mode will have to be enabled. If the installation is made in point (3), the controller will not correct the power factor of the cogeneration system, hence the relevant operation mode will not have to be enabled. For equipment installation, refer to the relevant manual.

CAUTION: At first power-up of the system, if on the amperometric input there is a current exceeding 0.7% of the **CT secondary wiring** [Chap. 7.1.2](#) the auto-acquisition procedure will be automatically performed based on one of the methods specified in [Chap. 6](#). This procedure requires the essential parameters necessary for the first commissioning. If you wish to perform this procedure, **turn off the cogeneration systems**.

Once the auto-acquisition procedure is completed, turn on again the cogeneration systems and set the **Cogeneration** parameter to "ON" if the cogeneration system is in (2) or (1). For further details, refer to [Chap. 7.1.5 - Cogeneration](#).

WARNING: If you want or if you need to edit the default parameters before auto-acquisition, do not connect the current signal to controller (CURRENT terminals), or make sure that the current reading is equal to zero.

Then set parameters through the **Setup Menu** consistently with the indications given in [Chap. 7.7](#).

NOTE 1: in case of blocking reactors, refer to the indications given in [Chap. 8.9 - Presence of blocking reactors](#).

NOTE 2: the **Re-connection time** parameter must be set consistently with the indications given in the power factor correction equipment manual. **WARNING:** Entering a time shorter than the recommended one can lead to equipment and/or controller damage.

It is always possible to edit parameters even after the auto-acquisition and/or to repeat this latter using the **Auto-acquisition reset functions** ([Chap. 8.6.6](#)) and **Reset to factory settings** ([Chap. 8.6.7](#)).

GO BACK TO [CONNECTIONS](#)

GO BACK TO [CONTENTS](#)

5.1.3 Other Basic Connections

Other connections can be made based on network configuration. The controller and the controlled power factor correction equipment can be connected to the following networks:

- Standard, single phase, with phase-neutral voltage at 230Vac or 400Vac, with or without VT;
- Cogeneration, single-phase, with phase-neutral voltage at 230Vac or 400Vac, with or without VT;
- Three-phase, with standard neutral with phase-neutral voltage at 230Vac or 400Vac, with or without VT;
- Three-phase with neutral in co-generation with phase-neutral voltage at 230Vac or 400Vac, with or without VT;
- Three-phase without standard neutral with phase-neutral voltage at 230Vac, with or without VT;
- Three-phase without neutral in co-generation with phase-neutral voltage at 230Vac, with or without VT.

For this type of connections, refer to the complete operating manual, available at the following link:

<https://www.ducatienergia.com/product.php?lang=en&id=8&cat=13&product=89>

GO BACK TO [CONNECTIONS](#)

GO BACK TO [CONTENTS](#)

5.2 RS485 serial connection

For the models featuring the RS485 serial port, connect the signal as indicated in the figure below, taking into account that the positive signal must be connected to pin A and the negative signal to pin B.

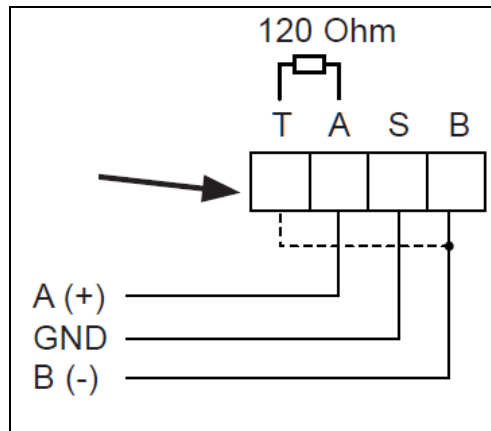

By short-circuiting pin B across pin T, the line can be terminated with a 120 Ohm resistance, already present inside the electronics.

For detailed information on protocol, address and baud rate parameter settings, refer to **Chap. 7.4 - Communication interface settings**.

For detailed information on Modbus-RTU and ASCII Ducbus protocol specifications, refer to the documents available at the following link: ftp://ftp.ducatienergia.com/DucatiSistemi/Protocols_Analysers/

GO BACK TO **CONNECTIONS**

GO BACK TO **CONTENTS**

5.3 Output alarm connection

Relay outputs can be connected as alarm outputs. For detailed information on how to configure an output as alarm, refer to **Chap. 7.3 - Power factor correction settings**.

The figure below shows how to connect output 1.

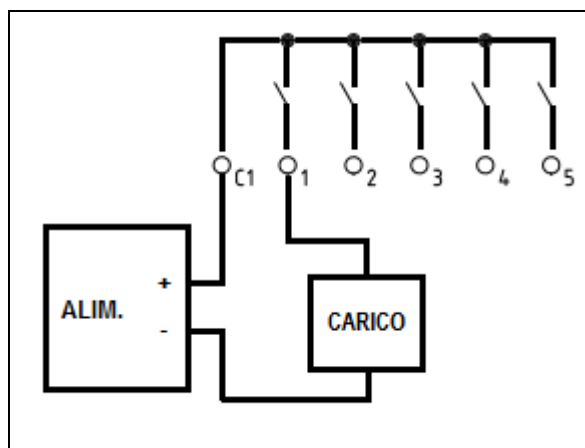

The contact is in NO (normally open) logic, and it closes if the output-associated alarm is activated.

The power supply unit (PWR) and the reading electronics (LOAD) must comply with the indications provided in the technical features of relay outputs in **Chap. 3 - TECHNICAL FEATURES**.

GO BACK TO **CONNECTIONS**

GO BACK TO **CONTENTS**

6 HARDWARE CONFIGURATION AUTO-ACQUISITION AND COMMISSIONING

For the description and execution method of a complete auto-acquisition (of phase, CT direction and powers of each bank)

GO TO [Chap. 6.1 - Complete auto-acquisition](#)

For the description and execution method of a reduced auto-acquisition (of phase and CT direction)

GO TO [Chap. 6.2 - Reduced auto-acquisition](#)

GO BACK TO [CONTENTS](#)

6.1 Complete auto-acquisition

Here below is the **complete acquisition** procedure applying to R5 controllers on which:

- factory settings have not been modified (NOTE: R5 Controllers installed on Ducati Energia or third party equipment do not have to be considered as factory-set);
- a **Reset to factory settings** procedure has just been carried out [Chap. 8.6.7](#)
- all **Step n power (n=1,2,3,4,5)** parameters are equal to zero and an **Auto-acquisition reset** procedure has just been performed [Chap. 8.6.6](#)



1.) ↘

At first system power-up or at power-up after a restart forced by the reset procedure, the R5 Controller performs an automatic insertion of capacitor banks to check the connections and the amount of bank power.

In order to properly perform these initial checks, you must:

- turn off any generation plants (if present);
- make sure the system load is stable and that the current measured by the controller is not a non-zero current and 0.7% higher than the **CT secondary winding** parameter [Chap. 7.1.2](#).

2.) ↘

Before checking the connections, the controller will show the setting screens of the values of

- **CT primary winding** (fig. 1a, 1b) (to enter the numerical value, refer to [Chap. 7.1.1](#));
- **CT secondary winding** (fig. 2a, 2b) (to enter the numerical value, refer to [Chap. 7.1.2](#));
- **Capacitor nominal voltage** (fig. 3a and 3b) (to enter the numerical value, refer to [Chap. 7.2.1](#)).

With no input current, the Controller will not show these screens and:

- will move to the cosphi measurement page showing “---”.
- the controller will also indicate the signals relating to the **low current alarm** [Chap. 8.5.2.4](#).

Under these circumstances:

- it is anyway possible to access the Setup Menu [Chap. 7 - SETTINGS](#) in order to pre-set the operating parameters. If in this phase even just one of the **Step n power (n=1,2,3,4,5)** parameters is modified, when the Controller will measure a stable non-zero current, a **Reduced auto-acquisition** procedure will be performed [Chap. 6.2](#);
- it is anyway possible to move to the **Manual power factor correction mode** [Chap. 8.8](#) to manually insert the banks;

When the controller will measure a stable non-zero current, it will show the setting pages of **CT primary winding**, **CT secondary winding** (fig. 1a, 1b, 2a and 2b) and **Capacitor nominal voltage** (fig. 3a and 3b).

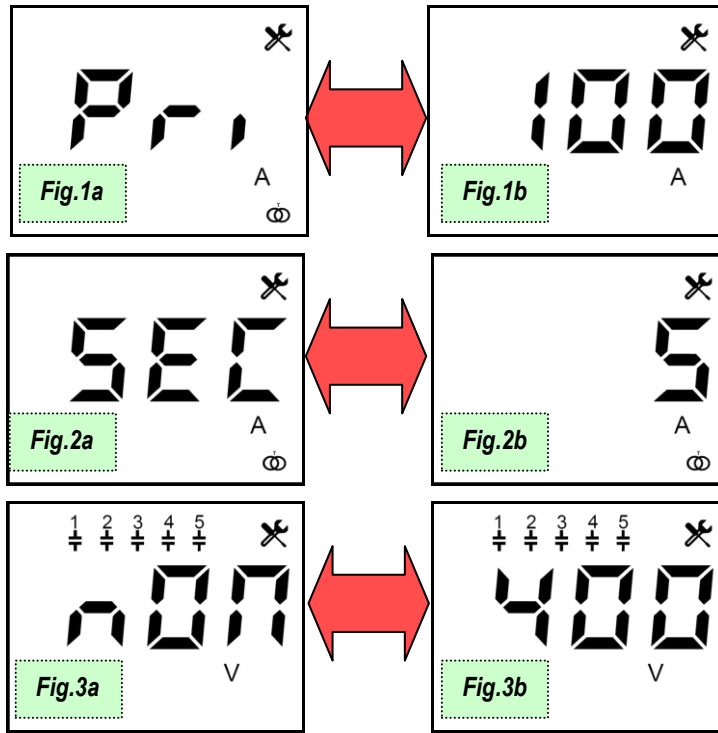

	Shift to the screen of the previous parameter / Cancel current change
	Change Value of CT Primary (Pri) winding or CT secondary (SEC) winding or Capacitor nominal voltage (nOM) / Increment value of selected digit
	Change Value of CT Primary (Pri) winding or CT secondary (SEC) winding or Capacitor nominal voltage (nOM) / Decrement value of selected digit
	Select next digit during parameter change
	Confirm value and pass to the screen of the next parameter

3.) ↘

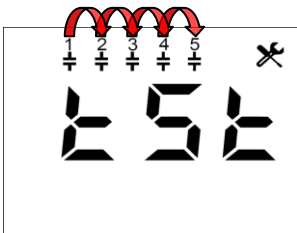

After setting the values of **CT primary winding**, **CT secondary winding** and **Capacitor nominal voltage**, the controller will check the voltage/current connections by cyclically inserting the capacitor banks. After each insertion, the controller will show the calculated configuration for a few seconds. A minimum of 2 to a maximum of 5 cycles of insertion cycles are needed, at the end of which the controller will automatically set the type of detected connection. The duration of a cycle is equal to the greatest value between one minute and the value of the **Re-connection time** parameter [Chap. 7.2.3](#).

Should the controller not be able to automatically define the type of configuration due to unfavourable load conditions, it will show the setting screen of parameter **Current reading phase** [Chap. 7.1.3](#) that will have to be manually entered (or confirmed).

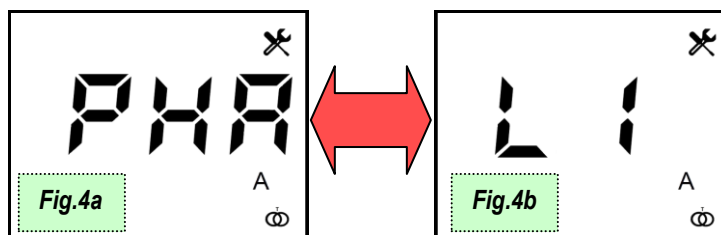



	Screen of the previous parameter / Cancel current change
	Change current phase connected to controller
	Change current phase connected to controller
	Go to the next parameter screen
	Confirm current phase and go to the screen of the next parameter

4.) ↘

After checking the connections, the controller will show the screens of reactive power estimated values for each bank (parameter **Step n power (n=1,2,3,4,5)**): it is possible to confirm or modify the values to finish the boot process and to display the measured cosphi.

Note: for the banks with unstable power measurement (generally due to a load that varies quickly during the procedure) the 0 kVAr value will be suggested.

WARNING: an unstable load during self-acquisition alters the calculated value considerably. If the values differ from those specified in the documents (or on the plate) of the power factor correction equipment, edit them by entering the reactive power values at bank nominal voltage.

In case of blocking reactors, refer to **Chap. 8.9 - Presence of blocking reactors.**

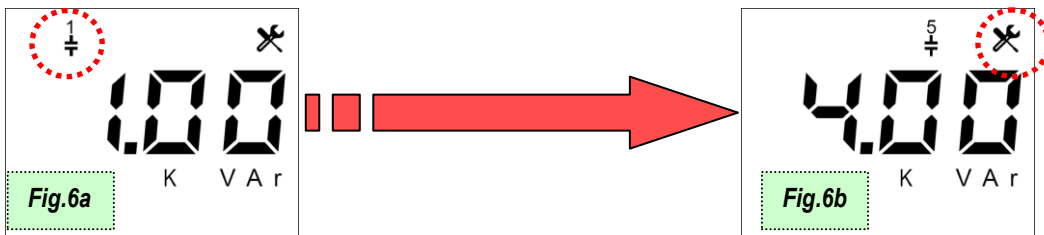

	Screen of the previous parameter / Cancel current change
	Change nominal voltage or reactive power of the capacitor banks / Increment value of selected digit
	Change nominal voltage or reactive power of the capacitors banks / Decrement value of selected digit
	Go to the next parameter screen
	Confirm nominal voltage or power of the capacitors banks and go to the screen of the next parameter

5.) ↘

Once finished, the controller will move to the first page of the Measurement Menu by displaying the cosphi value.

Any generation plants present can be turned on; in this case set the **Cogeneration** parameter = "ON" from the Setup Menu **Chap. 7 - SETTINGS.**

GO BACK TO **HARDWARE CONFIGURATION AUTO-ACQUISITION AND COMMISSIONING**

GO BACK TO **CONTENTS**

6.2 Reduced auto-acquisition

Here below is the **reduced acquisition** procedure applying to R5 Controllers:

- whose factory settings have been modified according to the procedure described in **Chap. 5 - CONNECTIONS** and on which no previous auto-acquisition has been performed;
- that are installed on Ducati Energia equipment and are powered on for the first time;
- have at least one of the **Step n power (n=1,2,3,4,5)** parameters not equal to zero and on which a **Auto-acquisition reset** procedure has just been performed **Chap. 8.6.6**.



1.) ↘

At first system power-up or at power-up after a restart forced by the reset procedure, the R5 Controller performs an automatic insertion of capacitor banks to check the connections and the amount of bank power.

In order to properly perform these initial checks, you must:

- **turn off** any generation plants (if present);
- make sure the system load is **stable** and that the current measured by the controller is not a **non-zero** current and 0.7% higher than the **CT secondary winding** parameter **Chap. 7.1.2**.

2.) ↘

Before checking the connections, the controller will show the setting screens of the values of

- **CT primary winding** (fig. 1a, 1b) (to enter the numerical value, refer to **Chap. 7.1.1**);
- **CT secondary winding** (fig. 2a, 2b) (to enter the numerical value, refer to **Chap. 7.1.2**);

With no input current, the Controller will not show these screens and:

- will move to the cosphi measurement page showing “---”.
- the controller will also indicate the signals relating to the **low current alarm** **Chap. 8.5.2.4**.

Under these circumstances:

- it is anyway possible to access the **Setup Menu** **Chap. 7 - SETTINGS** in order to pre-set the operating parameters. If in this phase even just one of the **Step n power (n=1,2,3,4,5)** parameters is modified, when the Controller will measure a stable non-zero current, a **Reduced auto-acquisition** procedure will be performed **Chap. 6.2**;
- it is anyway possible to move to the **Manual power factor correction mode** **Chap. 8.8** to manually insert the banks;

When the controller will measure a stable non-zero current, it will show the setting pages relating to **CT primary winding** and **CT secondary winding** (fig. 1a, 1b, 2a and 2b)

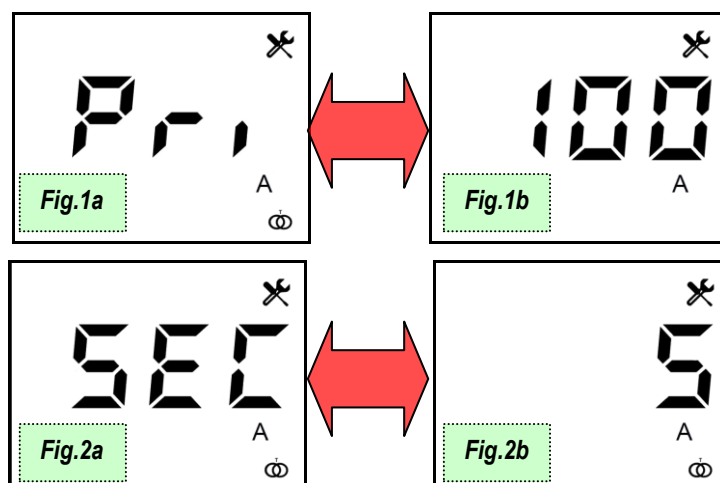



	Shift to the screen of the previous parameter / Cancel current change
	Change Value of CT Primary (Pri) winding or CT secondary (SEC) winding / Increment value of selected digit
	Change Value of CT Primary (Pri) winding or CT secondary (SEC) winding / Decrement value of selected digit
	Select next digit during parameter change
	Confirm value and pass to the screen of the next parameter

3.)

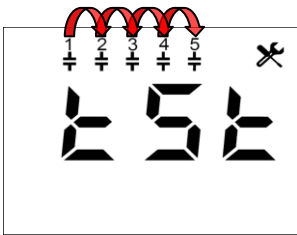

After setting the values of **CT primary winding**, **CT secondary winding** and **Capacitor nominal voltage**, the controller will check the voltage/current connections by cyclically inserting the capacitor banks. After each insertion, the controller will show the calculated configuration for a few seconds. A minimum of 2 to a maximum of 5 cycles of insertion cycles are needed, at the end of which the controller will automatically set the type of detected connection.

The duration of a cycle is equal to the greatest value between one minute and the value of the **Re-connection time** parameter [Chap. 7.2.3](#).

NOTE: the banks for which parameter **Step n power (n=1,2,3,4,5)** is equal to zero are excluded and are not inserted.

Should the controller not be able to automatically define the type of configuration due to unfavourable load conditions, it will show the setting screen of parameter **Current reading phase** [Chap. 7.1.3](#) that will have to be manually entered (or confirmed).

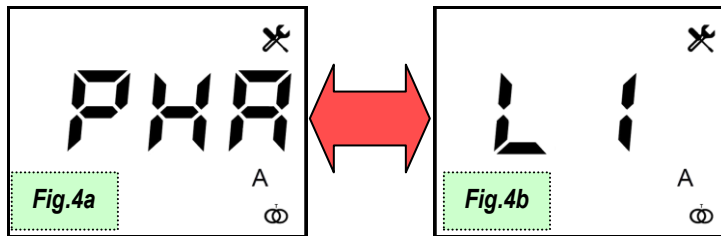

	Screen of the previous parameter / Cancel current change
	Change current phase connected to controller
	Change current phase connected to controller
	Go to the next parameter screen
	Confirm current phase and go to the screen of the next parameter

4.)

Once connection has been checked, the controller will move to the first page of the **Measurement Menu** displaying the cosphi value.

Any generation plants present can be turned on; in this case set the **Cogeneration** parameter = "ON" from the **Setup Menu** [Chap. 7 - SETTINGS](#).

GO BACK TO [HARDWARE CONFIGURATION AUTO-ACQUISITION AND COMMISSIONING](#)





GO BACK TO [CONTENTS](#)

7 SETTINGS

Access the Setup Menu by pressing  for at least 2sec.





The following screen will appear:



Scroll the menu using keys  or  until displaying the desired parameter. To edit parameter, press key  or key , the display will show:

- in case of numerical values: only the value of the current parameter with the selected digit flashing;
- in case of values requiring a pre-defined list: the current value flashing.



In case of numerical values: press keys  or  to increase or decrease the selected digit and press key  to change position. **For numerical value entering modes, refer to [Chap. 7.8 - Numerical value entering modes](#).**

In case of pre-defined list, press keys  or  to scroll the possible values. The change in progress can be cancelled by pressing key . To confirm the parameter, press key .

WARNING: by confirming the parameter, the value will overwrite the previous one.

NOTE: if a numerical value out of range or with a wrong format is entered, the following error screen will be displayed for a few seconds upon confirmation:



To quit the Setup Menu, press key  for more than 2 sec; in case you wish to display and/or edit other parameters, scroll them up or down by shortly pressing keys  or , respectively.

GO TO [Chap. 7.1 - Connection settings](#)

GO TO [Chap. 7.2 - Equipment settings](#)

GO TO [Chap. 7.3 - Power factor correction settings](#)

GO TO [Chap. 7.4 - Communication interface settings](#)

GO TO [Chap. 7.5 - Alarm settings](#)

GO TO [Chap. 7.6 - Advanced settings](#)

GO TO [Chap. 7.7 - Parameter default range and values](#)

GO TO [Chap. 7.8 - Numerical value entering modes](#)

GO BACK TO [CONTENTS](#)

7.1 Connection settings

7.1.1 CT primary winding

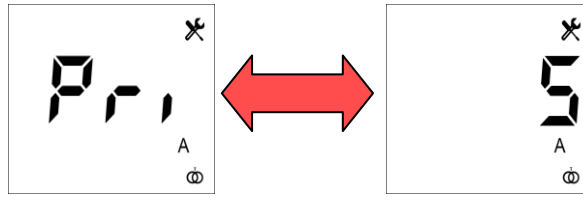

The default value is "5". The permitted range for the parameter is [5÷10000].

Example1: if the CT transformer size is 200/5, enter the "200" value.

Example 2: if the CT primary winding used is equal to 1500A, set:



If a permitted value is entered, the controller will move to the next parameter setting screen (**CT secondary winding**).

7.1.2 CT secondary winding

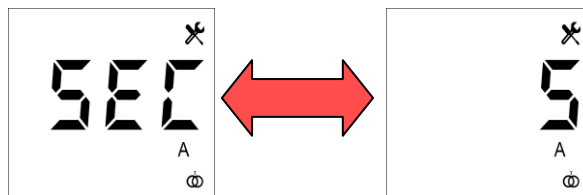

The default value is "5". The permitted range for the parameter is [1÷5].

If a permitted value is entered, the controller will move to the next parameter setting screen (**Current reading phase**).

7.1.3 Current reading phase

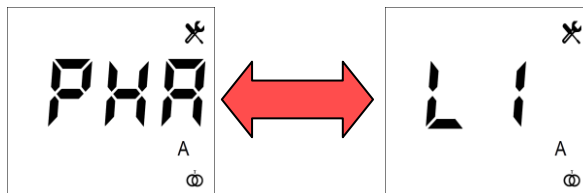

The default value is "L1". The possible permitted values for the parameter are [L1; L2; L3].

If the CT was connected to the R phase select L1; if the CT was connected to the S phase select L2; if the CT was connected to the T phase select L3.

After parameter is confirmed, the controller will move to the next parameter setting screen (**Reversal towards CT**).

7.1.4 Reversal towards CT

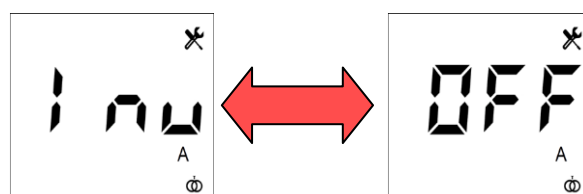

The default value is "OFF". The possible permitted values for the parameter are [ON; OFF].



If the cogeneration mode is enabled (**Cogeneration** = ON), by setting this parameter to "ON" the CT direction can be reversed via software without acting on the connections.

After parameter is confirmed, the controller will move to the next parameter setting screen (**Cogeneration**).

7.1.5 Cogeneration

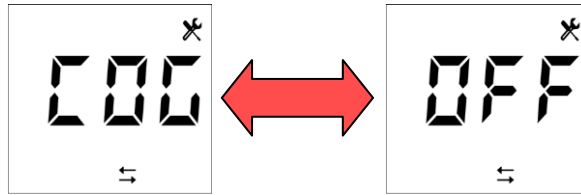

The default value is "OFF". The possible permitted values for the parameter are [ON; OFF].

Set parameter to "ON" when the CT is mounted on a line on which the current is generated by cogeneration systems and is absorbed by the load. If this parameter is set to "OFF" the CT direction will be automatically corrected via software to achieve always positive active power values.

After parameter is confirmed, the controller will move to the next parameter setting screen (**Frequency**).

7.1.6 Frequency

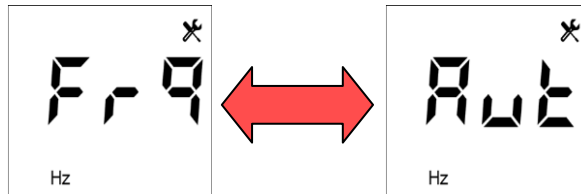

The default value is "Aut". The possible permitted values for the parameter are [50; 60; Aut].

Set the "Aut" value to enable the automatic selection between 50 and 60Hz upon controller first powering-up. In case of an excessive voltage harmonic distortion (measurement THDV%), we recommend setting the value at 50 Hz or 60 Hz, based on system nominal frequency.

After parameter is confirmed, the controller will move to the next parameter setting screen (**VT primary winding**).

7.1.7 VT primary winding

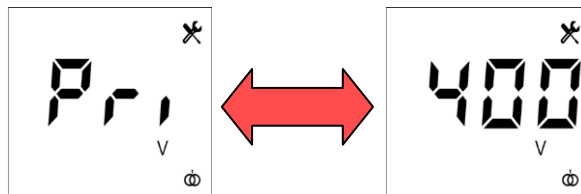

The default value is "400". The permitted range for the parameter is [210÷160000].

Example 1: if the transformer size is 690/400, enter the "690" value. NOTE: if the VT is not present, set the supply voltage value used for the Power Factor Controller (400 or 230).

Example 2: if the used VT Primary winding is equal to 100000A, set:



If a permitted value is entered, the controller will move to the next parameter setting screen (**VT secondary winding**).

7.1.8 VT secondary winding

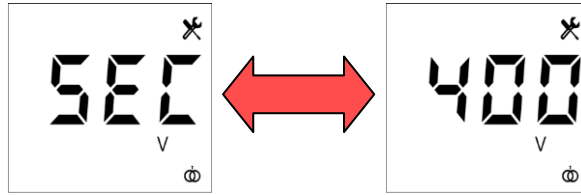

The default value is "400". The permitted ranges for the parameter are [210÷250] and [370÷430].

Example: if the transformer size is 690/400, enter the "400" value.

NOTE: if the VT is not present, set the supply voltage value used for the Power Factor Controller (400 or 230).

If a permitted value is entered, the controller will move to the next parameter setting screen (**Voltage reading phase**).

7.1.9 Voltage reading phase

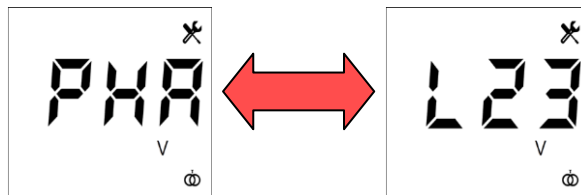

The default value is "L23". The possible permitted values for the parameter are [L1n; L2n; L3n; L12; L23; L31].

Example 1: if the power supply (or the VT) was connected between the phases S and T, select the value "L23".

Example 2: If the power supply (or VT) was connected between the R phase and the neutral, select the value "L1n".

After parameter is confirmed, the controller will move to the next parameter setting screen (**Capacitor nominal voltage**).

GO BACK TO **SETTINGS**

GO BACK TO **CONTENTS**

7.2 Equipment settings

7.2.1 Capacitor nominal voltage

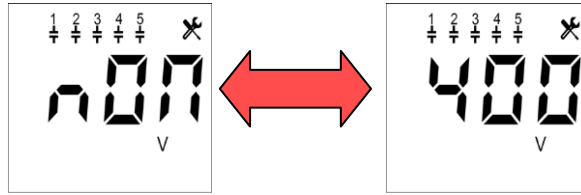

The default value is "400". The permitted range for the parameter is [50÷5000].

Example 1: if the capacitor nominal voltage is 525V, set the "525" value.

Example 2: if the voltage is 4000V, set (for the numerical value entering modes, refer to [Chap. 7.8 - Numerical value entering modes](#)):

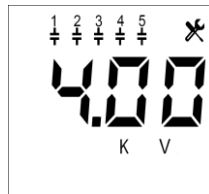

If the controller is installed on a Ducati energia power factor correction equipment, the value to be entered is the one specified on equipment plate.

WARNING: If blocking reactors (or equivalent devices) are present, it is recommended to set the same value of network nominal voltage (i.e. 400V); in these cases, also bank reactive power value must be set to the network voltage equivalent value (and not to the nominal value). For further details on settings in case of blocking reactors, refer to [Chap. 8.9 - Presence of blocking reactors](#).

If a permitted value is entered, the controller will move to the next parameter setting screen ([Manual power factor correction mode](#)).

7.2.2 Manual power factor correction mode

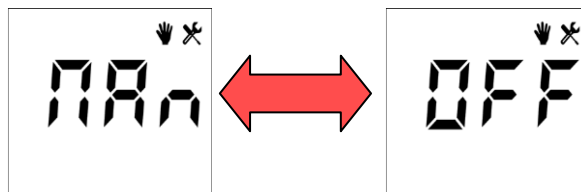

The default value is "OFF". The possible permitted values for the parameter are [ON; OFF].

To manually set capacitor insertion status, set this parameter to "ON".

NOTE: as an alternative, the [Manual power factor correction mode](#) can be enabled (or disabled) from any measurement displaying page by keeping key  pressed for 2sec.

If the parameter is edited from "ON" to "OFF", the automatic power factor correction algorithm will define the bank status, based on the associated [Step function](#) parameter, for further details refer to [Chap. 7.2.5](#).

If the parameter is edited from "OFF" to "ON", the user will have to set the output status by confirming or editing it in the pages displayed after. Sequence detailed description is specified in [Chap. 8.8 - Manual power factor correction mode](#).

Once finished, the cosphi measurement will be displayed with the manual mode active icon (hand):



7.2.3 Re-connection time

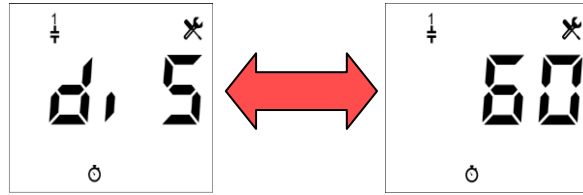

The default value is "60". The permitted range for the parameter is [1÷600]sec.

Example: if the discharge time of the capacitor banks is 60sec, set the value "60".

WARNING: the **Re-connection time** parameter must be set consistently with the indications given in the power factor correction equipment manual. Entering a time shorter than the recommended one can lead to equipment and/or controller damage.

If a permitted value is entered, the controller will move to the next parameter setting screen (**Switching manoeuvre time**).

7.2.4 Switching manoeuvre time

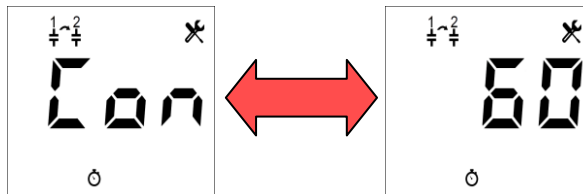

The default value is "60". The permitted range for the parameter is [1÷30000]sec.

Set a lower value if the reactive power to be corrected quickly varies. Set a higher value if the reactive power to be corrected slowly varies.

Example: to set a switching manoeuvre time of 9000sec, enter:

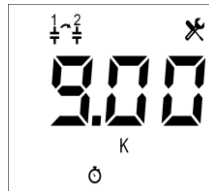

If a permitted value is entered, the controller will move to the next parameter setting screen (**Step 1 function**).

7.2.5 Step n function (n=1,2,3,4,5)

By scrolling the **Setup Menu** for each relay output (1 to 5) there are a first page for function definition (**Step n function**) and a second page for further parameter specification (**Step n power** or **Alarm n**) based on the selected function.

NOTE: the images and the description below show the **Step 1 function** parameter, i.e. all what can be applied for all steps with n index with n = 1,2,3,4,5.

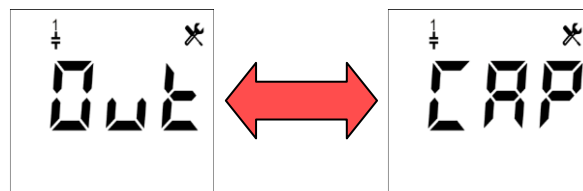

The default value is "CAP". The possible permitted values for the parameter are [CAP; OFF; ON; ALA].

Select the "CAP" value for an output connected to a capacitor bank that you want to be automatically piloted by the controller.



Select the "OFF" value for an output not connected or connected to a bank that you do not want to use.

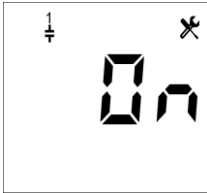

Select the "ON" value for an output connected to a bank that you want to keep always on.

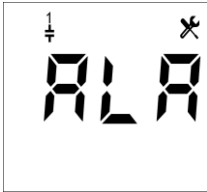

Select the "ALA" value for an output used as alarm contact.

The controller will move to different screens based on the selection made:

- if "CAP", "OFF" or "ON" value has been set, the controller will move to the setting screen of parameter **Step n power** [Chap.7.2.6](#);
- if the "ALA" value has been set, the controller will move to the setting screen of parameter **Alarm n** [Chap. 7.2.7](#).

By confirming the **Step n power** or **Alarm n** parameter or by scrolling the Setup Menu with key  the parameter **Step n+1 function** will be displayed, and so on until index n = 5.

7.2.6 Step n power (n=1,2,3,4,5)

By scrolling the Setup Menu for each relay output (1 to 5) there are a first page for function definition (**Step n function**) and a second page for further parameter specification (**Step n power** or **Alarm n**) based on the selected function.

NOTE: the parameter **Step n power** is displayed only for the relay outputs for which the parameter **Step n function** has been set to "CAP", "OFF" or "ON". For further details, refer to [Chap. 7.2.5](#).

NOTE: the images and the description below show the **Step 1 power** parameter, i.e. all what can be applied for all steps with n index with n = 1,2,3,4,5.

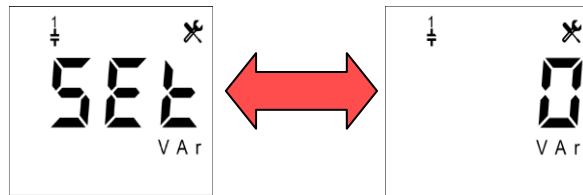

The default value is "0". The permitted range for the parameter is [0÷999]kVar.

Example: to set 1kVar, enter (for numerical value entering mode refer to [Chap. 7.8 - Numerical value entering modes](#)):



If the controller is installed on a Ducati energia power factor correction equipment, the value to be entered is the one specified on equipment plate.

If a permitted value is entered, the controller will move to the setting screen of parameter **Step n+1 function** (refer to [Chap. 7.2.5 - Step n function \(n=1,2,3,4,5\)](#)).



7.2.7 Alarm n (n=1,2,3,4,5)

By scrolling the Setup Menu for each relay output (1 to 5) there are a first page for function definition (**Step n function**) and a second page for further parameter specification (**Step n power** or **Alarm n**) based on the selected function.

NOTE: the parameter **Alarm n** is displayed only for the relay outputs for which the parameter **Step n function** has been set to "ALA". Refer to **Chap. 7.2.5** for further details on parameter **Step n function**.

NOTE: the images and the description below show the **Alarm 1** parameter, i.e. all what can be applied for all steps with n index with n = 1,2,3,4,5.

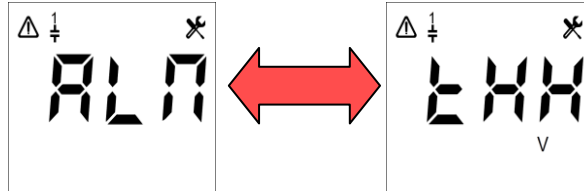

The default value is "THHV". The possible permitted values for the parameter are [THHV; THHA; THLV; THLA; THD%A; THD%V; TMP°C; Hlcosphi; LOcosphi; ALL].

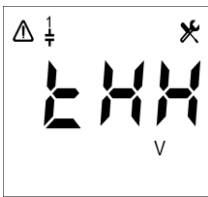

Select the "THHV" value to associate the relay output n to the overvoltage alarm (for further details refer to **Chap. 7.5.1 - Overvoltage alarm threshold** and **Chap. 7.5.2 - Overvoltage alarm delay**).

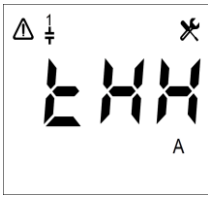

Select the "THHA" value to associate the relay output n to the overcurrent alarm (for further details refer to **Chap. 7.5.3 - Overcurrent alarm threshold** and **Chap. 7.5.4 - Overcurrent alarm delay**).



Select the "THLV" value to associate the relay output n to the low voltage alarm (for further details refer to **Chap. 7.5.5 - Low voltage alarm threshold** and **Chap. 7.5.6 - Low voltage alarm delay**).



Select the "THLA" value to associate the relay output n to the low current alarm (for further details refer to **Chap. 7.5.7 - Low voltage current threshold** and **Chap. 7.5.8 - Low current alarm delay**).

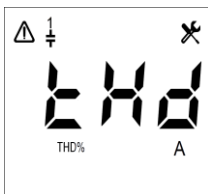

Select the "THD%A" value to associate the relay output n to the high THDI% alarm (for further details refer to **Chap. 7.5.11 - THDI alarm threshold** and **Chap. 7.5.12 - THDI alarm delay**).

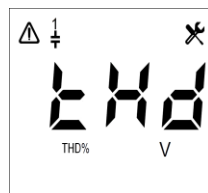

Select the "THD%V" value to associate the relay output n to the high THDV% alarm (for further details refer to **Chap. 7.5.9 - THDV alarm threshold** and **Chap.7.5.10 - THDV alarm delay**).

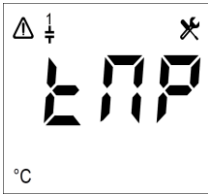

Select the “TEMP°C” value to associate the relay output n to the high temperature alarm (for further details refer to [Chap. 7.5.13 - Temperature alarm threshold](#) and [Chap. 7.5.14 - Temperature alarm delay](#)).

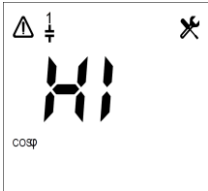

Select the “HIcosphi” value to associate the relay output n to the power factor overcorrection alarm (for further details, refer to [Chap. 7.3.1 - Cosphi setpoint](#) and [Chap. 7.3.2 - Cosphi setpoint tolerance](#)).



Select the “LOcosphi” value to associate the relay output n to the power factor correction failed alarm (for further details, refer to [Chap. 7.3.1 - Cosphi setpoint](#) and [Chap. 7.3.2 - Cosphi setpoint tolerance](#)).



Select the “ALL” value to associate the relay output to the presence of at least one of the previous alarms:

After parameter is confirmed, the controller will move to the next parameter setting screen **Step n+1 function** (refer to [Chap. 7.2.5 - Step n function \(n=1,2,3,4,5\)](#)).

GO BACK TO [SETTINGS](#)

GO BACK TO [CONTENTS](#)

7.3 Power factor correction settings

7.3.1 Cosphi setpoint

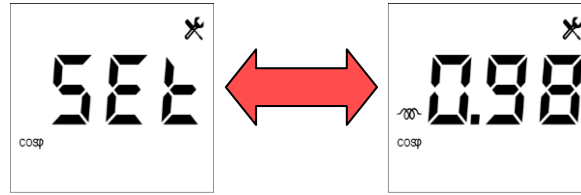

The default value is "0.98", inductive. The permitted range for the numerical value is [0.50÷1]. In addition, both an inductive or capacitive load can be set.

NOTE: This parameter, together with the **Cosphi setpoint tolerance** define together the value range within which the controller will consider system as corrected and, consequently, also the activation thresholds for the power factor correction failed and power factor overcorrection alarms. For further details, refer to [Chap. 7.3.2](#).

If a permitted value is entered, the controller will move to the next parameter setting screen (**Cosphi setpoint tolerance**).

7.3.2 Cosphi setpoint tolerance

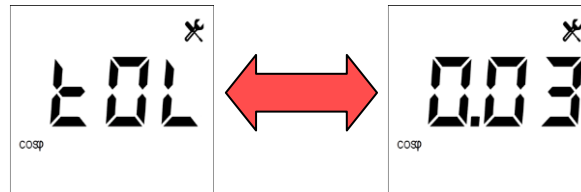

The default value is "0.03". The permitted range for the parameter is [0.01÷0.1].

Together with the **Cosphi setpoint**, this parameter defines the range of values within which the controller will consider system corrected. For example, with cosphi setpoint = 0.97 inductive and cosphi setpoint tolerance = 0.02, the controller will try to reach a cosphi value between 0.95 inductive and 0.99 inductive. In these conditions: with a cosphi value < 0.95 the controller will connect a capacitor bank (or will display under-compensation error after the time set by parameter **P.23 – Power factor correction failed alarm delay** ([Chap. 7.6](#)) in which the value remains continuously out of tolerance) with a cosphi value of 1.00 or with a capacitive cosphi value, the controller will disconnect a capacitor bank (or will display over-compensation error after the time set by parameter **P.22 – Power factor overcorrection alarm delay** ([Chap. 7.6](#)) in which the value remains continuously out of tolerance).

If a permitted value is entered, the controller will move to the next parameter setting screen (**Re-connection time**).

7.3.3 Average measurement time

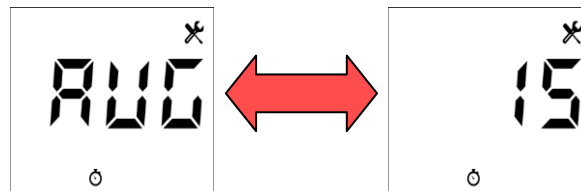

The default value is "15". The permitted range for the parameter is [1÷60] minutes.

Example: if it is necessary to obtain the average value of powers every 5 minutes set the value 5.

NOTE: average values are only available via the communication interfaces RS485 and Radio 868MHz for the provided models.

If a permitted value is entered, the controller will move to the next parameter setting screen (**Protocol**).

GO BACK TO [SETTINGS](#)

GO BACK TO [CONTENTS](#)

7.4 Communication interface settings

NOTE: The parameters **Protocol**, **Address** and **Baudrate** define only the RS485 communication for the provided models. For models without RS485, the pages of the Setup Menu are anyway available, but have no effect.

7.4.1 Protocol

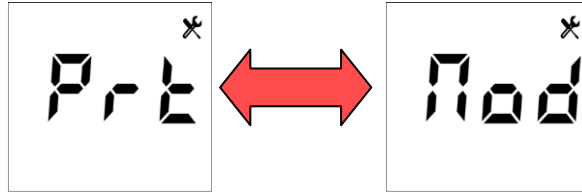

The default value is "Mod". The possible permitted values for the parameter are [Mod; duC]. Select "Mod" to set the Modbus-RTU protocol. Select "duC" to set the ASCII Ducbus protocol.

NOTE: if the **Address** parameter is set to a value greater than 98 and **Protocol** is changed from Mod to duC, the default value (31) will be automatically restored.

For detailed information on Modbus-RTU and ASCII Ducbus protocol specifications, refer to the documents available at the following link: ftp://ftp.ducatienergia.com/DucatiSistemi/Protocols_Analysers/

After parameter is confirmed, the controller will move to the next parameter setting screen (**Address**).

7.4.2 Address

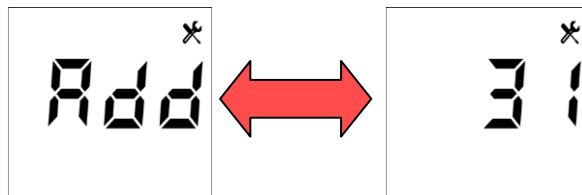

The default value is "31" (or the previously-set value). If the **Protocol** parameter is set to Mod (Modbus RTU) the permitted range is [1÷247], while if it is set to duC (ASCII Ducbus), the permitted range is [1÷98].

NOTE: if the parameter is set to a value greater than 98 and **Protocol** is changed from Mod to duC, the default value (31) will be automatically restored.

If a permitted value is entered, the controller will move to the next parameter setting screen (**Baudrate**).

7.4.3 Baudrate

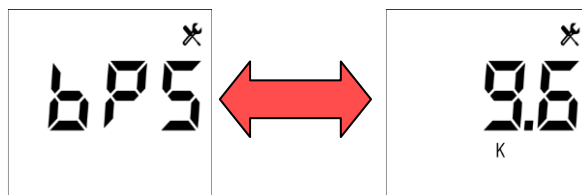

The default value is "9.6k". The possible permitted values for the parameter are [9.6k;19.2k;38.4k;57.6k;115k]bps.

NOTE 1: the values to be associated to the parameter are always expressed in bps.

NOTE 2: the value "115k" corresponds to a baudrate of 115.2kbps.

After parameter is confirmed, the controller will move to the next parameter setting screen (**Overvoltage alarm threshold**).

GO BACK TO **SETTINGS**

GO BACK TO **CONTENTS**

7.5 Alarm settings

7.5.1 Overvoltage alarm threshold

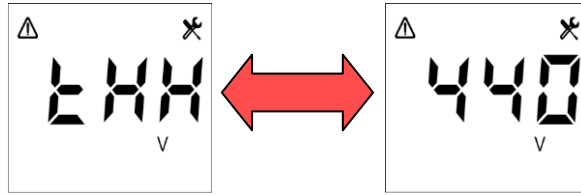

The default value is "440". The possible permitted values for the parameter will range from 90% to 110% of the value set for parameter **VT primary winding** with a 1% resolution. To disable the alarm select the "OFF" value.

Example 1: if **VT primary winding** = "400", the possible settable values are [440; 436; 432; 428; 424; 420; 416; 412; 408; 404; 400; 396; 392; 388; 384; 380; 376; 372; 368; 364; 360; OFF].

Example 2: if **VT primary winding** = "5.00k" and you wish to set the threshold at 105% (5,25kV), scroll the suggested values and set:



Example 3: to disable the alarm set:



After parameter is confirmed, the controller will move to the next parameter setting screen (**Overvoltage alarm delay**).

7.5.2 Overvoltage alarm delay

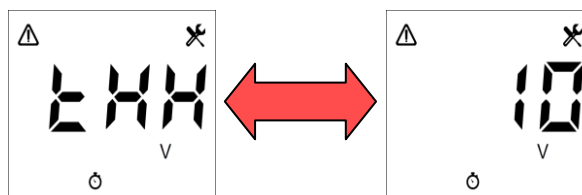

The default value is "10". The permitted range for the parameter is [1÷255] seconds.

NOTE: the alarm will be activated and deactivated if the reference measurement steadily stays above or under the threshold for the time set.

If a permitted value is entered, the controller will move to the next parameter setting screen (**Overcurrent alarm threshold**).

7.5.3 Overcurrent alarm threshold

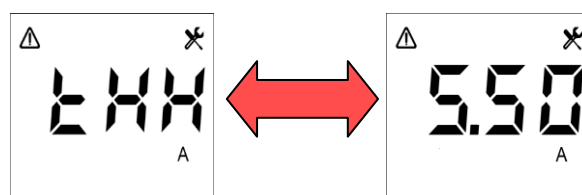

The default value is "5.50". The possible permitted values for the parameter will range from 90% to 120% of the value set for parameter **CT primary winding** with a 1% resolution. To disable the alarm select the "OFF" value.



Example 1: if **CT primary winding** = "5", the possible settable values are [6.00; 5.95; 5.90; 5.85; 5.80; 5.75; 5.70; 5.65; 5.60; 5.55; 5.50; 5.45; 5.40; 5.35; 5.30; 5.25; 5.20; 5.15; 5.10; 5.05; 5.00; 4.95; 4.90; 4.85; 4.80; 4.75; 4.70; 4.65; 4.60; 4.55; 4.50; OFF).

Example 2: if **CT primary winding** = "5.00k" and you wish to set the threshold at 105% (5.25kA), scroll the suggested values and set:



Example 3: to disable the alarm set:



After parameter is confirmed, the controller will move to the next parameter setting screen (**Overcurrent alarm delay**).

7.5.4 Overcurrent alarm delay

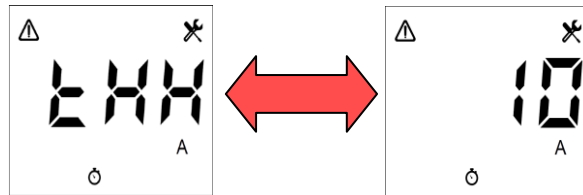

The default value is "10". The permitted range for the parameter is [1÷255] seconds.

NOTE: the alarm will be activated and deactivated if the reference measurement steadily stays above or under the threshold for the time set.

If a permitted value is entered, the controller will move to the next parameter setting screen (**Low voltage alarm threshold**).

7.5.5 Low voltage alarm threshold

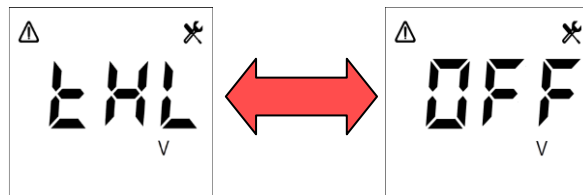

The default value is "OFF". The possible permitted values for the parameter will range from 90% to 110% of the value set for parameter **VT primary winding** with a 1% resolution. To disable the alarm select the "OFF" value.

Example 1: if **VT primary winding** = "400", the possible settable values are [440; 436; 432; 428; 424; 420; 416; 412; 408; 404; 400; 396; 392; 388; 384; 380; 376; 372; 368; 364; 360; OFF].

Example 2: if **VT primary winding** = "5.00k" and you wish to set the threshold at 95% (4.75kV), scroll the suggested values and set:





After parameter is confirmed, the controller will move to the next parameter setting screen (**Low voltage alarm delay**).

7.5.6 Low voltage alarm delay

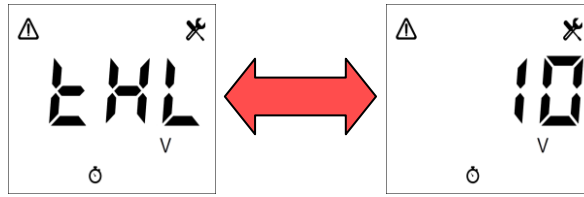

The default value is "10". The permitted range for the parameter is [1÷255] seconds.

NOTE: the alarm will be activated and deactivated if the reference measurement steadily stays above or under the threshold for the time set.

If a permitted value is entered, the controller will move to the next parameter setting screen (**Low current alarm threshold**).

7.5.7 Low current alarm threshold

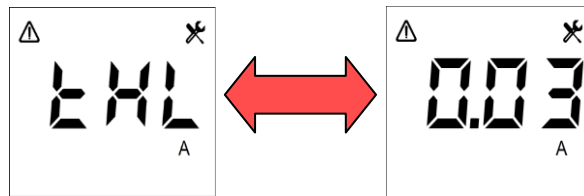

The default value is "0.03". The possible permitted values for the parameter will range from 0.7% to 10% of the value set for parameter **CT primary winding** with a 0.5% resolution.

Example 1: if **CT primary winding** = "5", the possible settable values are [0.03; 0.05; 0.08; 0.10; 0.13; 0.15; 0.18; 0.20; 0.23; 0.25; 0.28; 0.30; 0.33; 0.35; 0.38; 0.40; 0.43; 0.45; 0.48; 0.50].

Example 2: if **CT primary winding** = "5.00k" and you wish to set the threshold at 5% (250A), scroll the suggested values and set:



After parameter is confirmed, the controller will move to the next parameter setting screen (**Low current alarm delay**).

7.5.8 Low current alarm delay

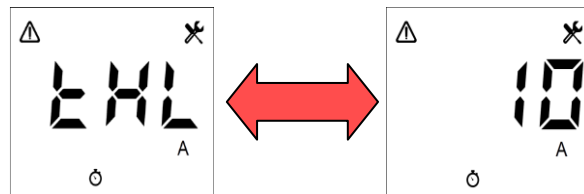

The default value is "10". The permitted range for the parameter is [1÷255] seconds.

NOTE: the alarm will be activated and deactivated if the reference measurement steadily stays above or under the threshold for the time set.

If a permitted value is entered, the controller will move to the next parameter setting screen (**THDV alarm threshold**).

7.5.9 THDV alarm threshold

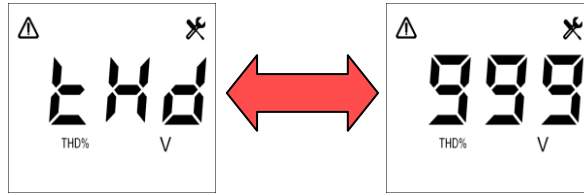

The default value is "999". The permitted range for the parameter is [1%÷100%]. To disable the alarm enter value "999"

Example: to set the threshold at 10%, enter:

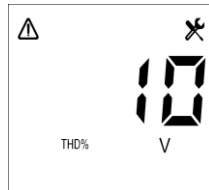

If a permitted value is entered, the controller will move to the next parameter setting screen (**THDV alarm delay**).

7.5.10 THDV alarm delay

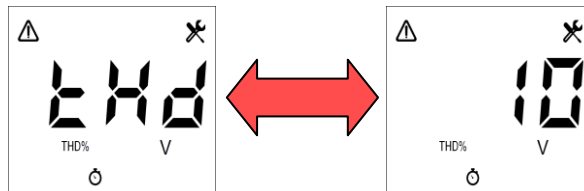

The default value is "10". The permitted range for the parameter is [1÷255] seconds.

NOTE: the alarm will be activated and deactivated if the reference measurement steadily stays above or under the threshold for the time set.

If a permitted value is entered, the controller will move to the next parameter setting screen (**THDI alarm threshold**).

7.5.11 THDI alarm threshold

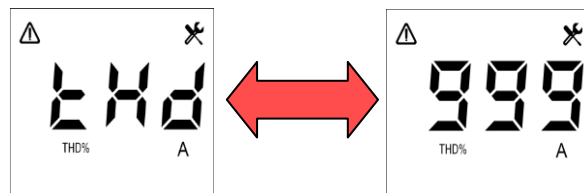

The default value is "999". The permitted range for the parameter is [1%÷100%]. To disable the alarm enter value "999"

Example 1: to set the threshold at 10%, enter:

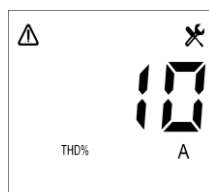

If a permitted value is entered, the controller will move to the next parameter setting screen (**THDI alarm delay**).

7.5.12 THDI alarm delay

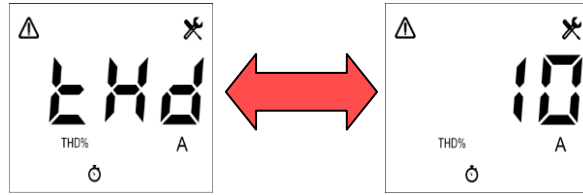

The default value is "10". The permitted range for the parameter is [1÷255] seconds.

NOTE: the alarm will be activated and deactivated if the reference measurement steadily stays above or under the threshold for the time set.

If a permitted value is entered, the controller will move to the next parameter setting screen (**Temperature alarm threshold**).

7.5.13 Temperature alarm threshold

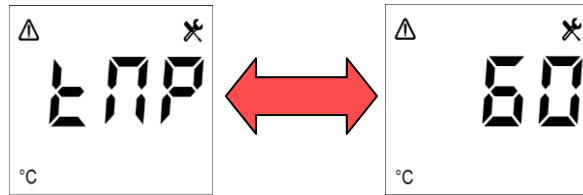

The default value is "60". The permitted range for the parameter is [0÷80]°C.

To disable the alarm enter value "999"

If a permitted value is entered, the controller will move to the next parameter setting screen (**Temperature alarm delay**).

7.5.14 Temperature alarm delay

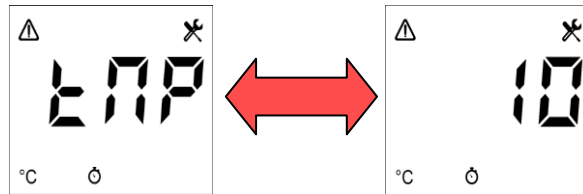

The default value is "10". The permitted range for the parameter is [1÷255] seconds.

NOTE: the alarm will be activated and deactivated if the reference measurement steadily stays above or under the threshold for the time set.

If a permitted value is entered, the controller will move to the next parameter setting screen (**Reset**).

GO BACK TO **SETTINGS**

GO BACK TO **CONTENTS**



7.6 Advanced settings

WARNING: if not expressly requested by this manual, the following parameters must be edited only by qualified staff and/or according to the indications provided by Ducati Energia technicians.

To access the Advanced Parameter Menu press keys  and  at the same time for at least 10sec.

The parameters will be suggested with an identification number from P.1 to P.25. For the essential features of these parameters, refer to the table in [Chap.7.7](#). For further details, refer to the complete operating manual available at the following address: <https://www.ducatienergia.com/product.php?lang=en&id=8&cat=13&product=89>

GO BACK TO [SETTINGS](#)

GO BACK TO [CONTENTS](#)

7.7 Parameter default range and values

Parameter	UM	Min. value	Max. value	Default	Id.	Details
CT primary winding	A	5	10000	5	Pri	Chap. 7.1.1
CT secondary winding	A	1	5	5	SEC	Chap. 7.1.2
Current reading phase	-	L1/L2/L3		L1	PHA	Chap. 7.1.3
Reversal towards CT	-	ON/OFF		OFF	Inu	Chap. 7.1.4
Cogeneration	-	ON/OFF		OFF	COG	Chap. 7.1.5
Frequency	Hz	50/60/Aut		Aut	Frq	Chap. 7.1.6
VT primary winding	V	210	160000	400	Pri	Chap. 7.1.7
VT secondary winding	V	210÷250 or 370÷430		400	SEC	Chap. 7.1.8
Voltage reading phase	-	L1n/L2n/L3n/L12/L23/L31		L23	PHA	Chap. 7.1.9
Capacitor nominal voltage	V	50	5000	400	nOM	Chap. 7.2.1
Manual power factor correction mode	-	ON/OFF		OFF	MAn	Chap. 7.2.2
Re-connection time	s	1	600	60	diS	Chap. 7.2.3
Switching manoeuvre time	s	1	30000	60	Con	Chap. 7.2.4
Step n function (n=1, 2, 3, 4, 5)	-	CAP/ON/OFF/ALA		CAP	Out	Chap. 7.2.5
Step n power (n=1, 2, 3, 4, 5)	kVAr	0	999	0	SEt	Chap. 7.2.6
Alarm n (n=1, 2, 3, 4, 5)	-	THHV/THHA/THLV/THLA/THD%/V/THD%/A/TMP°C/HIcosphi/LOcosphi/ALL		THHV	ALM	Chap. 7.2.7
Cosphi setpoint	-	0.50 CAP	0.50 IND	0.98 IND	SEt	Chap. 7.3.1
Cosphi setpoint tolerance	-	0.01	0.1	0.03	tOL	Chap. 7.3.2
Average measurement time	min	1	60	15	AVG	Chap. 7.3.3
Protocol	-	Mod/duC		Mod	Prt	Chap. 7.4.1
Address	-	1 (Mod) 1 (duC)	247 (Mod) 98 (duC)	31	Add	Chap. 7.4.2
Baudrate	bps	9.6k/19.2k/38.4k/57.6k/115.2k		9.6k	bPS	Chap. 7.4.3
Overvoltage alarm threshold	V	90% VT primary winding	110% VT primary winding	110% VT primary	tHH	Chap. 7.5.1



				winding		
Overvoltage alarm delay	s	1	255	10	tHH	Chap. 7.5.2
Overcurrent alarm threshold	A	90% CT primary winding	120% CT primary winding	120% CT primary winding	tHH	Chap. 7.5.3
Overcurrent alarm delay	s	1	255	10	tHH	Chap. 7.5.4
Low voltage alarm threshold	V	90% VT primary winding	110% VT primary winding	OFF	tHL	Chap. 7.5.5
Low voltage alarm delay	s	1	255	10	tHL	Chap. 7.5.6
Low current alarm threshold	A	0.7% CT primary winding	10% CT primary winding	0.7% CT primary winding	tHL	Chap. 7.5.7
Low current alarm delay	s	1	255	10	tHL	Chap. 7.5.8
THDV alarm threshold	%	1	100	999 (OFF)	tHd	Chap. 7.5.9
THDV alarm delay	s	1	255	10	tHd	Chap. 7.5.10
THDI alarm threshold	%	1	100	999 (OFF)	tHd	Chap. 7.5.11
THDI alarm delay	s	1	255	10	tHd	Chap. 7.5.12
Temperature alarm threshold	°C	0	80	60	tMP	Chap. 7.5.13
Temperature alarm delay	s	1	255	10	tMP	Chap. 7.5.14
P.1 – Manoeuvre time differentiation	-	ON / OFF		OFF	P.1	Chap. 7.6
P.2 – Disconnection manoeuvre time	s	1	30000	60	P.2	Chap. 7.6
P.3 – Evaluation time	network cycles	10	1500	275	P.3	Chap. 7.6
P.4 – Transient time during disconnection	network cycles	5	250	10	P.4	Chap. 7.6
P.5 – Transient time during insertion	network cycles	5	250	10	P.5	Chap. 7.6
P.6 – Measurement stability check	-	ON/OFF		OFF	P.6	Chap. 7.6
P.7 – Stability check threshold	%	1	50	20	P.7	Chap. 7.6
P.8 – Presence of blocking reactors	-	ON/OFF		OFF	P.8	Chap. 7.6
P.9 – Degradation threshold 1	%	5/10/15/20/25/30/35/40/45/50/55/60/65/70/75/80/85/90/95/100		40	P.9	Chap. 7.6
P.10 – Fault threshold 1	%	5/10/15/20/25/30/35/40/45/50/55/60/65/70/75/80/85/90/95/100		80	P.10	Chap. 7.6
P.11 – Degradation threshold 2	%	5/10/15/20/25/30/35/40/45/50/55/60/65/70/75/80/85/90/95/100		30	P.11	Chap. 7.6
P.12 – Fault threshold 2	%	5/10/15/20/25/30/35/40/45/50/55/60/65/70/75/80/85/90/95/100		70	P.12	Chap. 7.6
P.13 – Current alarm reset	-	ON/OFF		ON	P.13	Chap. 7.6
P.14 – Displaying of values from harmonic analysis	-	ON/OFF		OFF	P.14	Chap. 7.6
P.15 – Power threshold for auto-acquisition	VA (on CT and VT secondary windings)	0	200	20	P.15	Chap. 7.6
P.16 –868MHz radio address	-	0	247	31	P.16	Chap. 7.6
P.17 –868MHz radio channel	-	0	5	0	P.17	Chap. 7.6
P.18 –868MHz radio power	-	0	17	11	P.18	Chap. 7.6
P.19 – Type of network	-	3PH/1PH		3PH	P.19	Chap. 7.6



P.20 – Micro-interruption duration	msec	5	40	5	P.20	Chap. 7.6
P.21 – Step maximum connection time	hours	0	999	8	P.21	Chap. 7.6
P.22 – Power factor overcorrection alarm delay	min	0	255	60	P.22	Chap. 7.6
P.23 – Power factor correction failed alarm delay	min	0	255	60	P.23	Chap. 7.6
P.24 – THDI invalidation threshold	A (on CT secondary winding)	0.03	5	0.2	P.24	Chap. 7.6
P.25 – Alarm masking management	-	0/1/2/3		0	P.25	Chap. 7.6

GO BACK TO [SETTINGS](#)

GO BACK TO [CONTENTS](#)



7.8 Numerical value entering modes



The following ranges are available if a numerical value has to be entered:

1. 0÷999;
2. 1000÷9999;
3. 10000÷99999;
4. 100000÷999999.

NOTE: To enter a value higher than 999 starting from a previously set value in one of ranges 2, 3 or 4 that does not include it, at first remove the thousands icon (**k**). To this end, use key  to decrease the digit immediately to the left of the dot until the icon disappears.

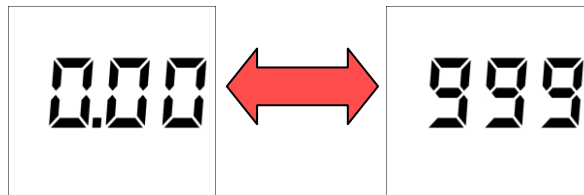
In the first case, simply use the single digits.



In the second case, use key  to move to the position of the first digit from the left (red arrow) and increase it by using key  until the thousands icon (**k**) and the dot on digit right side appear, then adjust the digits by taking into account that the resolution will be in the tens.

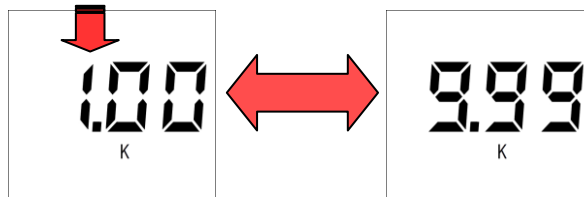

In the third case, move to the position of the second digit from the left (red arrow) and increase it by using key  until the thousands icon (**k**) and the dot on digit right side appear, then adjust the remaining digits by taking into account that the resolution will be in the hundreds.

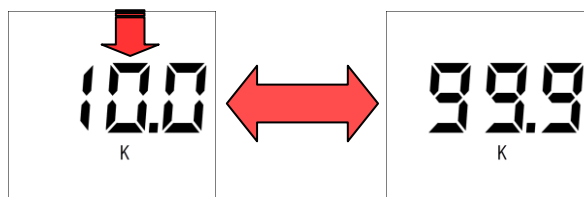

In the fourth case, move to the position of the third digit from the left (red arrow) and increase it by using key  until the thousands icon (**k**) appears, then adjust the remaining digits by taking into account that the resolution will be in the thousands.

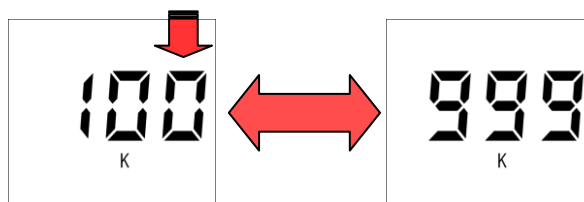

GO BACK TO **SETTINGS**

GO BACK TO **CONTENTS**



8 USING THE CONTROLLER

- GO TO [Chap. 8.1 - Controller information](#)
- GO TO [Chap. 8.2 - Display and key description](#)
- GO TO [Chap. 8.3 - Measurement menu](#)
- GO TO [Chap. 8.4 - Statistics menu](#)
- GO TO [Chap. 8.5 - Alarm management and display](#)
- GO TO [Chap. 8.6 - Reset menu](#)
- GO TO [Chap. 8.7 - Communication interfaces](#)
- GO TO [Chap. 8.8 - Manual power factor correction mode](#)
- GO TO [Chap. 8.9 - Presence of blocking reactors](#)
- GO TO [Chap. 8.10 - Firmware update](#)
- GO BACK TO [CONTENTS](#)

8.1 Controller information

8.1.1 Model and Serial Number

The information relating to model (with relevant Part Number) and Serial Number of the R5 Controller can be inferred from the silver plate affixed on enclosure right side.

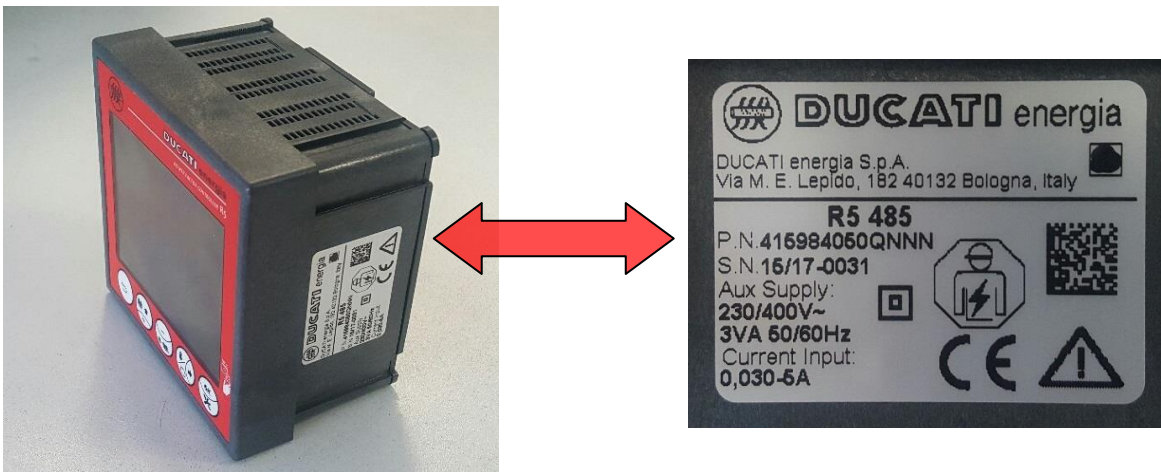

The same information can be also inferred from the RS485, Radio 868MHz communication interfaces and through the Ducati Smart Energy App. For further information, refer to [Chap. 8.7 - Communication interfaces](#).

8.1.2 Firmware Version

For further details, refer to the complete manual available on:

<https://www.ducatienergia.com/product.php?lang=en&id=8&cat=13&product=89>

GO BACK TO [USING THE CONTROLLER](#)

GO BACK TO [CONTENTS](#)



8.2 Display and key description

8.2.1 Display

The display includes both icons and alphanumerical fields.

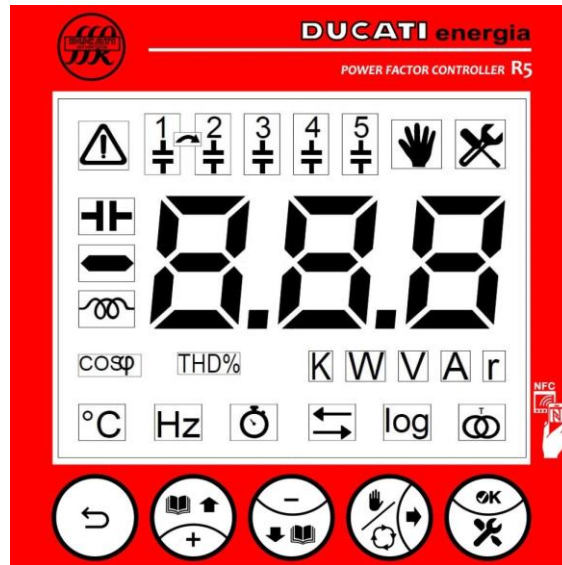

The following table lists them with the relevant meanings:

Alarm Presence or Alarm Parameter.	
Capacitor Status or Capacitor Parameter.	
Manual Mode active.	
Configuration setting pages.	
Measurement/parameter sign.	
Measurement/parameter value or label.	
Network frequency measurement or parameter.	
Controller temperature measurement or parameter.	
Setting parameters of instrument/bank/system times or waiting for the reconnection and/or manoeuvre with the available bank time to elapse.	
Cogeneration mode (4-Quadrants) active or Cogeneration parameter.	
(If flashing) RS485/Radio 868MHz communication in progress.	
CT and VT Transformer parameters.	
Measurement unit.	
Cosphi measurement or parameter.	
THD% measurement or parameter.	



8.2.2 Key functions

The function associated to keys depends on the context in which they are pressed. The following tables describe key functions in the various menus available on R5 Controller.

KEY FUNCTIONS – MEASUREMENT MENU		
Key	Short press	Long press
	Previous measurement	Access to Statistics Menu
	Next measurement	(If pressed together) Access to Current Alarm Menu
	Previous measurement	
	Next measurement	Enable/Disable Manual Power Factor Correction Mode
	Next measurement	Access to Setting Menu

KEY FUNCTIONS – SETUP MENU		
Key	Short press	Long press
	Previous parameter	Exit from the Setup Menu
	Parameter / digit increment	-
	Parameter / digit decrement	-
	Next parameter / next digit	-
	Parameter confirmation and shift to next parameter	-

KEY FUNCTIONS – STATISTICS MENU		
Key	Short press	Long press
	Previous value	Exit from the Statistics Menu
	Next value	-
	Previous value	-
	Next value	-
	Next value	-

KEY FUNCTIONS – CURRENT ALARM MENU		
Key	Short press	Long press
	Previous alarm	Exit from the Current Alarm Menu
	Next alarm	-
	Previous alarm	-
	Next alarm	-
	Alarm reset / Next alarm (for details, refer to Chap. 8.5.1 - Current alarm menu)	-

GO BACK TO [USING THE CONTROLLER](#)





GO BACK TO [CONTENTS](#)



8.3 Measurement menu

After completing the auto-acquisition procedure (refer to [Chap. 6](#)), after every power-up and after 2 minutes of activity in any page (excluding those of the Current Alarm Menu), the controller will automatically move to the first page of the Measurement Menu. You can also go back to the Measurement Menu from any other menu by pressing key  for more than 2sec.

The Measurement Menu includes a page devoted to each one of the following measurements: **cosphi**, **reactive power**, **current**, **voltage**, **frequency**, **active power**, **apparent power**, **THDI%**, **THDV%**, **power factor** and **temperature**.

Now press one of keys ,  or  to scroll the pages or one of keys  or  to scroll pages back.

NOTE. the measurements of **reactive power**, **current**, **voltage**, **active power** and **apparent power** are set by default with RMS values; to display only the essential components (at 50 or 60Hz, based on network frequency) achieved through the harmonic analysis, set to "ON" the parameter **P.14 – Displaying of values from harmonic analysis** inside the Advanced Setting Menu in [Chap. 7.6](#).

The display fields relating to the Measurement Menu are: the numerical value (area highlighted in red) including three digits, the dot if necessary, the sign and the indication of the inductive or capacitive load, and the measuring unit and/or type of measurement (area highlighted in blue).

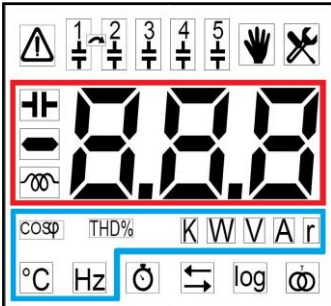

The icons of the other fields can be present and, as a whole provide controller general status. For the detailed description of the single icons, refer to [Chap. 8.2 - Display and key description](#).

NOTE: should the measurement to be displayed not be valid or out of range, the "--" value will be displayed.



The first displayed page is the one relating to the **cosphi** that will include the numerical value and the indication on the type of load (inductive or capacitive), as well as the wording "cosφ". Should measurement not be available (due to a current 0.7% lower than the **CT Secondary winding** parameter [Chap. 7.1.2](#)) the controller will show "--".



The next page relates to the **reactive power**, which is recognisable by the measurement unit in [VAr].



The next page relates to the **current**, which is recognisable by the measurement unit in [A].



The next page relates to the **voltage**, which is recognisable by the measurement unit in [V].



The next page relates to the **frequency**, which is recognisable by the measurement unit in [Hz].



The next page relates to the **active power**, which is recognisable by the measurement unit in [W].



The next page relates to the **apparent power**, which is recognisable by the measurement unit in [VA].

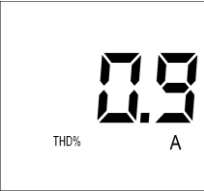

The next page relates to the **THDI%**, which is recognisable by the labels “THD%” and “A”. If the measured harmonic current is below the value defined by parameter **P.24 – THDI invalidation threshold** (for further details refer to **Chap. 7.6**) the display will show “---”.

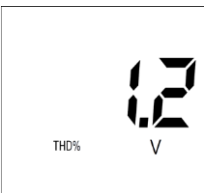

The next page relates to the **THDV%**, which is recognisable by the labels “THD%” and “V”.

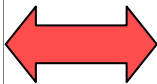

The next displayed page relates to the **power factor**, where “PF” will be alternately shown with the numerical value with the indication of the type of load (inductive or capacitive). Should measurement not be available (due to a current 0.7% lower than the **CT Secondary winding** parameter **Chap. 7.1.2**) the controller will show “---”.



The next page relates to the **temperature** inside controller, which is recognisable by the measurement unit in [°C].

NOTE: For the values of **reactive power**, **active power** and **apparent power**, if the measured value is \geq equal to one MVar, one MW and one MVA respectively, the following screen will be respectively displayed alternately with the numerical value.









GO BACK TO **USING THE CONTROLLER**

GO BACK TO **CONTENTS**

8.4 Statistics menu

The Statistics Menu includes the information relating to capacitor banks and to the alarms occurred during operation.

The Statistics Menu can be accessed from the Measurement Menu by pressing key  for more than 2sec.

Now press one of keys ,  or  to scroll the pages or one of keys  or  to scroll pages back.

The information relating to each capacitor bank relates to the number of insertions **InS**, the number of manoeuvres of the associated contactor **OP**, the number of operating hours **h** and the estimated reactive power **ESt**.

GO TO [Chap. 8.4.1 - Capacitor bank statistics](#).

In addition, there are also the contactors relating to the occurrences of the following alarms: **overvoltage**, **overcurrent**, **low voltage**, **low current**, **THDI**, **THDV**, **temperature**, **power factor overcorrection**, **power factor correction failed** and **micro-interruptions**. For detailed information on threshold and delay time settings of the single alarms, refer to [Chap. 7.3 - Power factor correction settings](#), [Chap. 7.5 - Alarm settings](#), [Chap. 7.6 - Advanced settings](#).

GO TO [Chap. 8.4.2 - Alarm statistics](#).

GO BACK TO [USING THE CONTROLLER](#)

GO BACK TO [CONTENTS](#)

8.4.1 Capacitor bank statistics

The first displayed page relates to the number of insertions **InS** of the first capacitor bank. The following screen will appear:

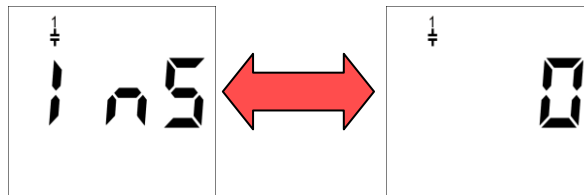

that will be alternately shown with the numerical value.

The next 4 pages show the number of insertions of banks from 2 to 5.

The next displayed page relates to the number of manoeuvres **OP** of the contactor associated to the first capacitor bank. The following screen will appear:

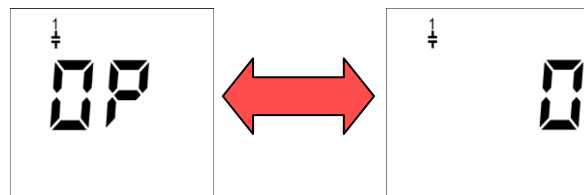

that will be alternately shown with the numerical value.

The next 4 pages show the number of manoeuvres of the contactors associated to banks from 2 to 5.

The next displayed page relates to the number of operating hours **h** of the first capacitor bank. The following screen will appear:

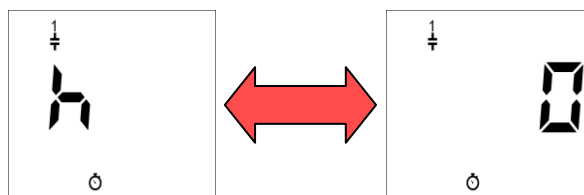

that will be alternately shown with the numerical value.

The next 4 pages show the number of operating hours of banks from 2 to 5.



The next displayed page relates to the estimated reactive power **ES_t** of the first capacitor bank. The following screen will appear:

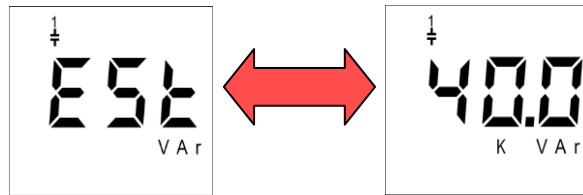

that will be alternately shown with the numerical value.

NOTE: the displayed value does not relate to the set capacitor nominal voltage, but to the actually measured network voltage.



The next 4 pages show the estimated reactive power of banks from 2 to 5.

To quit the Statistics Menu and go back to the Measurement Menu press key  for more than 2sec.

GO BACK TO **USING THE CONTROLLER**

GO BACK TO **CONTENTS**

8.4.2 Alarm statistics

To reach the section devoted to alarm statistics, scroll pages by pressing one of keys ,  or  until the screen relating to the **overvoltage** alarm is displayed:

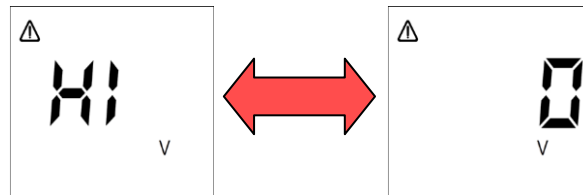

that will be alternately shown with the numerical value corresponding to the alarm activations.

For alarm settings, refer to **Chap. 7.5.1 - Overvoltage alarm threshold** and **Chap. 7.5.2 - Overvoltage alarm delay**.

The next displayed page relates to the **overcurrent** alarm. The following screen will appear:

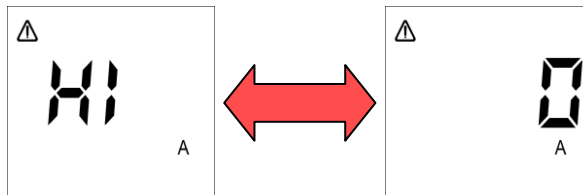

that will be alternately shown with the numerical value corresponding to the alarm activations.

For alarm settings, refer to **Chap. 7.5.3 - Overcurrent alarm threshold** and **Chap. 7.5.4 - Overcurrent alarm delay**.

The next displayed page relates to the **low voltage** alarm. The following screen will appear:

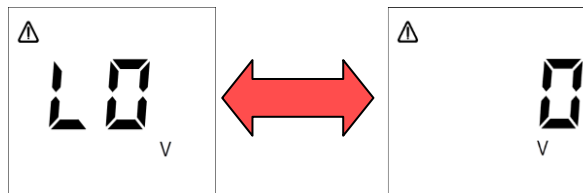

that will be alternately shown with the numerical value corresponding to the alarm activations.

For alarm settings, refer to **Chap. 7.5.5 - Low voltage alarm threshold** and **Chap. 7.5.6 - Low voltage alarm delay**.

The next displayed page relates to the **low current** alarm. The following screen will appear:

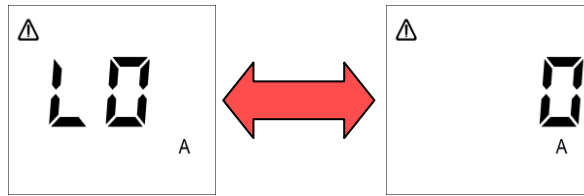

that will be alternately shown with the numerical value corresponding to the alarm activations.

For alarm settings, refer to [Chap. 7.5.7 - Low voltage current threshold](#) and [Chap. 7.5.8 - Low current alarm delay](#).

The next displayed page relates to the high **THDI** alarm. The following screen will appear:

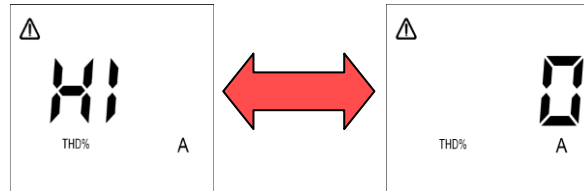

that will be alternately shown with the numerical value corresponding to the alarm activations.

For alarm settings, refer to [Chap. 7.5.11 - THDI alarm threshold](#) and [Chap. 7.5.12 - THDI alarm delay](#).

The next displayed page relates to the high **THDV** alarm. The following screen will appear:

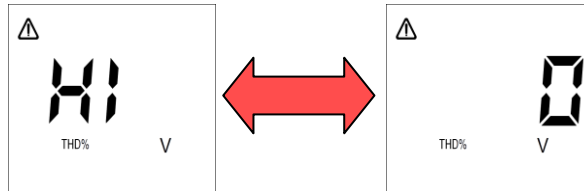

that will be alternately shown with the numerical value corresponding to the alarm activations.

For alarm settings, refer to [Chap. 7.5.9 - THDV alarm threshold](#) and [Chap. 7.5.10 - THDV alarm delay](#).

The next displayed page relates to the **temperature** alarm. The following screen will appear:

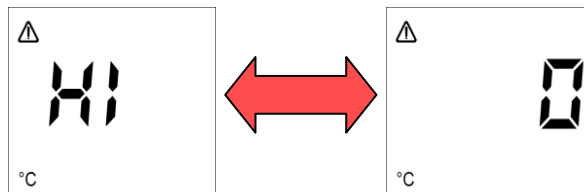

that will be alternately shown with the numerical value corresponding to the alarm activations.

For alarm settings, refer to [Chap. 7.5.13 - Temperature alarm threshold](#) and [Chap. 7.5.14 - Temperature alarm delay](#).

The next displayed page relates to the **power factor overcorrection** alarm. The following screen will appear:

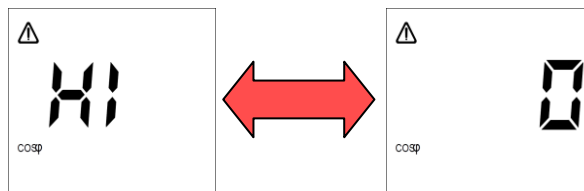

that will be alternately shown with the numerical value corresponding to the alarm activations.

For alarm settings, refer to [Chap. 7.3.1 - Cosphi setpoint](#), [Chap. 7.3.2 - Cosphi setpoint tolerance](#) and to parameter **P.22 – Power factor overcorrection alarm delay** ([Chap. 7.6](#))

The next displayed page relates to the **power factor correction failed** alarm. The following screen will appear:

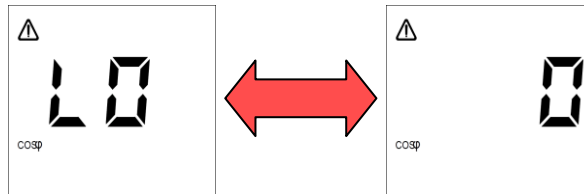

that will be alternately shown with the numerical value corresponding to the alarm activations.

For alarm settings, refer to [Chap. 7.3.1 - Cosphi setpoint](#), [Chap. 7.3.2 - Cosphi setpoint tolerance](#) and to parameter **P.23 – Power factor correction failed alarm delay** ([Chap. 7.6](#)).

The next displayed page relates to the **micro-interruptions** alarm on the network voltage. The following screen will appear:

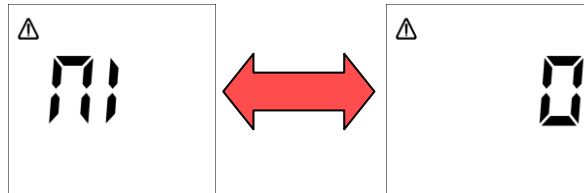

that will be alternately shown with the numerical value corresponding to the alarm activations.

For alarm settings, refer to **P.20 – Micro-interruption duration** ([Chap. 7.6](#)).

To quit the Statistics Menu and go back to the Measurement Menu press key  for more than 2sec.



GO BACK TO [USING THE CONTROLLER](#)

GO BACK TO [CONTENTS](#)



8.5 Alarm management and display

8.5.1 Current alarm menu





The Current Alarm Menu can be accessed from the Measurement Menu by simultaneously pressing keys  and  for more than 2sec. The controller will display the following screen:



Menu can be accessed only if there is at least one current alarm, otherwise pressing the previous keys will not have any effect.

NOTE: no page will be available for non-active alarms, but all the pages of the Current Alarm Menu are described hereinafter in the correct displaying sequence as if all alarms were simultaneously active.

Press key  to reset the alarm (function possible only if **P.13 – Current alarm reset** = “ON”, refer to **Chap. 7.6**).

Now press one of keys  ,  to scroll the pages or one of keys  or  to scroll pages back.

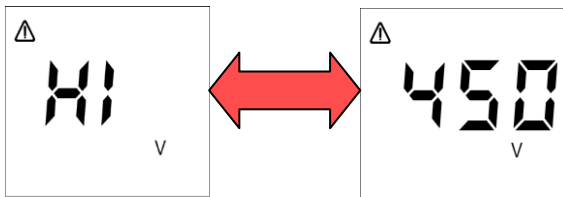

The next displayed page relates to the **overvoltage** alarm that will be alternately shown with the numerical value corresponding to the maximum voltage value measured since alarm activation (450V in the example shown).

For alarm settings, refer to **Chap. 7.5.1 - Overvoltage alarm threshold** and **Chap. 7.5.2 - Overvoltage alarm delay**. For further information on alarm management, refer to **Chap. 8.5.2.1 - Overvoltage alarm**.

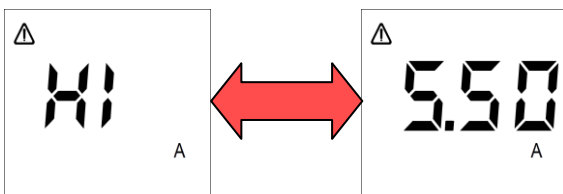

The next displayed page relates to the **overcurrent** alarm that will be alternately shown with the numerical value corresponding to the maximum current value measured since alarm activation (5.5A in the example shown).

For alarm settings, refer to **Chap. 7.5.3 - Overcurrent alarm threshold** and **Chap. 7.5.4 - Overcurrent alarm delay**. For further information on alarm management, refer to **Chap. 8.5.2.2 - Overcurrent alarm**.

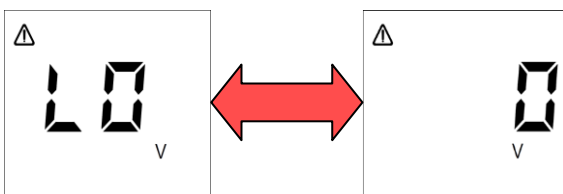

The next displayed page relates to the **low voltage** alarm that will be alternately shown with the numerical value corresponding to the minimum voltage value measured since alarm activation (0V in the example shown).

For alarm settings, refer to **Chap. 7.5.5 - Low voltage alarm threshold** and **Chap. 7.5.6 - Low voltage alarm delay**. For further information on alarm management, refer to **Chap. 8.5.2.3 - Low voltage alarm**.

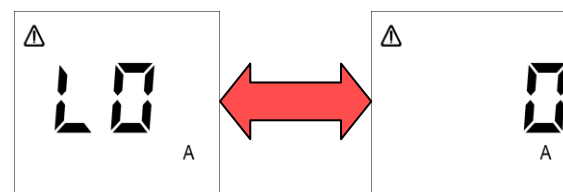

The next displayed page relates to the **low current** alarm that will be alternately shown with the numerical value corresponding to the minimum current value measured since alarm activation (0A in the example shown).

For alarm settings, refer to [Chap. 7.5.7 - Low voltage current threshold](#) and [Chap. 7.5.8 - Low current alarm delay](#). For further information on alarm management, refer to [Chap. 8.5.2.4 - Low current alarm](#).

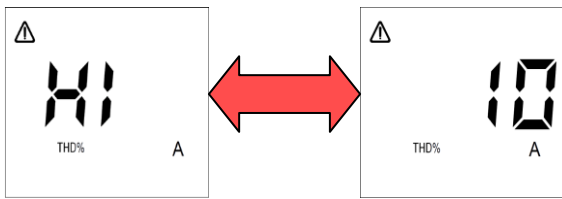

The next displayed page relates to the **THDI** alarm that will be alternately shown with the numerical value corresponding to the maximum % value measured since alarm activation (10% in the example shown).

For alarm settings, refer to [Chap. 7.5.11 - THDI alarm threshold](#) and [Chap. 7.5.12 - THDI alarm delay](#). For further information on alarm management, refer to [Chap. 8.5.2.5 - THDI alarm](#).

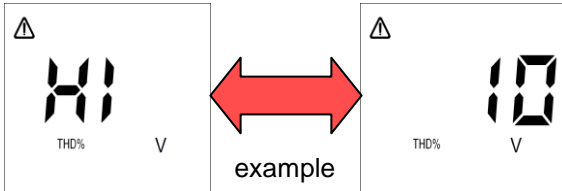

The next displayed page relates to the **THDV** alarm that will be alternately shown with the numerical value corresponding to the maximum % value measured since alarm activation (10% in the shown).

For alarm settings, refer to [Chap. 7.5.9 - THDV alarm threshold](#) and [Chap. 7.5.10 - THDV alarm delay](#). For further information on alarm management, refer to [Chap. 8.5.2.6 - THDV alarm](#).

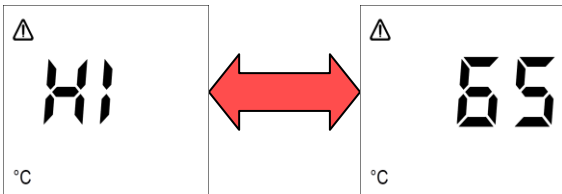

The next displayed page relates to the **temperature** alarm that will be alternately shown with the numerical value corresponding to the maximum temperature value measured since alarm activation (65°C in the example shown).

For alarm settings, refer to [Chap. 7.5.13 - Temperature alarm threshold](#) and [Chap. 7.5.14 - Temperature alarm delay](#). For further information on alarm management, refer to [Chap. 8.5.2.7 - Temperature alarm](#).

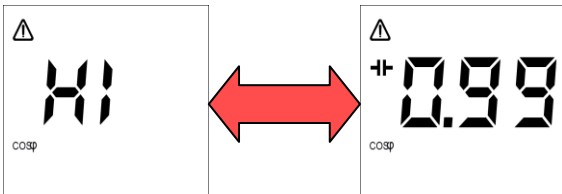

The next displayed page relates to the **power factor overcorrection** alarm that will be alternately shown with the numerical value corresponding to the most capacitive extreme value of the target cosphi range defined by parameters **Cosphi setpoint** and **Cosphi setpoint tolerance** (0.99 capacitive in the example shown).

For alarm settings, refer to [Chap. 7.3.1 - Cosphi setpoint](#), [Chap. 7.3.2 - Cosphi setpoint tolerance](#) and to parameter **P.22 – Power factor overcorrection alarm delay** ([Chap. 7.6](#)). For further information on alarm management, refer to [Chap. 8.5.2.8 - Power factor overcorrection alarm](#).

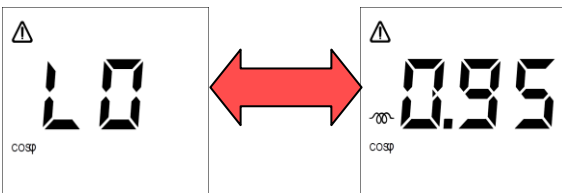

The next displayed page relates to the **power factor correction failed** alarm that will be alternately shown with the numerical value corresponding to the most inductive extreme value of the target cosphi range defined by parameters **Cosphi setpoint** and **Cosphi setpoint tolerance** (0.95 inductive in the example shown).





For alarm settings, refer to [Chap. 7.3.1 - Cosphi setpoint](#), [Chap. 7.3.2 - Cosphi setpoint tolerance](#) and to parameter **P.23 – Power factor correction failed alarm delay** ([Chap. 7.6](#)). For further information on alarm management, refer to [Chap. 8.5.2.9 - Power factor correction failed alarm](#).



The next displayed page relates to the **micro-interruption** alarm on the network voltage that will not be alternately shown with any numerical value.



For alarm settings, refer to **P.20 – Micro-interruption duration** (Chap. 7.6). For further information on alarm management, refer to **Chap. 8.5.2.10 - Micro-interruption alarm**.

The alarm cannot be manually reset. Now press one of keys ,  or  to scroll the pages or one of keys  or  to scroll pages back.

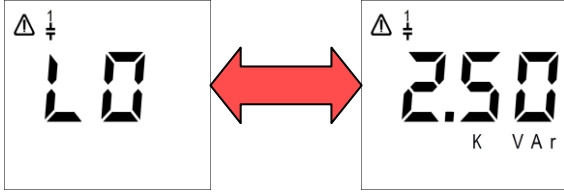

The next 5 displayed pages relate to the **bank n breakage (n=1,2,3,4,5)** alarm. At first the screen relating to bank 1 will be displayed and it will be alternately shown with the numerical value corresponding to the bank estimated reactive power (2.50kVAR in the example shown).

For alarm settings, refer to **P.8 – Presence of blocking reactors**, **P.10 – Fault threshold 1** and **P.12 – Fault threshold 2** (Chap. 7.6). For further information on alarm management, refer to **Chap. 8.5.2.11 - Bank n breakage alarm (n=1,2,3,4,5)**.

This alarm cannot be manually reset from the Current Alarm Menu, but through the Reset Menu (Chap. 8.6 - Reset menu).

Press one of keys ,  or  to scroll the screens of banks from 2 to 5.

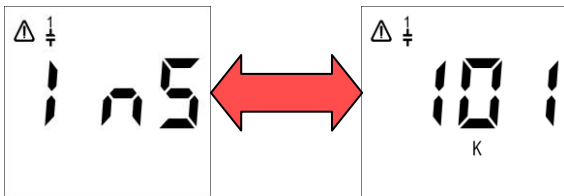

The next 5 displayed pages relate to the alarm **maximum number of bank n insertions (n=1,2,3,4,5)**. At first the screen relating to bank 1 will be displayed and it will be alternately shown with the numerical value (truncated to the thousands) corresponding to the number of bank insertions (101000 in the example shown).

For further information on alarm management, refer to **Chap. 8.5.2.12 - Maximum number of bank n insertions (n=1,2,3,4,5) alarm**.

This alarm cannot be manually reset from the Current Alarm Menu, but through the Reset Menu (Chap. 8.6 - Reset menu).

Press one of keys ,  or  to scroll the screens of banks from 2 to 5.

To quit the Current Alarm Menu and go back to the Measurement Menu press key  for more than 2sec. The cosphi value and the alarm icon will be displayed on the top left. The alarm will be anyway active in the Current Alarm Menu.

GO BACK TO **USING THE CONTROLLER**

GO BACK TO **CONTENTS**

8.5.2 Alarm description

8.5.2.1 Overvoltage alarm

ACTIVATION

The **overvoltage alarm** is activated if the voltage reading of the R5 Controller is above the value defined by parameter **Overvoltage alarm threshold** (Chap. 7.5.1) for a time (in sec) equal to the value of parameter **Overvoltage alarm delay** (Chap. 7.5.2).

MANAGEMENT

The activation of the **overvoltage alarm** triggers the "slow" disconnection of all banks, one at a time, and with a delay between them equal to **P.4 – Transient time during disconnection** (Chap. 7.6). This process takes place in automatic power factor correction mode for all the inserted banks whose **Step n function (n=1,2,3,4,5)** (Chap. 7.2.5) has been set to "CAP" or "ON" and in manual power factor correction mode (refer to **Chap. 8.8 - Manual power factor correction mode**) for all the banks whose status has been set to "ON".

At the same time, the relay outputs set as "ALA" and associated to the "THHV" or "ALL" alarm will be activated unless parameter **P.25 – Alarm masking management** (Chap. 7.6) has been set to mask the alarms under defined operating conditions.

DISPLAYING

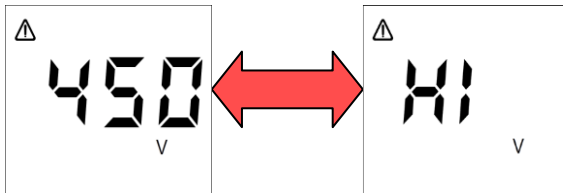

Independent of the current displaying, the alarm will be indicated with the displaying of the relevant page of the **Current alarm menu** that will be alternately shown with the numerical value corresponding to the maximum voltage value measured since alarm activation (450V in the example shown).

The Controller will stay in the above-mentioned screen until:

- key  is pressed for more than 2sec (the alarm is anyway active);
- alarm is deactivated or manually reset by the operator.

Afterwards, the **Measurement Menu** will be automatically displayed and will show, respectively:

- the cosphi value and the alarm icon on the top left. The alarm will be anyway active in the **Current Alarm Menu** (Chap. 8.5.1);
- the cosphi value, but not the alarm icon.

If, parameter **P.25 – Alarm masking management** (Chap. 7.6) has been set to mask the alarms under defined operating conditions, the previous screen will be temporarily displayed for 3sec. The alarm will then automatically go back to the first screen of the **Measurement Menu** by displaying the cosphi value, but not the alarm icon. The alarm will be anyway present in the **Current Alarm Menu**.

STATISTICS

The alarm counter will be increased in the **Statistics Menu** (Chap. 8.4) at every occurrence.

DEACTIVATION

The alarm is automatically deactivated if the voltage reading of the R5 Controller is below the value defined by parameter **Overvoltage alarm threshold** (Chap. 7.5.1) for a time (in sec) equal to the value of parameter **Overvoltage alarm delay** (Chap. 7.5.2).

RESET

Alarm can be manually reset from the **Current Alarm Menu** by pressing key  (function possible only if **P.13 – Current alarm reset** = "ON", refer to **Chap. 7.6**).

8.5.2.2 Overcurrent alarm

ACTIVATION

The **overcurrent alarm** is activated if the current reading of the R5 Controller is above the value defined by parameter **Overvoltage alarm threshold** (Chap. 7.5.3) for a time (in sec) equal to the value of parameter **Overcurrent alarm delay** (Chap. 7.5.4).

MANAGEMENT

The activation of the **overcurrent alarm** triggers the "slow" disconnection of all banks, one at a time, and with a delay between them equal to **P.4 – Transient time during disconnection** (Chap. 7.6). This process takes place in automatic power factor correction mode for all the inserted banks whose **Step n function (n=1,2,3,4,5)** (Chap. 7.2.5) has been set to "CAP" or "ON" and in manual power factor correction mode (refer to Chap. 8.8 - Manual power factor correction mode) for all the banks whose status has been set to "ON".

At the same time, the relay outputs set as "ALA" and associated to the "THHA" or "ALL" alarm will be activated unless parameter **P.25 – Alarm masking management** (Chap. 7.6) has been set to mask the alarms under defined operating conditions.

DISPLAYING

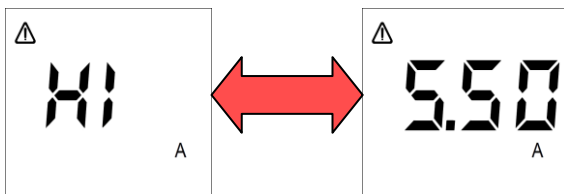

Regardless of the current displaying, the alarm will be indicated with the displaying of the relevant page of the **Current alarm menu** that will be alternately shown with the numerical value corresponding to the maximum current value measured since alarm activation (5.50A in the example shown).

The Controller will stay in the above-mentioned screen until:

- key  is pressed for more than 2sec (the alarm is anyway active);
- alarm is deactivated or manually reset by the operator.

Afterwards, the **Measurement Menu** will be automatically displayed and will show, respectively:

- the cosphi value and the alarm icon on the top left. The alarm will be anyway active in the **Current Alarm Menu** (Chap. 8.5.1);
- the cosphi value, but not the alarm icon.

If, parameter **P.25 – Alarm masking management** (Chap. 7.6) has been set to mask the alarms under defined operating conditions, the previous screen will be temporarily displayed for 3sec. The alarm will then automatically go back to the first screen of the **Measurement Menu** by displaying the cosphi value, but not the alarm icon. The alarm will be anyway present in the **Current Alarm Menu**.

STATISTICS

The alarm counter will be increased in the **Statistics Menu** (Chap. 8.4) at every occurrence.

DEACTIVATION

The alarm is automatically deactivated if the current reading of the R5 Controller stays below the value defined by parameter **Overcurrent alarm threshold** (Chap. 7.5.3) for a time (in sec) equal to the value of parameter **Overcurrent alarm delay** (Chap. 7.5.4).

RESET

Alarm can be manually reset from the **Current Alarm Menu** by pressing key  (function possible only if **P.13 – Current alarm reset** = "ON", refer to Chap. 7.6).

8.5.2.3 Low voltage alarm

ACTIVATION



The **low voltage alarm** is activated if the voltage reading of the R5 Controller stays under the value defined by parameter **Low voltage alarm threshold** (Chap. 7.5.5) for a time (in sec) equal to the value of parameter **Low voltage alarm delay** (Chap. 7.5.6).

MANAGEMENT

The activation of the **low voltage alarm** triggers the "slow" disconnection of all banks, one at a time, and with a delay between them equal to **P.4 – Transient time during disconnection** (Chap. 7.6). This process takes place in automatic power factor correction mode for all the inserted banks whose **Step n function (n=1,2,3,4,5)** (Chap. 7.2.5) has been set to "CAP" or "ON" and in manual power factor correction mode (refer to Chap. 8.8 - Manual power factor correction mode) for all the banks whose status has been set to "ON".

At the same time, the relay outputs set as "ALA" and associated to the "THLV" or "ALL" alarm will be activated unless parameter **P.25 – Alarm masking management** (Chap. 7.6) has been set to mask the alarms under defined operating conditions

DISPLAYING

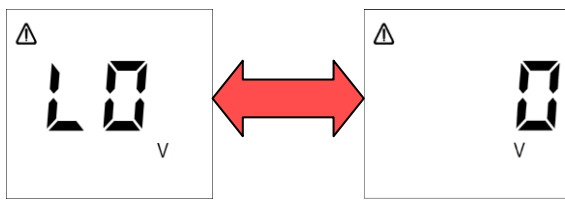

Regardless of the current displaying, the alarm will be indicated with the displaying of the relevant page of the Current alarm menu that will be alternately shown with the numerical value corresponding to the maximum voltage value measured since alarm activation (0V in the example shown).

The Controller will stay in the above-mentioned screen until:

- key  is pressed for more than 2sec (the alarm is anyway active);
- alarm is deactivated or manually reset by the operator.

Afterwards, the Measurement Menu will be automatically displayed and will show, respectively:

- the cosphi value and the alarm icon on the top left. The alarm will be anyway active in the Current Alarm Menu (Chap. 8.5.1);
- the cosphi value, but not the alarm icon.

If, parameter **P.25 – Alarm masking management** (Chap. 7.6) has been set to mask the alarms under defined operating conditions, the previous screen will be temporarily displayed for 3sec. The alarm will then automatically go back to the first screen of the Measurement Menu by displaying the cosphi value, but not the alarm icon. The alarm will be anyway present in the Current Alarm Menu.

STATISTICS

The alarm counter will be increased in the Statistics Menu (Chap. 8.4) at every occurrence.

DEACTIVATION

The alarm is automatically deactivated if the voltage reading of the R5 Controller stays above the value defined by parameter **Low voltage alarm threshold** (Chap. 7.5.5) for a time (in sec) equal to the value of parameter **Low voltage alarm delay** (Chap. 7.5.6).

RESET

Alarm can be manually reset from the Current Alarm Menu by pressing key  (function possible only if **P.13 – Current alarm reset** = "ON", refer to Chap. 7.6).

8.5.2.4 Low current alarm

ACTIVATION

The **low current alarm** is activated:

- o immediately, if the current reading of the R5 Controller goes below the minimum measurable value equal to 0.7% of parameter **CT primary winding** (Chap. 7.1.1) (lower extreme value of the range of parameter **Low current alarm threshold** (Chap. 7.5.7);



- after a time (in sec) equal to parameter **Low current alarm delay** (Chap. 7.5.8), if the current reading of the R5 Controller goes below the value defined by parameter **Low voltage alarm threshold**.

NOTE: if the measured current is equal to or lower than 0.7% of the **CT primary winding**, only the immediate activation will take place.

MANAGEMENT

If the activation of the **low current alarm** is triggered by a current value below the minimum measurable value (0.7% **CT primary winding**) there will be a "slow" disconnection of all banks, one at a time, and with a delay between them equal to **P.4 – Transient time during disconnection** (Chap. 7.6). This process takes place in automatic power factor correction mode for all the inserted banks whose **Step n function (n=1,2,3,4,5)** (Chap. 7.2.5) has been set to "CAP" or "ON" and in manual power factor correction mode (refer to **Chap. 8.8 - Manual power factor correction mode**) for all the banks whose status has been set to "ON".

If the activation of the **low current alarm** is triggered by a higher current value (set through parameter **Low current alarm threshold**) the inserted banks will not be affected in any way.

At the same time, the relay outputs set as "ALA" and associated to the "THLA" or "ALL" alarm will be activated unless parameter **P.25 – Alarm masking management** (Chap. 7.6) has been set to mask the alarms under defined operating conditions

DISPLAYING

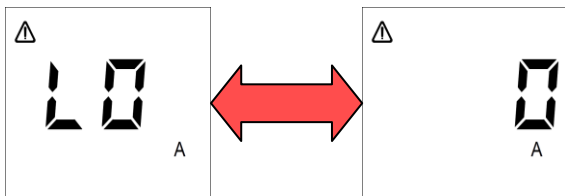

Regardless of the current displaying, the alarm will be indicated with the displaying of the relevant page of the **Current alarm menu** that will be alternately shown with the numerical value corresponding to the minimum current value measured since alarm activation (0A in the example shown).

NOTE: if the measured current is equal to or lower than 0.7% of the **CT primary winding**, only the immediate signal will take place.

The Controller will stay in the above-mentioned screen until:

- key  is pressed for more than 2sec (the alarm is anyway active);
- alarm is deactivated or manually reset by the operator.

Afterwards, the **Measurement Menu** will be automatically displayed and will show, respectively:

- the cosphi value and the alarm icon on the top left. The alarm will be anyway active in the **Current Alarm Menu** (Chap. 8.5.1);
- the cosphi value, but not the alarm icon.

If, parameter **P.25 – Alarm masking management** (Chap. 7.6) has been set to mask the alarms under defined operating conditions, the previous screen will be temporarily displayed for 3sec. The alarm will then automatically go back to the first screen of the **Measurement Menu** by displaying the cosphi value, but not the alarm icon. The alarm will be anyway present in the **Current Alarm Menu**.

STATISTICS

The alarm counter will be increased in the **Statistics Menu** (Chap. 8.4) at every occurrence.

DEACTIVATION

The alarm is automatically deactivated if the current reading of the R5 Controller stays above the value defined by parameter **Low current alarm threshold** (Chap. 7.5.7) for a time (in sec) equal to the value of parameter **Low current alarm delay** (Chap. 7.5.8).

NOTE: if the activation has been caused by a measured current value equal to or lower than 0.7% of the **CT primary winding**, as soon as the current value goes above this threshold (and not necessarily above the value defined by parameter **Low current alarm threshold**), the controller will start inserting capacitor banks again based on the **Step n function (n=1,2,3,4,5)** they are associated to and on the automatic or manual power factor correction mode.

RESET



Alarm can be manually reset from the Current Alarm Menu by pressing key  (function possible only if **P.13 – Current alarm reset** = “ON”, refer to **Chap. 7.6**).

8.5.2.5 THDI alarm

ACTIVATION

The **THDI alarm** is activated if the THDI% value stays above the value defined by parameter **THDI alarm threshold** **Chap. 7.5.11** for a time (in sec) equal to the value of parameter **THDI alarm delay** **Chap. 7.5.12**.

MANAGEMENT

The activation of the **THDI alarm** triggers the "slow" disconnection of all banks, one at a time, and with a delay between them equal to **P.4 – Transient time during disconnection** (**Chap. 7.6**).

This process takes place in automatic power factor correction mode for all the inserted banks whose **Step n function (n=1,2,3,4,5)** **Chap. 7.2.5** has been set to “CAP” or “ON” and in manual power factor correction mode (refer to **Chap. 8.8 - Manual power factor correction mode**) for all the banks whose status has been set to "ON".

At the same time, the relay outputs set as "ALA" and associated to the "THD%A" or "ALL" alarm will be activated unless parameter **P.25 – Alarm masking management** (**Chap. 7.6**) has been set to mask the alarms under defined operating conditions.

DISPLAYING

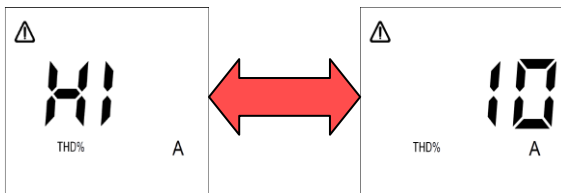

Regardless of the current displaying, the alarm will be indicated with the displaying of the relevant page of the Current alarm menu that will be alternately shown with the numerical value corresponding to the maximum THDI% value measured since alarm activation (10% in the example shown).

The Controller will stay in the above-mentioned screen until:

- key  is pressed for more than 2sec (the alarm is anyway active);
- alarm is deactivated or manually reset by the operator.

Afterwards, the Measurement Menu will be automatically displayed and will show, respectively:

- the cosphi value and the alarm icon on the top left. The alarm will be anyway active in the Current Alarm Menu (**Chap. 8.5.1**);
- the cosphi value, but not the alarm icon.

If, parameter **P.25 – Alarm masking management** (**Chap. 7.6**) has been set to mask the alarms under defined operating conditions, the previous screen will be temporarily displayed for 3sec. The alarm will then automatically go back to the first screen of the Measurement Menu by displaying the cosphi value, but not the alarm icon. The alarm will be anyway present in the Current Alarm Menu.

STATISTICS

The alarm counter will be increased in the Statistics Menu (**Chap. 8.4**) at every occurrence.

DEACTIVATION

The alarm is automatically deactivated if the THDI% value stays below the value defined by parameter **THDI alarm threshold** **Chap. 7.5.11** for a time (in sec) equal to the value of parameter **THDI alarm delay** **Chap. 7.5.12**.

RESET

Alarm can be manually reset from the Current Alarm Menu by pressing key  (function possible only if **P.13 – Current alarm reset** = “ON”, refer to **Chap. 7.6**).

8.5.2.6 THDV alarm

ACTIVATION



The **THDV alarm** is activated if the THDV% value stays above the value defined by parameter **THDV alarm threshold** [Chap. 7.5.9](#) for a time (in sec) equal to the value of parameter **THDV alarm delay** [Chap. 7.5.10](#).

MANAGEMENT

The activation of the **THDV alarm** triggers the "slow" disconnection of all banks, one at a time, and with a delay between them equal to **P.4 – Transient time during disconnection** ([Chap. 7.6](#)).

This process takes place in automatic power factor correction mode for all the inserted banks whose **Step n function (n=1,2,3,4,5)** [Chap. 7.2.5](#) has been set to "CAP" or "ON" and in manual power factor correction mode (refer to [Chap. 8.8 - Manual power factor correction mode](#)) for all the banks whose status has been set to "ON".

At the same time, the relay outputs set as "ALA" and associated to the "THD%V" or "ALL" alarm will be activated unless parameter **P.25 – Alarm masking management** ([Chap. 7.6](#)) has been set to mask the alarms under defined operating conditions.

DISPLAYING

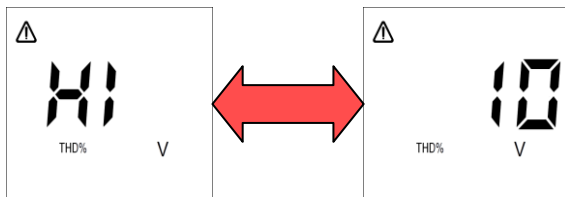

Regardless of the current displaying, the alarm will be indicated with the displaying of the relevant page of the Current alarm menu that will be alternately shown with the numerical value corresponding to the maximum THDV% value measured since alarm activation (10% in the example shown).

The Controller will stay in the above-mentioned screen until:

- key  is pressed for more than 2sec (the alarm is anyway active);
- alarm is deactivated or manually reset by the operator.

Afterwards, the Measurement Menu will be automatically displayed and will show, respectively:

- the cosphi value and the alarm icon on the top left. The alarm will be anyway active in the Current Alarm Menu ([Chap. 8.5.1](#));
- the cosphi value, but not the alarm icon.

If, parameter **P.25 – Alarm masking management** ([Chap. 7.6](#)) has been set to mask the alarms under defined operating conditions, the previous screen will be temporarily displayed for 3sec. The alarm will then automatically go back to the first screen of the Measurement Menu by displaying the cosphi value, but not the alarm icon. The alarm will be anyway present in the Current Alarm Menu.

STATISTICS

The alarm counter will be increased in the Statistics Menu ([Chap. 8.4](#)) at every occurrence.

DEACTIVATION

The alarm is automatically deactivated if the THDV% value stays below the value defined by parameter **THDV alarm threshold** [Chap. 7.5.9](#) for a time (in sec) equal to the value of parameter **THDV alarm delay** [Chap. 7.5.10](#).

RESET

Alarm can be manually reset from the Current Alarm Menu by pressing key  (function possible only if **P.13 – Current alarm reset** = "ON", refer to [Chap. 7.6](#)).

8.5.2.7 Temperature alarm

ACTIVATION

The **temperature alarm** is activated if the temperature value read by the R5 Controller stays above the value defined by parameter **Temperature alarm threshold** [Chap. 7.5.13](#) for a time (in sec) equal to the value of parameter **Temperature alarm delay** [Chap. 7.5.14](#).

MANAGEMENT

The activation of the **temperature alarm** triggers the "slow" disconnection of all banks, one at a time, and with a delay between them equal to **P.4 – Transient time during disconnection** (Chap. 7.6).

This process takes place in automatic power factor correction mode for all the inserted banks whose **Step n function (n=1,2,3,4,5)** (Chap. 7.2.5) has been set to "CAP" or "ON" and in manual power factor correction mode (refer to Chap. 8.8 - **Manual power factor correction mode**) for all the banks whose status has been set to "ON".

At the same time, the relay outputs set as "ALA" and associated to the "TMP°C" or "ALL" alarm will be activated unless parameter **P.25 – Alarm masking management** (Chap. 7.6) has been set to mask the alarms under defined operating conditions.

DISPLAYING

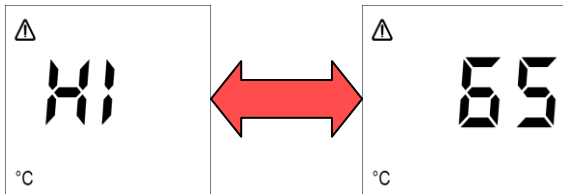

Regardless of the current displaying, the alarm will be indicated with the displaying of the relevant page of the **Current alarm menu** that will be alternately shown with the maximum value measured since alarm activation (65°C in the example shown).

The Controller will stay in the above-mentioned screen until:

- key  is pressed for more than 2sec (the alarm is anyway active);
- alarm is deactivated or manually reset by the operator.

Afterwards, the **Measurement Menu** will be automatically displayed and will show, respectively:

- the cosphi value and the alarm icon on the top left. The alarm will be anyway active in the **Current Alarm Menu** (Chap. 8.5.1);
- the cosphi value, but not the alarm icon.

If, parameter **P.25 – Alarm masking management** (Chap. 7.6) has been set to mask the alarms under defined operating conditions, the previous screen will be temporarily displayed for 3sec. The alarm will then automatically go back to the first screen of the **Measurement Menu** by displaying the cosphi value, but not the alarm icon. The alarm will be anyway present in the **Current Alarm Menu**.

STATISTICS

The alarm counter will be increased in the **Statistics Menu** (Chap. 8.4) at every occurrence.

DEACTIVATION

The alarm is automatically deactivated if the temperature value stays below the value defined by parameter **Temperature alarm threshold** (Chap. 7.5.13) for a time (in sec) equal to the value of parameter **Temperature alarm delay** (Chap. 7.5.14).

RESET

Alarm can be manually reset from the **Current Alarm Menu** by pressing key  (function possible only if **P.13 – Current alarm reset** = "ON", refer to Chap. 7.6).

8.5.2.8 Power factor overcorrection alarm

ACTIVATION

The **power factor overcorrection alarm** is activated if the cosphi value stays above the numerical value corresponding to the most capacitive extreme value of the target cosphi defined by parameters **Cosphi setpoint** (Chap. 7.3.1) and **Cosphi setpoint tolerance** (Chap. 7.3.2) for a time (in hours) equal to the value of parameter **P.22 - Power factor overcorrection alarm delay** (Chap. 7.6).

NOTE: the power factor overcorrection may be caused by:

- setting **Step n function** (Chap.7.2.5) = "ON" for an excessive number of batteries;
- incorrect setting of the target cosphi range with respect to the type of load on the system;



- incorrect setting of the parameters related to the connections and the equipment in the Setup Menu.

MANAGEMENT

The activation of the **power factor overcorrection alarm** will not affect the status of the inserted banks.

The relay outputs set as "ALA" and associated to the "Hlcosphi" or "ALL" alarm will be activated unless parameter **P.25 – Alarm masking management** (Chap. 7.6) has been set to mask the alarms under defined operating conditions.

DISPLAYING

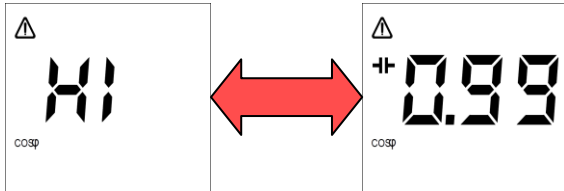

Regardless of the current displaying, the alarm will be indicated with the displaying of the relevant page of the Current alarm menu that will be alternately shown with the numerical value corresponding to the most capacitive extreme value of the target cosphi range defined by parameters **Cosphi setpoint** and **Cosphi setpoint tolerance** (0.99 capacitive in the example shown).

The Controller will stay in the above-mentioned screen until:

- key  is pressed for more than 2sec (the alarm is anyway active);
- alarm is deactivated or manually reset by the operator.

Afterwards, the Measurement Menu will be automatically displayed and will show, respectively:

- the cosphi value and the alarm icon on the top left. The alarm will be anyway active in the Current Alarm Menu (Chap. 8.5.1);
- the cosphi value, but not the alarm icon.

If, parameter **P.25 – Alarm masking management** (Chap. 7.6) has been set to mask the alarms under defined operating conditions, the previous screen will be temporarily displayed for 3sec. The alarm will then automatically go back to the first screen of the Measurement Menu by displaying the cosphi value, but not the alarm icon. The alarm will be anyway present in the Current Alarm Menu.

STATISTICS

The alarm counter will be increased in the Statistics Menu (Chap. 8.4) at every occurrence.

DEACTIVATION

The alarm is automatically deactivated as soon as the cosphi value goes below the numerical value corresponding to the most capacitive extreme value of the target cosphi range defined by parameters **Cosphi setpoint** (Chap. 7.3.1) and **Cosphi setpoint tolerance** (Chap. 7.3.2).

RESET

Alarm can be manually reset from the Current Alarm Menu by pressing key  (function possible only if **P.13 – Current alarm reset** = “ON”, refer to Chap. 7.6).

8.5.2.9 Power factor correction failed alarm

ACTIVATION

The **power factor correction failed alarm** is activated if the cosphi value stays below the numerical value corresponding to the most inductive extreme value of the target cosphi range defined by parameters **Cosphi setpoint** (Chap. 7.3.1) and **Cosphi setpoint tolerance** (Chap. 7.3.2) for a time (in hours) equal to the value of parameter **P.23 – Power factor correction failed alarm delay** (Chap. 7.6).

NOTE: the alarm condition may be caused by:

- incorrect sizing of the power factor correction equipment with respect to the system load;
- presence of degraded or broken batteries;
- incorrect setting of the parameters related to the power factor correction, the connections and the equipment in the Setup Menu.



MANAGEMENT

The activation of the **power factor correction failed alarm** will not affect the status of the inserted banks.

The relay outputs set as "ALA" and associated to the "LOcosphi" or "ALL" alarm will be activated unless parameter **P.25 – Alarm masking management** (Chap. 7.6) has been set to mask the alarms under defined operating conditions.

DISPLAYING

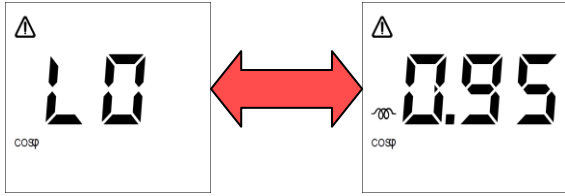

Regardless of the current displaying, the alarm will be indicated with the displaying of the relevant page of the Current alarm menu that will be alternately shown with the numerical value corresponding to the most inductive extreme value of the target cosphi range defined by parameters **Cosphi setpoint** and **Cosphi setpoint tolerance** (0.95 inductive in the example shown).

The Controller will stay in the above-mentioned screen until:

- key  is pressed for more than 2sec (the alarm is anyway active);
- alarm is deactivated or manually reset by the operator.

Afterwards, the Measurement Menu will be automatically displayed and will show, respectively:

- the cosphi value and the alarm icon on the top left. The alarm will be anyway active in the Current Alarm Menu (Chap. 8.5.1);
- the cosphi value, but not the alarm icon.

If, parameter **P.25 – Alarm masking management** (Chap. 7.6) has been set to mask the alarms under defined operating conditions, the previous screen will be temporarily displayed for 3sec. The alarm will then automatically go back to the first screen of the Measurement Menu by displaying the cosphi value, but not the alarm icon. The alarm will be anyway present in the Current Alarm Menu.

STATISTICS

The alarm counter will be increased in the Statistics Menu (Chap. 8.4) at every occurrence.

DEACTIVATION

The alarm is automatically deactivated as soon as the cosphi value goes above the numerical value corresponding to the most inductive extreme value of the target cosphi range defined by parameters **Cosphi setpoint** (Chap. 7.3.1) and **Cosphi setpoint tolerance** (Chap. 7.3.2).

RESET

Alarm can be manually reset from the Current Alarm Menu by pressing key  (function possible only if **P.13 – Current alarm reset** = "ON", refer to Chap. 7.6).

8.5.2.10 Micro-interruption alarm

ACTIVATION

The **micro-interruption** alarm is activated if the voltmetric input of the R5 Controller stays below 10% of the nominal value defined by parameter **VT secondary winding** (Chap. 7.1.8) for a time (in msec) equal to the value of parameter **P.20 – Micro-interruption duration** (Chap. 7.6).

MANAGEMENT

The activation of the **micro-interruption alarm** triggers the immediate and simultaneous disconnection of all banks. This process takes place in automatic power factor correction mode for all the inserted banks whose **Step n function** (n=1,2,3,4,5) (Chap. 7.2.5) has been set to "CAP" or "ON" and in manual power factor correction mode (refer to Chap. 8.8 - Manual power factor correction mode) for all the banks whose status has been set to "ON".



DISPLAYING

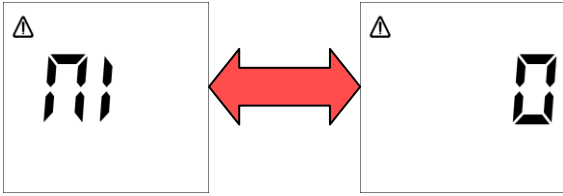

Regardless of the current displaying, the alarm will be indicated with the displaying of the relevant page of the Current alarm menu that will be alternately shown with the numerical value corresponding to alarm activations.

The Controller will stay in the above-mentioned screen until:

- key  is pressed for more than 2sec (the alarm is anyway active);
- alarm is deactivated.

Afterwards, the Measurement Menu will be automatically displayed and will show, respectively:

- the cosphi value and the alarm icon on the top left. The alarm will be anyway active in the Current Alarm Menu ([Chap. 8.5.1](#));
- the cosphi value, but not the alarm icon.

If, parameter **P.25 – Alarm masking management** ([Chap. 7.6](#)) has been set to mask the alarms under defined operating conditions, the previous screen will be temporarily displayed for 3sec. The alarm will then automatically go back to the first screen of the Measurement Menu by displaying the cosphi value, but not the alarm icon. The alarm will be anyway present in the Current Alarm Menu.

STATISTICS

The alarm counter will be increased in the Statistics Menu ([Chap. 8.4](#)) at each occurrence not causing the complete powering-off of the R5 Controller.

DEACTIVATION

The alarm is automatically deactivated after a time equal to the **Re-connection time** [Chap.7.2.3](#).

RESET

This alarm cannot be manually reset from the Current Alarm Menu.

8.5.2.11 Bank n breakage alarm (n=1,2,3,4,5)

ACTIVATION

The alarm **bank n breakage (n=1,2,3,4,5)** is activated if bank n estimated reactive power decreases by a percentage equal to or higher than **P.10 – Fault threshold 1** (if **P.8 – Presence of blocking reactors** = “OFF”) or **P.12 – Fault threshold 2** (if **P.8 – Presence of blocking reactors** = “ON”). For further details, refer to ([Chap. 7.6](#)).

MANAGEMENT

The activation of **bank n breakage alarm (n=1,2,3,4,5)** triggers the immediate disconnection of bank n. This process takes place in automatic power factor correction mode for all the inserted banks whose **Step n function (n=1,2,3,4,5)** [Chap. 7.2.5](#) has been set to “CAP” or “ON” and in manual power factor correction mode (refer to [Chap. 8.8 - Manual power factor correction mode](#)) for all the banks whose status has been set to "ON".

DISPLAYING

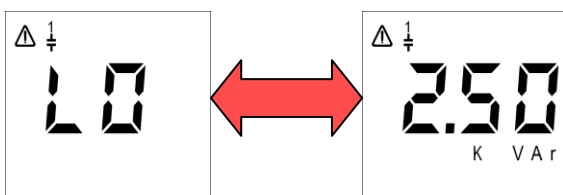

Regardless of the current displaying, the alarm will be indicated with the displaying of the relevant page of the Current alarm menu that will be alternately shown with the numerical value corresponding to bank estimated reactive power (in the example, bank 1 is broken with an estimated power of 2.50kVAr).

The Controller will stay in the above-mentioned screen until key  is pressed for more than 2sec (the alarm is anyway active). Afterwards, the Measurement Menu will be automatically displayed and will show the cosphi value and the alarm icon on the top left. The alarm will be anyway active in the Current Alarm Menu ([Chap. 8.5.1](#)).



If, parameter **P.25 – Alarm masking management** (Chap. 7.6) has been set to mask the alarms under defined operating conditions, the previous screen will be temporarily displayed for 3sec. The alarm will then automatically go back to the first screen of the Measurement Menu by displaying the cosphi value, but not the alarm icon. The alarm will be anyway present in the Current Alarm Menu.

STATISTICS

There is not a specific statistics for this alarm, in the Statistics Menu (Chap. 8.4) it will nevertheless possible to display the estimated reactive power value of bank n.

DEACTIVATION

The alarm cannot be deactivated, once a bank is declared as broken, it will not be possible to use it again on the R5 Controller.

RESET

This alarm cannot be manually reset from the Current Alarm Menu. Bank n and, consequently, the relevant breakage alarm can be reset through the Reset Menu (Chap. 8.6).

8.5.2.12 Maximum number of bank n insertions (n=1,2,3,4,5) alarm

ACTIVATION

The alarm **maximum number of bank n insertions (n=1,2,3,4,5)** is activated if the number of insertions **InS** of bank n reaches the maximum number equal to 100000.

MANAGEMENT

The activation of the alarm **maximum number of bank n insertions (n=1,2,3,4,5)** will not affect the status of the inserted banks.

DISPLAYING

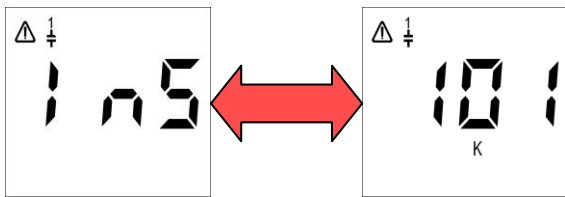

Regardless of the current displaying, the alarm will be indicated with the displaying of the relevant page of the Current alarm menu that will be alternately shown with the numerical value (truncated to the thousands) corresponding to bank number of insertions (in the example, the number of insertions for bank 1 has been exceeded and there is a value of 101000 insertions).

The Controller will stay in the above-mentioned screen until key  is pressed for more than 2sec (the alarm is anyway active). Afterwards, the Measurement Menu will be automatically displayed and will show the cosphi value and the alarm icon on the top left. The alarm will be anyway active in the Current Alarm Menu (Chap. 8.5.1).

If, parameter **P.25 – Alarm masking management** (Chap. 7.6) has been set to mask the alarms under defined operating conditions, the previous screen will be temporarily displayed for 3sec. The alarm will then automatically go back to the first screen of the Measurement Menu by displaying the cosphi value, but not the alarm icon. The alarm will be anyway present in the Current Alarm Menu.

STATISTICS

There is not a specific statistics for this alarm, in the Statistics Menu (Chap. 8.4) it will nevertheless possible to display the number of insertions of bank n.

DEACTIVATION

Alarm cannot be deactivated.

RESET

This alarm cannot be manually reset from the Current Alarm Menu. Bank n or directly the number of insertions of bank n can be reset and, consequently, the relevant alarm for the maximum number of insertions can be reset through the Reset Menu (Chap. 8.6).

GO BACK TO **USING THE CONTROLLER**

GO BACK TO **CONTENTS**

8.6 Reset menu



Access the Setup Menu by pressing  for at least 2sec. The following screen will appear:



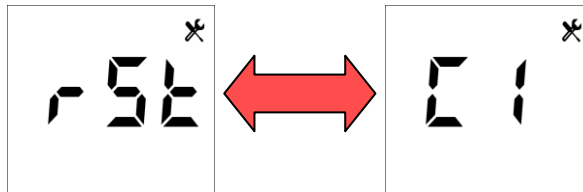

Scroll the menu using keys  or  until displaying the Reset Menu:



that will be alternately shown with the string “C1”, corresponding to **Bank 1 Parameters/Statistics**.

Access parameter editing mode by pressing key  or key , then use the same keys to scroll the values until reaching the desired parameter.

To confirm the reset of the selected parameter, press key  for at least 2sec.

Press key  for 2sec to quit the Setup Menu.

8.6.1 Bank n parameters/statistics reset (n=1,2,3,4,5)



If you want to reset bank n, scroll the suggested values until reaching parameter “**Cn**” flashing (with n=1,2,3,4,5). The screens relating to bank 1 are described hereinafter.

The reset of **Bank n Parameters/Statistics** will cause:

- the reset to 0 of the number of insertions **Ins** of bank n (then any **Maximum number of bank n insertion alarm** will be reset as well [Chap. 8.5.2.12](#));
- the reset to 0 of the operating hours **h** of bank n;
- the reset to 0 of the number of switching manoeuvres **OP** of the contactor associated to bank n;
- the reset to the default “CAP” value for the parameter **Step n function** [Chap. 7.2.5](#);
- the reset of the estimated reactive power value **ES_t** of bank n to the nominal value defined by **Step n power** [Chap. 7.2.6](#) (as a consequence, any **Bank n breakage alarm** will be reset as well [Chap. 8.5.2.11](#)).

Confirm the reset of the parameter by pressing key  for at least 2sec.

The controller will automatically move to the Setup Menu page relating to parameter **Step n power** [Chap. 7.2.6](#):

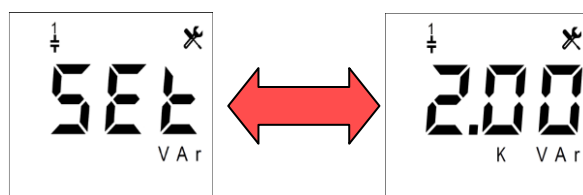



that will be alternately shown with the previously set value (2kVAr in the example shown). Edit, if necessary, the suggested value. If the controller is installed on a Ducati energia power factor correction equipment, the value to be entered is the one specified on equipment plate (for the entering mode of the numerical value, refer to **Chap. 7.8 - Numerical value entering modes**).

8.6.2 Bank n contactor switching manoeuvres number reset (n=1,2,3,4,5)

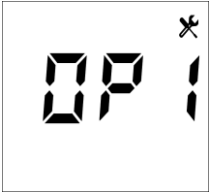

If you want to reset bank n, scroll the suggested values until reaching parameter **“OPn”** flashing (with n=1,2,3,4,5). The example screen relates to bank 1.

The reset of the **bank n contactor switching manoeuvres number** will reset only the **OP** parameter of the contactor associated to bank n.

Confirm the reset of the parameter by pressing key  for at least 2sec. The controller will automatically move to the first **Setup Menu** page.

8.6.3 Alarm reset



Scroll the suggested values until reaching parameter **“ALA”** flashing.

The **alarm** reset will result in the reset of the occurrence counters of all the alarms displayed in the **Statistics Menu** (**Chap. 8.4**).

Confirm the reset of the parameter by pressing key  for at least 2sec. The controller will automatically move to the first **Setup Menu** page.

8.6.4 Average value reset



Scroll the suggested values until reaching parameter **“AVG”** flashing.

The reset of **average values** will result in the reset of the average values of voltage, current, reactive power, active power, apparent power, cosphi, PF and temperature measurements as well as of the daily, weekly and monthly cosphi average value.

NOTE: **average values** are only available via the communication interfaces RS485 and Radio 868MHz for the provided models.

Confirm the reset of the parameter by pressing key  for at least 2sec. The controller will automatically move to the first **Setup Menu** page.

8.6.5 Minimum and maximum value reset



Scroll the suggested values until reaching parameter **“PEA”** flashing.

The reset of **maximum and minimum values** will result in the reset of the maximum and minimum values of voltage, current, reactive power, active power, apparent power, cosphi, PF and temperature measurements.

NOTE: **minimum and maximum values** are only available via the communication interfaces RS485 and Radio 868MHz for the provided models.

Confirm the reset of the parameter by pressing key  for at least 2sec. The controller will automatically move to the first **Setup Menu** page.



8.6.6 Auto-acquisition reset



Scroll the suggested values until reaching parameter “**ACq**” flashing:

The **auto-acquisition** reset will force a restart of R5 Controller, followed by an automatic check procedure of connection and reactive power of banks, that will be:

- **complete** (for further details, refer to [Chap. 6.1 - Complete auto-acquisition](#)) if all the values of parameters **Step n power (n=1,2,3,4,5)** [Chap. 7.2.6](#) are equal to zero;
- **reduced** (for further details, refer to [Chap. 6.2 - Reduced auto-acquisition](#)) if at least one of the values of parameters **Step n power (n=1,2,3,4,5)** [Chap. 7.2.6](#) is not equal to zero;

Confirm the reset of the parameter by pressing key  for at least 2sec.

The controller will be automatically restarted and the **Complete** or **reduced auto-acquisition** procedure will be performed (for further details, refer respectively to [Chap. 6.1](#) and [Chap. 6.2](#)).

8.6.7 Reset to factory settings



Scroll the suggested values until reaching parameter “**ALL**” flashing:

The **Reset to factory settings** will reset all parameter statuses to the default status specified in [Chap. 7.7 - Parameter range and default values](#) and will force a restart of the R5 Controller followed by a **Complete auto-acquisition** procedure (for further details, refer to [Chap. 6.1](#)).

Confirm the reset of the parameter by pressing key  for at least 2sec.

The controller will be automatically restarted and the **Complete auto-acquisition** procedure will be performed (for further details, refer to [Chap. 6.1](#)).

GO BACK TO [USING THE CONTROLLER](#)

GO BACK TO [CONTENTS](#)

8.7 Communication interfaces

8.7.1 RS485 serial connection

NOTE: the RS485 serial connection is optional; refer to [Chap. 1 - R5 MODELS](#) for the list of models with this connection.

For further details on interface connection, refer to [Chap. 5.2 - RS485 serial connection](#).

For detailed information on configuration parameter setting, refer to [Chap. 7.4 - Communication interface settings](#).

For all the information on Modbus-RTU and ASCII Ducbus protocol specifications, refer to the documents available at the following link: <https://www.ducatienergia.com/product.php?lang=en&id=8&cat=13&product=89>

8.7.2 868Mhz Radio Interface

NOTE: the 868Mhz Radio interface is optional; refer to [Chap. 1 - R5 MODELS](#) for the list of models with this connection.

To use the interface, a Energy Bridge device by Ducati Energia is required. The available documents can be consulted at the following link: www.ducatienergia.com.

For detailed information on configuration parameter settings, refer to [P.16 - 868MHz radio address](#) and [P.17 - 868MHz radio channel](#). (refer to [Chap. 7.6](#)).

8.7.3 NFC

The NFC interface is present on all R5 models and its antenna is positioned in the bottom right area of the display of R5 Controller.

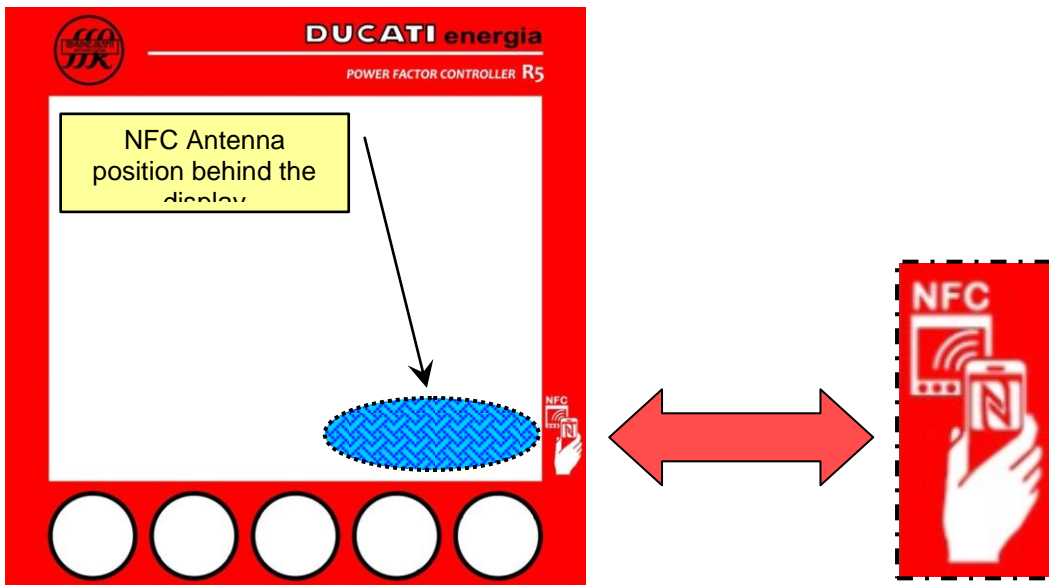

It is possible to interact with the R5 Controller through the interface with Android devices with installed Ducati Smart Energy App, which can be downloaded by framing the QR-code at the side.

For any use information, refer to the on-line guide of the App:
<https://play.google.com/store/apps/details?id=it.ducatienergia.smartenergy>



GO BACK TO [USING THE CONTROLLER](#)

GO BACK TO [CONTENTS](#)

8.8 Manual power factor correction mode

The manual operating mode allows to manually arm and disarm capacitor banks in case some checks have to be made on the equipment.

The manual power factor correction mode can be activated:

- setting parameter **Manual power factor correction mode** = "ON" in Setup Menu ([Chap.7.2.2](#));
- from any page of the Measurement Menu, by pressing key  for at least 2sec;
- if the controller is waiting to perform the auto-acquisition procedure with no current or, in case of current, before setting the parameter **CT primary winding** (refer to **Complete auto-acquisition** [Chap. 6.1](#) and **Reduced auto-acquisition** [Chap. 6.2](#)), by keeping key  pressed for at least 2sec.

If the manual power factor correction mode is activated before the auto-acquisition procedure, the corresponding pages of the Setup Menu will prompt user to set the **CT primary winding**:

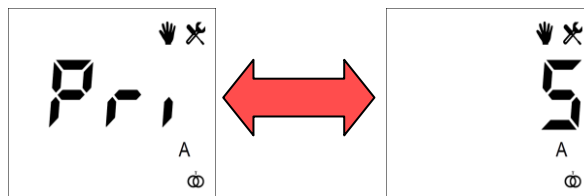

of the **CT secondary winding**:

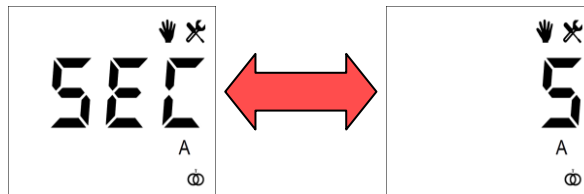

and, if necessary, the **Capacitor nominal voltage**:

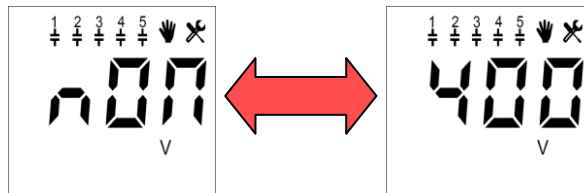





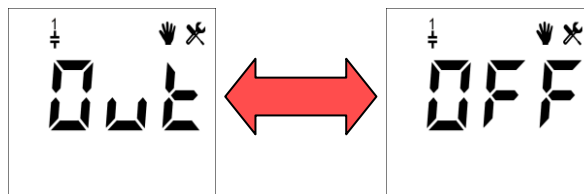

For further information on the entering procedure of the previous parameters, refer to [Chap. 7 - SETTINGS](#). The user will have then to set the output status by confirming or editing it in the pages displayed after.

Bank status setting

At first the page relating to bank 1 will be displayed alternately with the current status ("OFF" or "ON").



To confirm current status, press key . To edit status, access the edit mode by pressing key  or key , the display will show only the value of the current parameter flashing. Press keys  or  to scroll the possible values [ON; OFF]. The change in progress can be cancelled by pressing key .

To confirm, press key .



WARNING: by confirming the value, the new setting will be immediately implemented and the previous will be overwritten. If a bank for which the discharge time has not been elapsed is set to "ON", the insertion will take place after time elapsing.

Then the pages relating to banks from 2 to 5 will be displayed.

NOTE: to confirm also in manual mode the status of all outputs as before the activation of manual mode, press key



Once sequence is completed, the R5 Controller will move to the cosphi measurement page, signalling that the manual power factor correction mode is active through the dedicated icon coming on:



The manual power factor correction mode can be deactivated:

- from any displaying page of measurements by pressing key  for at least 2sec;
- by accessing the Setup Menu and setting to "OFF" the **Manual power factor correction mode** parameter. Refer to [Chap. 8.8](#) for further details.

NOTE. if the **Manual power factor correction mode** had been accessed before auto-acquisition, when quitting it the controller will perform the standard auto-acquisition procedure specified in **Complete auto-acquisition** [Chap. 6.1](#) and **Reduced auto-acquisition** [Chap. 6.2](#).

GO BACK TO [USING THE CONTROLLER](#)

GO BACK TO [CONTENTS](#)

8.9 Presence of blocking reactors

If controller is used on an equipment provided with capacitor banks with blocking reactors (or equivalent devices), make the following settings:

1.)

Enter, for the **Capacitor nominal voltage** parameter [Chap. 7.2.1](#), a value corresponding to network nominal voltage.

For example, if network nominal voltage is 400V, enter "400".

2.)

Enter for parameters **Step n power (n=1,2,3,4,5)** [Chap. 7.2.6](#) the values corresponding to capacitor equivalent reactive power at network voltage and not the relevant nominal value.

For example, if the capacitor nominal voltage specified on the plate is 5kVAR at a nominal voltage of 500V and the network nominal voltage is instead 400V, set the parameter to 4kVAR by entering the value "4.00k".

3.)

Enable parameter **P.8 – Presence of blocking reactors** by setting it to "ON" and, if necessary, edit the parameters **P.11 – Degradation threshold 2** and **P.12 – Fault threshold 2**. For further details, refer to [Chap. 7.6](#).

GO BACK TO [USING THE CONTROLLER](#)

GO BACK TO [CONTENTS](#)



8.10 Firmware update

R5 Controller firmware can be updated by using one of the communication interfaces described in [Chap. 8.7 - Communication interfaces](#).

In particular:

- for RS485 serial connection (in the models where available), refer to the protocol document available at the following link: <https://www.ducatienergia.com/product.php?lang=en&id=8&cat=13&product=89>
- for 868Mhz Radio interface (in the models where available), refer to the documents of Ducati Energia Energy Bridge device, available at the following link: www.ducatienergia.com
- for NFC interface, use an Android-compatible device and download the Ducati Smart Energy App by framing the QR-code:



GO BACK TO [USING THE CONTROLLER](#)

GO BACK TO [CONTENTS](#)

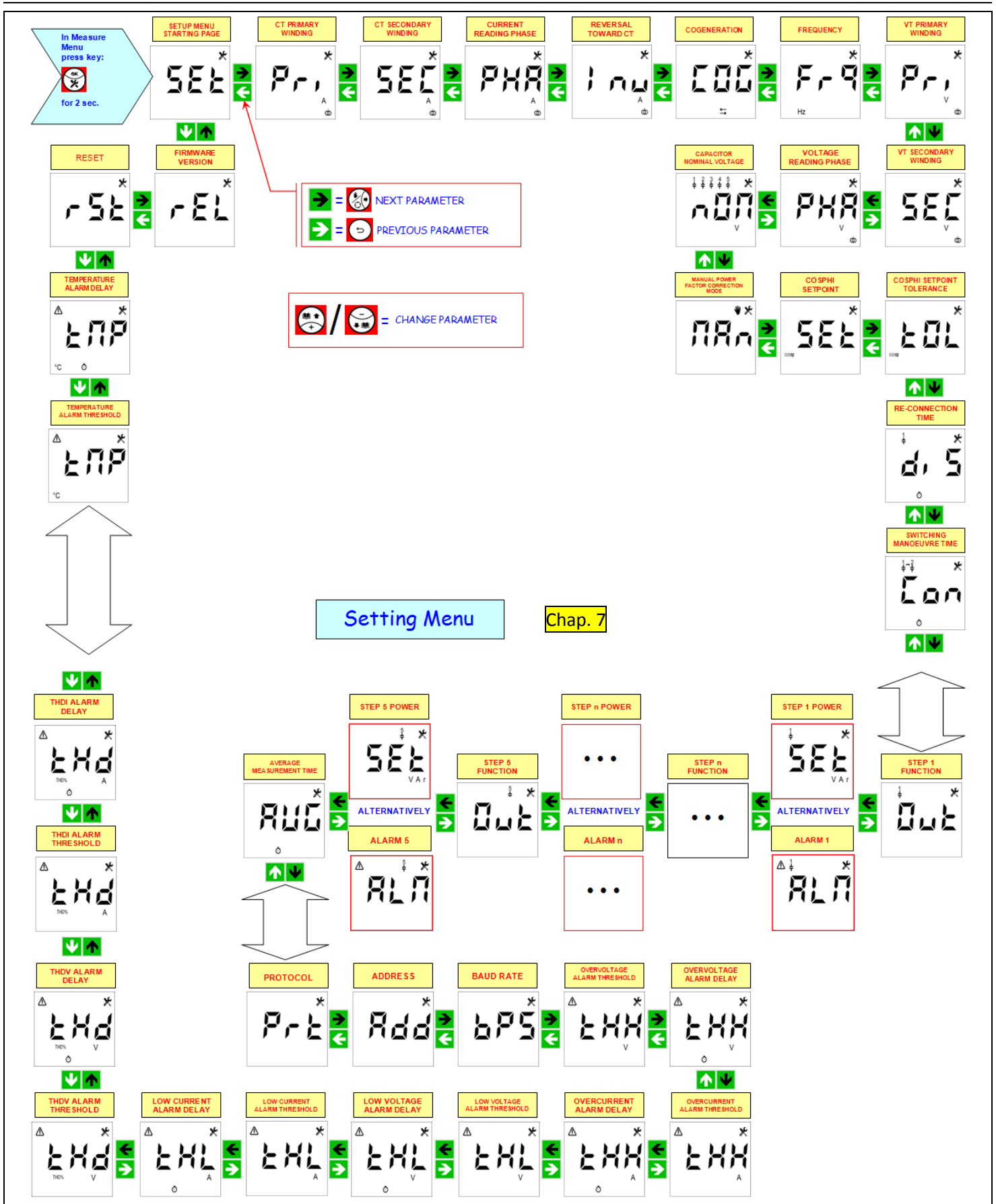



In Measure Menu
press key: & for 10 sec.

MANOEUVRE TIME DIFFERENTIATION P. 1	DISCONNECTION MANOEUVRE TIME P. 2	EVALUATION TIME P. 3	TRANSIENT TIME DURING DISCONNECTION P. 4	TRANSIENT TIME DURING INSERTION P. 5	MEASUREMENT STABILITY CHECK P. 6	STABILITY CHECK THRESHOLD P. 7	PRESENCE OF BLOCKING REACTOR P. 8
ALARM MASKING MANAGEMENT P. 25	<p> = NEXT PARAMETER</p> <p> = PREVIOUS PARAMETER</p> <p> = / CHANGE PARAMETER</p>					DEGRADATION THRESHOLD 1 P. 9	
THDI INVALIDATION THRESHOLD P. 24	POWER FACTOR CORRECTION DELAY P. 23	Advanced Setting Menu			Chap. 7.6		
STEP MAXIMUM CONNECTION TIME P. 21	POWER FACTOR OVERCORRECTION ALARM DELAY P. 22					FAULT THRESHOLD 1 P. 10	
MICRO INTERRUPTION DURATION P. 20	TYPE OF NETWORK P. 19	988MHz: RADIO POWER P. 18	988MHz: RADIO CHANNEL P. 17	988MHz: RADIO ADDRESS P. 16	POWER THRESHOLD FOR AUTO-ACQUISITION P. 15	DISPLAY OF VALUES FROM HARMONIC ANALYSIS P. 14	CURRENT ALARM RESET P. 13
							FAULT THRESHOLD 2 P. 12

Start Up or
press key: for 2 sec.

COSPHI 0.97	REACTIVE POWER 35.8 K V A r	CURRENT 200 A	VOLTAGE 400 V	FREQUENCY 50.0 Hz	ACTIVE POWER 134 K W
TEMPERATURE 30.3 °C	POWER FACTOR PF 0.97	THDV% 12 V	THDI% 0.9 A	APPARENT POWER 139 K V A	

= NEXT PARAMETER
 = PREVIOUS PARAMETER

Chap. 8.3

Measurement Menu

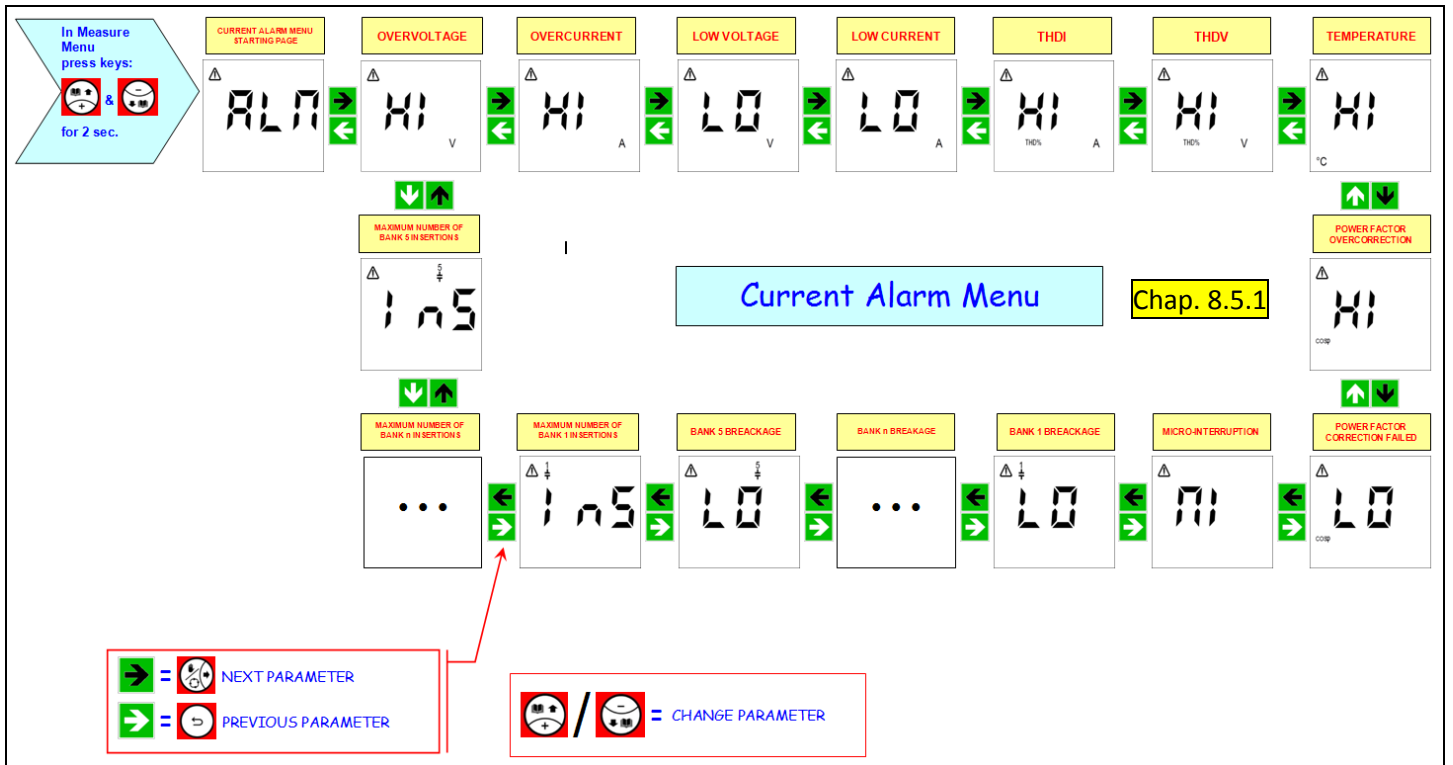
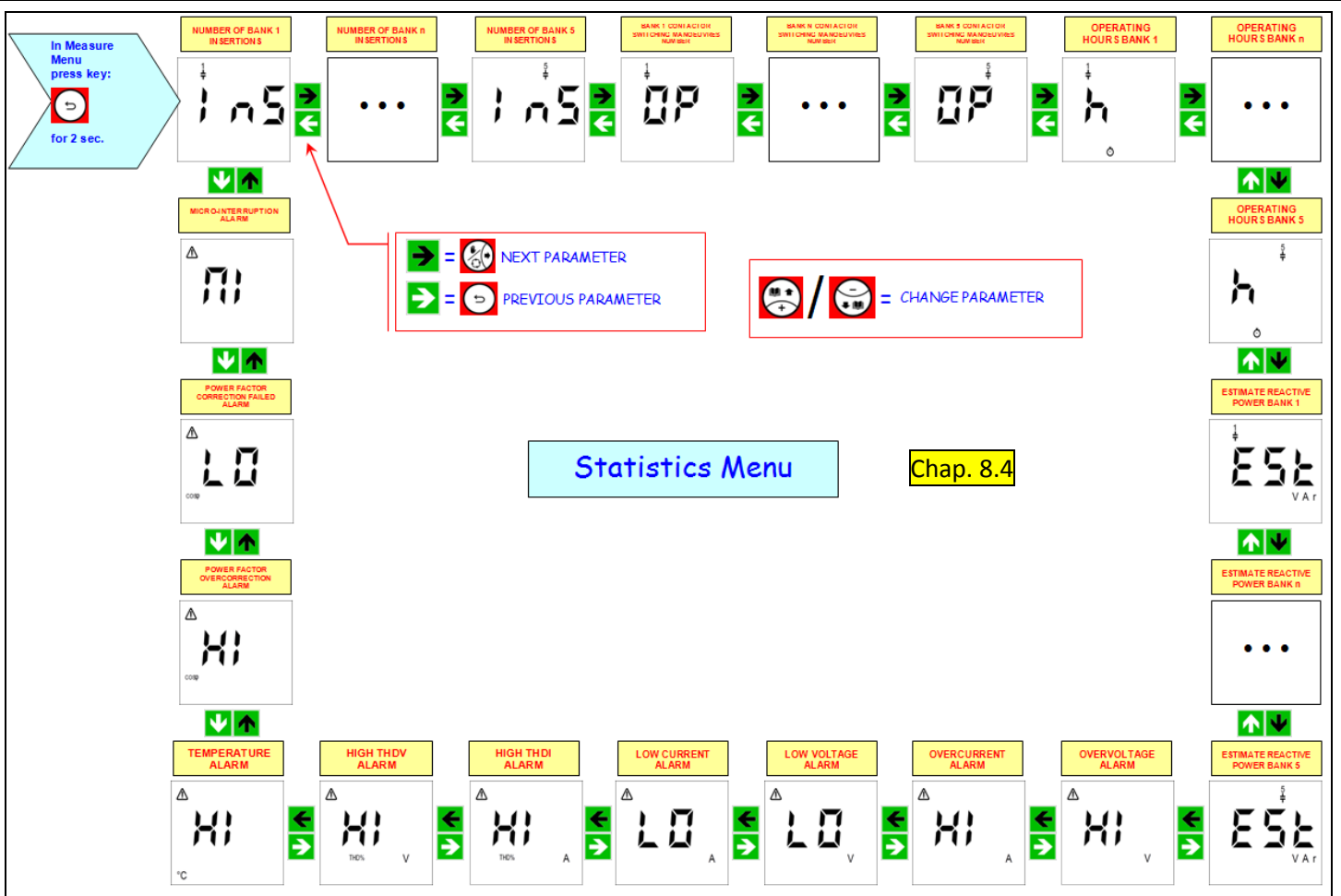



Enter in Edit mode by pressing keys or in Setup Menu Reset Page

BANK N PARAMETER/ STATISTIC #1 C1*	BANK N CONTACTOR SWITCHING MANOEUVRES NUMBER 1 OP1*	BANK N PARAMETER/ STATISTIC #2 C2*	BANK N CONTACTOR SWITCHING MANOEUVRES NUMBER 2 OP2*	BANK N PARAMETER/ STATISTIC #3 C3*	BANK N CONTACTOR SWITCHING MANOEUVRES NUMBER 3 OP3*	BANK N PARAMETER/ STATISTIC #4 C4*	BANK N CONTACTOR SWITCHING MANOEUVRES NUMBER 4 OP4*
FACTORY SETTINGS ALL*	AUTO-ACQUISITION ACQ*	MINIMUM END MAXIMUM VALUE PEA*	AVERAGE VALUE AUC*	ALARMS ALA*	BANK N CONTACTOR SWITCHING MANOEUVRES NUMBER 5 OPS*	BANK N PARAMETER/ STATISTIC #5 C5*	

= NEXT PARAMETER
 = PREVIOUS PARAMETER
 = CHANGE PARAMETER

Reset Menu Chap. 8.6

[GO BACK TO CONTENTS](#)