FOR SMOOTH MOTOR CONTROL AND ENERGY SAVINGS

Low voltage AC drives and softstarters

Catalog and price list



—

**AC drives and
softstarters.
For smooth
motor control
and energy
savings.**

Table of contents

04–05	Smooth motor control and energy savings
06	Choosing the right drive for your application
06–07	ABB AC drive selection table
08–14	ABB general purpose drives ACS480, ACS580
16–21	ABB micro drives ACS55, ACS150
22–24	ABB machinery drives ACS355
25–27	ABB general purpose drives ACS310
28–39	Options
40	ABB softstarters How we are helping the industry
41	ABB softstarters selection tool
42–47	ABB softstarters
48–51	Accessories
52–53	Introducing the most extensive drives and softstarters portfolio in the world
54–55	We keep your world turning
56	A lifetime of peak performance

Smooth motor control and energy savings

What is an AC drive?

An AC drive is an electronic device that is used to adjust the rotating speed and torque of a standard, electric AC motor. The electric motor, in turn, drives a load such as a fan, pump or conveyor.

AC drives are also referred to as frequency converters, variable frequency drives (VFD), variable speed drives (VSD), adjustable frequency drives (AFD), adjustable speed drives (ASD) or inverters.

What is a softstarter?

Softstarter is a full-speed starter that accelerates, decelerates and protects three phase motors. The softstarter controls the voltage

applied to the motor by using thyristors which gives it control over current, torque and acceleration. The softstarter's parameters can be configured to match the application's requirements, so that the required current and torque are optimized.

ABB - global market and technology leader in AC drives

ABB (www.abb.com) is a leader in power and automation technologies that enable utility and industry customers to improve their performance while lowering environmental impact. ABB is the world's largest drives manufacturer. ABB operates in more than 100 countries with about 110,000 employees.

Electric motors consume about 65% of all electricity used throughout industry. Yet, less than 10% of those motors are fitted with a variable speed drive or a softstarter.

Softstarters are ideal choice when an application requires speed and torque control only during startup. The softstarters prevent large inrush currents from being drawn while starting the motor by smoothly ramping up the supply voltage. The smooth ramp up prolongs the life

time of the motors because less current means also less heat in the motors. AC drives, on the other hand, are good choice when speed control only during a startup is not enough, big energy savings are a must, custom motor control is required, or more functionalities are needed.



Choosing the right drive for your application

Step	Process	Action
1	Identify the application Identify the type of application and the likely demands of the drive.	Continue to step 2.
2	Gather the load data: system inertia, required acceleration and deceleration rates, minimum and maximum speeds, overload requirements, etc. This information can often be determined by the performance of the existing motor.	Continue to step 3.
3	Gather the motor data: rated torque, kW, volts, insulation class, speed, etc. Whether an existing motor or a new motor is being used, the motor information is critical to choosing a drive.	Continue to step 4.
4	Choose a drive Match the data gathered in Steps 1 to 3 against the table of drive features on page 5. Select a drive that meets the motor requirements and has all the software features needed for the application.	Continue to step 5.
5	Is the drive offered in the correct kW/amp rating? The drive you choose must be able to supply the necessary current to the motor to produce the torque required. This includes normal and overload conditions. Select current from the tables on pages 10, 13, 16, 19, 22 or 25 depending on drive type selected.	If yes, continue to step 6. If no, go to step 4.
6	Is the drive offered in the correct enclosure and environmental ratings? The drive you choose must be available in an enclosure style that will withstand the application's environment. It also must produce the required current at the application's altitude and ambient temperature.	If yes, continue to step 7. If no, go to step 4.
7	Does this drive have the features needed to meet the application's demands? The drive you choose must have a feature set that matches the application. It also must have sufficient hardware (inputs and outputs, feedback, communications, etc.) to perform the application.	If yes, continue to step 8. If no, go to step 4.
8	Does this drive have the motor control performance to meet the application's demands? The drive you choose must be able to produce the needed torque at the necessary speeds. It must also be able to control speed and torque depending on the application requirements.	If yes, continue to step 9. If no, go to step 4.
9	Congratulations! The ABB AC drive you have chosen has the features and performance needed for a successful application.	

ABB AC drive selection table

Applications where to use	ABB micro drives		ABB machinery drive	ABB general purpose drives		
	ACS55	ACS150	ACS355	ACS310	ACS480	ACS580
Pumps	●	●	●	●	●	●
Fans	●	●	●	●	●	●
Conveyors	●	●	●	–	●	●
Material handling machines	●	●	●	–	●	●
Exercise equipment	●	●	–	–	–	–
White goods	●	●	–	–	–	–
Gates, doors, barriers	●	●	●	–	●	–
Compressors	–	–	●	●	●	●
Cutting machines, shears, saws	–	–	●	–	●	●
Extruders	–	–	●	–	●	●
Machine tools, mixers, stirrers	–	–	●	–	●	●
Spinning machines	–	●	●	–	●	●
Centrifuges	–	–	●	–	●	●
Processing lines	–	–	–	–	●	●

Specification		ACS55	ACS150	ACS355	ACS310	ACS480	ACS580
Voltage and power ranges		1-phase, 100 to 120 V: 0.18 to 0.37 kW	1-phase, 200 to 240 V: 0.37 to 2.2 kW	1-phase, 200 to 240 V: 0.37 to 2.2 kW	1-phase, 200 to 240 V: 0.37 to 2.2 kW		
		1-phase, 200 to 240 V: 0.18 to 2.2 kW	3-phase, 200 to 240 V: 0.37 to 2.2 kW	3-phase, 200 to 240 V: 0.37 to 11 kW	3-phase, 200 to 240 V: 0.37 to 11 kW		3-phase, 200 to 240 V: 0.75 to 75 kW
			3-phase, 380 to 480 V: 0.37 to 4 kW	3-phase, 380 to 480 V: 0.37 to 22 kW	3-phase, 380 to 480 V: 0.37 to 22 kW	3-phase, 380 to 480 V: 0.75 to 22 kW	3-phase, 380 to 480 V: 0.75 to 500 kW
Protection classes	IP20	●	●	●	●	●	○
	IP21	–	–	○	○	–	●
	IP54/IP55	–	–	–	–	–	● ¹⁾
	IP66/IP67	–	–	● ¹⁾	–	–	–
Mounting arrangements	Optimal for cabinet mounting	●	●	●	●	●	●
	Optimal for wall mounting	–	–	● (IP66/67 variant)	–	–	●
Programming	Parameter programming	●	●	●	●	●	●
	Sequence programming	–	–	●	–	●	●
Human-machine interface	Basic control panel	–	●	●	●	○	○
	Assistant control panel	–	–	○/● (with IP66/67 variant)	○	●	●
	Assistant control panel with bluetooth link	–	–	–	–	○	○
Ambient temperature	0 to +40 °C with nominal current and 5 kHz switching frequency, up to +50 °C with derating, -20 °C with restrictions.	-10 to +40 °C, no frost allowed, +50 °C with 10% derating.	-10 to +40 °C, no frost allowed, +50 °C with 10% derating.	-10 to +50 °C (14 to 122 °F), no frost allowed.	-10 to +50 °C (14 to 122 °F), no frost allowed. From +50 to +60 °C with derating.	-15 to +40 °C (5 to 104 °F), no frost allowed. From +40 to +50 °C with derating.	
Inputs and outputs	Digital inputs/outputs	3/0	5/0	5/1	5/1	6/0	6/0
	Relay outputs	1	1	1	1	3 + (6 as option)	3 + (2 as option)
	Analog inputs/outputs	1/0	2/1	2/1	2/1	2/2	2/2
	Speed feedback	–	–	○	–	–	–
Supported fieldbus protocols	Modbus RTU	–	–	○	●	●	●
	Profibus DP	–	–	○	–	○	○
	DeviceNet™	–	–	○	–	○	○
	ControlNet	–	–	○	–	○	○
	CANopen®	–	–	○	–	○	○
	Ethernet (Modbus/TCP)	–	–	○	–	○	○
	Ethernet (EtherNet/IP™)	–	–	○	–	○	○
	Ethernet (EtherCAT®)	–	–	○	–	○	○
	Ethernet (PROFINET IO)	–	–	○	–	○	○
	Ethernet (POWERLINK)	–	–	○	–	○	○
EMC compliance (EN 61800-3)	C3, industrial use	●	●	●	●	●	●
	C2, commercial use (installation by EMC experts)	●	○	○	○	●	●
	C1, commercial use	○ (conductive emissions)	○ (conductive emissions)	○ (conductive emissions)	○ (conductive emissions)	○ (conductive emissions)	○ (conductive emissions)
Chokes	Input chokes	○	○	○	○	○	● (built-in)
	Output chokes	○	○	○	○	○	○
Brake chopper	–	●	●	–	●	● ²⁾	
Suggested maximum motor cable length	30 to 50 m	30 to 60 m	30 to 60 m	30 to 60 m	50 to 150 m	100 to 300 m	
Switching frequency	up to 16 kHz	up to 16 kHz	up to 16 kHz	up to 16 kHz	up to 12 kHz	up to 12 kHz	
Output frequency	0 to 120/130 Hz	0 to 500 Hz	0 to 599 Hz	0 to 599 Hz	0 to 500 Hz	0 to 500 Hz	
Overload capacity	150% for 60 s	150% for 60 s, 180% for 2 s	150% for 60 s, 180% for 2 s	110% for 60 s, 180% for 2 s	150% for 60 s, 180% for 2 s	150% for 60 s, 180% for 2 s ³⁾	
Number of preset speeds	1	3	7	7	7	7	
PC tools	Drive commissioning tool	○	–	○	○	○	○
	Drive offline programming tool	–	○	○	○	○	○
	Drive dimensioning tool	–	–	–	–	–	○
Approvals	CE, UL, cUL, C-Tick, EAC	●	●	●	●	●	●
RoHS compliance		●	●	●	●	●	●

● = Standard
○ = Option
– = Not available

¹⁾ IP66/67 and IP54/55 product variants

²⁾ Up to R3 as standard

³⁾ ACS580-01-293A-4 130% for 60 s, ACS580-01-430A-4 125% for 60 s and ACS580-04-880A-4 140% for 60 s.

ABB general purpose drives

ACS480, 0.75 to 22 kW

—
01
ACS480 frame sizes:
R1, R2, R3, R4

What is it?

The ACS480 is ready made package having all essential features built-in as standard, simplifying drive selection, and making additional hardware unnecessary. Straightforward settings menu and assistants enable fast setup, commissioning, use and maintenance.

With its cabinet optimized size and embedded features, ACS480 is a great fit for variable torque and basic speed applications, where easiness, reliability and efficiency matters. However, if more power or options are needed, ACS580 is a great choice.



—
01

Feature	Advantage	Benefit
Control panel and Primary settings menu with multi-language support	Effortless commissioning, configuration, monitoring and defect tracking. No need to know parameters with the Primary settings menu.	Substantial time savings. Drive speaks your local language. No need for manual as the help function is already built-in to the panel.
Optimized for cabinet installations with unified height and depth.	Highest power density against most of the comparable products in the market. Multiple drives can be installed side-by-side.	Cost, space and time savings
All essentials built-in	Integrated C2 EMC filter, Safe torque off, brake chopper and Modbus RTU are built-in to simplify selection, ordering and installation	Reduces amount of external components and manual work. Standard drive available from central stock with simplified logistics and without need for extra configuration.
Energy efficiency functionality	Support for high efficiency motors enables best system efficiency. Built-in energy optimizer ensures maximum torque per ampere. And energy efficiency information help you monitor and save the energy used in your process.	Energy savings through improved energy management
Standard safety functions	Integrated, certified safety with SIL3/PL e safe torque off (STO), fulfilling the machinery directive.	Fulfills Machinery Directive 2006/42/EC, EN/ IEC 61800-5-2:2007. Cost-effective and certified solution for safe machine maintenance.

Inputs and outputs

The figure shows the ACS480 factory-set standard inputs and outputs. All inputs and outputs are freely programmable.

The base unit includes:

- 2 digital inputs
- 1 relay output
- Safe torque off (SIL3/PL e)

The rest of the connections comes with the I/O module (RIIO-01):

- 2 analog inputs
- 2 analog outputs
- 4 digital inputs
- 2 relay outputs

The standard delivery includes an I/O module. If a fieldbus adapter is needed, it is delivered instead of the I/O module. If the I/Os on the base unit are not enough when using a fieldbus adapter, an optional I/O extension (BIO-01) can be used underneath a fieldbus adapter.

Terminal	Meaning	Terminal Meaning	Default macro connections
Reference voltage and analog inputs and outputs			
1	SCR	Signal cable shield (screen)	
2	AI1	Output frequency/speed reference: 0...10 V³⁾	
3	AGND	Analog input circuit common	
4	+10 V	Reference voltage 10 V DC	
5	AI2	Not configured	
6	AGND	Analog input circuit common	
7	AO1	Output frequency: 0...20 mA	
8	AO2	Output current: 0...20 mA	
9	AGND	Analog output circuit common	
Aux. voltage output and programmable digital inputs			
10	+24 V	Auxiliary voltage output +24 V DC, max. 200 mA	
11	DGND	Auxiliary voltage output common	
12	DCOM	Digital input common for all	
13	DI1	Stop (0)/Start (1)	
14	DI2	Forward (0)/Reverse (1)	
15	DI3	Constant frequency/speed selection	
16	DI4	Constant frequency/speed selection	
17	DI5	Ramp set 1 (0)/Ramp set 2 (1)	
18	DI6	Not configured	
Relay outputs			
19	RO1C	Ready 250 V AC/30 V DC 2 A	
20	RO1A		
21	RO1B	Running 250 V AC/30 V DC 2 A	
22	RO2C		
23	RO2A	Fault (-1) 250 V AC/30 V DC 2 A	
24	RO2B		
25	RO3C		
26	RO3A		
27	RO3B		
EIA-485 Modbus RTU			
29	B+	Embedded Modbus RTU (EIA-485)	
30	A-		
31	DGND		
S100	TERM&BIAS	Serial data link termination switch	
Safe torque off			
34	SGND	Safe torque off. Factory connection. Both circuits must be closed for the drive to start. See chapter The Safe torque off function in the Hardware manual of the drive.	
35	IN1		
36	IN2		
37	OUT1		
42	+24 V		
43	DGND		
44	DCOM		

Dimensions and weights

Frame size	H (mm)	W (mm)	D (mm)	Weight (kg)
R1	223.0	73.0	207.1	1.77
R2	223.0	96.6	207.1	2.35
R3	220.0	171.7	207.1	3.52
R4	240.0	260.0	212.1	6.02



Types and voltages

Light-duty use		Heavy-duty use		ABB ordering code Enclosure IP20	Electrical code/ reference code	ABB type code/ order code for IP20	Frame size	Price (Eur)
P_{Ld} (kW)	I_{Ld} (A)	P_{Hd} (kW)	I_{Hd} (A)					
3-phase, $U_N = 400$ V (3-phase supply AC voltage range 380-480 V)								
0.75	2.5	0.55	1.8	3AXD50000047765		ACS480-04-02A7-4	R1	
1.1	3.1	0.75	2.6	3AXD50000047766		ACS480-04-03A4-4	R1	
1.5	3.8	1.1	3.3	3AXD50000047767		ACS480-04-04A1-4	R1	
2.2	5.3	1.5	4	3AXD50000047768		ACS480-04-05A7-4	R1	
3	6.8	2.2	5.6	3AXD50000047769		ACS480-04-07A3-4	R1	
4	8.9	3	7.2	3AXD50000047770		ACS480-04-09A5-4	R1	
5.5	12	4	9.4	3AXD50000047791		ACS480-04-12A7-4	R2	
7.5	16.2	5.5	12.6	3AXD50000047792		ACS480-04-018A-4	R3	
11	23.8	7.5	17	3AXD50000047793		ACS480-04-026A-4	R3	
15	30.5	11	25	3AXD50000199068		ACS480-04-033A-4	R4	
18.5	36	15	32	3AXD50000199075		ACS480-04-039A-4	R4	
22	42.8	18.5	38	3AXD50000199082		ACS480-04-046A-4	R4	
22	48	22	45	3AXD50000199099		ACS480-04-050A-4	R4	

Light-duty use

P_{Ld}	Typical motor power in light-duty use.
I_{Ld}	Continuous current allowing 110% I_{Ld} for 1 min/10 min at 50 °C

Heavy-duty use ratings

P_{Hd}	Typical motor power in heavy-duty use
I_{Hd}	Continuous current allowing 150% I_{Hd} for 1 min/10 min at 50 °C

For more technical information, see ACS480 catalog (3AUA0000145061 EN)

ABB general purpose drives

ACS580, 0.75 to 500 kW

—
01
ACS580 frame sizes:
R1 to R11



What is it?

The ACS580 is plug-in ready to control your compressors, conveyors, pumps, mixers, fans and many other variable and constant torque applications. Most essential features are built-in as standard, simplifying drive selection, and making additional hardware unnecessary. Straightforward settings menu and assistants enable fast setup, commissioning, use and maintenance.

The ACS580 drive meets the requirements of drive users, installers, electricians, machine builders, system integrators and panel builders.

Feature	Advantage	Benefit
Control panel and Primary settings menu with multi-language support	Effortless commissioning, configuration, monitoring and defect tracking. No need to know parameters with the Primary settings menu.	Substantial time savings. Drive speaks your local language. No need for manual as the help function is already built-in to the panel.
Installation and commissioning	Highest power density against most of the comparable products in the market. Multiple drives can be installed side-by-side.	Cost, space and time savings
Connect to public low voltage networks	Integrated C2 EMC filter (1 st environment) for frame sizes R1 to R9 or C3 EMC filter (2 nd environment) for frame sizes R10 to R11 and swinging choke (compatible harmonics levels) as standard	Ensure that the product can be used on public installations and therefore no additional filters or engineering is required.
Energy efficiency functionality	The built-in energy efficiency calculators monitoring used and saved kWh, CO ₂ reduction and money saved. The energy optimizer ensures the maximum torque per ampere. The wall-mounted drive fulfills the highest IE2 drive (EN 50598-2) energy efficiency class and is compatible with high-efficiency IE4 motors.	Energy savings through improved energy management
Standard safety functions	Integrated, certified safety with SIL3/PL e safe torque off (STO), fulfilling the machinery directive.	Fulfills Machinery Directive 2006/42/EC, EN/IEC 61800-5-2:2007. Cost-effective and certified solution for safe machine maintenance.

Inputs and outputs

The figure shows the ACS580 factory-set standard inputs and outputs. All inputs and outputs are freely programmable.

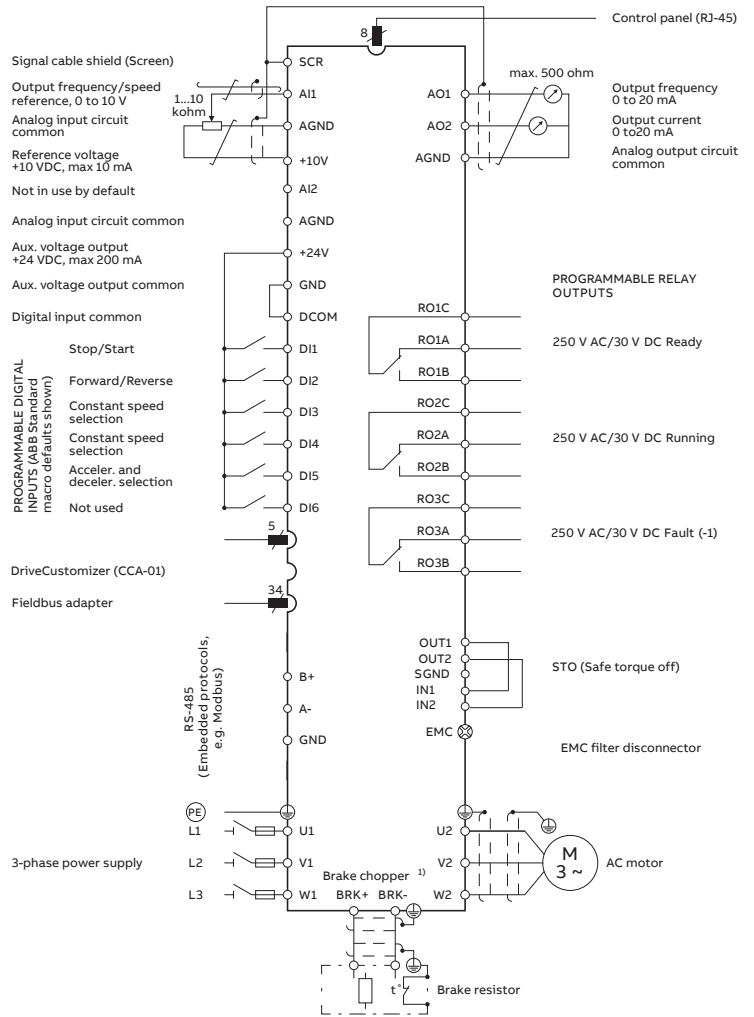

Dimensions and weights

Wall mounted frames IP21				
Frame size	H ^{*)} (mm)	W (mm)	D (mm)	Weight (kg)
R1	373	125	223	4.6
R2	473	125	229	7.5
R3	490	203	229	13.8
R4	636	203	257	19.0
R5	732	203	295	28.5
R6	727	252	369	45
R7	880	284	370	54
R8	965	300	393	69
R9	955	380	418	97

^{*)} Front height of the drive with glandbox

Wall mounted frames IP55				
Frame size	H ^{*)} (mm)	W (mm)	D (mm)	Weight (kg)
R1	403	128	232	5.1
R2	503	128	239	6.7
R3	490	206	237	13.0
R4	636	206	265	20
R5	732	203	320	29
R6	727	252	380	43
R7	880	284	381	56
R8	965	300	452	77
R9	955	381	477	103

^{*)} Front height of the drive with glandbox

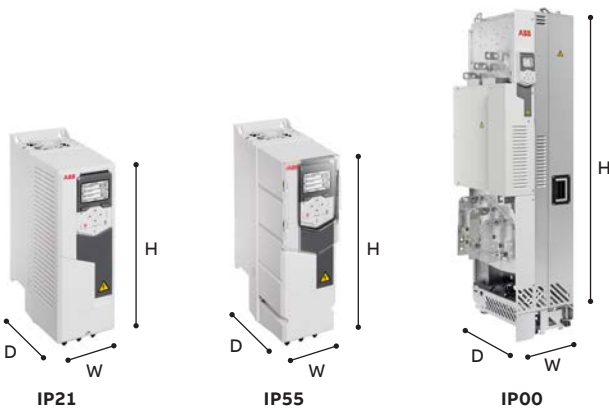

Drive modules				
Frame size	IP00/UL open type			
	H (mm)	W (mm)	D (mm)	Weight (kg)
R10	1462	350	529	162
R11	1662	350	529	200

Types and voltages

Light-duty applications		Heavy-duty applications		ABB ordering code Enclosure IP21	Electrical code/ reference code	ABB type code/order code for IP21 units	Frame size	Price for IP21 units (Eur)
P_{motor} (kW)	I_{motor} (A)	P_{motor} (kW)	I_{motor} (A)					
3-phase, $U_N = 400$ V (3-phase supply AC voltage range 380-480 V)								
0.75	2.5	0.55	1.8	3AXD50000038937		ACS580-01-02A7-4	R1	
1.1	3.1	0.75	2.6	3AXD50000038938		ACS580-01-03A4-4	R1	
1.5	3.8	1.1	3.3	3AXD50000038939		ACS580-01-04A1-4	R1	
2.2	5.3	1.5	4	3AXD50000038940		ACS580-01-05A7-4	R1	
3	6.8	2.2	5.6	3AXD50000038951		ACS580-01-07A3-4	R1	
4	8.9	3	7.2	3AXD50000038952		ACS580-01-09A5-4	R1	
5.5	12	4	9.4	3AXD50000038953		ACS580-01-12A7-4	R1	
7.5	16.2	5.5	12.6	3AXD50000038959		ACS580-01-018A-4	R2	
11	23.8	7.5	17	3AXD50000038960		ACS580-01-026A-4	R2	
15	30.4	11	24.6	3AXD50000038961		ACS580-01-033A-4	R3	
18.5	36.1	15	31.6	3AXD50000038962		ACS580-01-039A-4	R3	
22	42.8	18.5	37.7	3AXD50000038963		ACS580-01-046A-4	R3	
30	58	22	44.6	3AUA0000080498		ACS580-01-062A-4	R4	
37	68.4	30	61	3AUA0000080499		ACS580-01-073A-4	R4	
45	83	37	72	3AUA0000080502		ACS580-01-088A-4	R5	
55	100	45	87	3AUA0000080503		ACS580-01-106A-4	R5	
75	138	55	105	3AUA0000080504		ACS580-01-145A-4	R6	
90	161	75	145	3AUA0000080505		ACS580-01-169A-4	R7	
110	196	90	169	3AUA0000080506		ACS580-01-206A-4	R7	
132	234	110	206	3AUA0000080507		ACS580-01-246A-4	R8	
160	278	132	246 ^{*)}	3AUA0000080508		ACS580-01-293A-4	R8	
200	345	160	293	3AUA0000080509		ACS580-01-363A-4	R9	
250	400	200	363 ^{**)}	3AUA0000080510		ACS580-01-430A-4	R9	

Light-duty applications		Heavy-duty applications		ABB ordering code Enclosure IP55	Electrical code/ reference code	ABB type code/order code for IP55 units	Frame size	Price for IP55 units (Eur)
P_{motor} (kW)	I_{motor} (A)	P_{motor} (kW)	I_{motor} (A)					
3-phase, $U_N = 400$ V (3-phase supply AC voltage range 380-480 V)								
0.75	2.5	0.55	1.8	3AXD50000038964		ACS580-01-02A7-4+B056	R1	
1.1	3.1	0.75	2.6	3AXD50000038965		ACS580-01-03A4-4+B056	R1	
1.5	3.8	1.1	3.3	3AXD50000038966		ACS580-01-04A1-4+B056	R1	
2.2	5.3	1.5	4	3AXD50000038967		ACS580-01-05A7-4+B056	R1	
3	6.8	2.2	5.6	3AXD50000038968		ACS580-01-07A3-4+B056	R1	
4	8.9	3	7.2	3AXD50000038969		ACS580-01-09A5-4+B056	R1	
5.5	12	4	9.4	3AXD50000038970		ACS580-01-12A7-4+B056	R1	
7.5	16.2	5.5	12.6	3AXD50000038976		ACS580-01-018A-4+B056	R2	
11	23.8	7.5	17	3AXD50000038977		ACS580-01-026A-4+B056	R2	
15	30.4	11	24.6	3AXD50000038978		ACS580-01-033A-4+B056	R3	
18.5	36.1	15	31.6	3AXD50000038979		ACS580-01-039A-4+B056	R3	
22	42.8	18.5	37.7	3AXD50000038980		ACS580-01-046A-4+B056	R3	
30	58	22	44.6	3AUA0000083573		ACS580-01-062A-4+B056	R4	
37	68.4	30	61	3AUA0000083574		ACS580-01-073A-4+B056	R4	
45	83	37	72	3AUA0000083577		ACS580-01-088A-4+B056	R5	
55	100	45	87	3AUA0000083578		ACS580-01-106A-4+B056	R5	
75	138	55	105	3AUA0000083579		ACS580-01-145A-4+B056	R6	
90	161	75	145	3AUA0000083580		ACS580-01-169A-4+B056	R7	
110	196	90	169	3AUA0000083581		ACS580-01-206A-4+B056	R7	
132	234	110	206	3AUA0000083582		ACS580-01-246A-4+B056	R8	
160	278	132	246 ^{*)}	3AUA0000083583		ACS580-01-293A-4+B056	R8	
200	345	160	293	3AUA0000083584		ACS580-01-363A-4+B056	R9	
250	400	200	363 ^{**)}	3AUA0000083585		ACS580-01-430A-4+B056	R9	

Light-duty use

P_{Ld}	Typical motor power in light-duty use
I_{Ld}	Continuous current allowing 110% I_{Ld} for 1 minute every 10 minutes at 40 °C

Heavy-duty use ratings

P_{Hd}	Typical motor power in heavy-duty use
I_{Hd}	Continuous current allowing 150% I_{Hd} for 1 min/10 min at 40 °C *) Continuous current allowing 130% I_{Hd} for 1 min/10 min at 40 °C **) Continuous current allowing 125% I_{Hd} for 1 min/10 min at 40 °C

For more technical information, see ACS580 catalog (3AUA0000145061 EN) or ABB drives product guide (3AFE68401771 EN)

Types and voltages

Light-duty applications		Heavy-duty applications		ABB ordering code Enclosure IP00	Electrical code/ reference code	ABB type code/order code for IP00 units	Frame size	Price for IP00 units (Eur)
P_{motor} (kW)	I_{motor} (A)	P_{motor} (kW)	I_{motor} (A)					
3-phase, $U_N = 400$ V (3-phase supply AC voltage range 380-480 V)								
250	485	200	361	3AUA0000184475		ACS580-04-505A-4	R10	
315	575	250	429	3AUA0000184601		ACS580-04-585A-4	R10	
355	634	250	477	3AUA0000184651		ACS580-04-650A-4	R10	
400	715	315	566	3AUA0000184652		ACS580-04-725A-4	R11	
450	810	355	625	3AUA0000184663		ACS580-04-820A-4	R11	
500	865	400	725 ^{*)}	3AUA0000184476		ACS580-04-880A-4	R11	

Light-duty use

P_{Ld}	Typical motor power in light-duty use
I_{Ld}	Continuous current allowing 110% I_{Ld} for 1 minute every 10 minutes at 40 °C

Heavy-duty use ratings

P_{Hd}	Typical motor power in heavy-duty use
I_{Hd}	^{*)} Continuous current allowing 140% I_{Hd} for 1 min/10 min at 40 °C

Light-duty applications		Heavy-duty applications		ABB ordering code Enclosure IP21/IP00	Electrical code/ reference code	ABB type code/order code for IP21/IP00 units	Frame size	Price for IP21/IP00 units (Eur)
P_{motor} (kW)	I_{motor} (A)	P_{motor} (kW)	I_{motor} (A)					
3-phase, $U_N = 230$ V (3-phase supply AC voltage range 200-240 V)								
0.75	4.6	0.6	3.5	3AXD50000417346		ACS580-01-04A7-2	R1	
1.1	6.6	0.8	4.6	3AXD50000417353		ACS580-01-06A7-2	R1	
1.5	7.5	1.1	6.6	3AXD50000417360		ACS580-01-07A6-2	R1	
3.0	11.8	2.2	7.5	3AXD50000417377		ACS580-01-012A-2	R1	
4.0	16.7	3.0	10.6	3AXD50000417384		ACS580-01-018A-2	R1	
5.5	24.2	4.0	16.7	3AXD50000417391		ACS580-01-025A-2	R2	
7.5	30.8	5.5	24.2	3AXD50000417407		ACS580-01-032A-2	R2	
11.0	46.2	7.5	30.8	3AXD50000417414		ACS580-01-047A-2	R3	
15.0	59	11.0	46	3AXD50000417421		ACS580-01-060A-2	R3	
22.0	88	18.5	75	3AXD50000417438		ACS580-01-089A-2	R5	
30	114	22.0	88	3AXD50000417445		ACS580-01-115A-2	R5	
37	143	30.0	114	3AXD50000417452		ACS580-01-144A-2	R6	
45	169	37	143	3AXD50000417469		ACS580-01-171A-2	R7	
55	211	45	169	3AXD50000417476		ACS580-01-213A-2	R7	
75	273	55	211	3AXD50000417483		ACS580-01-276A-2	R8	

Light-duty applications		Heavy-duty applications		ABB ordering code Enclosure IP55	Electrical code/ reference code	ABB type code/order code for IP55 units	Frame size	Price for IP55 units (Eur)
P_{motor} (kW)	I_{motor} (A)	P_{motor} (kW)	I_{motor} (A)					
3-phase, $U_N = 230$ V (3-phase supply AC voltage range 200-240 V)								
0.75	4.6	0.6	3.5	3AXD50000417490		ACS580-01-04A7-2+B056	R1	
1.1	6.6	0.8	4.6	3AXD50000417506		ACS580-01-06A7-2+B056	R1	
1.5	7.5	1.1	6.6	3AXD50000417513		ACS580-01-07A6-2+B056	R1	
3.0	11.8	2.2	7.5	3AXD50000417520		ACS580-01-012A-2+B056	R1	
4.0	16.7	3.0	10.6	3AXD50000417537		ACS580-01-018A-2+B056	R1	
5.5	24.2	4.0	16.7	3AXD50000417544		ACS580-01-025A-2+B056	R2	
7.5	30.8	5.5	24.2	3AXD50000417551		ACS580-01-032A-2+B056	R2	
11.0	46.2	7.5	30.8	3AXD50000417568		ACS580-01-047A-2+B056	R3	
15.0	59	11.0	46	3AXD50000417575		ACS580-01-060A-2+B056	R3	
22.0	88	18.5	75	3AXD50000417582		ACS580-01-089A-2+B056	R5	
30	114	22.0	88	3AXD50000417599		ACS580-01-115A-2+B056	R5	
37	143	30.0	114	3AXD50000417605		ACS580-01-144A-2+B056	R6	
45	169	37	143	3AXD50000417612		ACS580-01-171A-2+B056	R7	
55	211	45	169	3AXD50000417629		ACS580-01-213A-2+B056	R7	
75	273	55	211	3AXD50000417636		ACS580-01-276A-2+B056	R8	

Light-duty use

P_{Ld}	Typical motor power in light-duty use
I_{Ld}	Continuous current allowing 110% I_{Ld} for 1 minute every 10 minutes at 40 °C

Heavy-duty use ratings

P_{Hd}	Typical motor power in heavy-duty use
I_{Hd}	Continuous current allowing 150% I_{Hd} for 1 min/10 min at 40 °C

For more technical information, see ACS580 catalog (3AUA0000145061 EN) or ABB drives product guide (3AFE68401771 EN)



ABB micro drives

ACS55, 0.18 to 2.2 kW

—
01
ACS55 frame
sizes: A, B, C, D

What is it?

The ACS55 drive is a component that can be integrated easily into existing panels, replacing contactors and motor starters. Its compact size is ideal for new installations or whenever speed control of AC induction motors is needed. For users new to drives, its interface with DIP switches and trimmers is exceptionally intuitive.

The ACS55 drive meets the requirements of new drive users, installers, machine builders and panel builders.



—
01

Feature	Advantage	Benefit
Single phase supply	Suitable for single phase residential and commercial applications	Avoids cabling and installation costs associated with three-phase supplies
Slim design	Fits easily into a variety of cabinet designs	Cabinet size can be smaller or greater packing density can be achieved
Flexible installation alternatives	Screw or DIN rail mounting, sideways or side-by-side	One drive type can be used in various designs, saving installation costs and time
High switching frequency	Reduced motor noise	Does not disturb occupants of buildings
Integrated EMC filter as standard	High electromagnetic compatibility	Low EMC emissions in all environments
Easy configuration	Quick setup with DIP switches and trimmers	Substantial time savings. Minimal expertise needed.
DriveConfig kit PC tool	DriveConfig kit PC tool is used to set drive parameters and to upload the parameter set to a drive in seconds, even without a power connection to the drive. The DIP switches and trimmers on the front panel of the drive are disabled after using the DriveConfig kit. This prevents the end users from altering the drive configuration.	Time savings with multiple drives. Drive configuration protected from end user alterations.

Inputs and outputs

The figure shows the ACS55 factory-set standard inputs and outputs.

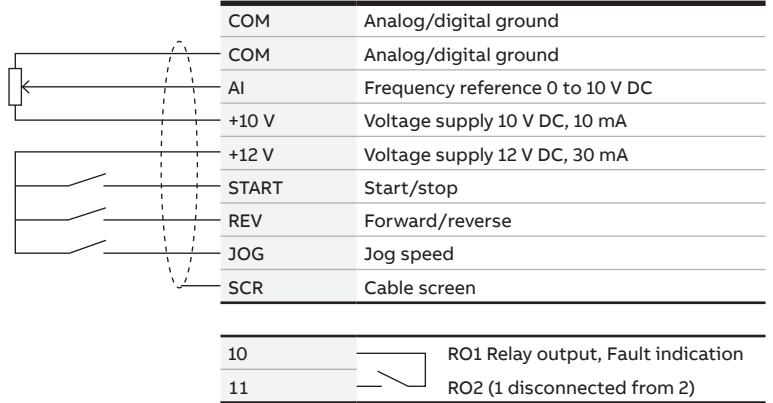

Dimensions and weights

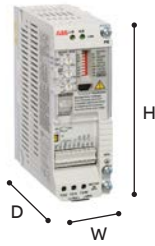

Frame size	Built-in EMC filter				No EMC filter			
	H (mm)	W (mm)	D (mm)	Weight (kg)	H (mm)	W (mm)	D (mm)	Weight (kg)
A	170	45	128	0.65	170	45	128	0.65
B	170	67.5	128	0.9	170	67.5	128	0.9
C	-	-	-	-	194	70	159	1.2
D	226	70	159	1.6	-	-	-	-

Types and voltages

Rated values ^{*)}		ABB ordering code Enclosure IP20	Electrical code/ reference code	ABB type code/ order code	Frame size	Price (Eur)
P_{motor} (kW)	I_{motor} (A)					
Built-in EMC filter, 1-phase AC supply, 200 to 240 V, +10/-15%, 3-phase output 200 to 240 V						
0.18	1.4	68878331		ACS55-01E-01A4-2	A	
0.37	2.2	68878349		ACS55-01E-02A2-2	A	
0.75	4.3	68878357		ACS55-01E-04A3-2	B	
1.5	7.6	68878365		ACS55-01E-07A6-2	D	
2.2	9.8	68878373		ACS55-01E-09A8-2	D	
No EMC filter, 1-phase AC supply, 200 to 240 V, +10/-15%, 3-phase output 200 to 240 V						
0.18	1.4	68878403		ACS55-01N-01A4-2	A	
0.37	2.2	68878420		ACS55-01N-02A2-2	A	
0.75	4.3	68878438		ACS55-01N-04A3-2	B	
1.5	7.6	68878446		ACS55-01N-07A6-2	C	
2.2	9.8	68878454		ACS55-01N-09A8-2	C	
Built-in EMC filter, 1-phase AC supply, 110/120 V, +10/-15%, 3-phase output 200/240 V						
0.18	1.4	68878314		ACS55-01E-01A4-1	A	
0.37	2.2	68878322		ACS55-01E-02A2-1	A	
No EMC filter, 1-phase AC supply, 110/120 V, +10/-15%, 3-phase output 200/240 V						
0.18	1.4	68878381		ACS55-01N-01A4-1	A	
0.37	2.2	68878390		ACS55-01N-02A2-1	A	

^{*)} The rated power and current values are valid for both pump and fan applications and heavy load applications.
Examples of typical heavy load applications include most extruders and compressors.

For more technical information, see ACS55 catalog (3AFE68899842 EN) or ABB product guide (3AFE68401771 EN)

ABB micro drives

ACS150, 0.37 to 4 kW

—
01
ACS150 frame
sizes: R0, R1, R2

What is it?

The ACS150 drive is a component that is brought together with other components and includes, as standard, all necessary functions and interfaces for typical applications with AC induction motors. This makes the product selection very easy.

The ACS150 drive meets the requirements of new drive users, installers, machine builders and panel builders.



—
01

Feature	Advantage	Benefit
User-friendly LCD control panel	Clear alphanumeric display Easy setup and use	Time savings
Flexible mounting alternatives	Screw or DIN rail mounting, sideways or side-by-side	One drive type can be used in various designs, saving installation costs and time
Integrated EMC filter	High electromagnetic compatibility	Low EMC emissions in selected environments
Built-in brake chopper as standard	No need for an external brake chopper	Space savings, reduced installation cost
Embedded potentiometer	Easy to adjust output frequency	Time savings
PID control	Simple integration to process control	Cost savings as a result of less cabling
FlashDrop tool	FlashDrop is a hand held tool that is used to quickly and easily set drive parameters. FlashDrop tool uploads drive parameters directly to unpowered drives. The tool can copy parameters from one drive to another or between a PC and a drive.	Time savings, especially with multiple drives

Inputs and outputs

The figure shows the ACS150 factory-set standard inputs and outputs. All inputs and outputs are freely programmable.

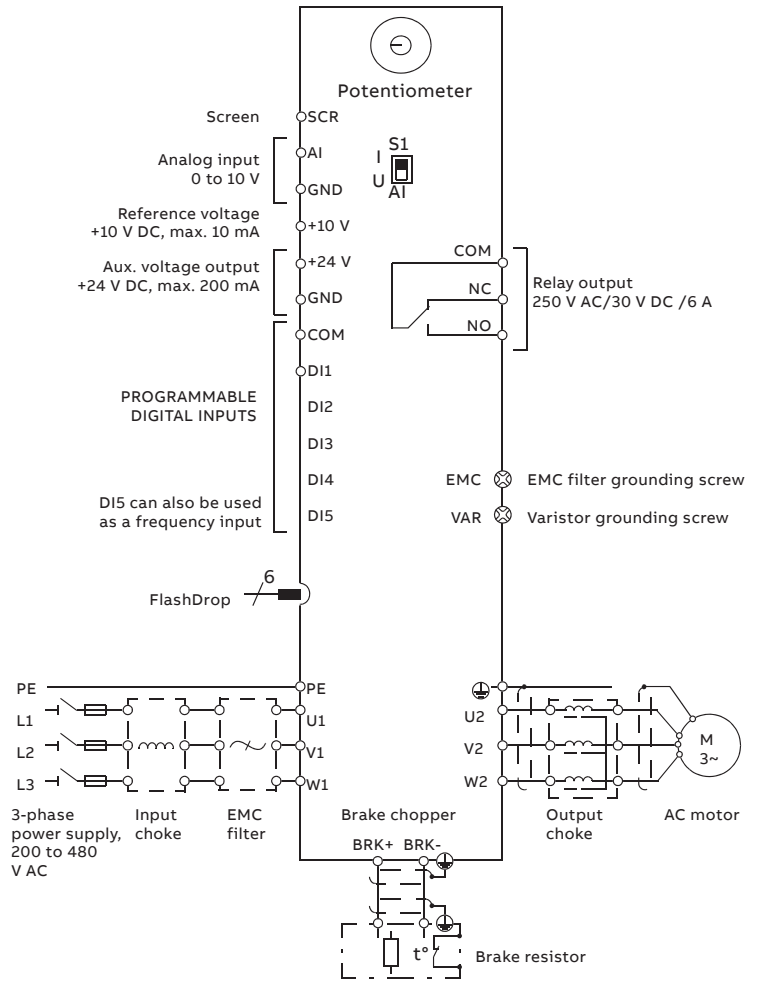

Dimensions and weights

Frame size	IP20/UL open				NEMA 1			
	H (mm)	W (mm)	D (mm)	Weight (kg)	H (mm)	W (mm)	D (mm)	Weight (kg)
R0	239	70	142	1.1	280	70	142	1.5
R1	239	70	142	1.3	280	70	142	1.7
R2	239	105	142	1.5	282	105	142	1.9



Types and voltages

Rated values *)		ABB ordering code Enclosure IP20	Electrical code/ reference code	ABB type code/ order code for IP20 units	Frame size	Price (Eur)
P_{motor} (kW)	I_{motor} (A)					
1-phase AC supply, 200 to 240 V						
0.37	2.4	68581940		ACS150-01E-02A4-2	R0	
0.75	4.7	68581966		ACS150-01E-04A7-2	R1	
1.1	6.7	68581974		ACS150-01E-06A7-2	R1	
1.5	7.5	68581982		ACS150-01E-07A5-2	R2	
2.2	9.8	68581991		ACS150-01E-09A8-2	R2	
3-phase AC supply, 200 to 240 V						
0.37	2.4	68582008		ACS150-03E-02A4-2	R0	
0.55	3.5	68582016		ACS150-03E-03A5-2	R0	
0.75	4.7	68582024		ACS150-03E-04A7-2	R1	
1.1	6.7	68582032		ACS150-03E-06A7-2	R1	
1.5	7.5	68582041		ACS150-03E-07A5-2	R1	
2.2	9.8	68582059		ACS150-03E-09A8-2	R2	
3-phase AC supply, 380 to 480 V						
0.37	1.2	68581737		ACS150-03E-01A2-4	R0	
0.55	1.9	68581745		ACS150-03E-01A9-4	R0	
0.75	2.4	68581753		ACS150-03E-02A4-4	R1	
1.1	3.3	68581761		ACS150-03E-03A3-4	R1	
1.5	4.1	68581788		ACS150-03E-04A1-4	R1	
2.2	5.6	68581796		ACS150-03E-05A6-4	R1	
3	7.3	68581800		ACS150-03E-07A3-4	R1	
4	8.8	68581818		ACS150-03E-08A8-4	R1	

*) The rated power and current values are valid for both pump and fan applications and heavy load applications.
Examples of typical heavy load applications include most extruders and compressors.

For more technical information see ACS150 catalog (3AFE68596114 EN) or ABB product guide (3AFE68401771 EN)

ABB machinery drives

ACS355, 0.37 to 22 kW

—
01
ACS355 frame sizes:
R0, R1, R2, R3, R4 and
IP66/IP67 variants

What is it?

The ACS355 is designed to be the fastest drive in terms of installation, setting parameters and commissioning. The drive is user-friendly, yet provides a wide range of built-in technology such as the safe torque off functionality and sequence programming which reduce the need for additional control electronics. The product

offers options and diverse functionality to cater to the needs set for speed and torque control of AC induction and permanent magnet motors.

The ACS355 drive meets the requirements of new drive users, installers, machine builders, system integrators and panel builders.



—
01

Dimensions and weights

Frame size	IP20/UL open				IP66/IP67			
	H (mm)	W (mm)	D (mm)	Weight (kg)	H (mm)	W (mm)	D (mm)	Weight (kg)
R0	239	70	161	1.1	—	—	—	—
R1	239	70	161	1.3	305	195	281	7.7
R2	239	105	165	1.5	—	—	—	—
R3	236	169	169	2.5	436	246	277	13
R4	244	260	169	4.4	—	—	—	—



Feature	Advantage	Benefit
Same height and depth across power range	Effective space usage	Less engineering and installation time
Assistant control panel with Help functions	Quick setup, easy configuration and commissioning, rapid fault diagnosis	Substantial time savings locating faults and implementing repairs, thereby reducing maintenance costs
Scalar and vector control	Optimum performance depending on application	Ensures the end-product is produced cost efficiently
Sequence programming	Logic programming included as standard with PLC-like functions	Reduces components and wiring in control system
Integrated EMC filter	High electromagnetic compatibility	Low EMC emissions in selected environments
Built-in brake chopper as standard	No need for an external brake chopper	Space savings, reduced installation cost
Safe torque off function (SIL3) as standard	Built-in and certified function that is used for prevention of an unexpected startup and other stopping related functions	Reduces the need for external safety components. Helps machine builders to fulfill the requirements of Machinery Directive 2006/42/EC.
High protection class variant (IP66/67) up to 7.5 kW	No need to design special enclosure for applications that require high ingress protection	Time and cost savings
Product variant for solar pumps	Drive converts PV energy from solar panels to AC current, it can be operated independent from the grid.	Long life time and reduced maintenance costs, energy use and pollution. Improved reliability in electricity supply.
FlashDrop tool	FlashDrop is used to quickly and easily set drive parameters. FlashDrop tool uploads drive parameters directly to unpowered drives. The tool can copy parameters from one drive to another or between a PC and a drive.	Time savings, especially with multiple drives

Inputs and outputs

The figure shows the ACS355 factory-set standard inputs and outputs. All inputs and outputs are freely programmable.

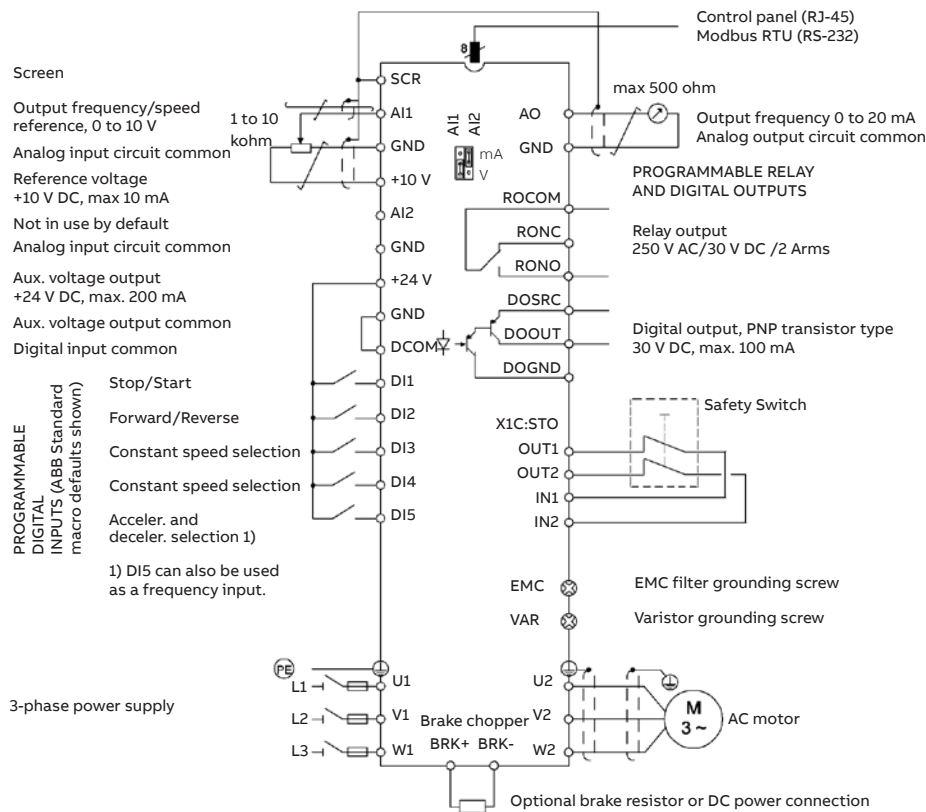

Types and voltages

Rated values *)		ABB ordering code Enclosure IP20	Electrical code/ reference code	ABB type code/order code for IP20 units	Frame size	Price (Eur)
P_{motor} (kW)	I_{motor} (A)					
1-phase AC supply, 200 to 240 V						
0.37	2.4	3AUA0000058166		ACS355-01E-02A4-2	R0	
0.75	4.7	3AUA0000058167		ACS355-01E-04A7-2	R1	
1.1	6.7	3AUA0000058168		ACS355-01E-06A7-2	R1	
1.5	7.5	3AUA0000058169		ACS355-01E-07A5-2	R2	
2.2	9.8	3AUA0000058170		ACS355-01E-09A8-2	R2	
3-phase AC supply, 200 to 240 V						
0.37	2.4	3AUA0000058171		ACS355-03E-02A4-2	R0	
0.55	3.5	3AUA0000058172		ACS355-03E-03A5-2	R0	
0.75	4.7	3AUA0000058173		ACS355-03E-04A7-2	R0	
1.1	6.7	3AUA0000058174		ACS355-03E-06A7-2	R1	
1.5	7.5	3AUA0000058175		ACS355-03E-07A5-2	R1	
2.2	9.8	3AUA0000058176		ACS355-03E-09A8-2	R2	
3	13.3	3AUA0000058177		ACS355-03E-13A3-2	R2	
4	17.6	3AUA0000058178		ACS355-03E-17A6-2	R2	
5.5	24.4	3AUA0000058179		ACS355-03E-24A4-2	R3	
7.5	31	3AUA0000058180		ACS355-03E-31A0-2	R4	
11	46.2	3AUA0000058181		ACS355-03E-46A2-2	R4	
3-phase AC supply, 380 to 480 V						
0.37	1.2	3AUA0000058182		ACS355-03E-01A2-4	R0	
0.55	1.9	3AUA0000058183		ACS355-03E-01A9-4	R0	
0.75	2.4	3AUA0000058184		ACS355-03E-02A4-4	R1	
1.1	3.3	3AUA0000058185		ACS355-03E-03A3-4	R1	
1.5	4.1	3AUA0000058186		ACS355-03E-04A1-4	R1	
2.2	5.6	3AUA0000058187		ACS355-03E-05A6-4	R1	
3	7.3	3AUA0000058188		ACS355-03E-07A3-4	R1	
4	8.8	3AUA0000058189		ACS355-03E-08A8-4	R1	
5.5	12.5	3AUA0000058190		ACS355-03E-12A5-4	R3	
7.5	15.6	3AUA0000058191		ACS355-03E-15A6-4	R3	
11	23.1	3AUA0000058192		ACS355-03E-23A1-4	R3	
15	31	3AUA0000058193		ACS355-03E-31A0-4	R4	
18.5	38	3AUA0000058194		ACS355-03E-38A0-4	R4	
22	44	3AUA0000058195		ACS355-03E-44A0-4	R4	

*) The rated power and current values are valid for both pump and fan applications and heavy load applications.
Examples of typical heavy load applications include most extruders and compressors.

Rated values *)		ABB ordering code Enclosure IP66/IP67	Electrical code/ reference code	ABB type code/order code for IP66/IP67 units	Frame size	Price (Eur)
P_{motor} (kW)	I_{motor} (A)					
3-phase AC supply, 200 to 240 V						
0.37	2.4	3AUA0000058148		ACS355-03X-02A4-2 + B063	R1	
0.55	3.5	3AUA0000058149		ACS355-03X-03A5-2 + B063	R1	
0.75	4.7	3AUA0000058150		ACS355-03X-04A7-2 + B063	R1	
1.1	6.7	3AUA0000058151		ACS355-03X-06A7-2 + B063	R1	
1.5	7.5	3AUA0000058152		ACS355-03X-07A5-2 + B063	R1	
2.2	9.8	3AUA0000058153		ACS355-03X-09A8-2 + B063	R3	
3	13.3	3AUA0000058154		ACS355-03X-13A3-2 + B063	R3	
4	17.6	3AUA0000058155		ACS355-03X-17A6-2 + B063	R3	
3-phase AC supply, 380 to 480 V						
0.37	1.2	3AUA0000058156		ACS355-03X-01A2-4 + B063	R1	
0.55	1.9	3AUA0000058157		ACS355-03X-01A9-4 + B063	R1	
0.75	2.4	3AUA0000058158		ACS355-03X-02A4-4 + B063	R1	
1.1	3.3	3AUA0000058159		ACS355-03X-03A3-4 + B063	R1	
1.5	4.1	3AUA0000058160		ACS355-03X-04A1-4 + B063	R1	
2.2	5.6	3AUA0000058161		ACS355-03X-05A6-4 + B063	R1	
3	7.3	3AUA0000058162		ACS355-03X-07A3-4 + B063	R1	
4	8.8	3AUA0000058163		ACS355-03X-08A8-4 + B063	R1	
5.5	12.5	3AUA0000058164		ACS355-03X-12A5-4 + B063	R3	
7.5	15.6	3AUA0000058165		ACS355-03X-15A6-4 + B063	R3	

X within the type code stands for E or U.

For more technical information, see ACS355 catalog (3AUA0000068569 EN) or ABB drives product guide (3AFE68401771 EN)

ABB general purpose drives

ACS310, 0.37 to 22 kW

—
01
ACS310 frame sizes:
R0, R1, R2, R3, R4

What is it?

The ACS310 drive is designed for squared torque applications such as booster pumps and supply and return fans. The drive includes a powerful set of features which benefit pump and fan applications including built-in PID controllers and pump and fan control (PFC) that varies the

drive's performance in response to changes in pressure, flow or other external data.

The ACS310 drive meets the requirements of new drive users, installers, machine builders, system integrators and panel builders.



—
01

Feature	Advantage	Benefit
Same height and depth across power range	Effective space usage	Less engineering and installation time
Commissioning assistants	Easy set up of parameters for PID controllers, real-time clock, serial communication, drive optimizer and drive startup	Time savings. Ensures all required parameters are set.
Pump and fan control (PFC)	One drive controls several pumps or fans. Auxiliary motors are driven according to the needed pump/fan capacity. One motor can be disengaged from the mains supply while others continue operating in parallel.	Saves cost of additional drives and external PLC. Longer life for pump or fan system while reducing maintenance time and costs. Maintenance can be carried out safely without stopping the process.
Pump protection functions	Preprogrammed features such as pipe cleaning, pipefill, inlet/outlet pressure supervision and detection of under- or overload	Reduces maintenance costs. Longer life for pump and fan system.
PID controllers	Varies the drive's performance according to the need of the application	Enhances production output, stability and accuracy
Energy efficiency counters	Illustrates saved energy, CO ₂ emissions and energy cost in local currency using a baseline determined from the energy consumed when the fan or pump is used directly online	Shows direct impact on energy bill and helps control operational expenditure (OPEX)
Embedded Modbus EIA-485 fieldbus interface	No need for external fieldbus options. Integrated and compact design.	Saves cost of an external fieldbus device. Increases reliability
FlashDrop tool	FlashDrop is a hand held tool that is used to quickly and easily set drive parameters. FlashDrop tool uploads drive parameters directly to unpowered drives. The tool can copy parameters from one drive to another or between a PC and a drive.	Time savings, especially with multiple drives

Inputs and outputs
 The figure shows the ACS310 factory-set standard inputs and outputs. All inputs and outputs are freely programmable.

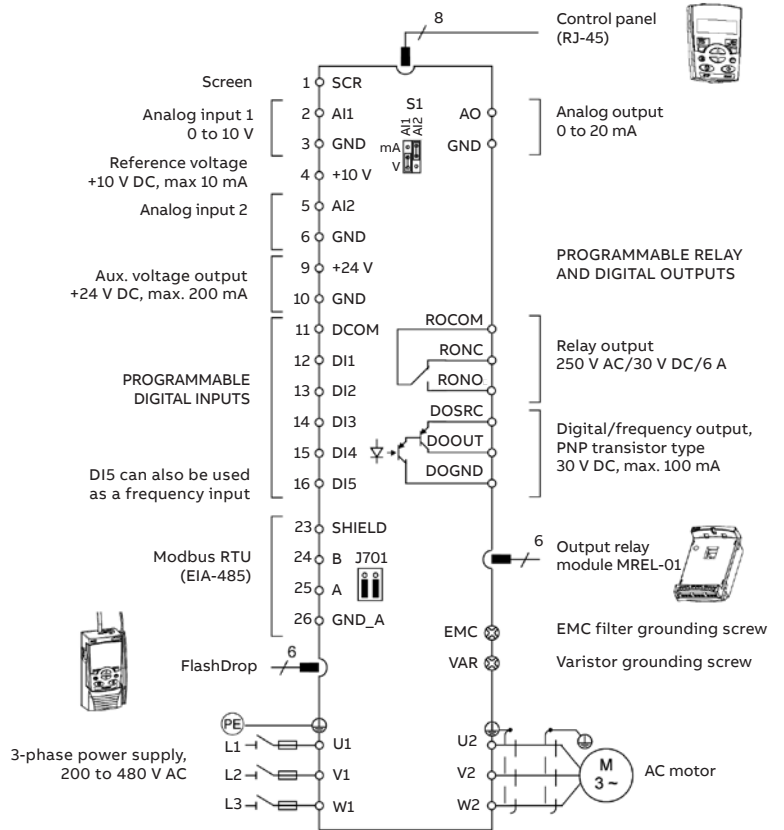

Dimensions and weights

Frame size	IP20/UL open				NEMA 1			
	H (mm)	W (mm)	D (mm)	Weight (kg)	H (mm)	W (mm)	D (mm)	Weight (kg)
R0	239	70	161	1.1	280	70	169	1.5
R1	239	70	161	1.3	280	70	169	1.7
R2	239	105	165	1.5	282	105	169	1.9
R3	236	169	169	2.5	299	169	177	3.1
R4	244	260	169	4.4	320	260	177	5



Types and voltages

Rated values *)		ABB ordering code Enclosure IP20	Electrical code/ reference code	ABB type code/order code for IP20 units	Frame size	Price (Eur)
P_{motor} (kW)	I_{motor} (A)					
1-phase AC supply, 200 to 240 V						
0.37	2.4	3AUA0000038701		ACS310-01X-02A4-2	R0	
0.75	4.7	3AUA0000038843		ACS310-01X-04A7-2	R1	
1.1	6.7	3AUA0000038844		ACS310-01X-06A7-2	R1	
1.5	7.5	3AUA0000038845		ACS310-01X-07A5-2	R2	
2.2	9.8	3AUA0000039071		ACS310-01X-09A8-2	R2	
3-phase AC supply, 200 to 240 V						
0.37	2.6	3AUA0000039087		ACS310-03X-02A6-2	R0	
0.55	3.9	3AUA0000039163		ACS310-03X-03A9-2	R0	
0.75	5.2	3AUA0000039192		ACS310-03X-05A2-2	R1	
1.1	7.4	3AUA0000039215		ACS310-03X-07A4-2	R1	
1.5	8.3	3AUA0000039218		ACS310-03X-08A3-2	R1	
2.2	10.8	3AUA0000039234		ACS310-03X-10A8-2	R2	
3	14.6	3AUA0000039307		ACS310-03X-14A6-2	R2	
4	19.4	3AUA0000039621		ACS310-03X-19A4-2	R2	
5.5	26.8	3AUA0000039622		ACS310-03X-26A8-2	R3	
7.5	34.1	3AUA0000039623		ACS310-03X-34A1-2	R4	
11	50.8	3AUA0000039624		ACS310-03X-50A8-2	R4	
3-phase AC supply, 380 to 480 V						
0.37	1.3	3AUA0000039625		ACS310-03X-01A3-4	R0	
0.55	2.1	3AUA0000039626		ACS310-03X-02A1-4	R0	
0.75	2.6	3AUA0000039627		ACS310-03X-02A6-4	R1	
1.1	3.6	3AUA0000039628		ACS310-03X-03A6-4	R1	
1.5	4.5	3AUA0000039629		ACS310-03X-04A5-4	R1	
2.2	6.2	3AUA0000039630		ACS310-03X-06A2-4	R1	
3	8.0	3AUA0000039631		ACS310-03X-08A0-4	R1	
4	9.7	3AUA0000039632		ACS310-03X-09A7-4	R1	
5.5	13.8	3AUA0000039633		ACS310-03X-13A8-4	R3	
7.5	17.2	3AUA0000039634		ACS310-03X-17A2-4	R3	
11	25.4	3AUA0000039635		ACS310-03X-25A4-4	R3	
15	34.1	3AUA0000039636		ACS310-03X-34A1-4	R4	
18.5	41.8	3AUA0000039637		ACS310-03X-41A8-4	R4	
22	48.4	3AUA0000039638		ACS310-03X-48A4-4	R4	





*) The rated power and current values are valid for both pump and fan applications and heavy load applications.

Examples of typical heavy load applications include most extruders and compressors. X within the type code stands for E or U.









For more technical information, see ACS310 catalog (3AUA0000051082 EN) or ABB drives product guide (3AFE68401771 EN)

Options

ACS480 and ACS580

ACS480 and 580 options						
	Type code	Electrical code/ ordering code		Price (Eur)	ACS480	ACS580
Control panels						
	ACS-AP-S	3AUA0000064884	Assistant control panel, delivered as standard if no other display option is selected. Features commissioning and diagnostic assistants, a multilingual display and a real-time clock.		●	●
	ACS-AP-I	3AUA0000088311	Industrial control panel replaces standard ACS-AP-S control panel. It offers compatibility to ACS880 drives.		●	●
	ACS-AP-W	3AXD50000025965	Control panel with Bluetooth interface		●	●
	CDUM-01	3AXD50000009843	Blank control panel cover replaces control panel (no control panel)			●
	DPMP-EXT	3AXD50000010763	Combined panel bus adapter and panel platform kit, enables mounting of the control panel on the cabinet door			●
	DPMP-EXT2	3AXD50000048730	Combined Blank panel with RJ45 connector and panel platform kit, enables mounting of the control panel on the cabinet door (RDUM-01 and DPMP-21)		●	
	DPMP-01	3AUA0000108878	Control panel mounting platform (flush)		●	●
	DPMP-02	3AXD50000009374	Control panel mounting platform (surface)		●	●
	DPMP-04 *)	3AXD50000217717	Control panel mounting kit for outdoor installation		●	●
	CDPI-01	3AXD50000004419				●
	CDPI-02 *)	3AXD50000313204			●	
	RDUM-01	3AXD50000040008	Blank panel with RJ45 connector		●	

*) For availability please contact your local ABB.

ACS480 and 580 options						
	Type code	Electrical code/ ordering code		Price (Eur)	ACS480	ACS580
Fieldbus adapter modules ¹⁾						
	FDNA-01	68469341	DeviceNet™ protocol		●	●
	FPBA-01	68469325	PROFIBUS DP protocol		●	●
	FCAN-01	68469376	CANopen® protocol		●	●
	FCNA-01	3AUA0000094512	ControlNet protocol		●	●
	FEIP-21	3AXD50000192786	Two-Port EtherNet/IP protocol		●	●
	FMBT-21	3AXD50000049964	Two-Port Modbus/TCP protocol		●	●
	FPNO-21	3AXD50000192779	Two-Port PROFINET IO protocol		●	●
	FECA-01	3AUA0000072069	EtherCAT® protocol		●	●
	FSCA-01	3AUA0000031336	Modbus/RTU		●	●
	FEPL-02	3AUA0000072120	POWERLINK protocol		●	●
Remote monitoring						
	NETA-21	3AUA0000094517	Ethernet adapter with remote monitoring access can send process data, data logs and event messages independently, without a PLC or a dedicated on-site computer. It has an internal web server for configuration and drive access.		●	●
Input/output extension module						
	CMOD-01	3AXD50000004420	External 24 V AC and DC input 2 x RO and 1 x DO			●
	CMOD-02	3AXD50000004418	External 24 V AC and DC input and isolated PTC interface			●
	CHDI-01	3AXD50000004431	Six 115/230 V AC digital inputs and two relay outputs			●
	CBAI-01	3AXD50000137954	Bipolar analog I/O extension module			●
	CPTC-02	3axd50000033144	ATEX certified PTC interface and external 24 V			●
	BIO-01	3AXD50000191635	I/O extension module used together with a fieldbus module		●	
	BAPO-01	3AXD50000022164	Auxiliary power extension module External 24 V DC input		●	
	BREL-01	3AXD50000022162	Relay output extension module 4 x RO		●	
Drive construction options						
	IP20 shrouds for finger safe operation	+B051	Factory-made enclosure for the IP20 protection class on ACS580-04 drives			●
	Full-size input power cable terminals	+H370	For connecting the ACS580-04 drive to busbars or to multiple cables			●

¹⁾ One slot available for a fieldbus adapter. Modbus EIA-485 built-in as standard.

ACS480 and 580 options

Type code	Electrical code/ ordering code	Price (Eur)	ACS480	ACS580
-----------	-----------------------------------	----------------	--------	--------

Brake units



ACS580 frame sizes R1, R2 and R3 and ACS480 frame sizes R1, R2, R3 and R4 are delivered with an integrated brake chopper as standard. Other units can use external braking choppers and resistors or integrated braking chopper and resistor unit.

			Reference brake resistors are listed in the manuals. Make sure to dimension them correctly.	●	●
ACS-BRK-D	64102931		Integrated braking chopper and resistor. Resistor's resistance 10.5 ohm, continuous output power 7 kW, maximum output power for 20 s is 42 kW for 380 to 480 V units		●
NBRA-658	59006428		Braking chopper module. Maximum braking power depends on a braking cycle, drive's typecode and brake resistor. For further details, please refer to the hardware manual.		●
NBRA-659	59006436				●

Flange mounting kits

		3AXD50000105311	Flange mounting kit for the frame size R1 IP21		●
		3AXD50000105328	Flange mounting kit for the frame size R2 IP21		●
		3AXD50000105335	Flange mounting kit for the frame size R3 IP21		●
		3AXD50000031460	Flange mounting kit for the frame size R4 IP21		●
		3AXD50000031461	Flange mounting kit for the frame size R5 IP21		●
6438177339694		3AXD50000018852	Flange mounting kit for the frame size R6, IP21		●
6438177339700		3AXD50000018853	Flange mounting kit for the frame size R7, IP21		●
6438177339816		3AXD50000018854	Flange mounting kit for the frame size R8, IP21		●
6438177339823		3AXD50000018855	Flange mounting kit for the frame size R9, IP21		●

PC tools, configuration tools and adapters

	Drive Composer entry	Download free from www.abb.com/drives	Drive Composer PC tool for startup, configuration, monitoring and process tuning. PC tool is connected to the drive's control panel via USB interface.	●	●
	DCPT-01 Drive Composer pro	3AUA0000108087 (1 user license) 3AUA0000145150 (10 users license) 3AUA0000145151 (20 users license)	Drive Composer pro provides the same standard functionality as the free version and some additional features, like graphic control diagrams. The tool has fast monitoring capabilities of multiple signals from several drives in the panel bus. Full backup and restore functions are also included.	●	●
	CCA-01	3AXD50000019865	Cold configuration adapter provides serial communication interface to unpowered drives. This adapter ensures safety isolation of both serial communication and control board power supply. The power supply is taken from PC USB port.	●	●

ABB

The control panel features a monochrome LCD screen displaying the following information:

Remote	1147F01	16.8 Hz
Output frequency	16.78	Hz
Motor current	5.56	A
DC voltage	550.27	V
Options	1518	Menu

Below the screen is a control keypad with the following buttons:





- Stop (red triangle with a slash)
- Loc/Rem (lock/unlock)
- Start (green diamond)
- Navigation buttons: Up, Down, Left, Right, and a central Enter button.
- Help button (question mark)
- USB port

ABB

Partial view of another ABB drive control panel, showing the top portion of the LCD screen and the Stop button.











Options





ACS55 and ACS150



ACS55 options			
	Type code	Electrical code/ ordering code	Price (Eur)
Potentiometer			
	ACS50-POT	68226716	Integrated potentiometer for adjusting the motor speed
DriveConfig kit			
	RFDT-02	68973988	PC tool for programming of ACS55 drives in larger quantities without the need for a power connection
ACS150 options			
	Type code	Electrical code/ ordering code	Price (Eur)
NEMA 1 enclosure kit			
	MUL1-R1	68566398	NEMA 1 enclosure kit for finger protection and for protection against dirt and dust, available for frame sizes R0 to R2
EMC filters			
	RFI-11	68902371	Compatibility with category C1 and C2, 1-phase, 0.37 kW
	RFI-12	68902401	Compatibility with category C1 and C2, 1-phase, 0.75 to 1.1 kW
	RFI-13	68902410	Compatibility with category C1 and C2, 1-phase, 1.5 to 2.2 kW
	RFI-32	68902495	Compatibility with category C1 and C2, 3-phase, 0.37 to 4.0 kW
Low leakage current filters			
	LRFI-31	3AUA0000050644	Low leakage current filters are ideal for installations where residual current devices (RCD) are required and leakage current needs to be below 30 mA
	LRFI-32	3AUA0000050645	
PC tools and adapters			
	MFDT-01	68566380	FlashDrop is a powerful palm sized tool for fast and easy parameter selecting and setting. It gives the possibility to hide selected parameters to protect the machine.



Options

ACS355

ACS355 options			
	Type code	Electrical code/ ordering code	Price (Eur)
Potentiometer and control panels			
	MPOT-01	68566282	Integrated potentiometer for adjusting the motor speed
			- Control panel cover, delivered with ACS355 drives as standard
	ACS-CP-C	64739000	Basic control panel with numeric display and large buttons
	ACS-CP-A	64691473	Assistant control panel with commissioning and diagnostic assistants. Features a multilingual display and a real-time clock.
	ACS/H-CP-EXT	68294673	Control panel mounting kit, enables mounting of the control panel on the cabinet door
	ACS/H-CP-EXT-IP66	68829593	Control panel mounting kit with IP66 enclosure, enables mounting of the control panel on the cabinet door
	OPMP-01	3AUA0000013086	Control panel holder mounting kit. Includes a panel platform that enables the panel to be removed in the same way as a drive-mounted panel.
NEMA 1 enclosure kits			
	MUL1-R1	68566398	NEMA 1 enclosure kit for finger protection and for protection against dirt and dust, available for frame sizes R0 to R2. Total height increases by 43 mm and depth by 8 mm.
	MUL1-R3	68566410	NEMA 1 enclosure kit for finger protection and for protection against dirt and dust, available for frame size R3. Total height increases by 63 mm and depth by 8 mm.
	MUL1-R4	3AUA0000023888	NEMA 1 enclosure kit for finger protection and for protection against dirt and dust, available for frame size R4. Total height increases by 76 mm and depth by 8 mm.
		B063	IP66/NEMA 4X enclosure Available up to 7.5 kW Has to be ordered together with ACS355 drive

ACS355 options			
	Type code	Electrical code/ ordering code	Price (Eur)
Extension modules			
	MTAC-01	68566355	Pulse encoder interface module
	MREL-01	3AUA0000031854	Relay output extension module. The optional MREL-01 module offers three additional relay outputs, which can be configured for different functions with parameters.
	MPOW-01	3AUA0000059808	Auxiliary power module
Connection options			
	Cable gland kit	Frame R1: 3AUA0000045483 Frame R3: 3AUA0000045484	Cable gland kit for the IP66/67 drive variant
	Input switch kit	F278	Input switch kit for the IP66/67 drive variant, factory installed variant
Pressure compensation			
	C169	3AUA0000045485	Pressure compensation valve for IP66/67 variant to prevent water condensation within the enclosure.
Fieldbus adapter modules			
	FCAN-01	68469376	CANopen® protocol
	FPBA-01	68469325	PROFIBUS DP protocol
	FDNA-01	68469341	DeviceNet™ protocol
	FMBA-01	68469881	EIA-485/Modbus RTU protocol
	FENA-01	68469422	Ethernet (EtherNet/IP, Modbus/TCP, PROFINET IO)
	FENA-21	3AUA0000089109	2-port Ethernet (EtherNet/IP, Modbus/TCP, PROFINET IO)
	FECA-01	3AUA0000072069	Ethernet/EtherCAT® protocol
	FCNA-01	3AUA0000094512	ControlNet protocol
	FEPL-02	3AUA0000072120	POWERLINK protocol
Remote monitoring			
	SREA-01	3AUA0000039179	Ethernet adapter with remote monitoring access can send process data, data logs and event messages independently, without a PLC or a dedicated on-site computer. It has an internal web server for configuration and drive access.
Braking resistors			
	CBR-V 160	68691770	Compatibility with 1-phase, 200 to 240 V, units up to 2.2 kW Compatibility with 3-phase, 200 to 240 V, units up to 2.2 kW
	CBR-V 210	68569311	Compatibility with 3-phase, 380 to 480 V, units up to 2.2 kW
	CBR-V 260	68691796	Compatibility with 3-phase, 200 to 240 V, units 3 and 4 kW
	CBR-V 460	68455685	Compatibility with 3-phase, 380 to 480 V, units from 3 to 7.5 kW
	CBR-V 660	68897921	Compatibility with 3-phase, 380 to 480 V, unit 11 kW
	CBT-H 560	3AUA0000023613	Compatibility with 3-phase, 200 to 240 V, units from 5.5 to 11 kW Compatibility with 3-phase, 380 to 480 V, units from 15 to 22 kW

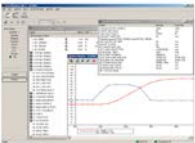



ACS355 options				
	Type code	Electrical code/ ordering code		Price (Eur)
Input chokes				
	CHK-A1	68418500	Compatibility with 1-phase, 200 to 240 V, unit 0.37 kW	
	CHK-B1	68418518	Compatibility with 1-phase, 200 to 240 V, unit 0.75 kW	
	CHK-C1	68418526	Compatibility with 1-phase, 200 to 240 V, units from 1.1 to 1.5 kW	
	CHK-D1	68418534	Compatibility with 1-phase, 200 to 240 V, unit 2.2 kW	
	CHK-01	68711185	Compatibility with 3-phase, 200 to 240 V, unit 0.37 kW Compatibility with 3-phase, 380 to 480 V, units from 0.37 to 1.1 kW	
	CHK-02	68711193	Compatibility with 3-phase, 200 to 240 V, unit 0.55 kW Compatibility with 3-phase, 380 to 480 V, units from 1.5 to 3 kW	
	CHK-03	68711215	Compatibility with 3-phase, 200 to 240 V, units 0.75 to 1 kW Compatibility with 3-phase, 380 to 480 V, units from 4 to 5.5 kW	
	CHK-04	68711231	Compatibility with 3-phase, 200 to 240 V, units 1.5 to 4 kW Compatibility with 3-phase, 380 to 480 V, units from 7.5 to 11 kW	
	CHK-05	68711240	Compatibility with 3-phase, 380 to 480 V, unit 15 kW	
	CHK-06	68711266	Compatibility with 3-phase, 200 to 240 V, units 5.5 to 11 kW Compatibility with 3-phase, 380 to 480 V, units from 18.5 to 22 kW	
Output chokes				
	ACS-CHK-B3	64324063	Compatibility with 1-phase, 200 to 240 V, units up to 0.75 kW Compatibility with 3-phase, 200 to 240 V, units up to 0.75 kW Compatibility with 3-phase, 380 to 480 V, units up to 1.1 kW	
	ACS-CHK-C3	64324080	Compatibility with 1-phase, 200 to 240 V, units from 1.1 to 2.2 kW Compatibility with 3-phase, 200 to 240 V, units from 1.1 to 2.2 kW Compatibility with 3-phase, 380 to 480 V, units from 1.5 to 2.2 kW	
	NOCH-0016-6x	61445412	Compatibility with 3-phase, 200 to 240 V, units from 3 to 4 kW Compatibility with 3-phase, 380 to 480 V, units from 3 to 7.5 kW	
	NOCH-0030-6x	61445439	Compatibility with 3-phase, 200 to 240 V, units from 5.5 to 7.5 kW Compatibility with 3-phase, 380 to 480 V, units from 11 to 18.5 kW	
	NOCH-0070-6x	61445455	Compatibility with 3-phase, 200 to 240 V, unit 11 kW Compatibility with 3-phase, 380 to 480 V, unit 22 kW	

ACS355 options			
	Type code	Electrical code/ ordering code	Price (Eur)
EMC filters			
	RFI-11	68902371	Compatibility with category C1 and C2, 1-phase, 0.37 kW
	RFI-12	68902401	Compatibility with category C1 and C2, 1-phase, 0.75 to 1.1 kW
	RFI-13	68902410	Compatibility with category C1 and C2, 1-phase, 1.5 to 2.2 kW
	RFI-32	68902495	Compatibility with category C1 and C2, 3-phase, 0.37 to 4.0 kW
	RFI-33	68902509	Compatibility with category C1 and C2, 3-phase, 5.5 to 11 kW
	RFI-34	3AUA0000023611	Compatibility with category C1 and C2, 3-phase, 15 to 22 kW
Low leakage current filters			
	LRFI-31	3AUA0000050644	Compatibility with 3-phase, 380 to 480 V, units 0.37 to 2.2 kW
	LRFI-32	3AUA0000050645	Compatibility with 3-phase, 380 to 480 V, units 3 to 4 kW
PC tools, configuration tools and adapters			
	DriveWindow Light	64532871	DriveWindow Light is a PC program for easy commissioning and drive monitoring. Includes an RS-232 cable as standard for connecting the drive to the PC.
	MFDT-01	68566380	FlashDrop is a powerful hand held tool that is used to quickly and easily set drive parameters. FlashDrop tool uploads drive parameters directly to unpowered drives and stores up to 20 different drive parameter sets.
	USB serial adapter	68583667	USB, an RS-232 adapter to be used between the PC and the drive. Not needed if the computer has an RS-232 port.

Options

ACS310

ACS310 options			
	Type code	Electrical code/ ordering code	Price (Eur)
Potentiometer and control panels			
		–	Control panel cover, delivered with ACS310 drives as standard
	ACS-CP-C	64739000	Basic control panel with numeric display and large buttons
	ACS-CP-A	64691473	Assistant control panel with commissioning and diagnostic assistants. Features a multilingual display and a real-time clock.
	ACS/H-CP-EXT	68294673	Control panel mounting kit, enables mounting of the control panel on the cabinet door
	ACS/H-CP-EXT-IP66	68829593	Control panel mounting kit with IP66 enclosure, enables mounting of the control panel on the cabinet door
	OPMP-01	3AUA0000013086	Control panel holder mounting kit. Includes a panel platform that enables the panel to be removed in the same way as a drive-mounted panel.
NEMA 1 enclosure kits			
	MUL1-R1	68566398	NEMA 1 enclosure kit for finger protection and for protection against dirt and dust, available for frame sizes R0 to R2. Total height increases by 43 mm and depth by 8 mm.
	MUL1-R3	68566410	NEMA 1 enclosure kit for finger protection and for protection against dirt and dust, available for frame size R3. Total height increases by 63 mm and depth by 8 mm.
	MUL1-R4	3AUA0000023888	NEMA 1 enclosure kit for finger protection and for protection against dirt and dust, available for frame size R4. Total height increases by 76 mm and depth by 8 mm.
Extension module			
	MREL-01	3AUA0000031854	Relay output extension module. The optional MREL-01 module offers three additional relay outputs, which can be configured for different functions with parameters.
Remote monitoring			
	SREA-01	3AUA0000039179	Ethernet adapter with remote monitoring access can send process data, data logs and event messages independently, without a PLC or a dedicated on-site computer. It has an internal web server for configuration and drive access.

ACS310 options			
	Type code	Electrical code/ ordering code	Price (Eur)
Input chokes			
	CHK-01	68711185	Compatibility with 3-phase, 200 to 240 V, unit 0.37 kW Compatibility with 3-phase, 380 to 480 V, units from 0.37 to 1.1 kW
	CHK-02	68711193	Compatibility with 3-phase, 200 to 240 V, unit 0.55 kW Compatibility with 3-phase, 380 to 480 V, units from 1.5 to 3 kW
	CHK-03	68711215	Compatibility with 3-phase, 200 to 240 V, units 0.75 to 1 kW Compatibility with 3-phase, 380 to 480 V, units from 4 to 5.5 kW
	CHK-04	68711231	Compatibility with 3-phase, 200 to 240 V, units 1.5 to 4 kW Compatibility with 3-phase, 380 to 480 V, units from 7.5 to 11 kW
	CHK-05	68711240	Compatibility with 3-phase, 380 to 480 V, unit 15 kW
	CHK-06	68711266	Compatibility with 3-phase, 200 to 240 V, units 5.5 to 11 kW Compatibility with 3-phase, 380 to 480 V, units from 18.5 to 22 kW
Output chokes			
	ACS-CHK-B3	64324063	Compatibility with 1-phase, 200 to 240 V, units up to 0.75 kW Compatibility with 3-phase, 200 to 240 V, units up to 0.75 kW Compatibility with 3-phase, 380 to 480 V, units up to 1.1 kW
	ACS-CHK-C3	64324080	Compatibility with 1-phase, 200 to 240 V, units from 1.1 to 2.2 kW Compatibility with 3-phase, 200 to 240 V, units from 1.1 to 2.2 kW Compatibility with 3-phase, 380 to 480 V, units from 1.5 to 2.2 kW
	NOCH-0016-6x	61445412	Compatibility with 3-phase, 200 to 240 V, units from 3 to 4 kW Compatibility with 3-phase, 380 to 480 V, units from 3 to 7.5 kW
	NOCH-0030-6x	61445439	Compatibility with 3-phase, 200 to 240 V, units from 5.5 to 7.5 kW Compatibility with 3-phase, 380 to 480 V, units from 11 to 18.5 kW
	NOCH-0070-6x	61445455	Compatibility with 3-phase, 200 to 240 V, unit 11 kW Compatibility with 3-phase, 380 to 480 V, unit 22 kW
Low leakage current filters			
	LRFI-31	3AUA0000050644	Compatibility with 3-phase, 380 to 480 V, units 0.37 to 2.2 kW
	LRFI-32	3AUA0000050645	Compatibility with 3-phase, 380 to 480 V, units 3 to 4 kW
EMC filters			
	RFI-32	68902495	Compatibility with category C1 and C2, 3-phase, 0.37 to 4.0 kW
	RFI-33	68902509	Compatibility with category C1 and C2, 3-phase, 5.5 to 11 kW
	RFI-34	3AUA0000023611	Compatibility with category C1 and C2, 3-phase, 15 to 22 kW

ACS310 options



	Type code	Electrical code/ ordering code	Price (Eur)
PC tools, configuration tools and adapters			
	DriveWindow Light	64532871	DriveWindow Light is a PC program for easy commissioning and drive monitoring. Includes an RS-232 cable as standard for connecting the drive to the PC.
	MFD-01	68566380	FlashDrop is a powerful hand held tool that is used to quickly and easily set drive parameters. FlashDrop tool uploads drive parameters directly to unpowered drives and stores up to 20 different drive parameter sets.
	USB serial adapter	68583667	USB, an RS-232 adapter to be used between the PC and the drive. Not needed if the computer has an RS-232 port.

ABB softstarters

How we are helping the industry

A softstarter from ABB offers you several values and benefits. Whether you are a consultant, OEM, panel builder or end-user, a softstarter will add to your business value by securing motor reliability, improving installation efficiency and increasing application productivity.

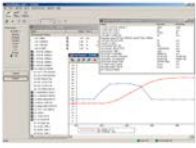

SECURE
MOTOR
Reliability

ABB softstarters help increase your motor's lifetime by protecting it from electrical stress. Starting currents are easily optimized to your load, application and motor size. Over ten motor protection features are included to keep your motor safe from different load and network irregularities.



IMPROVE
INSTALLATION
Efficiency

Reduce your installation time and panel size by having all features you need built into your softstarter. Our softstarters are easy to install thanks to their compact design and many built-in features. The built-in bypass saves energy and space while reducing heat generation. A complete motor starting solution in one unit.



INCREASE
APPLICATION
Productivity

Reduce the number of stops in your production by allowing your softstarter to do more than just starting. Our softstarters reduce the mechanical stress on your motor application, which will increase your uptime. Torque control, pump cleaning, motor brake and many other features enable you to operate your process at its full potential.

ABB softstarters

Selection tool

Step	Process
1	Determine softstarter series First, determine the softstarter series that fulfill the needs of the application and motor. Use the guide on the left to explore the three series and the power range each one covers.
2	Match the softstarter size with the motor current When the softstarter series is selected, the correct size should now be determined. The selection of a softstarter is based on the current. Find the softstarter that corresponds to the motor current.
3	Fine tune and select the correct size The last step is to fine tune the selection, and there are three different factors to consider: a. Normal or a heavy load: If the load is characterized as a heavy load, select the next size softstarter in the series. b. High ambient temperature c. High altitude Use the equations below to find the correct de-rating equation for each softstarter type.

Note: If the application is more complicated and there are specific requirements on acceleration time, maximum starting current or many starts per hour, the software Prosoft should be used for a fine tuned selection. [Link](#)



For a more precise selection, use the online softstarter selection tool available by scanning the shown QR code or using the selection tool available on: econfigure.xe.abb.com/global

Altitude formula

De-rate for altitudes between 1000-4000 m or 3280-13123 ft with the following formula for all softstarters:

In meters: % of I_e = 100 - (x-1000)/150

In feet: % of FLA = 100 - (y-3280)/480

Where x/y is the actual altitude in m/ft

Temperature formula

PSTX and PSR

In Celsius: 40...60 °C: Reduce I_e with 0.8%/°C

In Fahrenheit: 104...140 °F: Reduce FLA with 0.44%/°F

PSE

In Celsius: 40...60 °C: Reduce I_e with 0.6%/°C

In Fahrenheit: 104...140 °F: Reduce FLA with 0.33%/°F

Typical applications

Normal duty start	Heavy duty
Bow thrusters	Centrifugal fan
Compressors	Crusher
Elevator	Mixer
Centrifugal pump	Conveyor belt (long)
Conveyor belt (short)	Mill
Escalators	Stirrer

PSTX – the advanced range
<ul style="list-style-type: none"> When full control and motor protection is needed When an advanced softstarter with an extensive functionality is needed When motor is connected inside delta or in 690 V
PSE – the efficient range
<ul style="list-style-type: none"> When there is limited space When common softstarter functions and protections are needed When operating a pump
PSR – the compact range
<ul style="list-style-type: none"> When standard softstarter benefits and values are requested When operating a small motor When up to 100 starts per hour are requested

Feature	PSR	PSE	PSTX	
Current limit	-	●	●	Secure motor reliability
Current limit ramp and dual current limit	-	-	●	
Electronic motor overload protection	-	●	●	
Dual overload protection	-	-	●	
Underload protection	-	●	●	
Power factor underload protection	-	-	●	
Locked rotor protection	-	●	●	
Current/Voltage imbalance protection	-	-	●	
Phase reversal protection	-	-	●	
Customer defined protection	-	-	●	
Motor heating	-	-	●	Improve installation efficiency
PTC/PT100 input for motor protection	-	-	●	
Oversvoltage/undersvoltage protection	-	-	●	
Earth-fault protection	-	-	●	
Built-in bypass	●	●	●	
Inside-delta connection possible	-	-	●	
Graphical display and keypad	-	●	●	
Detachable keypad	-	-	●	
Motor runtime and start count	-	-	●	
Programmable warning functions	-	-	●	
Diagnostics	-	-	●	Increase application productivity
Overload time-to-trip	-	-	●	
Overload time-to-cool	-	-	●	
Analog output	-	●	●	
Fieldbus communication	○	●	●	
Event log	-	○	●	
Multiple languages	-	-	17	
Electricity metering	-	-	●	
Torque control	-	●	●	
Torque limit	-	-	●	
Coated PCBA	-	●	●	
Limp mode	-	-	●	
Jog with slow speed forward/ reverse	-	-	●	
Dynamic brake	-	-	●	
Stand still brake	-	-	●	
Sequence start	-	-	●	
Full voltage start	-	-	●	
Kick start	-	●	●	
Automatic pump cleaning	-	-	●	

● = Standard
○ = Option
— = Not available

ABB softstarters

PSR – The compact range



Technical data

- Operational voltage: 208...600 V AC
- Wide rated control supply voltage: 100...240 V AC, 50/60 Hz or 24 V AC/DC
- Rated operational current: 3...105 A
- Two-phase controlled
- Soft start with voltage ramp
- Soft stop with voltage ramp
- Built-in bypass for energy saving and easy installation
- Easy setup by three potentiometers
- Fieldbus communication with fieldbus plug adaptor and the FieldBusPlug

- Run and Top of Ramp relays available for monitoring
- Connection kits available for connection to ABB's manual motor starters (MMS)

Available communication protocols:

- Modbus RTU
- PROFIBUS
- DeviceNet

Certifications and approvals:

- CE, cULus, CCC, EAC, ANCE, C-tick, KC



Reduce the electrical stresses and keep the motor protected with the MMS

The PSR reduces the starting current for the motor. The possibility to connect it to the manual motor starter makes it possible to build a compact and complete starting solution with overload and short-circuit protection.



Saving time and money with built-in bypass and easy set-up

On the PSR, the bypass is built in and verified by ABB, saving you time during installation and space in your panel. Set-up is done through three potentiometers making it very fast and easy.



Reduce the mechanical stresses on your motor

Soft start and stop with PSR will reduce mechanical wear and tear on the application and increase the availability and uptime.

PSR Dimensions and weight

Frame size	H (mm)	W (mm)	D (mm)	Weight (kg)	Weight (lb)
PSR3...16	140	45	113.5	0.45	0.99
PSR25...30	160	45	128	0.60	1.43
PSR37...45	187	54	153	1.0	2.20
PSR60...105	220	70	180	2.27	5.0



Ordering details

Normal start, class 10, in-line



For a more precise selection, use the online softstarter selection tool available by scanning the shown QR code or using the selection tool available on: econfigure.xe.abb.com/global

Rated operational voltage U_e , 208...600 V AC
Rated control supply voltage, U_s , 100...240 V AC, 50/60 Hz

IEC				UL/CSA				Type	Order code	Price (Eur)
Rated operational power		Current		Rated operational power		Current				
230 V P_e (kW)	400 V P_e (kW)	500 V P_e (kW)	I_e (A)	200/208 V P_e (hp)	220/240 V P_e (hp)	440/480 V P_e (hp)	550/600 V P_e (hp)			
0.75	1.5	2.2	3.9	0.5	0.75	2	2	3.4	PSR3-600-70	1SFA896103R7000
1.5	3	4	6.8	1	1.5	3	5	6.1	PSR6-600-70	1SFA896104R7000
2.2	4	4	9	2	2	5	7.5	9	PSR9-600-70	1SFA896105R7000
3	5.5	5.5	12	3	3	7.5	10	11	PSR12-600-70	1SFA896106R7000
4	7.5	7.5	16	3	5	10	10	15.2	PSR16-600-70	1SFA896107R7000
5.5	11	15	25	7.5	7.5	15	20	24.2	PSR25-600-70	1SFA896108R7000
7.5	15	18.5	30	7.5	10	20	25	28	PSR30-600-70	1SFA896109R7000
7.5	18.5	22	37	10	10	25	30	34	PSR37-600-70	1SFA896110R7000
11	22	30	45	15	15	30	40	46.2	PSR45-600-70	1SFA896111R7000
15	30	37	60	20	20	40	50	59.4	PSR60-600-70	1SFA896112R7000
22	37	45	72	20	25	50	60	68	PSR72-600-70	1SFA896113R7000
22	45	55	85	25	30	60	75	80	PSR85-600-70	1SFA896114R7000
30	55	55	105	30	40	75	100	104	PSR105-600-70	1SFA896115R7000

Rated operational voltage U_e , 208...600 V AC
Rated control supply voltage, U_s , 24 V AC/DC, 50/60 Hz

0.75	1.5	2.2	3.9	0.5	0.75	2	2	3.4	PSR3-600-11	1SFA896103R1100
1.5	3	4	6.8	1	1.5	3	5	6.1	PSR6-600-11	1SFA896104R1100
2.2	4	4	9	2	2	5	7.5	9	PSR9-600-11	1SFA896105R1100
3	5.5	5.5	12	3	3	7.5	10	11	PSR12-600-11	1SFA896106R1100
4	7.5	7.5	16	3	5	10	10	15.2	PSR16-600-11	1SFA896107R1100
5.5	11	15	25	7.5	7.5	15	20	24.2	PSR25-600-11	1SFA896108R1100
7.5	15	18.5	30	7.5	10	20	25	28	PSR30-600-11	1SFA896109R1100
7.5	18.5	22	37	10	10	25	30	34	PSR37-600-11	1SFA896110R1100
11	22	30	45	15	15	30	40	46.2	PSR45-600-11	1SFA896111R1100
15	30	37	60	20	20	40	50	59.4	PSR60-600-11	1SFA896112R1100
22	37	45	72	20	25	50	60	68	PSR72-600-11	1SFA896113R1100
22	45	55	85	25	30	60	75	80	PSR85-600-11	1SFA896114R1100
30	55	55	105	30	40	75	100	104	PSR105-600-11	1SFA896115R1100

ABB softstarters

PSE – The efficient range



Technical data

- Operational voltage: 208...600 V AC
- Wide rated control supply voltage: 100...250 V AC, 50/60 Hz
- Rated operational current: 18...370 A
- Two-phase controlled
- Voltage ramp and torque control for both start and stop
- Current limit
- Kick-start
- Built-in bypass for energy saving and easy installation
- Coated PCBA protecting from dust, moist and corrosive atmosphere
- Illuminated display that uses symbols to become language neutral
- External keypad rated IP66 (Type 1, 4X,12) as an option

- Built-in Modbus RTU for monitoring and control
- Analog output for display of motor current
- Electronic overload protection
- Underload protection
- Locked rotor protection

Available communication protocols:

- Built-in: Modbus RTU
- Fieldbus plug (optional): PROFIBUS, DeviceNet, Modbus TCP

Certifications and approvals:

- CE, cULus, CCC, EAC, ANCE, C-tick, ABS, DNV GL, Lloyd's Register, CCS, PRS, Class NK, KC



Basic motor protection and current limit

The PSE includes the most important protections for handling different load situations that can happen to pumps e.g. overload and underload. The current limit gives you more control of the motor during start and allows you to start your motor in weaker networks.



Saving time and money with built-in bypass and compact design

On the PSE, the bypass is built in and verified by ABB, saving you time during installation and space in your panel. The keypad is language neutral and illuminated for easy set-up and operation in field. The compact design makes installation fast and easy.



Torque control for elimination of water hammering in pumps

Torque control is the most efficient way to stop a full speed pump. The PSE has a special torque stop ramp that is designed together with a pump manufacturer to eliminate water hammering in an optimal way.

PSE Dimensions and weight

Frame size	H (mm)	W (mm)	D (mm)	Weight (kg)	Weight (lb)
PSE18...60	245	90	185.5	2.4	5.3
PSE72...105	245	90	185.5	2.5	5.5
PSE142...170	295	130	219.5	4.2	9.2
PSE210	435	190	236.5	9.5	20.9
PSE210...370	435	190	236.5	10.9	20.4

¹⁾Note: Include HMI



Ordering details

Normal start and heavy-duty start



PSE18 ... PSE105



PSE142 ... PSE170



New PSE210... PSE370



For a more precise selection, use the online softstarter selection tool available by scanning the shown QR code or using the selection tool available on: econfigure.xe.abb.com/global

Normal starts, class 10, in-line

Rated operational voltage U_g , 208...600 V. Rated control supply voltage U_c , 100...250 V AC, 50/60 Hz

IEC				UL/CSA					Type	Order code	Price
Rated operational power			Current	Rated operational power				Current			
230 V	400 V	500 V		200/208 V	220/240 V	440/480 V	550/600 V				
P_e (kW)	P_e (kW)	P_e (kW)	I_e (A)	P_e (hp)	P_e (hp)	P_e (hp)	P_e (hp)	(A)	(Eur)		
4	7.5	11	18	5	5	10	15	18	PSE18-600-70	1SFA897101R7000	
5.5	11	15	25	7.5	7.5	15	20	25	PSE25-600-70	1SFA897102R7000	
7.5	15	18.5	30	7.5	10	20	25	28	PSE30-600-70	1SFA897103R7000	
9	18.5	22	37	10	10	25	30	34	PSE37-600-70	1SFA897104R7000	
11	22	30	45	10	15	30	40	42	PSE45-600-70	1SFA897105R7000	
15	30	37	60	20	20	40	50	60	PSE60-600-70	1SFA897106R7000	
18.5	37	45	72	20	25	50	60	68	PSE72-600-70	1SFA897107R7000	
22	45	55	85	25	30	60	75	80	PSE85-600-70	1SFA897108R7000	
30	55	75	106	30	40	75	100	104	PSE105-600-70	1SFA897109R7000	
40	75	90	143	40	50	100	125	130	PSE142-600-70	1SFA897110R7000	
45	90	110	171	60	60	125	150	169	PSE170-600-70	1SFA897111R7000	
59	110	132	210	60	75	150	200	192	PSE210-600-70-1	1SFA897112R7001	
75	132	160	250	75	100	200	250	248	PSE250-600-70-1	1SFA897113R7001	
90	160	200	300	100	100	250	300	302	PSE300-600-70-1	1SFA897114R7001	
110	200	250	370	125	150	300	350	361	PSE370-600-70-1	1SFA897115R7001	

Heavy-duty start, class 30, in-line

Rated operational voltage U_g , 208...600 V. Rated control supply voltage U_c , 100...250 V AC, 50/60 Hz

3	5.5	7.5	12	3	3	7.5	10	11	PSE18-600-70	1SFA897101R7000
4	7.5	11	18	5	5	10	15	18	PSE25-600-70	1SFA897102R7000
5.5	11	15	25	7.5	7.5	15	20	25	PSE30-600-70	1SFA897103R7000
7.5	15	18.5	30	7.5	10	20	25	28	PSE37-600-70	1SFA897104R7000
9	18.5	22	37	10	10	25	30	34	PSE45-600-70	1SFA897105R7000
11	22	30	45	10	15	30	40	42	PSE60-600-70	1SFA897106R7000
15	30	37	60	20	20	40	50	60	PSE72-600-70	1SFA897107R7000
18.5	37	45	72	20	25	50	60	68	PSE85-600-70	1SFA897108R7000
22	45	55	85	25	30	60	75	80	PSE105-600-70	1SFA897109R7000
30	55	75	106	30	40	75	100	104	PSE142-600-70	1SFA897110R7000
40	75	90	143	40	50	100	125	130	PSE170-600-70	1SFA897111R7000
45	90	110	171	60	60	125	150	169	PSE210-600-70-1	1SFA897112R7001
59	110	132	210	60	75	150	200	192	PSE250-600-70-1	1SFA897113R7001
75	132	160	250	75	100	200	250	248	PSE300-600-70-1	1SFA897114R7001
90	160	200	300	100	100	250	300	302	PSE370-600-70-1	1SFA897115R7001

ABB softstarters

PSTX – The advanced range



Technical data

- Operational voltage: 208...690 VAC
- Wide rated control supply voltage: 100...250 V, 50/60 Hz
- PSTX rated operational current: 30...1250 A (inside-delta: 2160 A)
- Three-phase controlled
- Both in-line and inside-delta connection
- Coated circuit boards protecting from dust, moist and corrosive atmosphere
- Detachable keypad rated IP66 (Type 1, 4X,12)
- Graphical display with 17 languages for easy setup and operation
- Built-in bypass for energy saving and easy installation
- Built-in Modbus RTU for monitoring and control

- Support for all major communication protocols
- Analog output for measurement of current, voltage, power factor etc.

Available communication protocols:

- Built-in: Modbus RTU
- Anybus (optional): Modbus RTU, PROFIBUS DP, DeviceNet, EtherNet IP, PROFINET, Modbus TCP, BACnet, EtherCAT
- Fieldbus plug (optional): PROFIBUS, DeviceNet, Modbus RTU

Certifications and approvals:

- CE, cULus, CCC, EAC, ANCE, C-tick, ABS, DNV GL, Lloyd's Register, CCS, PRS, Class NK, KC



Complete motor protection

The PSTX offers complete motor protection in only one unit and is able to handle both load and network irregularities. PT-100, earth fault protection and over/under voltage protection along with many other functions keep your motor safer than ever.



Built-in bypass saves time and energy

When reaching full speed, the PSTX will activate its bypass. This saves energy while reducing the softstarter's heat generation. On the PSTX, the bypass is built in and verified by ABB, saving you time during installation and space in your panel.



Complete control of pumps

Time to use your processes to their full potential. The PSTX features many application enhancing features, including torque control: the most efficient way to start and stop pumps. The pump cleaning feature can reverse pump flow and clean out pipes, securing uptime of your pump system.

PSTX Dimensions and weight

Frame size	H (mm)	W (mm)	D ¹⁾ (mm)	Weight (kg)	Weight (lb)
PSTX30...105	314	150	197.5	6.10	13.45
PSTX142...170	377	199	283.3	9.60	21.16
PSTX210...370	470	258	279.1	12.70	27.99
PSTX470...570	493	361	282.15	25.00	55,12
PSTX720...840	493	435	366.5	46.20	101.85
PSTX1050	515	435	366.5	64.20	141.64
PSTX1250	565	435	366.5	64.70	142.64

¹⁾Note: Include HMI



Ordering details

Normal start, class 10, in-line



For a more precise selection, use the online softstarter selection tool available by scanning the shown QR code or using the selection tool available on: econfigure.xe.abb.com/global



PSTX30 ... PSTX105 PSTX142 ... PSTX170 PSTX210 ... PSTX370 PSTX470 ... PSTX570 PSTX720 ... PSTX840 PSTX1050 ... PSTX1250

Normal start, class 10, in-line. For more PSTX view softstarter main catalog Link.
 Rated operational voltage U_e , 208...600 V, Rated control supply voltage U_c , 100...250 V AC, 50/60 Hz









IEC			UL/CSA					Type	Order code	Price
Rated operational power		Current	Rated operational power				Current			
400 V	500 V	690 V	200/208 V	220/240 V	440/480 V	550/600 V	FLA			
P_e (kW)	P_e (kW)	P_e (kW)	P_e (hp)	P_e (hp)	P_e (hp)	P_e (hp)	(A)		(Eur)	
15	18.5	-	30	7.5	10	20	25	28	PSTX30-600-70	1SFA898103R7000
18.5	22	-	37	10	10	25	30	34	PSTX37-600-70	1SFA898104R7000
22	25	-	45	10	15	30	40	42	PSTX45-600-70	1SFA898105R7000
30	37	-	60	20	20	40	50	60	PSTX60-600-70	1SFA898106R7000
37	45	-	72	20	25	50	60	68	PSTX72-600-70	1SFA898107R7000
45	55	-	85	25	30	60	75	80	PSTX85-600-70	1SFA898108R7000
55	75	-	106	30	40	75	100	104	PSTX105-600-70	1SFA898109R7000
75	90	-	143	40	50	100	125	130	PSTX142-600-70	1SFA898110R7000
90	110	-	171	50	60	125	150	169	PSTX170-600-70	1SFA898111R7000
110	132	-	210	60	75	150	200	192	PSTX210-600-70	1SFA898112R7000
132	160	-	250	75	100	200	250	248	PSTX250-600-70	1SFA898113R7000
160	200	-	300	100	100	250	300	302	PSTX300-600-70	1SFA898114R7000
200	257	-	370	125	150	300	350	361	PSTX370-600-70	1SFA898115R7000
250	315	-	470	150	200	400	500	480	PSTX470-600-70	1SFA898116R7000
315	400	-	570	200	200	500	600	590	PSTX570-600-70	1SFA898117R7000
400	500	-	720	250	300	600	700	720	PSTX720-600-70	1SFA898118R7000
450	600	-	840	300	350	700	800	840	PSTX840-600-70	1SFA898119R7000
560	730	-	1050	400	450	900	1000	1062	PSTX1050-600-70	1SFA898120R7000
710	880	-	1250	400	500	1000	1200	1250	PSTX1250-600-70	1SFA898121R7000

Rated operational voltage U_e , 208...690 V, Rated control supply voltage U_c , 100...250 V AC, 50/60 Hz

15	18.5	25	30	7.5	10	20	25	28	PSTX30-690-70	1SFA898203R7000
18.5	22	30	37	10	10	25	30	34	PSTX37-690-70	1SFA898204R7000
22	25	37	45	10	15	30	40	42	PSTX45-690-70	1SFA898205R7000
30	37	55	60	20	20	40	50	60	PSTX60-690-70	1SFA898206R7000
37	45	59	72	20	25	50	60	68	PSTX72-690-70	1SFA898207R7000
45	55	75	85	25	30	60	75	80	PSTX85-690-70	1SFA898208R7000
55	75	90	106	30	40	75	100	104	PSTX105-690-70	1SFA898209R7000
75	90	132	143	40	50	100	125	130	PSTX142-690-70	1SFA898210R7000
90	110	160	171	50	60	125	150	169	PSTX170-690-70	1SFA898211R7000
110	132	184	210	60	75	150	200	192	PSTX210-690-70	1SFA898212R7000
132	160	220	250	75	100	200	250	248	PSTX250-690-70	1SFA898213R7000
160	200	257	300	100	100	250	300	302	PSTX300-690-70	1SFA898214R7000
200	257	355	370	125	150	300	350	361	PSTX370-690-70	1SFA898215R7000
250	315	450	470	150	200	400	500	480	PSTX470-690-70	1SFA898216R7000
315	400	560	570	200	200	500	600	590	PSTX570-690-70	1SFA898217R7000
400	500	710	720	250	300	600	700	720	PSTX720-690-70	1SFA898218R7000
450	600	800	840	300	350	700	800	840	PSTX840-690-70	1SFA898219R7000
560	730	1000	1050	400	450	900	1000	1062	PSTX1050-690-70	1SFA898220R7000
710	880	1200	1250	400	500	1000	1200	1250	PSTX1250-690-70	1SFA898221R7000









Accessories

PSR softstarter

	For softstarter type	Type	Order code	Pkg qty	Weight (1 pce)		Price (Eur)
					(kg)	(lb)	
Connection kit							
	PSR3...16	PSR16-MS116	1SFA896211R1001	1	0.022	(0.049)	
	PSR25...30	PSR30-MS132	1SFA896212R1001	1	0.040	(0.088)	
	PSR60...105	PSR105-MS495	1SAM501903R1001	1	0.034	(0.075)	
	PSR37...45	PSR45-MS165	1SFA896216R1001	1	0.050	(0.110)	
	PSR60...72	PSR60-MS165	1SFA896215R1001	1	0.050	(0.110)	
Fan							
	PSR3 ... PSR45	PSR-FAN3-45A	1SFA896311R1001	1	0.010	(0.022)	
	PSR60 ... PSR105	PSR-FAN60-105A	1SFA896313R1001	1	0.013	(0.029)	
Terminal enlargements							
	PSR60 ... PSR105 Wire range mm ² 1 x 10...50 mm ² , 2 x 10...25 mm ²	PSLW-72	1SFA899002R1072	1	0.150	(0.033)	
FieldBusPlug connection accessory							
	PSR3 ... PSR105	PS-FBPA	1SFA896312R1002	1	0.060	(0.132)	





Accessories





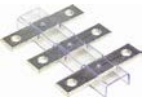
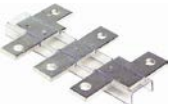



PSE softstarter

	For softstarter type	Wire range (mm²)	Tightening torque max. (Nm)	Type	Order code	Pkg qty	Weight (1 pce)		Price (Eur)
							(kg)	(lb)	
Cable connectors for Cu cables									
	PSE142 ... PSE170	6...120	14	-	1SDA066917R1	3	0.113	(0.249)	
	PSE142 ... PSE170	2 x (50...120)	16	LZ185-2C/120	1SFN074709R1000	3	0.100	(0.220)	
	PSE210 ... PSE370	16...300	25	-	1SDA055016R1	3	0.133	(0.293)	
Cable connectors for Al and Cu cables									
	PSE142 ... PSE170	95...185	31	-	1SDA054988R1	3	0.078	(0.172)	
	PSE210 ... PSE370	185...240	43	-	1SDA055020R1	3	0.133	(0.293)	
	For softstarter type	Dimensions hole ø (mm²)	bar (mm²)	Type	Order code	Pkg qty	Weight (1 pce)		Price (Eur)
Terminal enlargements									
	PSE18 ... PSE105	6.5	15 x 3	LW110	1SFN074307R1000	1	0.100	(0.220)	
	PSE142 ... PSE170	10.5	17.5 x 5	LW185	1SFN074707R1000	1	0.450	(0.992)	
	PSE210 ... PSE370	10.5	20 x 5	LW300	1SFN075107R1000	1	1.230	(2.712)	
	For softstarter type	Req. qty	Type	Order code	Pkg qty	Weight (1 pce)		Price (Eur)	
Terminal shrouds									
	PSE142 ... PSE170, short for use with cable clamps	2	LT185-AC	1SFN124701R1000	2	0.050	(0.110)		
	PSE210 ... PSE370, short for use with cable clamps	2	LT300-AC	1SFN125101R1000	2	0.070	(0.154)		
	PSE142 ... PSE170, long for use with compression lugs	2	LT185-AL	1SFN124703R1000	2	0.220	(0.485)		
	PSE210 ... PSE370, long for use with compression lugs	2	LT300-AL	1SFN125103R1000	2	0.280	(0.617)		
	For softstarter type	Req. qty	Type	Order code	Pkg qty	Weight (1 pce)		Price (Eur)	
External keypad including a 3 m cable									
	PSE18 ... PSE370	PSEEK	1SFA897100R1001	1	0.198	(0.437)			
USB cable for Service Engineer Tool									
	PSE18 ... PSE370	PSECA	1SFA897201R1001	1	0.130	(0.287)			
FieldBusPlug connection accessory									
	PSE18 ... PSE370	PS-FBPA	1SFA896312R1002	1	0.060	(0.132)			
Terminal Extensions retrofit kit									
	PSE210 ... PSE370-1	LXR370	1SFA899222R1003	1	0.450	(0.992)			
Modbus adapter									
	PSE18...PSE370-1	PS-MBIA	1SFA899300R1020	1	0.011	(0.024)			

Accessories

PSTX softstarter

	For softstarter type	Wire range (mm ²)	Tightening torque max. (Nm)	Type	Order code	Pkg qty	Weight (1 pce)		Price (Eur)
							(kg)	(lb)	
Cable connectors for Cu cables									
	PSTX142 ... PSTX170	6-120	8	-	1SDA066917R1	3	0.113	(0.249)	
	PSTX142 ... PSTX170	2 x (50-95)	16	LZ185-2C/120	1SFN074709R1000	3	0.300	(0.661)	
	PSTX210 ... PSTX370	16-240	25	-	1SDA055016R1	3	0.133	(0.293)	
	PSTX210 ... PSTX370	2 x (70-185)	22	OZXB4	1SCA022194R0890	3	0.570	(1.257)	
	PSTX470 ... PSTX570	2 x (120-240)	35	-	1SDA013922R1	3	0.570	(1.257)	
	PSTX570 ... PSTX1050	3 x (70-185)	45	-	1SDA013956R1	3	0.570	(1.257)	
Cable connectors for Al and Cu cables									
	PSTX142 ... PSTX170	95-185	31	-	1SDA054988R1	3	0.078	(0.172)	
	PSTX210 ... PSTX370	185-240	43	-	1SDA055020R1	3	0.133	(0.293)	
	PSTX470 ... PSTX1050	2 x (120-240)	31	-	1SDA023380R1	3	0.110	(0.243)	
	For softstarter type	Dimensions hole ø (mm²)	bar (mm²)	Type	Order code	Pkg qty	Weight (1 pce)		Price (Eur)
							(kg)	(lb)	
Terminal extensions									
	PSTX142 ... PSTX170	8.5	17.5 x 5	LX205	1SFN074810R1000	1	0.250	(5.551)	
	PSTX210 ... PSTX370	10.5	20 x 5	LX370	1SFN075410R1000	1	0.350	(0.772)	
	PSTX470 ... PSTX570	10.5	25 x 5	LX460	1SFN075710R1000	1	0.500	(1.102)	
	PSTX720 ... PSTX840	13	40 x 6	LX750	1SFN076110R1003	1	0.850	(1.874)	
Terminal enlargements									
	PSTX30 ... PSTX105	6.5	15 x 3	LW110	1SFN074307R1000	1	0.100	(0.220)	
	PSTX142 ... PSTX170	10.5	17.5 x 5	LW205	1SFN074807R1000	1	0.250	(5.551)	
	PSTX210 ... PSTX370	10.5	20 x 5	LW370	1SFN075407R1000	1	0.450	(0.992)	
	PSTX470 ... PSTX570	10.5	25 x 5	LW460	1SFN075707R1000	1	0.730	(1.609)	
	PSTX720 ... PSTX840	13	40 x 6	LW750	1SFN076107R1000	1	1.230	(2.712)	
	For softstarter type	Req. qty		Type	Order code	Pkg qty	Weight (1 pce)		Price (Eur)
							(kg)	(lb)	
Terminal shrouds									
	PSTX142 ... PSTX170, short for use with cable clamps	2		LT205-30C	1SFN124801R1000	2	0,050	(0.110)	
	PSTX210 ... PSTX370, short for use with cable clamps	2		LT370-30C	1SFN125401R1000	2	0.035	(0.077)	
	PSTX142 ... PSTX170, long for use with compression lugs	2		LT205-30L	1SFN124803R1000	2	0.220	(0.485)	
	PSTX210 ... PSTX370, long for use with compression lugs	2		LT370-30L	1SFN125403R1000	2	0.280	(0.617)	
	PSTX210 ... PSTX370, long and deep for use with extending cable clamps, ATK300/2 and OZXB4	2		LT370-30D	1SFN125406R1000	2	0.150	(0.331)	
	PSTX470 ... PSTX570 , short for use with cable clamps	2		LT460-AC	1SFN125701R1000	2	0.100	(0.220)	
	PSTX720 ... PSTX840, short for use with cable clamps	2		LT750-AC	1SFN126101R1000	2	0.120	(0.265)	
	PSTX470 ... PSTX570, long for use with compression lugs	2		LT460-AL	1SFN125703R1000	2	0.800	(1.764)	
	PSTX720 ... PSTX840, long for use with compression lugs	2		LT750-AL	1SFN126103R1000	2	0.825	(1.819)	

	For softstarter type	Type	Order code	Pkg qty	Weight (1 pce)		Price (Eur)	
					(kg)	(lb)		
Anybus connection accessory for communication protocol suitable for PSTX30 ... PSTX1250								
	Profibus	AB-PROFIBUS-1	1SFA899300R1001	1	0.028	0.062		
	DeviceNet	AB-DEVICENET-1	1SFA899300R1002	1	0.028	0.062		
	Modbus-RTU	AB-MODBUS-RTU-1	1SFA899300R1003	1	0.028	0.062		
	BACnet IP	AB-BACNET-IP-2	1SFA899300R1004	1	0.028	0.062		
	EtherNet/IP (2-port)	AB-ETHERNET-IP-2	1SFA899300R1006	1	0.028	0.062		
	Modbus/TCP (2-port)	AB-MODBUS-TCP-2	1SFA899300R1008	1	0.028	0.062		
	Profinet (2-port)	AB-PROFINET-IO-2	1SFA899300R1010	1	0.028	0.062		
	BACnet MS/TP	AB-BACNET-MSTP-1	1SFA899300R1011	1	0.028	0.062		
	EtherCAT	AB-ETHERCAT-IP-2	1SFA899300R1012	1	0.028	0.062		
FieldBusPlug connection accessory, ABB's FieldBusPlug suitable for all sizes, see latest softstarter catalog.								
	PSTX30 ... PSTX1250	PS-FBPA	1SFA896312R1002	1	0.060	(0.132)		
	PSTX30 ... PSTX1250	PS-FBPK	1SFA899320R1002	1	0.150	(0.331)		
I/O module, 24 V DC digital input								
	PSTX30 ... PSTX1250	DX111-FBP.0	1SAJ611000R0101	1	0.220	(0.485)		
Terminal kit								
	Terminal kit	Req. qty	Type	Order code	Pkg qty	Weight (1 pce)		Price
						(kg)	(lb)	(Eur)
Terminal nut washer								
	PSTX142 ... PSTX170	1	PSLE-185	1SFA899221R1002	1	0.200	(0.441)	
	PSTX210 ... PSTX370	1	PSLE-300	1SFA899221R1003	1	0.300	(0.661)	
	PSTX470 ... PSTX570	1	PSLE-460	1SFA899221R1004	1	0.600	(1.323)	
	PSTX720 ... PSTX840	1	PSLE-750	1SFA899221R1005	1	0.750	(1.653)	

Introducing the most extensive drives and softstarters portfolio in the world

ABB low voltage AC drives

The ABB low voltage AC drives product range, from 0.18 to 5600 kW, is the widest available from any manufacturer. These drives are the global benchmark that signifies reliability, simplicity, flexibility and ingenuity throughout the entire life cycle of the drive.

Several ABB drives feature calculators that provide energy consumption data. This information can be used to further analyze and tune a process for even greater energy savings.

The portfolio is supported by a selection of PC tools, fieldbus and communication options.

ABB micro drives

ABB micro drives are suitable for many low power applications such as pumps, fans and conveyors. The focus in our design has been the easy integration into machines, which provides flexible mounting alternatives and straightforward commissioning.

ABB general purpose drives

ABB general purpose drives are ideal in those situations where there is a need for simplicity to install, commission and use. They are designed to control a wide range of standard drives applications, including pump, fan and constant torque use, such as conveyors.



ABB machinery drives

ABB machinery drives can be configured to meet the precise needs of industries and order-based configuration is an integral part of the offering. Covering a wide power and voltage range with standard and optional features, the drives are readily programmable, making their adaptation to different applications easy.

ABB motion control products

ABB offers an extensive range of complete machine control solutions for diverse industrial applications such as labeling, packaging, bottling, pick and place, laser cutting/trimming, stacking, cut-to-length, flying shear, web feeders and high speed rotary wrappers.

ABB industrial drives

The ABB industrial drive portfolio is designed for heavy industrial applications such as those found in pulp and paper, metals, mining, cement, power, chemical, oil and gas, water and wastewater and food and beverage. Drives adapted and approved for use in the marine environment are also included within this portfolio.

Industry specific drives

Our industry specific ABB drives provide our customers with dedicated drive solutions for AC motor control used in industries such as HVAC and water and wastewater. Working closely with these industries, we have developed targeted functionality to help you improve your overall operating performance while also helping to reduce energy use. Built-in application macros in the drives help you easily set up and tailor processes.

ABB DC drives

ABB's DC drive portfolio, from 9 to 18000 kW, provides the highest power-to-size ratio on the market. The drives are designed for most industries including metals, cement, mining, pulp and paper, printing, food and beverage, wire manufacturing, test rigs, ski lift and cranes. ABB DC drives are available as complete cabinets, modules for cabinet assembly, and as retrofit kits. With built-in field exciters and integrated PLC's, they are the best DC drives choice for all new and retrofit applications.

ABB softstarters

A softstarter is the optimal compromise between a direct on-line or star delta starter and an advanced variable speed drive in many motor applications. Like direct on-line or star delta starters, it is used in full-speed applications. Like variable speed drives, it can perform soft starts and stops.

To find more information please visit:

abb.com/drives
new.abb.com/low-voltage/products/softstarters



We keep your world turning

Whatever your needs are, we offer the most extensive service offering for drives, motors and generators from spare parts and technical support to cloud-based condition monitoring solutions to keep your equipment running.

The global ABB service units complemented by external Value Providers form a service network on your doorstep. Maximize performance, uptime and efficiency throughout the life cycle of your assets.

With you every step of the way

Even before you buy a generator, drive, motor, bearing or softstarter, ABB's experts are on hand to offer technical advice from dimensioning through to potential energy saving.

When you've decided on the right product, ABB and its global network of Value Providers can help with installation and commissioning. They are also on hand to support you throughout the operation and maintenance phases of the products life cycle, providing maintenance programs tailored to your facility's needs.

ABB will ensure you are aware of any service opportunities. If you've registered your drives and motors with ABB, then its engineers will proactively contact you advising on your most effective service options. All of which helps maximize performance, uptime and efficiency throughout the lifetime of your powertrain.



Replacements
Fast and efficient replacement services to minimize production downtime.



End-of-life services
Responsible dismantling, recycling and reusing of products, according to local laws and industrial standards.



Maintenance
Systematic and organized maintenance and support over the life cycle of your assets.





Advanced services
Gain the unique ABB Ability™ digital advantage through data collection and analytics with advanced services.



Extensions, upgrades & retrofits
Up-to-date systems and devices with the best possible performance level.



Engineering & consulting
Ways to identify and improve the reliability, usability, maintainability and safety of your production processes.



Spares & consumables
Authentic, high-quality ABB spares and consumables with quick delivery.



Technical support & repairs
Quick and accurate response during emergencies and efficient support during planned production breaks.



Installation & commissioning
Highly-trained and reliable installation and commissioning experts at your service.



Training
Comprehensive and professional training either at ABB premises or your own.



Agreements
Comprehensive bundling of relevant services into one contract to suit your needs.

Global service network 24/7

—
“I need operational excellence, rapid response, improved performance and life cycle management.”

A lifetime of peak performance

You're in control of every phase of the life of your drive. At the heart of drive services is a four-phase product life cycle management model. This model defines the services recommended and available throughout your drive's lifespan.

Now it's easy for you to see the exact service and maintenance available for your drives.

ABB drives life cycle phases explained:



Full range of life cycle services and support

Limited range of life cycle services and support

Replacement and end-of-life services

Product	Product is in active sales and manufacturing phase.	Serial production has ceased. Product may be available for plant extensions, as a spare part or for installed base renewal.	Product is no longer available.	Product is no longer available.
	Services	Full range of life cycle services is available. Product enhancements may be available through upgrade and retrofit solutions.	Limited range of life cycle services is available. Spare parts availability is limited to available stock.	Replacement and end-of-life services are available.

Keeping you informed

We notify you every step of the way using life cycle status statements and announcements.

The benefit for you is clear information about the status of your drives and the exact services available. It helps you plan the preferred service actions ahead of time and make sure that continuous support is always available.

Step 1

Life Cycle Status Announcement

Provides early information about the upcoming life cycle phase change and how it affects the availability of services.

Step 2

Life Cycle Status Statement

Provides information about the drive's current life cycle status, the availability of product and services, the life cycle plan, and recommended actions.

—
For more information, please contact
your local ABB representative or visit

new.abb.com/drives
new.abb.com/drivespartners
new.abb.com/drives/softstarters

