

2JW1024

CELLULAR / LTE Connector Mount

Key Features

CELLULAR / LTE

- 698-960 MHz
- 1710-2170 MHz
- 2500-2700 MHz

Connector Mount

Low Profile

High Efficiency

Ground Plane Dependent

Dimensions Ø 10 × 71 mm



1. Antenna and electrical specifications

Parameters	CELLULAR / LTE Antenna		
Standards	2G,3G and 4G		
Band (MHz)	700/850/900	1700/1800/1900/2100	2600
Frequency (MHz)	698-960	1710-2170	2500-2700
Return Loss (dB)	~-5.9	~-11.7	~-14.4
VSWR	~3.1:1	~1.7:1	~1.5:1
Efficiency (%)	~58	~67	~74
Peak Gain (dBi)	~-0.1	~-2.9	~-4.6
Average Gain (dB)	~-2.3	~-1.7	~-1.3
Impedance (Ohm)	50		
Polarisation	Linear		
Radiation Pattern	Omni-Directional		
Max. Input Power (W)	10		
Connector Type	SMA-Male Standard		

Antenna Measurement Conditions:

Mounted on Ground Plane of 115 × 45 mm

Measured in Certified CTIA 3D Anechoic Chamber

2. Mechanical and environmental specifications

Specifications	2JW1024
Mounting Type	Connector Mount
Dimensions (mm)	Ø 10 × 71
Radome Type	POM
Radome Color	Black
Operating Temperature (C)	-40 to +85
Storage Temperature (C)	-40 to +85
Substance Compliance	RoHS

3. Antenna parameters

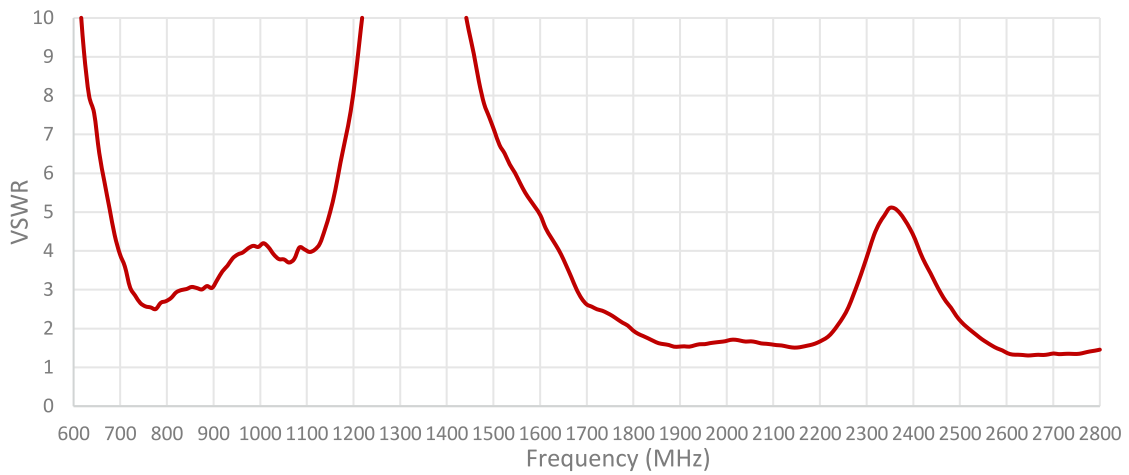
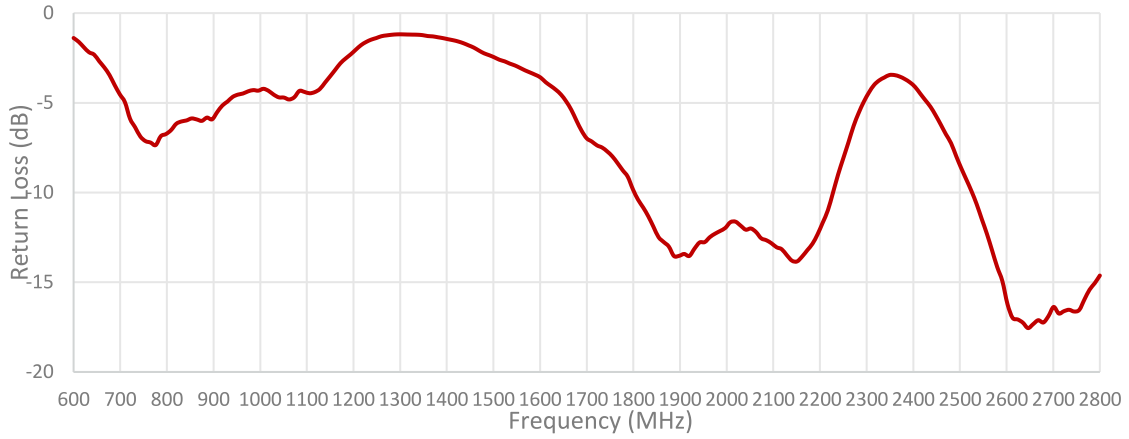

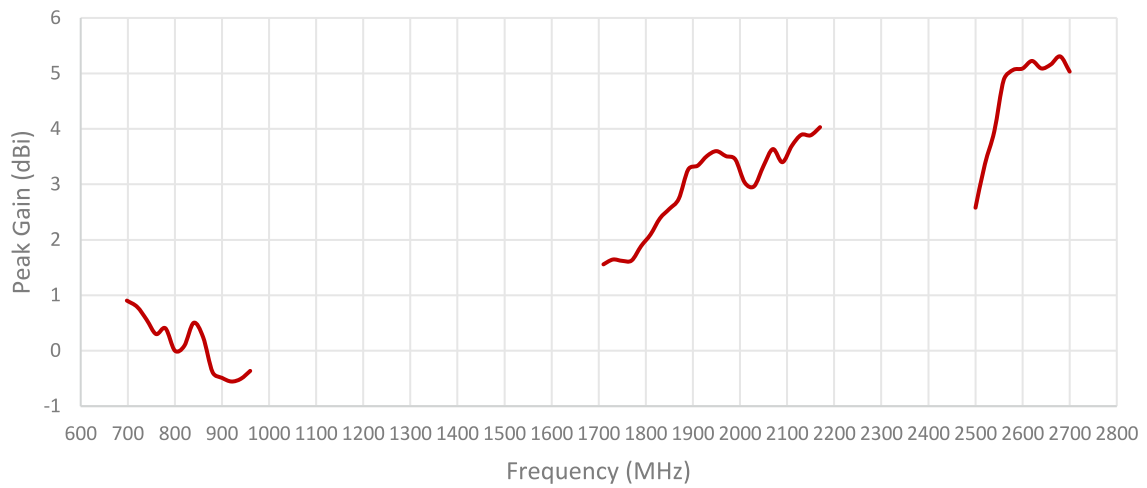
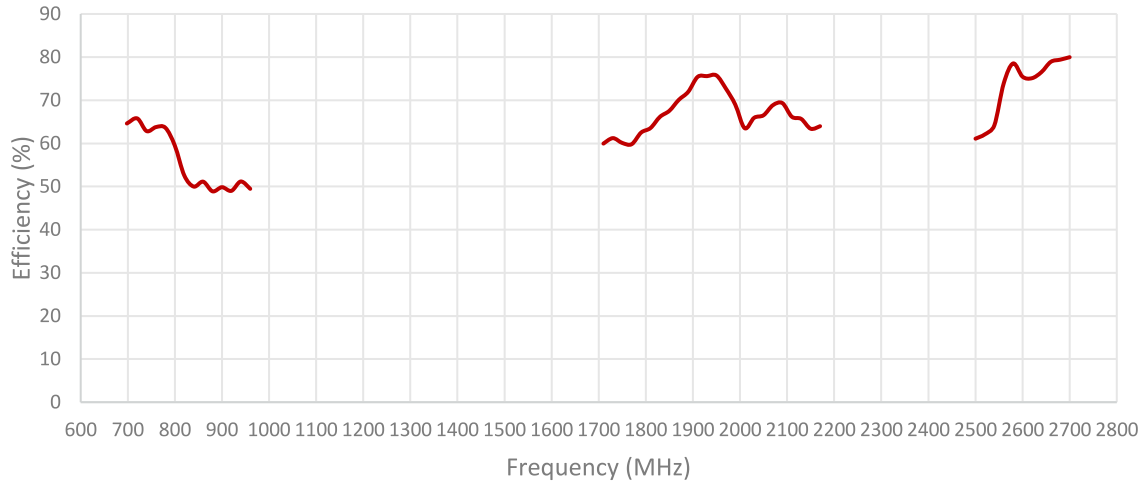

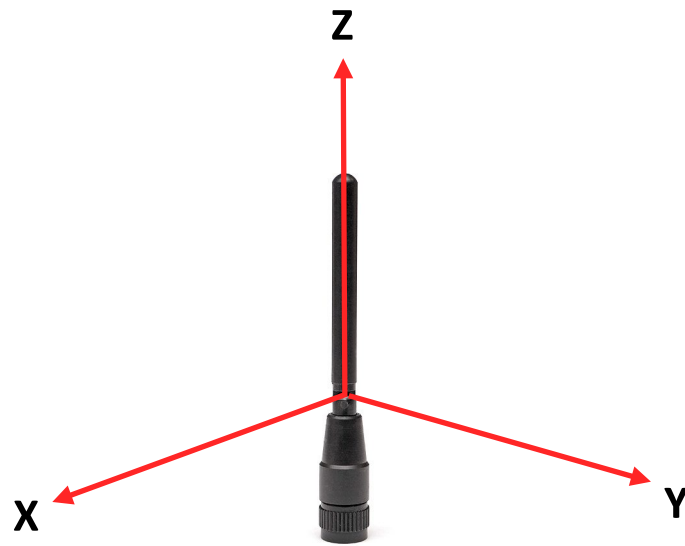
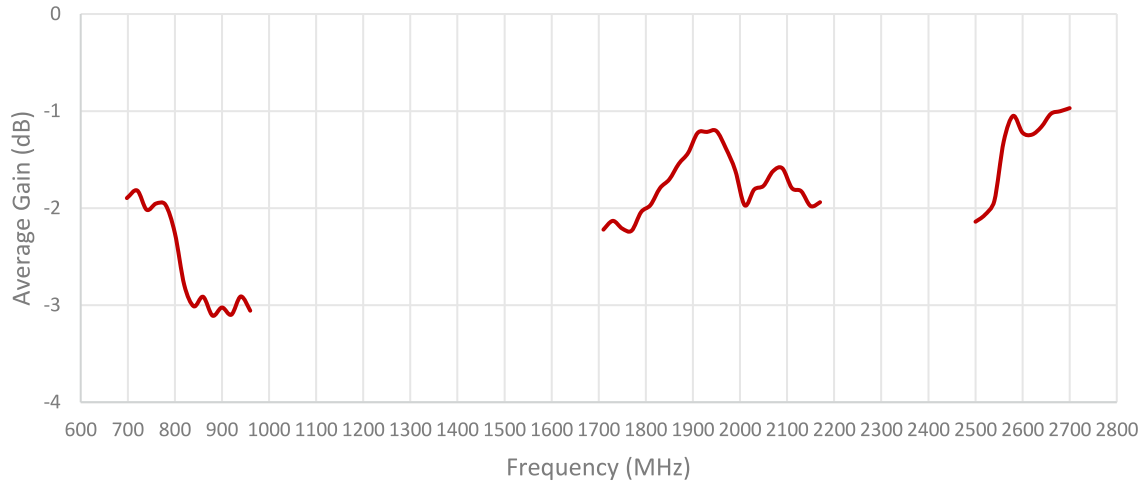

Radiation pattern reference

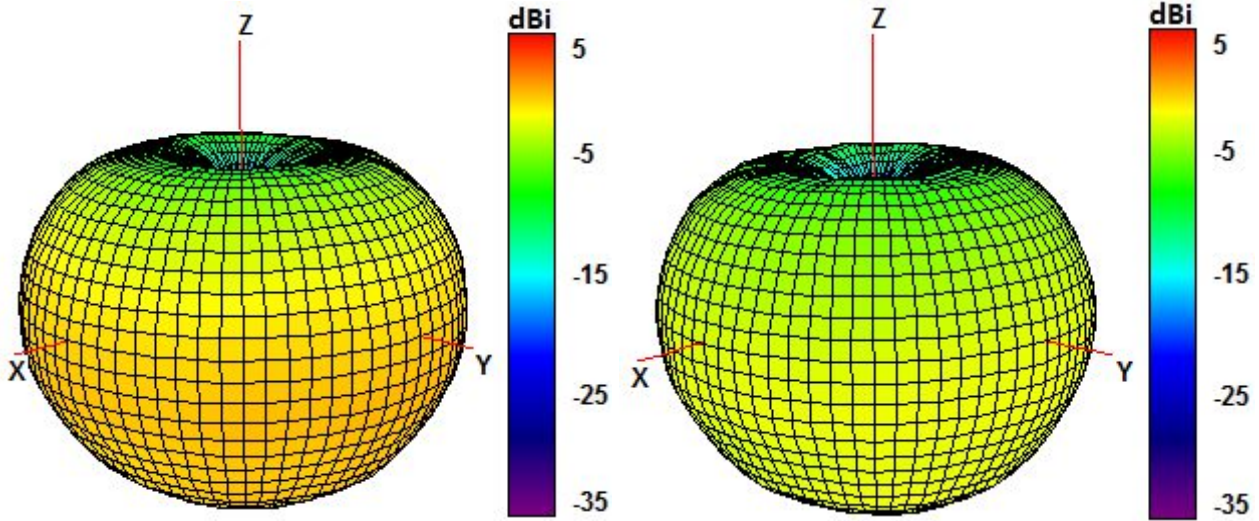

750 and 850 MHz Radiation pattern

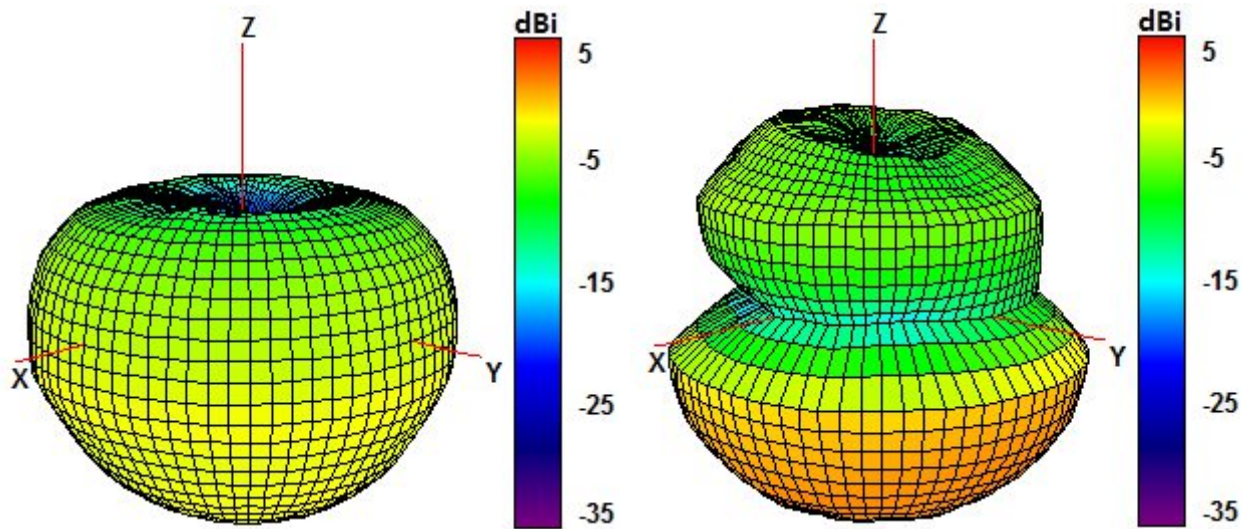

940 and 1750 MHz Radiation pattern

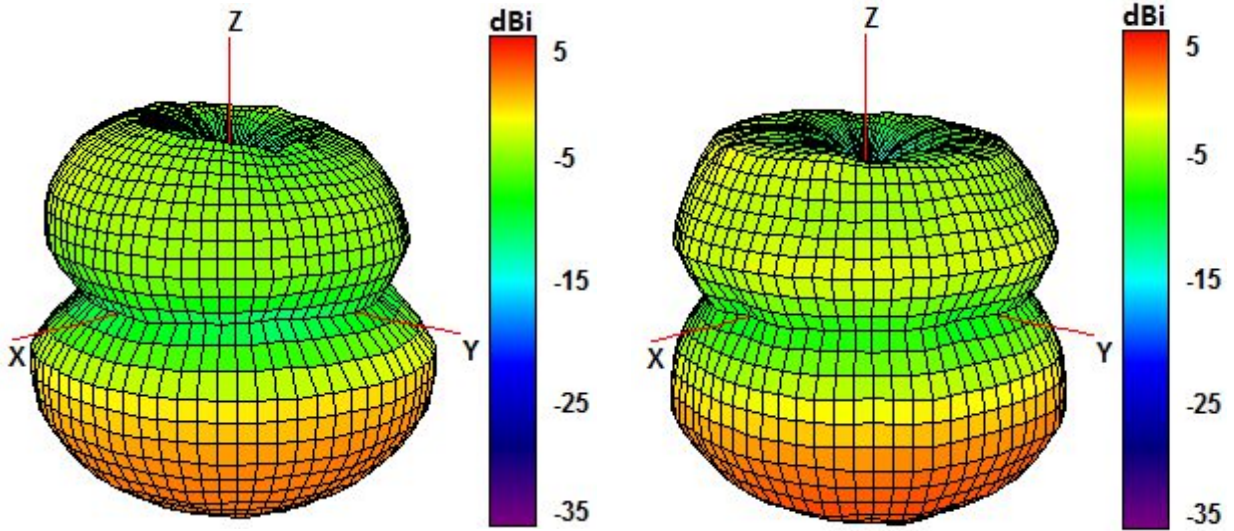

1850 and 1950 MHz Radiation pattern

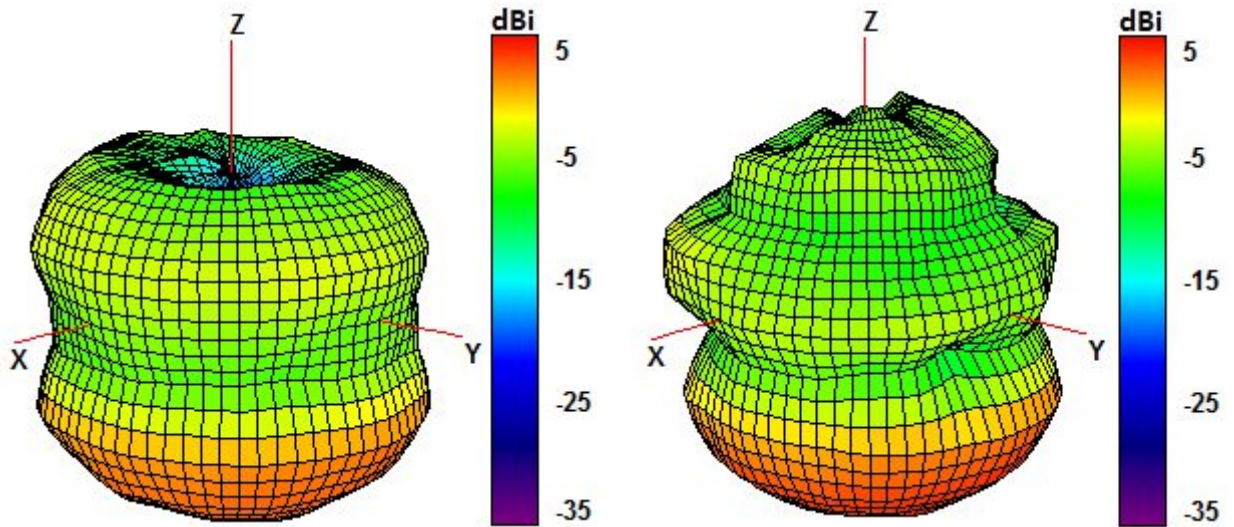

2100 and 2600 MHz Radiation pattern

4. Antenna drawings

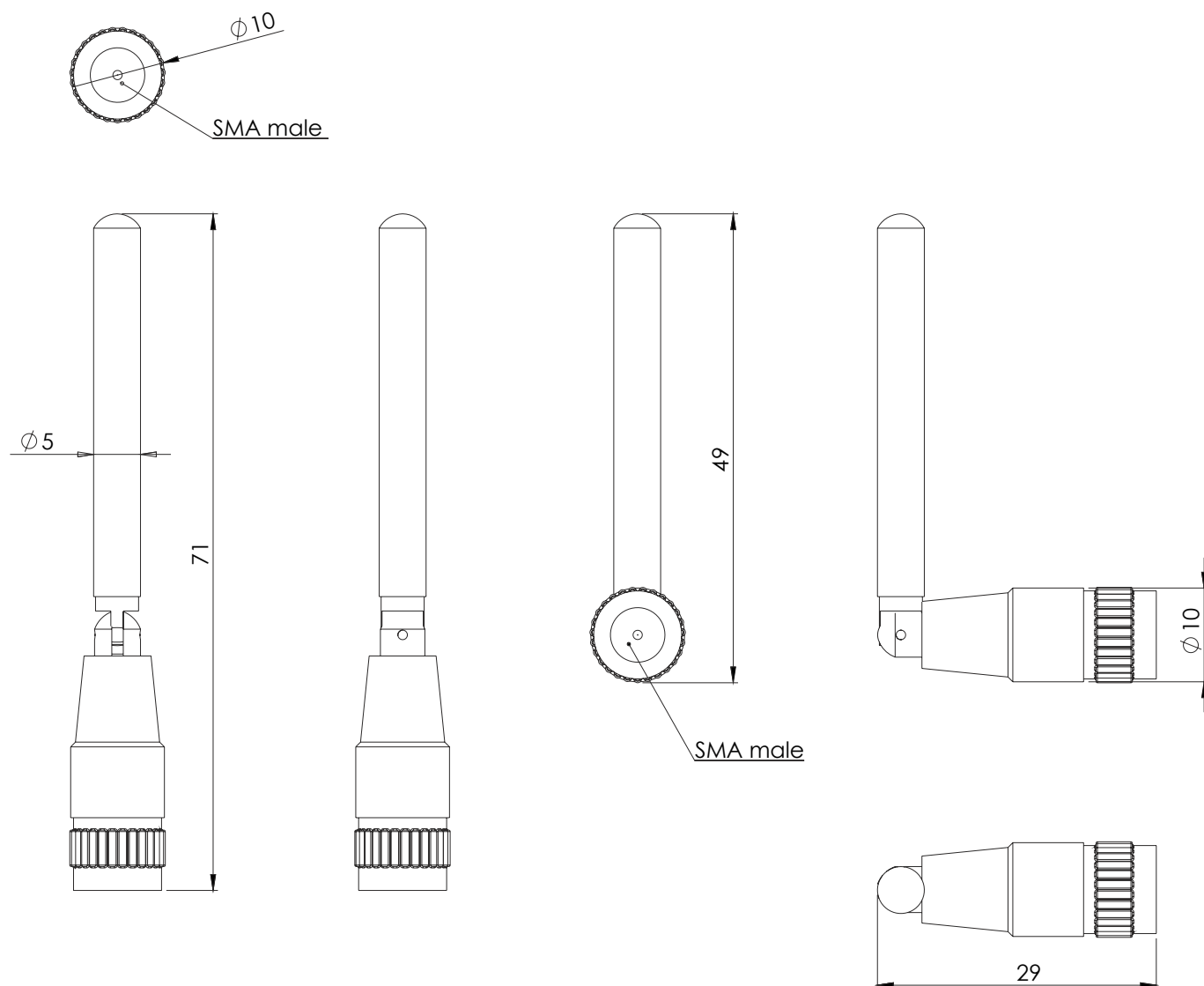

5. Antenna Images

