

2JW0315-868-C675B

868 MHz ISM Connector Mount

Key Features

- 868 MHz ISM
- 863-870 MHz
- Connector Mount
- Ground Plane Independent
- Hinged Connector
- Dimensions 113 × Ø 10 mm



1. Antenna and electrical specifications

Parameters	868 MHz ISM Antenna
Standards	ZigBee, ISM, SIGFOX, LoRa
Band (MHz)	868 MHz
Frequency (MHz)	863-870
Return Loss (dB)	~-11.0
VSWR	~1.8:1
Efficiency (%)	~51.2
Peak Gain (dBi)	~1.4
Average Gain (dB)	~-2.9
Impedance (Ohm)	50
Polarisation	Linear
Radiation Pattern	Omni-Directional
Max. Input Power (W)	25
Connector Type	SMA-Male Standard

Antenna Measurement Conditions:

Free Space

Measured in Certified CTIA 3D Anechoic Chamber

2. Mechanical and environmental specifications

Specifications	2JW0315-868-C675B
Mounting Type	Connector Mount
Dimensions (mm)	113 × Ø 10
Radome	ABS UV Stable
Radome color	Black
Connector Feature	Hinged
Operating Temperature (C)	-40 to +85
Storage Temperature (C)	-40 to +85
Substance Compliance	RoHS

3. Antenna parameters

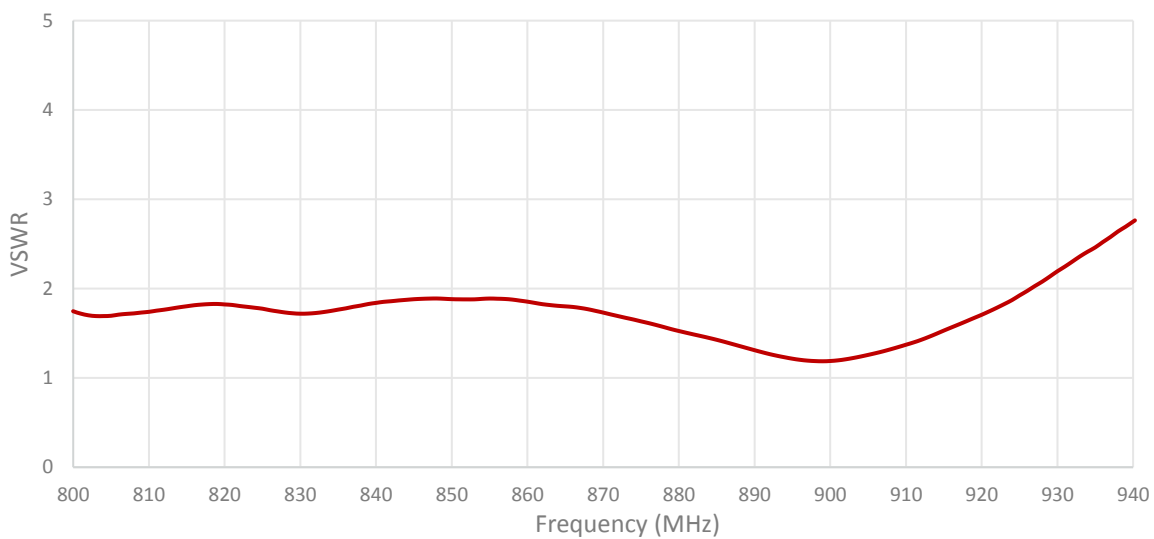
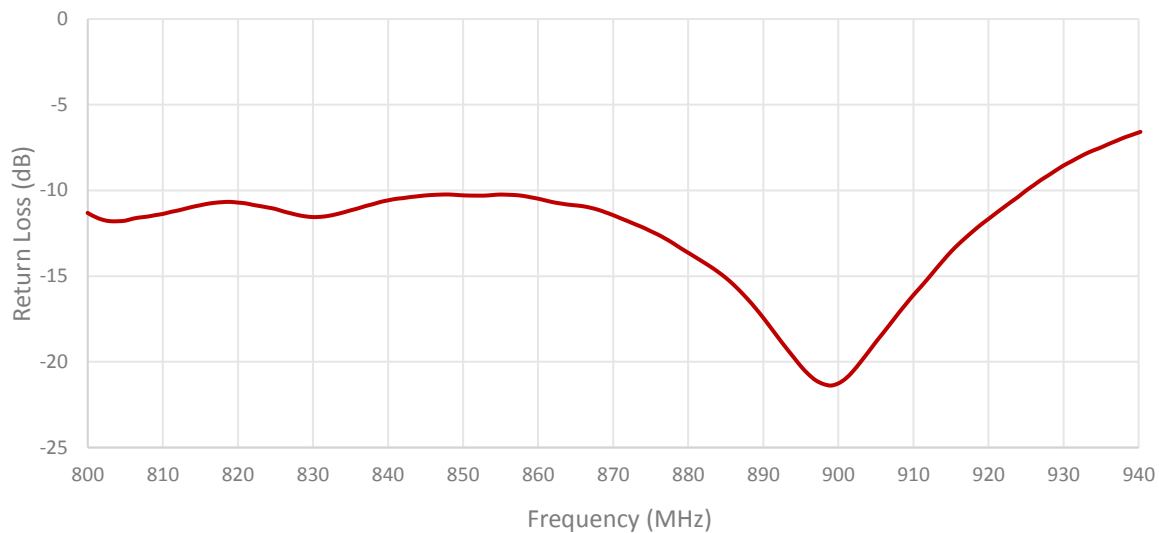

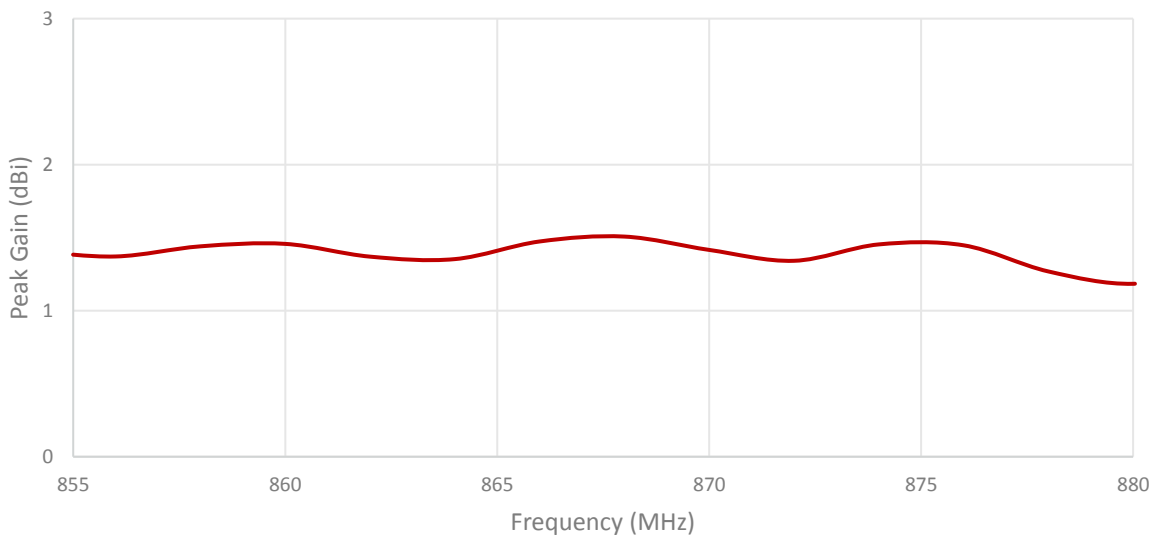
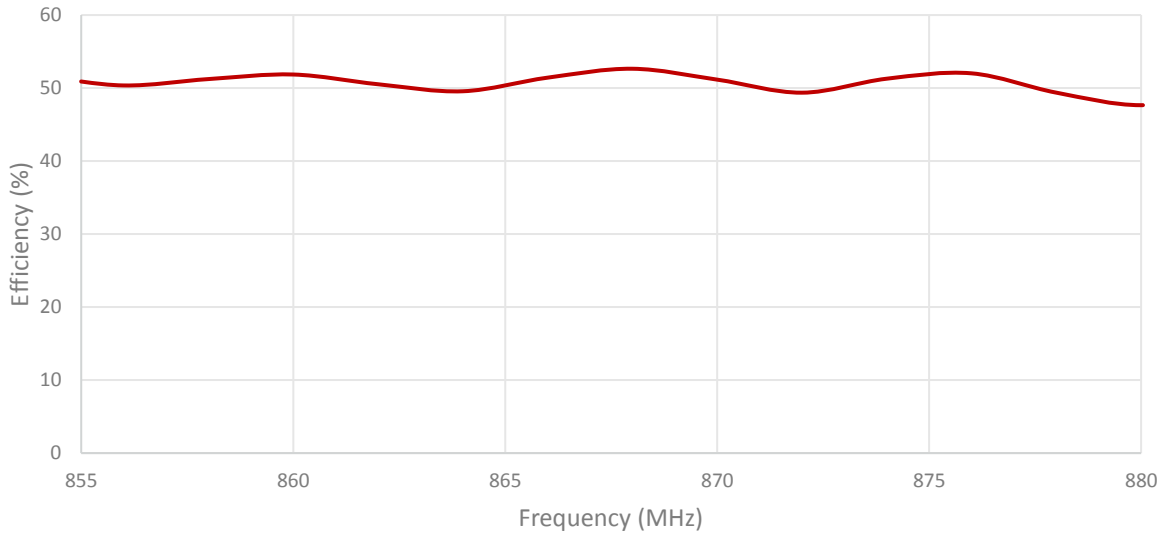

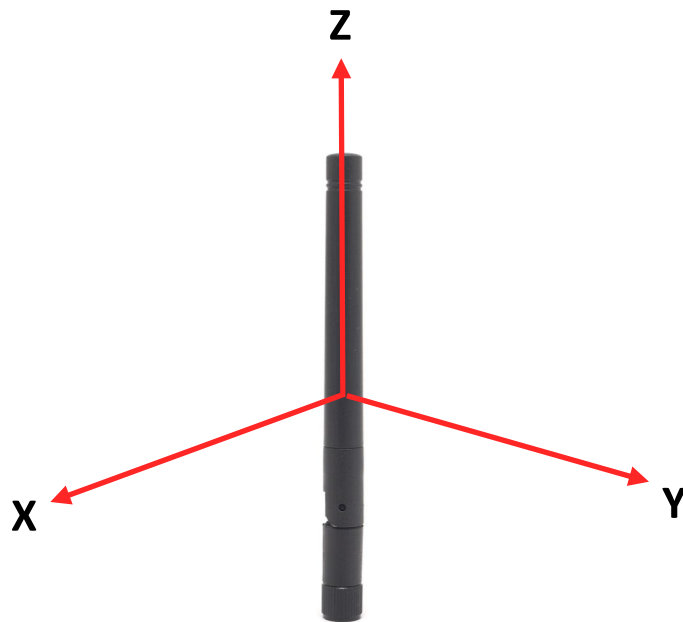
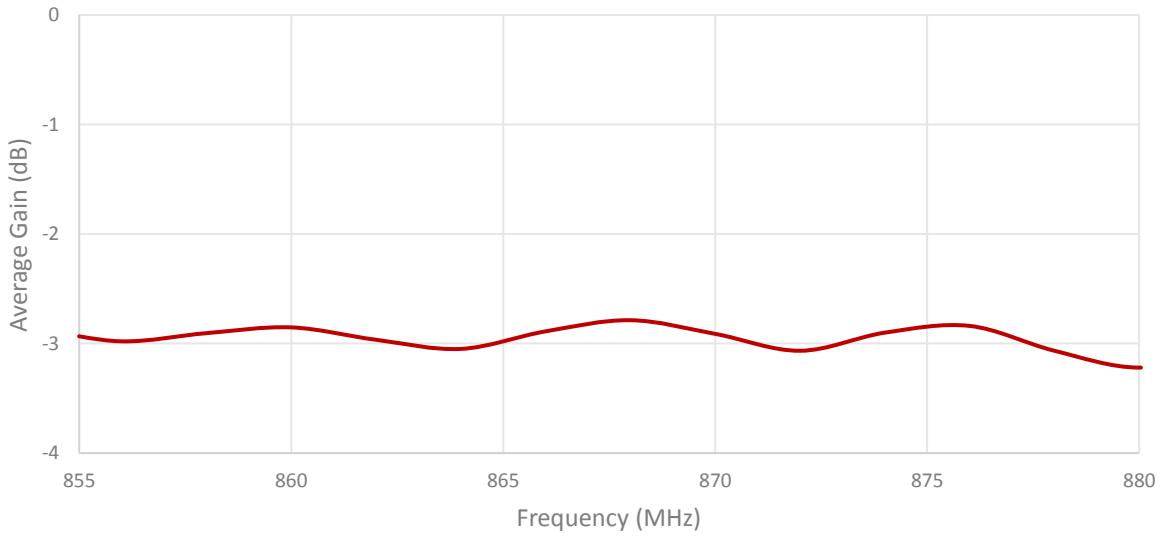

Radiation pattern reference

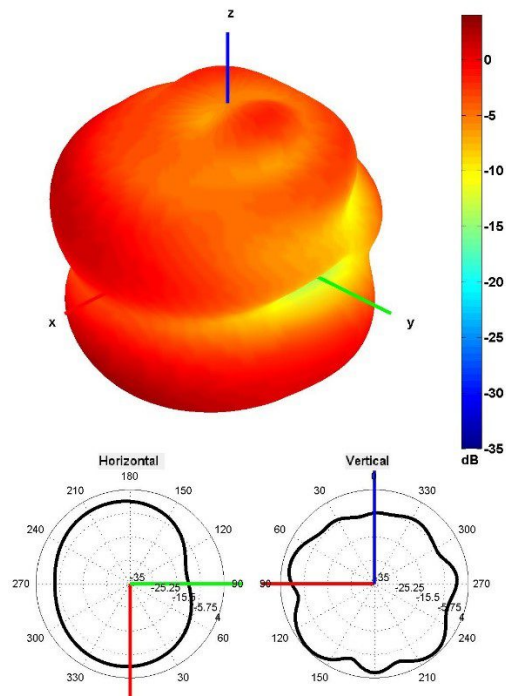

868 MHz Radiation pattern

4. Antenna drawings

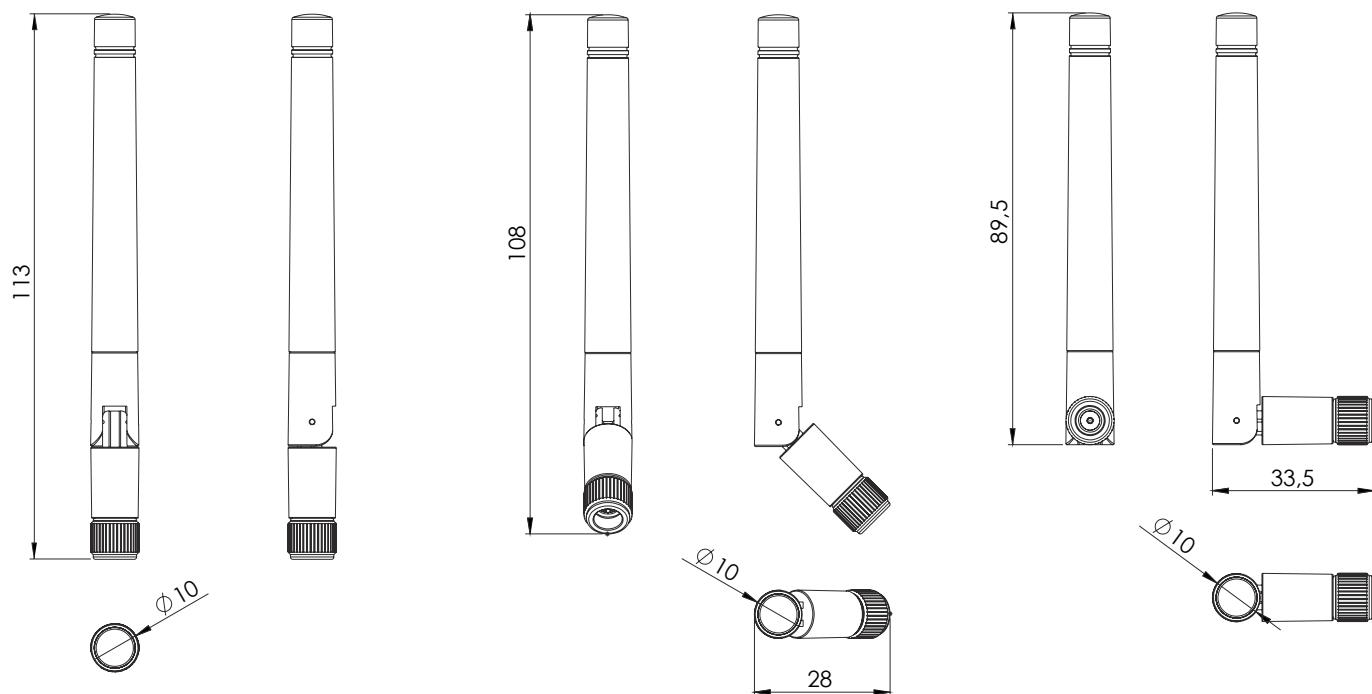

5. Antenna Images

