

2JP0383P

5G NR Rigid Fiberglass Adhesive Mount

Key Features

5G NR

- 617-960 MHz
- 1427-2690 MHz
- 3300-5000 MHz
- 5150-5925 MHz

Self-Adhesive

High Performance

Fiberglass Material

Ground Plane Independent

Dimensions 90 × 14 × 0.9 mm

Customizable Cable and Connector



1. Antenna and electrical specifications

Parameters	5GNR Antenna			
Technologies	5G, 4G, 3G and 2G			
Standards	5GNR/4GLTE/FirstNet/CBRS/LPWA/CAT-X/CAT-Mx/CAT-NBx/NB-IoT/3G/2G			
Frequency (MHz)	617-960	1427-2690	3300-5000	5150-5925
Band (MHz)	600, 700, 850, 900	1500, 1600, 1700, 1800, 1900, 2000, 2100, 2300, 2500, 2600	3300, 3500, 3600, 3700, 4500	5200, 5500, 5800
5GNR Bands	n5, n8, 12, n20, n28, n71, n81, n82, n83,	n1, n2, n3, n7, n25, n34, n38, n39, n40, n41, n50, n51, n66, n70, n74, n75, n76, n80, n84, n86	n77, n78, n79	
4GLTE Bands	B5, B6, B8, B12, B13, B14, B17, B18, B19, B20, B26, B27, B28, B29, B44, B67, B68, B71, B85	B1, B2, B3, B4, B7, B9, B10, B11, B21, B23, B24, B25, B30, B32, B33, B34, B35, B36, B37, B38, B39, B40, B41, B45, B50, B51, B65, B66, B69, B70, B74, B75, B76	B22, B42, B43, B48, B49, B52	B46, B47, B252, B255
3GCELL Bands	B5, B6, B8, B12, B13, B14, B19, B20, B26	B1, B2, B3, B4, B7, B9, B10, B11, B21, B25, B32, B33, B34, B35, B36, B37, B38, B39, B40	B22	
2GCELL Bands	710, 750, 810T, 850, 900P, 900E, 900R	1800DCS, 1900PCS		
CDMACELL Bands	BC0, BC2, BC3, BC7, BC9, BC10, BC12, BC18, BC19	BC1, BC4, BC6, BC8, BC13, BC14, BC15, BC16, BC20, BC21		
Return Loss (dB)	~-12.1	~-12.2	~-8.7	~-11.9
VSWR	~1.8:1	~1.9:1	~2.4:1	~2.1:1
Efficiency (%)	~45.3	~45.0	~40.7	~40.6
Peak Gain (dBi)	~-0.5	~1.8	~2.2	~3.1
Average Gain (dB)	~-3.8	~-3.7	~-4.5	~-4.3
Impedance (Ohm)	50			
Polarisation	Linear			
Radiation Pattern	Omni-Directional			
Max. Input Power (W)	25			
Connector Type	U.FL Standard (Other Connectors Available)			
Cable Length	180mm Standard (Any Cable Length Available)			
Cable Type	1.37mm Mini-Coax Standard (Other Cables Available)			

Antenna Measurement Conditions:

Mounted on 30 x 30 x 0.25 cm ABS Plate

150 mm of 1.37 mm Mini-Coax Cable

Measured in Certified CTIA 3D Anechoic Chamber

2. Mechanical and environmental specifications

Specifications	2JP0383P
Mounting Type	Adhesive Mount
Dimensions (mm)	90 × 14 × 0.9
Material	Rigid Fiberglass
Radome color	White
Operating Temperature (C)	-40 to +85
Storage Temperature (C)	-40 to +85
Storage Relative Humidity (%)	Up to 93 at 30 C
Substance Compliance	RoHS

3. Antenna parameters

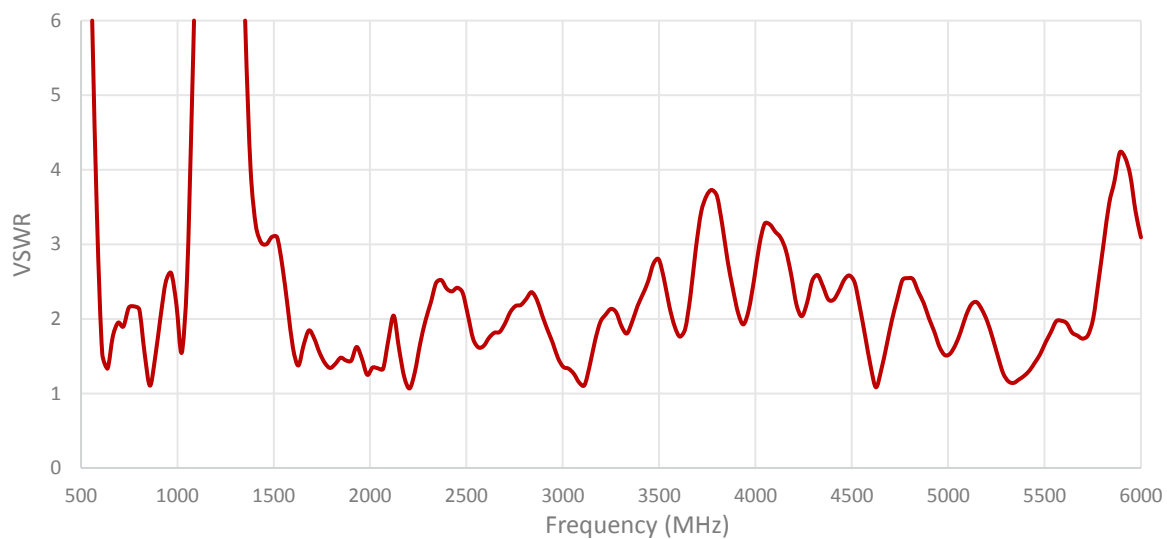
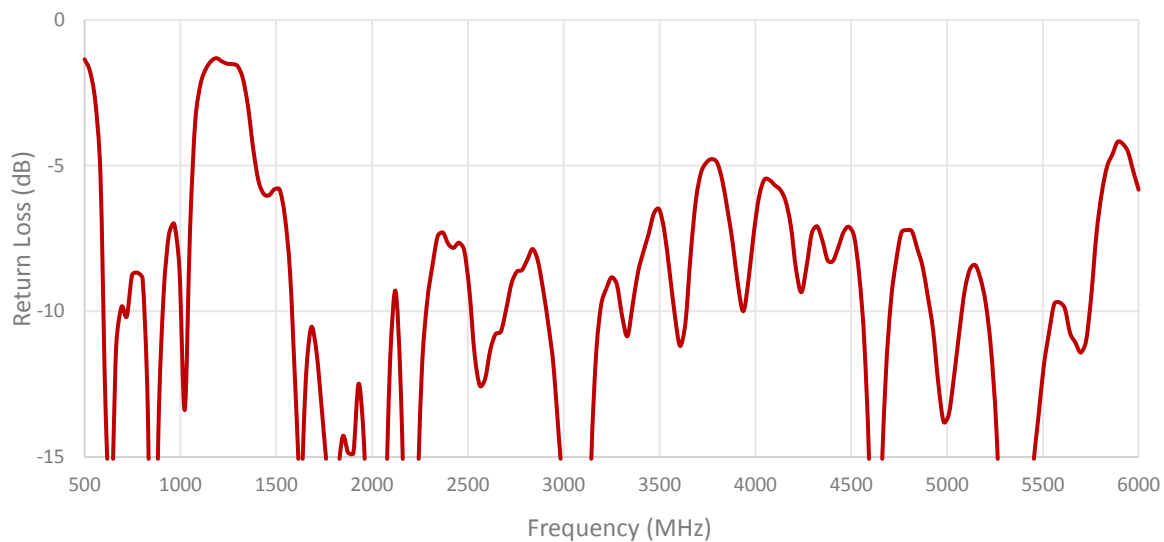

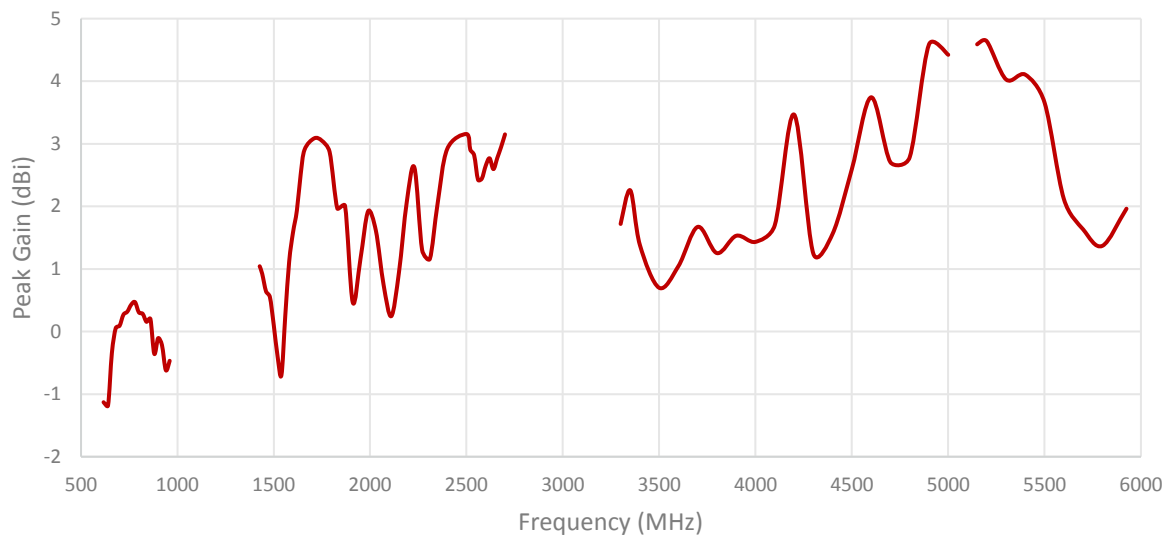
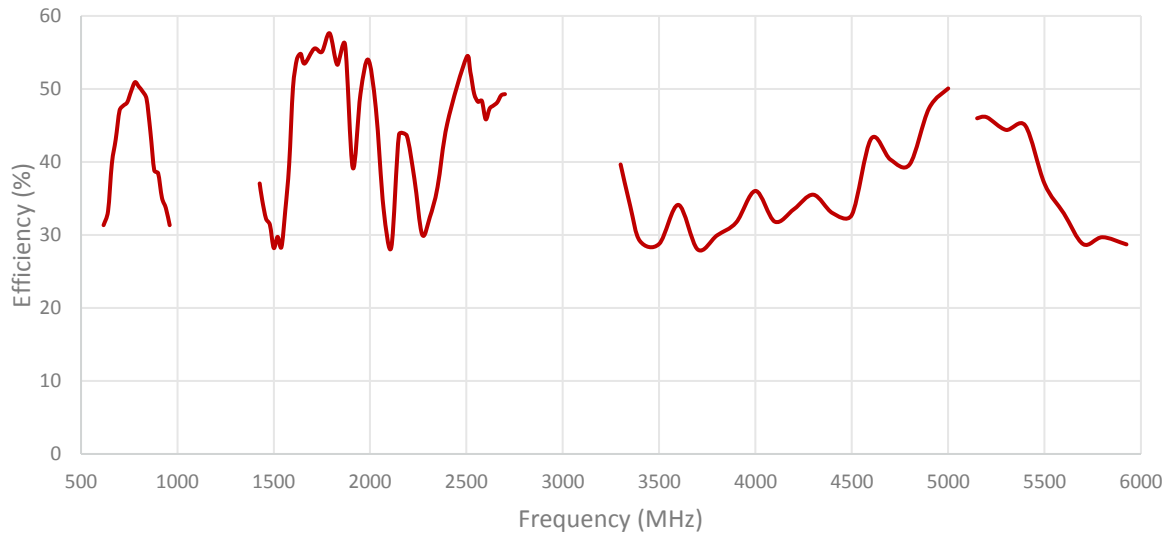

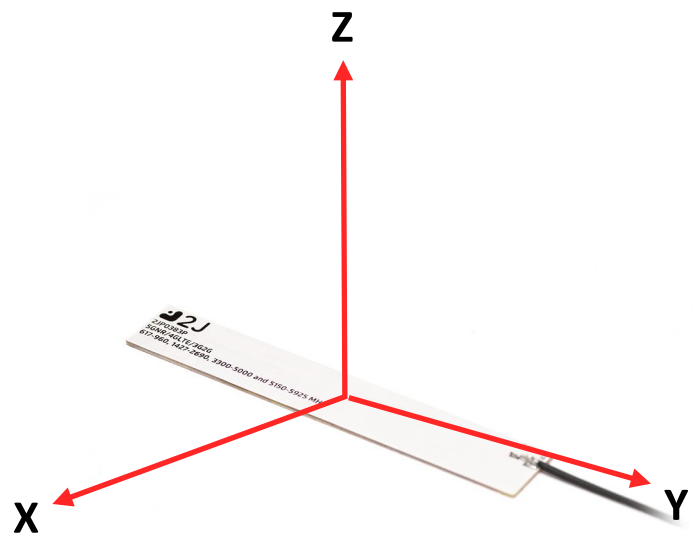
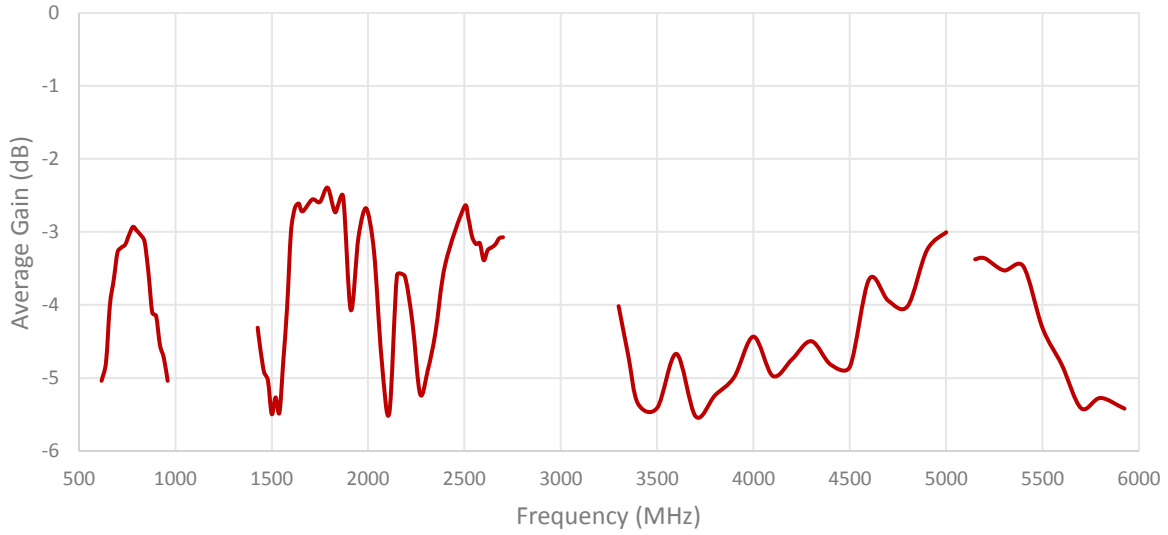

Radiation pattern reference

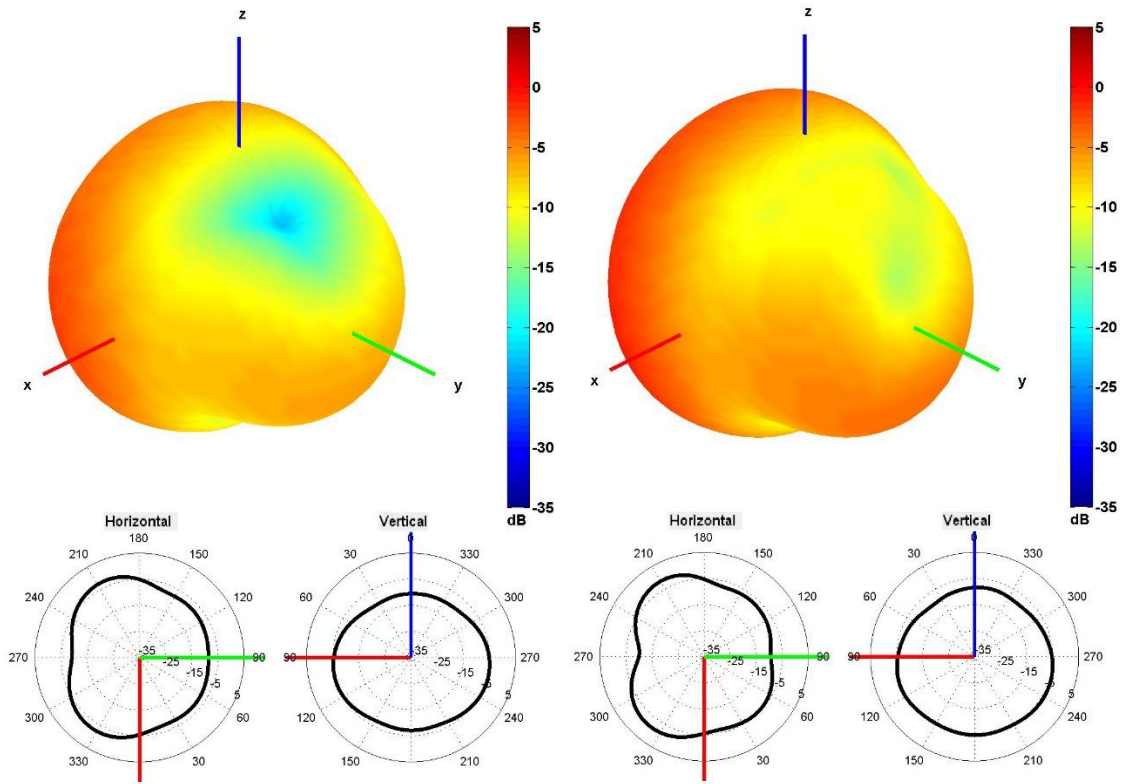

650 and 750 MHz Radiation pattern

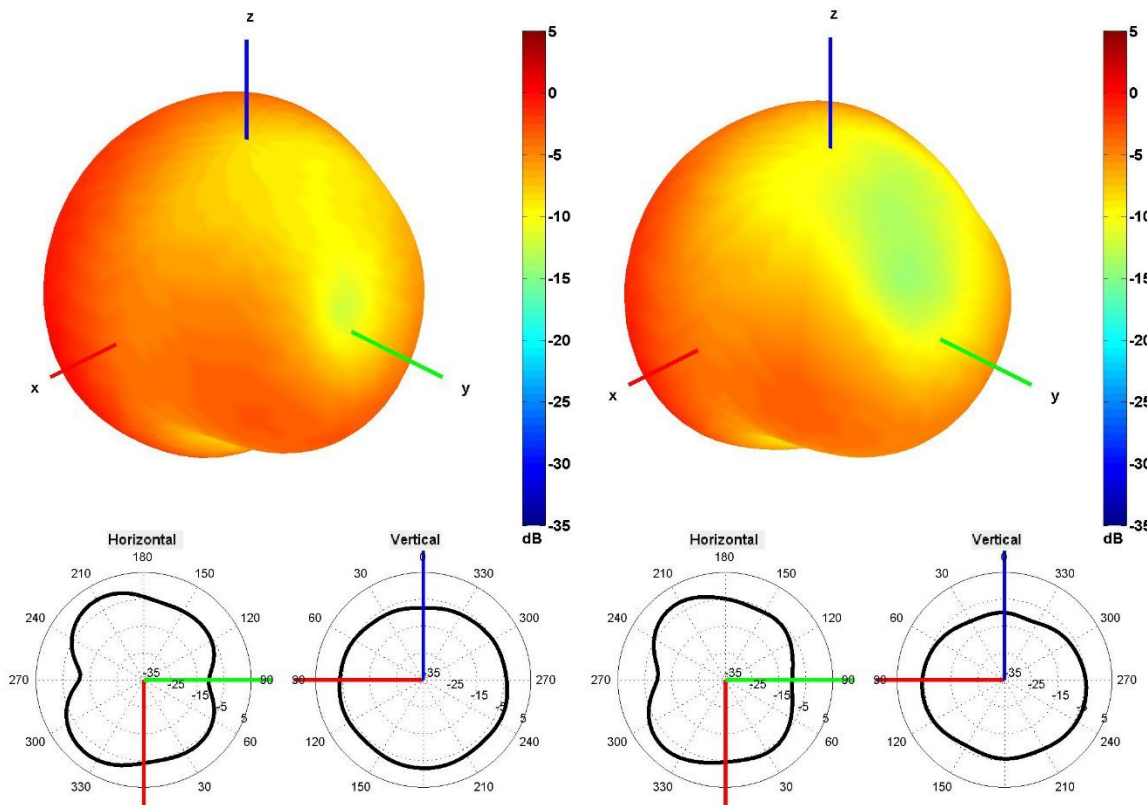

850 and 940 MHz Radiation pattern

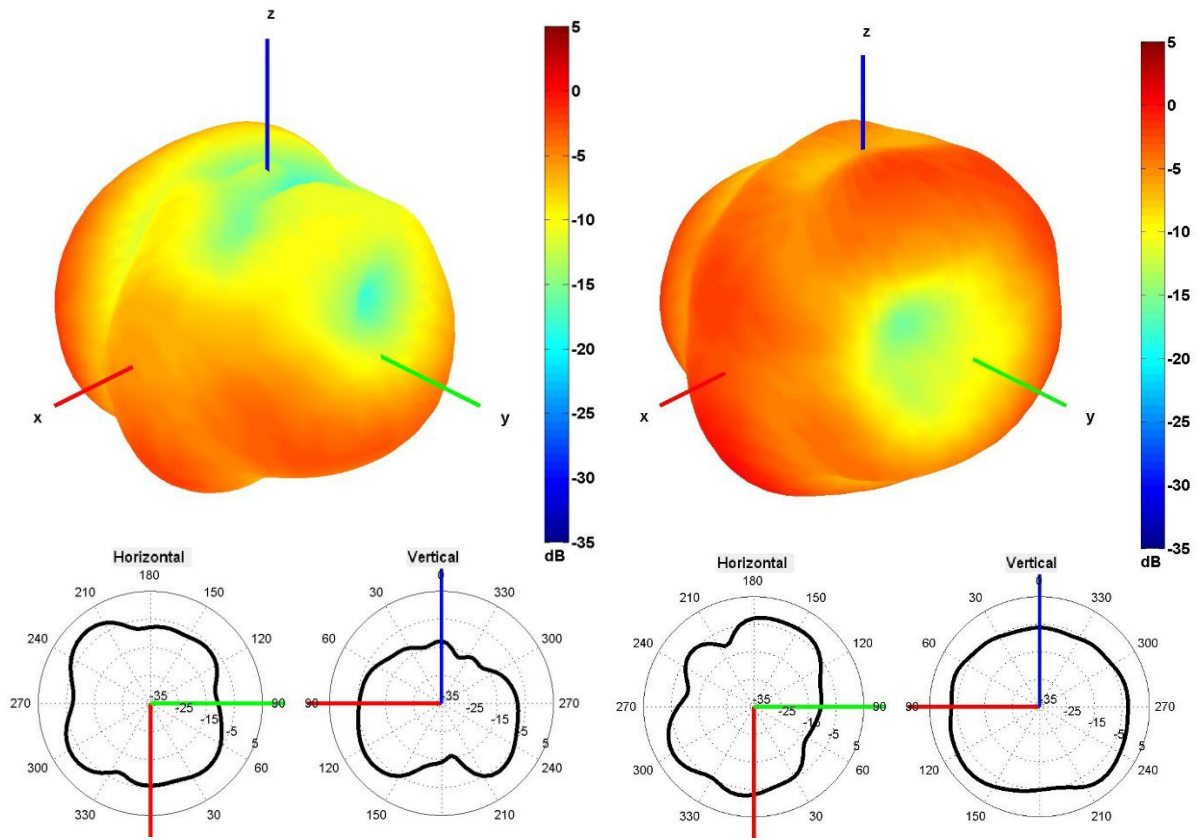

1500 and 1600 MHz Radiation pattern

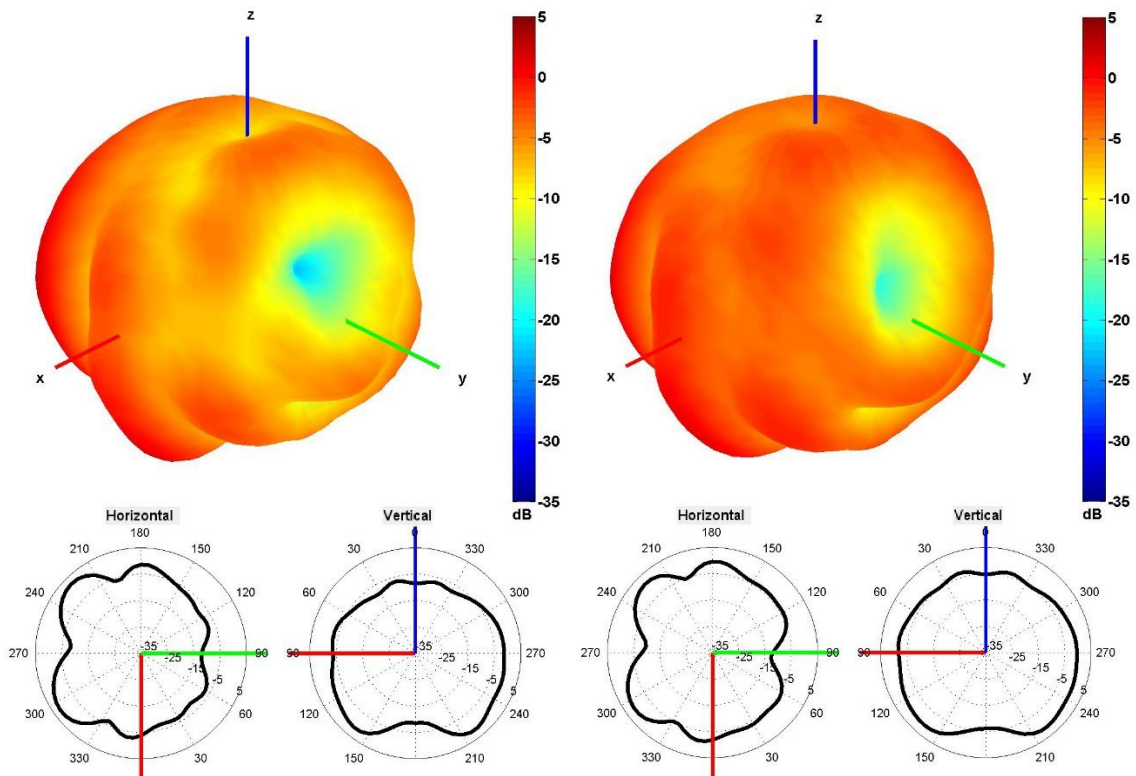

1750 and 1850 MHz Radiation pattern

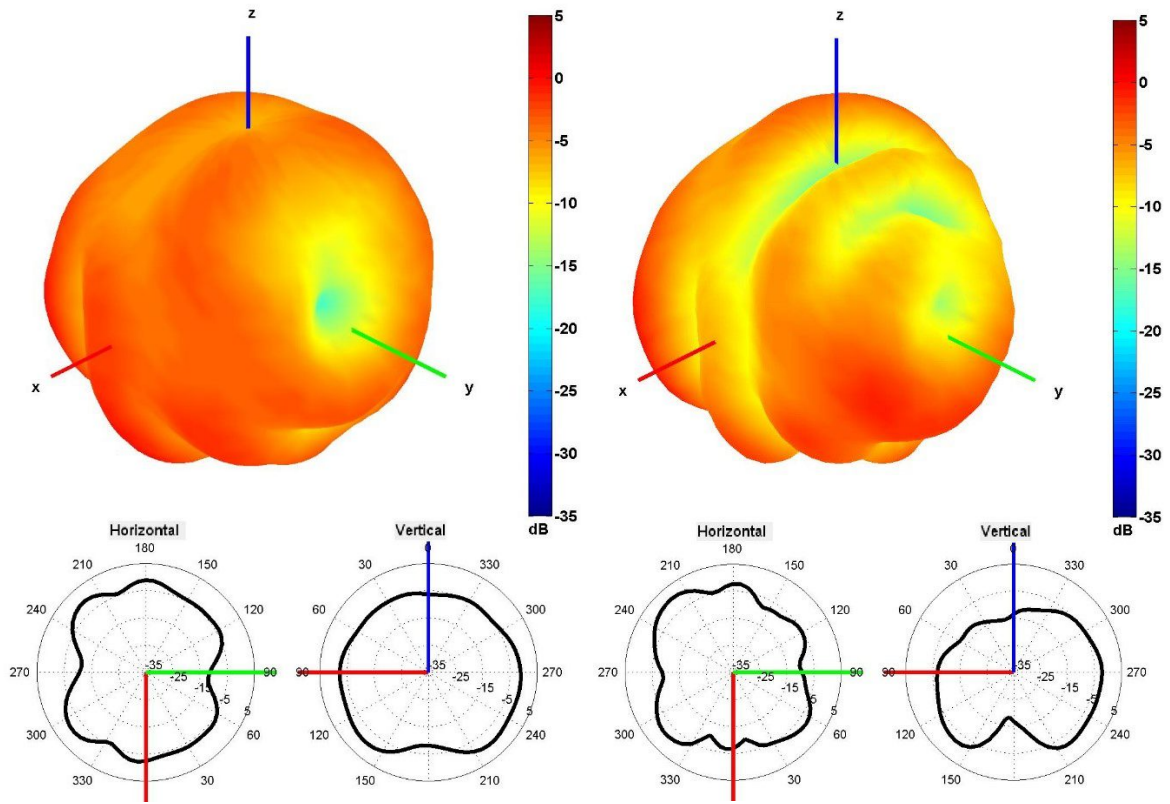

1950 and 2100 MHz Radiation pattern

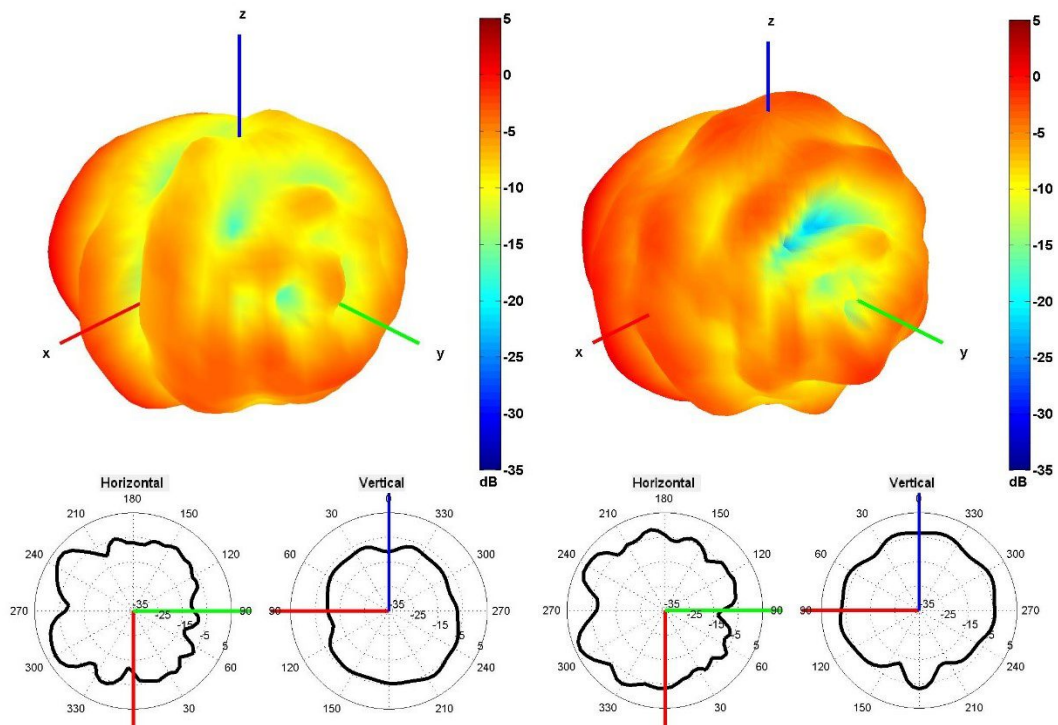

2350 and 2600 MHz Radiation pattern

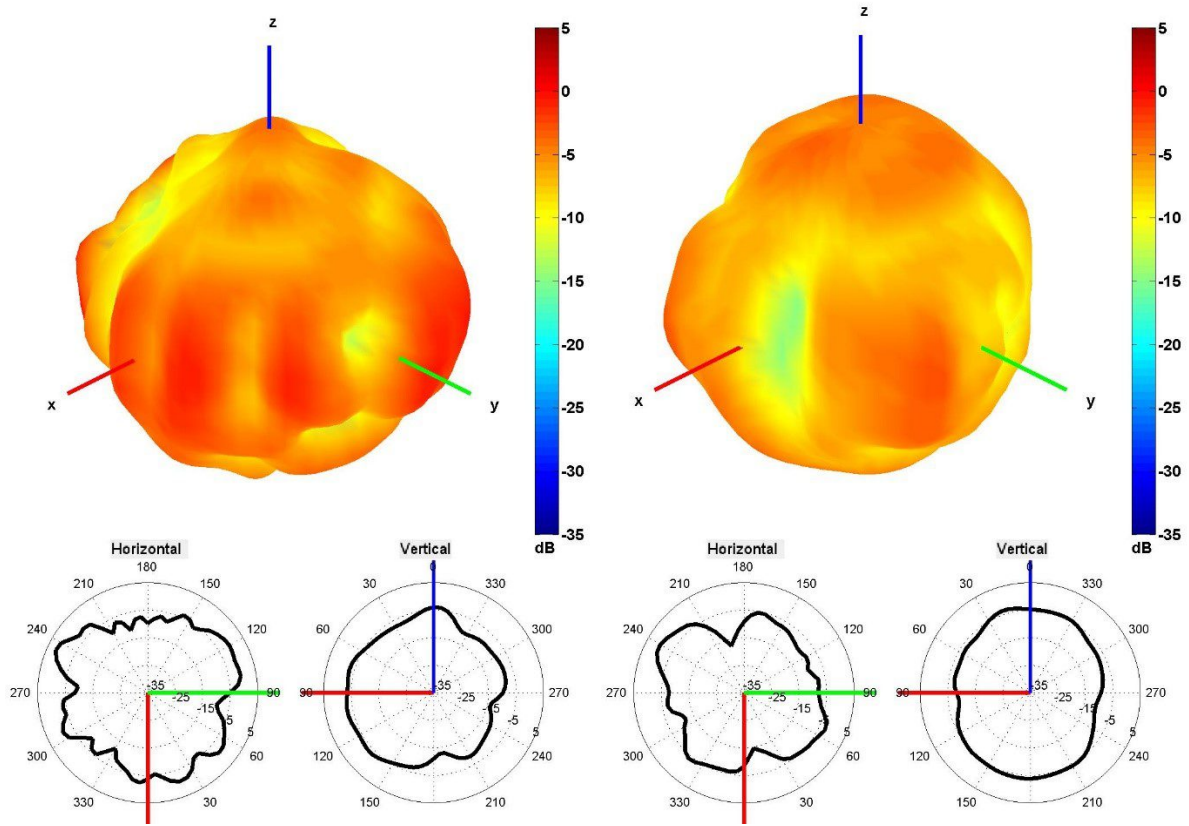

3350 and 3600 MHz Radiation pattern

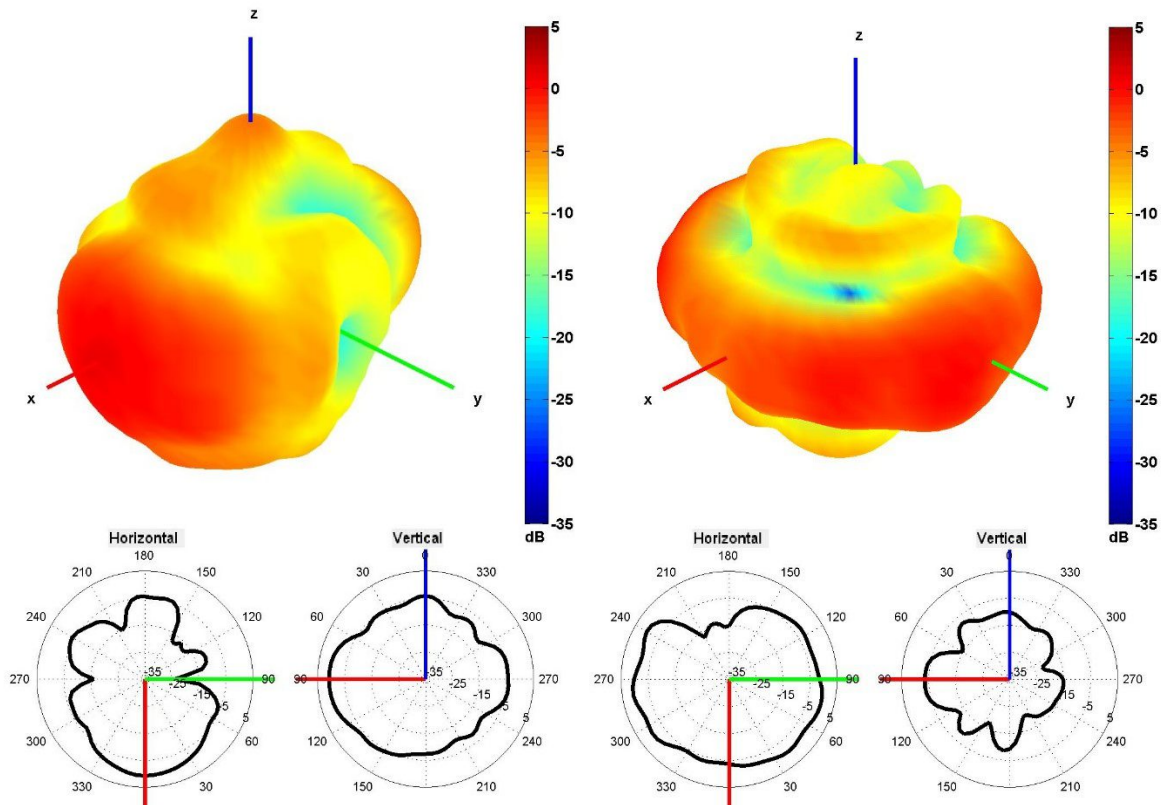

4500 and 5500 MHz Radiation pattern

4. Antenna drawings

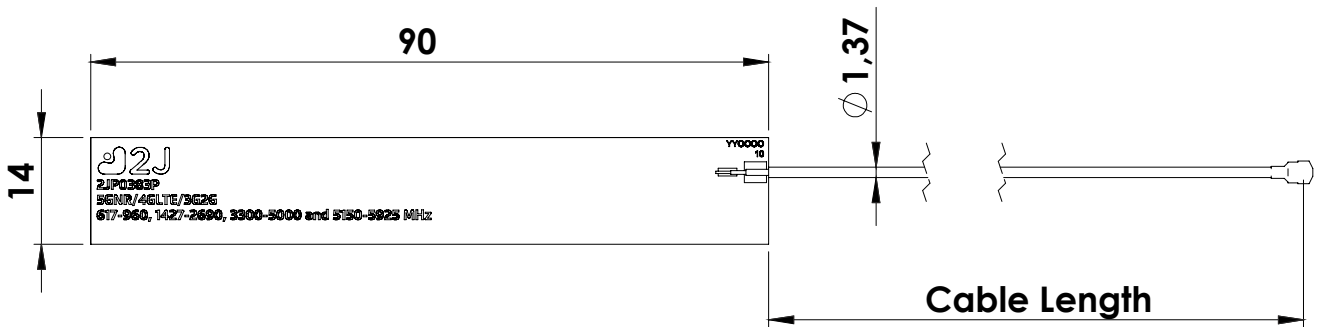
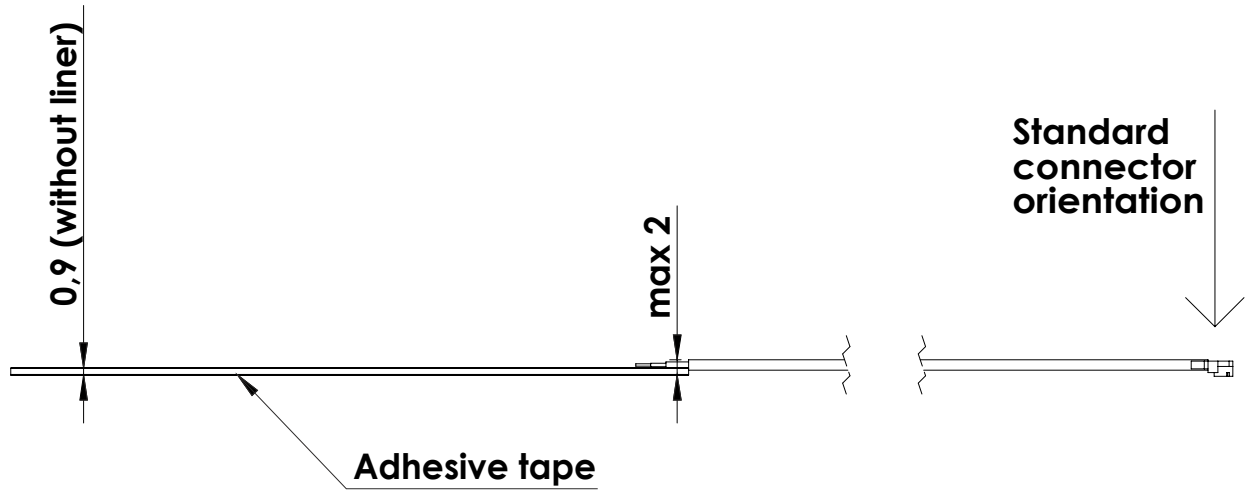

5. Antenna Images

