

A WORLD OF ENCLOSURES

EMBEDDED BOX

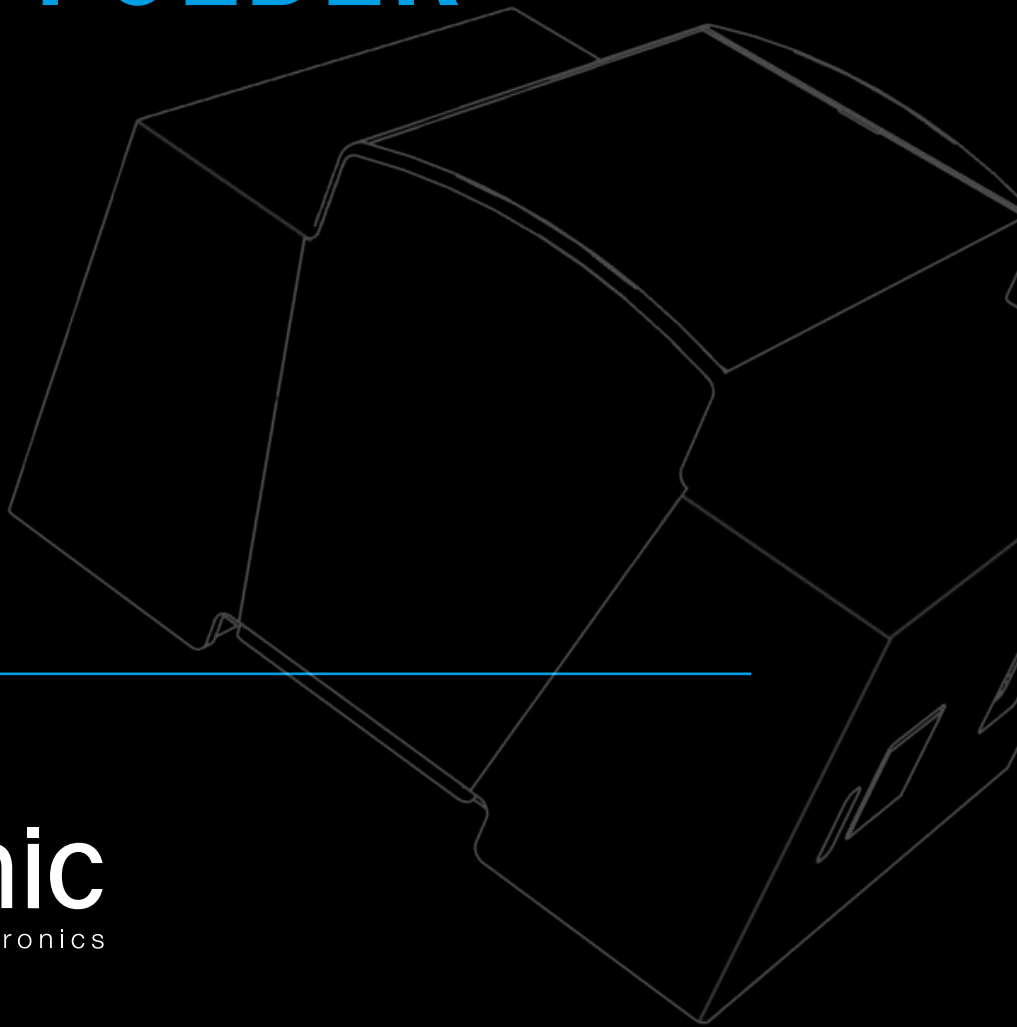













SHORT FOLDER

www.italtronic.com

italtronic
enclosures for electronics







INDICE/INDEX





ARDUINO YUN		 25.0406000.YUN	Contenitore kit completo 4M XTS/4M XTS complete enclosure kit	Pag. 7
		 33.0412000.YUN	Contenitore completo Kit 4M XTS COMPACT/4M XTS COMPACT complete enclosure	Pag. 7
		 25.0612000.YUN	Contenitore kit completo 6M XTS/6M XTS complete enclosure kit	Pag. 8
		 33.0606000.YUN	Contenitore kit completo 6M XTS COMPACT/6M XTS COMPACT complete enclosure kit	Pag. 8
ARDUINO MEGA	 	 25.0810000.MEGA	Contenitore kit completo 8M XTS/8M XTS complete enclosure kit	Pag. 10
ARDUINO UNO E 101	 	 25.0410000.UNO	Contenitore kit completo 4M XTS/4M XTS complete enclosure kit	Pag. 12
		 33.0414000.UNO	Contenitore kit completo 4M XTS COMPACT/4M XTS COMPACT complete enclosure kit	Pag. 12
ARDUINO ZERO		 25.0410000.ZERO	Contenitore kit completo 4M XTS/4M XTS complete enclosure kit	Pag. 14
		 33.0414000.ZERO	Contenitore kit completo 4M XTS COMPACT/4M XTS COMPACT complete enclosure kit	Pag. 14

INDICE/INDEX





BEAGLEBONE BLACK

		25.0410000.BGB	Contenitore kit completo 4M XTS/4M XTS complete enclosure kit	Pag. 16
		33.0414000.BGB	Contenitore kit completo 4M XTS COMPACT/4M XTS COMPACT complete enclosure kit	Pag. 16
		25.0610000.BGB	Contenitore kit completo 6M XTS/6M XTS complete enclosure kit	Pag. 17
		33.0614000.BGB	Contenitore kit completo 6M XTS COMPACT/6M XTS COMPACT complete enclosure kit	Pag. 17

BEAGLEBONE GREEN

		25.0410000.BGG	Contenitore kit completo 4M XTS/4M XTS complete enclosure kit	Pag. 19
		33.0414000.BGG	Contenitore kit completo 4M XTS COMPACT/4M XTS COMPACT complete enclosure kit	Pag. 19
		25.0610000.BGG	Contenitore kit completo 6M XTS/6M XTS complete enclosure kit	Pag. 21
		33.0614000.BGG	Contenitore kit completo 6M XTS COMPACT/6M XTS COMPACT complete enclosure kit	Pag. 21

BEAGLEBONE GREEN WIRELESS

		25.0410000.BGW	Contenitore kit completo 4M XTS/4M XTS complete enclosure kit	Pag. 23
		33.0414000.BGW	Contenitore kit completo 4M XTS COMPACT/4M XTS COMPACT complete enclosure kit	Pag. 23
		25.0610000.BGW	Contenitore kit completo 6M XTS/6M XTS complete enclosure kit	Pag. 25
		33.0614000.BGW	Contenitore kit completo 6M XTS COMPACT/6M XTS COMPACT complete enclosure kit	Pag. 25

RASPBERRY PI

		25.0410000.RPI	Contenitore kit completo 4M XTS/4M XTS complete enclosure kit	Pag. 27
---	---	----------------	---	---------

INDICE/INDEX

RASPBERRY PI B +
RASPBERRY PI 2

		25.0410000.RMB	Contenitore kit completo 4M XTS/4M XTS complete enclosure kit	Pag. 29
		33.0414000.RMB	Contenitore kit completo 4M XTS COMPACT/4M XTS COMPACT complete enclosure kit	Pag. 29
		25.0610000.RMB	Contenitore kit completo 6M XTS/6M XTS complete enclosure kit	Pag. 31
		33.0614000.RMB	Contenitore kit completo 6M XTS COMPACT/6M XTS COMPACT complete enclosure kit	Pag. 31

RASPBERRY PI 3



		25.0410000.RP3	Contenitore kit completo 4M XTS/4M XTS complete enclosure kit	Pag. 33
		33.0414000.RP3	Contenitore kit completo 4M XTS COMPACT/4M XTS COMPACT complete enclosure kit	Pag. 33
		25.0610000.RP3	Contenitore kit completo 6M XTS/6M XTS complete enclosure kit	Pag. 35
		33.0614000.RP3	Contenitore kit completo 6M XTS COMPACT/6M XTS COMPACT complete enclosure kit	Pag. 35

RASPBERRY PI
COMPUTE MODULE



		35.0814000.RCM	Contenitore kit completo 8M XTS COMPACT/8M XTS COMPACT complete enclosure kit	Pag. 37
---	---	----------------	---	---------

RASPBERRY ZERO





		25.0410000.RPZ	Contenitore kit completo 4M XTS/4M XTS complete enclosure kit	Pag. 39
		33.0414000.RPZ	Contenitore kit completo 4M XTS COMPACT/4M XTS COMPACT complete enclosure kit	Pag. 39

		25.0410000.RP4	Contenitore kit completo 4M XTS/4M XTS complete enclosure kit	Pag. 41
RaspberryPi		33.0414000.RP4	Contenitore kit completo 4M XTS COMPACT/4M XTS COMPACT complete enclosure kit	Pag. 41
		25.0610000.RP4	Contenitore kit completo 6M XTS/6M XTS complete enclosure kit	Pag. 43
RaspberryPi		33.0614000.RP4	Contenitore kit completo 6M XTS COMPACT/6M XTS COMPACT complete enclosure kit	Pag. 43

		10.0012225.RP1	Contenitore kit completo 22,5 railbox/22,5 railbox enclosure kit	Pag. 45
RaspberryPi		10.0052450.RP1	Contenitore kit completo 45 railbox/45 railbox complete enclosure kit	Pag. 45
		10.0012225.RMB	Contenitore kit completo 22,5 railbox/22,5 railbox complete enclosure kit	Pag. 46
RaspberryPi		10.0052450.RMB	Contenitore kit completo 45 railbox/45 railbox complete enclosure kit	Pag. 46
		10.0012225.RP3	Contenitore kit completo 22,5 railbox/22,5 railbox enclosure kit	Pag. 47
RaspberryPi		10.0052450.RP3	Contenitore kit completo 45 railbox/45 railbox complete enclosure kit	Pag. 47
		10.0012225.RP4	Contenitore kit completo 22,5 railbox/22,5 railbox enclosure kit	Pag. 48
RaspberryPi		10.0052450.RP4	Contenitore kit completo 45 railbox/45 railbox complete enclosure kit	Pag. 48

		25.0410000.OC1	Contenitore kit completo 4M XTS/4M XTS complete enclosure kit	Pag. 50
---	---	----------------	---	---------

		25.0410000.OCP	Contenitore kit completo 4M XTS/4M XTS complete enclosure kit	Pag. 52
	25.0610000.OCP	Contenitore kit completo 6M XTS/6M XTS complete enclosure kit	Pag. 52	

	25.000EMB1	Kit accessorio per base embedded EMB 1/Accessory for Embedded base EMB 1	Pag. 53
	25.000EMB2	Kit accessorio per base embedded EMB 2/Accessory for Embedded base EMB 2	Pag. 53
	25.000EMB3	Kit accessorio per base embedded EMB 3/Accessory for Embedded base EMB 3	Pag. 54
	25.000EMB4	Kit accessorio per base embedded EMB 4/Accessory for Embedded base EMB 4	Pag. 54

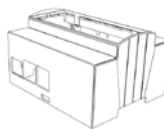
	Finishing service	Pag. 55
---	-------------------	---------

ARDUINO YUN GENERAL FEATURES ARDUINO YUN for rail din (EN 60715) applica- tion.

Material: PC/ABS self-extinguishing UL94V-0
Colour: Grey

DIN RAIL (EN 60715) ENCLOSURE

Italtronic propose a new industrial and HOME & BUILDING AUTOMATION enclosures useful to contain the more famous EMBEDDED electronic boards.

ARDUINO YUN CARATTERISTICHE GENERALI Contenitori per ARDUINO YUN per guida DIN (EN 60715)

Materiale: PC/ABS autoestinguente UL94V-0
Colore: Grigio

CONTENITORE PER GUIDA DIN (EN 60715)

Italtronic propone una nuova linea di contenitori industriali e per HOME & BUILDING AUTOMATION adatti a contenere le più note schede elettroniche EMBEDDED.

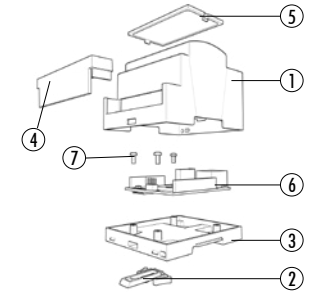

- Descrizione/Description:**
- 1) Corpo contenitore/Body enclosure
 - 2) Gancio/Hook
 - 3) Base/Base
 - 4) Coprimorsetto/Terminal cover
 - 5) Pannello/Panel
 - 6) Circuito stampato*/Pcb*
 - 7) Viti/Screws
- * Non incluso / Not included

Contenitore Completo/Complete Enclosure

CODICE / CODE	COLORE / COLOUR	DESCRIZIONE/DESCRIPTION	FORMA/SHAPE
25.0406000.YUN	Grigio/Grey	Kit 4M XTS Arduino YUN /4M XTS Arduino YUN kit	B/B

Composizione Kit: il Kit comprende corpo, base, gancio, pannello trasparente, coprimorsetto, 3 viti.

Kit composition: kit includes body enclosure, base, hook, transparent panel, terminal cover, 3 screws.

DIMENSIONI B/B DIMENSIONS: 90 mm
DIMENSIONI L/L DIMENSIONS: 71 mm
DIMENSIONI H/H DIMENSIONS: 55 mm

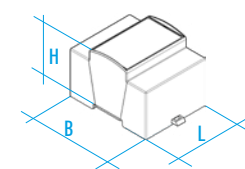

CONFEZIONE N° PCS/KIT: PACKAGING N° PCS/KIT: 50	PESO DELLA CONFEZIONE: PACKAGING WEIGHT: 4,5 kg	MINIMO ACQUISTABILE: MINIMUM ORDER: 1	PESO DEL PEZZO KIT: KIT WEIGHT: 70 g
--	--	--	---

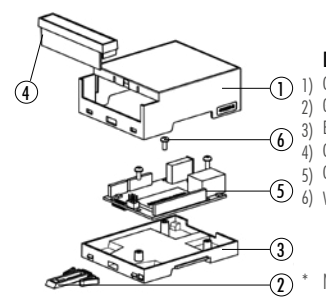
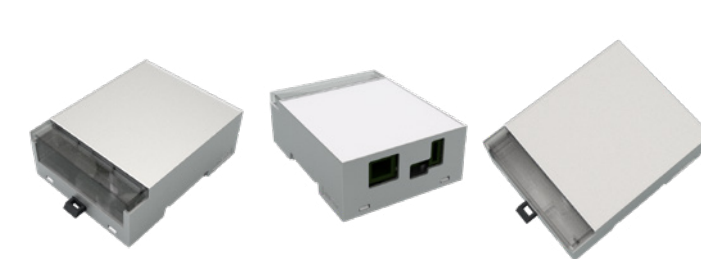

- Descrizione/Description:**
- 1) Corpo contenitore/Body enclosure
 - 2) Gancio/Hook
 - 3) Base/Base
 - 4) Coprimorsetto/Terminal cover
 - 5) Circuito stampato*/Pcb*
 - 6) Viti/Screws
- * Non incluso / Not included

Contenitore Completo/Complete Enclosure

CODICE / CODE	COLORE / COLOUR	DESCRIZIONE/DESCRIPTION	FORMA/SHAPE
33.0412000.YUN	Grigio/Grey	Kit 4M XTS COMPACT Arduino YUN /4M XTS COMPACT Arduino YUN kit	B/B

Composizione Kit: il Kit comprende corpo, base, gancio, coprimorsetto trasparente, 3 viti.

Kit composition: kit includes body enclosure, base, hook, transparent terminal cover, 3 screws.

DIMENSIONI B/B DIMENSIONS: 90 mm
DIMENSIONI L/L DIMENSIONS: 71 mm
DIMENSIONI H/H DIMENSIONS: 32 mm

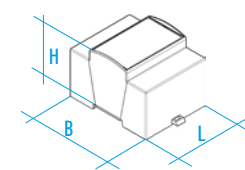

CONFEZIONE N° PCS/KIT: PACKAGING N° PCS/KIT: 100	PESO DELLA CONFEZIONE: PACKAGING WEIGHT: 6 kg	MINIMO ACQUISTABILE: MINIMUM ORDER: 1	PESO DEL PEZZO KIT: KIT WEIGHT: 50 g
---	--	--	---

TIPO GUIDA DIN/DIN RAIL TYPE: Norme EN 60715/EN 60715 NORM
NORMA CONTENITORE/ENCLOSURE STANDARD: Norme DIN 43880/43880 DIN NORM



ASSEMBLAGGIO/DISASSEMBLAGGIO

ASSEMBLY/DISASSEMBLY

ARDUINO YUN

ARDUINO YUN

MONTAGGIO/ASSEMBLY

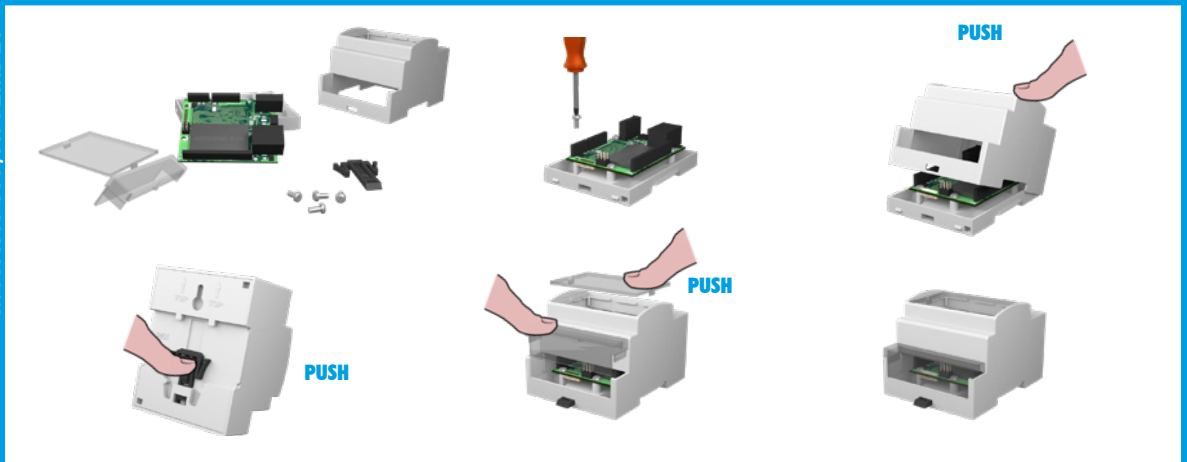

SMONTAGGIO/DISASSEMBLY

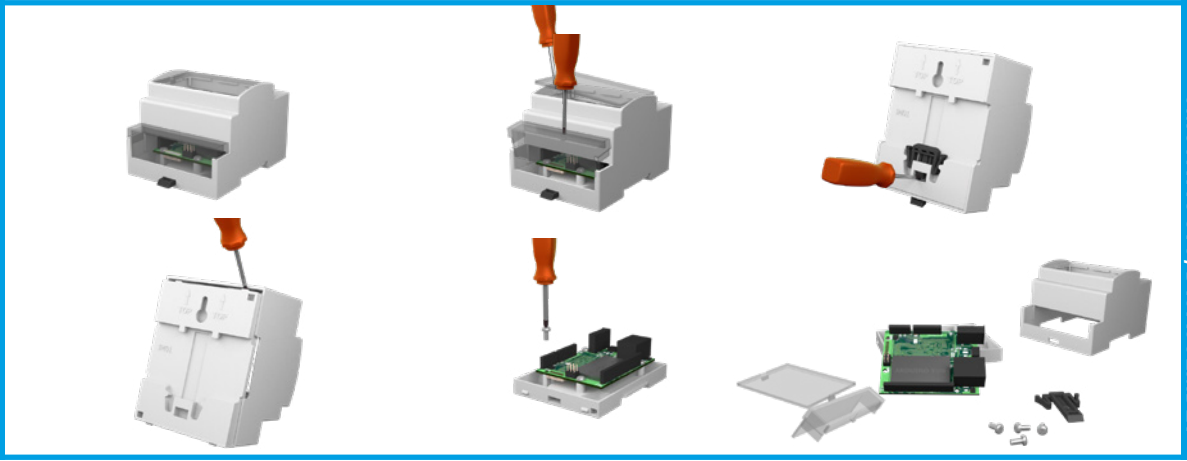

ARDUINO YUN compact

ARDUINO YUN compact

MONTAGGIO/ASSEMBLY

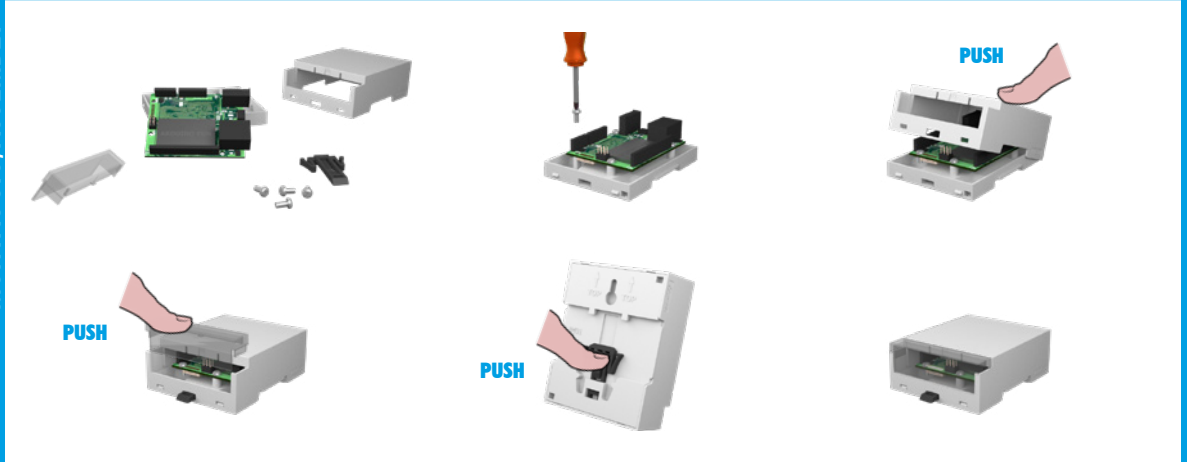

SMONTAGGIO/DISASSEMBLY

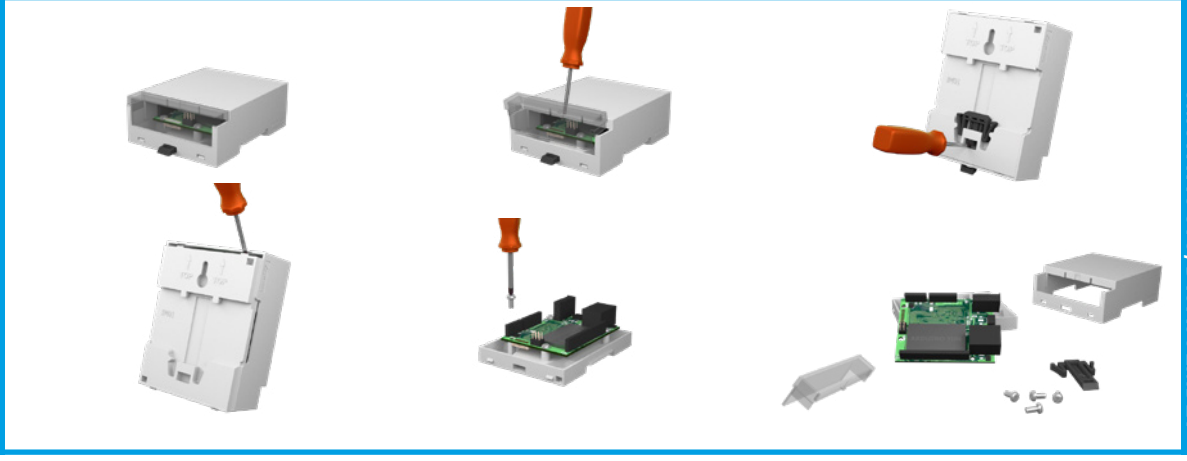

ARDUINO YUN

CARATTERISTICHE GENERALI

Contenitori per ARDUINO YUN per guida DIN (EN 60715)

Materiale: PC/ABS autoestinguente UL94V-0
Colore: Grigio

CONTENITORE PER GUIDA DIN (EN 60715)

Italtronic propone una nuova linea di contenitori industriali e per HOME & BUILDING AUTOMATION adatti a contenere le più note schede elettroniche EMBEDDED.



ARDUINO YUN

GENERAL FEATURES

ARDUINO YUN for rail din (EN 60715) application.

Material: PC/ABS self-extinguishing UL94V-0
Colour: Grey

DIN RAIL (EN 60715) ENCLOSURE

Italtronic propose a new industrial and HOME & BUILDING AUTOMATION enclosures useful to contain the more famous EMBEDDED electronic boards.

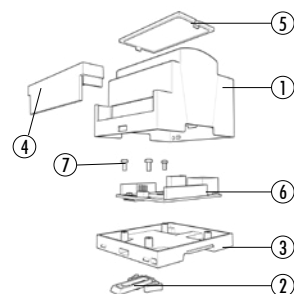

Descrizione/Description:

- 1) Corpo contenitore/Body enclosure
- 2) Gancio/Hook
- 3) Base/Base
- 4) Coprimorsetto/Terminal cover
- 5) Pannello/Panel
- 6) Circuito stampato*/Pcb*
- 7) Viti/Screws

* Non incluso / Not included

Contenitore Completo/Complete Enclosure

CODICE / CODE	COLORE / COLOUR	DESCRIZIONE/DESCRIPTION	FORMA/SHAPE
25.0612000.YUN	Grigio/Grey	Kit 6M XTS Arduino YUN /6M XTS Arduino YUN kit	B/B

Composizione Kit: il Kit comprende corpo, base, gancio, pannello trasp., 2 coprimorsetti, 3 viti.

Kit composition: kit includes body enclosure, base, hook, transparent panel, 2 terminal cover, 3 screws.

DIMENSIONI B/B DIMENSIONS: 90 mm
DIMENSIONI L/L DIMENSIONS: 106,5 mm
DIMENSIONI H/H DIMENSIONS: 55 mm

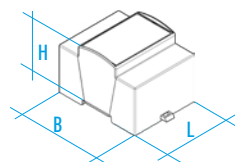

CONFEZIONE N° PCS/KIT: PACKAGING N° PCS/KIT:	PESO DELLA CONFEZIONE: PACKAGING WEIGHT:	MINIMO ACQUISTABILE: MINIMUM ORDER:	PESO DEL PEZZO KIT: KIT WEIGHT:
25	3,5 kg	1	90 g

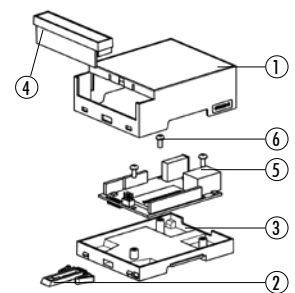
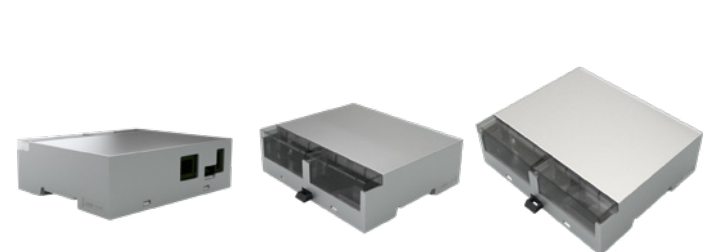

Descrizione/Description:

- 1) Corpo contenitore/Body enclosure
- 2) Gancio/Hook
- 3) Base/Base
- 4) Coprimorsetto/Terminal cover
- 5) Circuito stampato*/Pcb*
- 6) Viti/Screws

* Non incluso / Not included

Contenitore Completo/Complete Enclosure

CODICE / CODE	COLORE / COLOUR	DESCRIZIONE/DESCRIPTION	FORMA/SHAPE
33.0606000.YUN	Grigio/Grey	Kit 6M XTS COMPACT Arduino YUN /6M XTS COMPACT Arduino YUN kit	B/B

Composizione Kit: il Kit comprende corpo, base, gancio, 2 coprimorsetti trasparenti, 3 viti

Kit composition: kit includes body enclosure, base, hook, 2 transparent terminal cover, 3 screws.

DIMENSIONI B/B DIMENSIONS: 90 mm
DIMENSIONI L/L DIMENSIONS: 106,5 mm
DIMENSIONI H/H DIMENSIONS: 32 mm

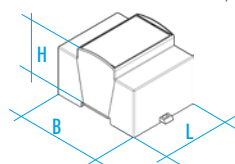

CONFEZIONE N° PCS/KIT: PACKAGING N° PCS/KIT:	PESO DELLA CONFEZIONE: PACKAGING WEIGHT:	MINIMO ACQUISTABILE: MINIMUM ORDER:	PESO DEL PEZZO KIT: KIT WEIGHT:
50	4,75 kg	1	75 g

TIPO GUIDA DIN/DIN RAIL TYPE: Norme EN 60715/EN 60715 NORM
NORMA CONTENITORE/ENCLOSURE STANDARD: Norme DIN 43880/43880 DIN NORM



ASSEMBLAGGIO/DISASSEMBLAGGIO

ASSEMBLY/DISASSEMBLY

ARDUINO MEGA

ARDUINO MEGA

MONTAGGIO/ASSEMBLY

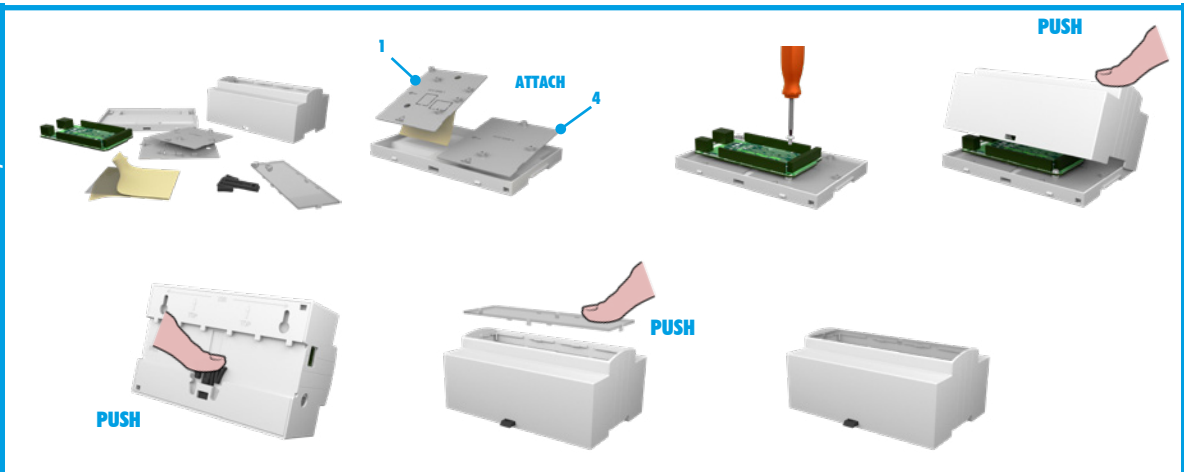

SMONTAGGIO/DISASSEMBLY

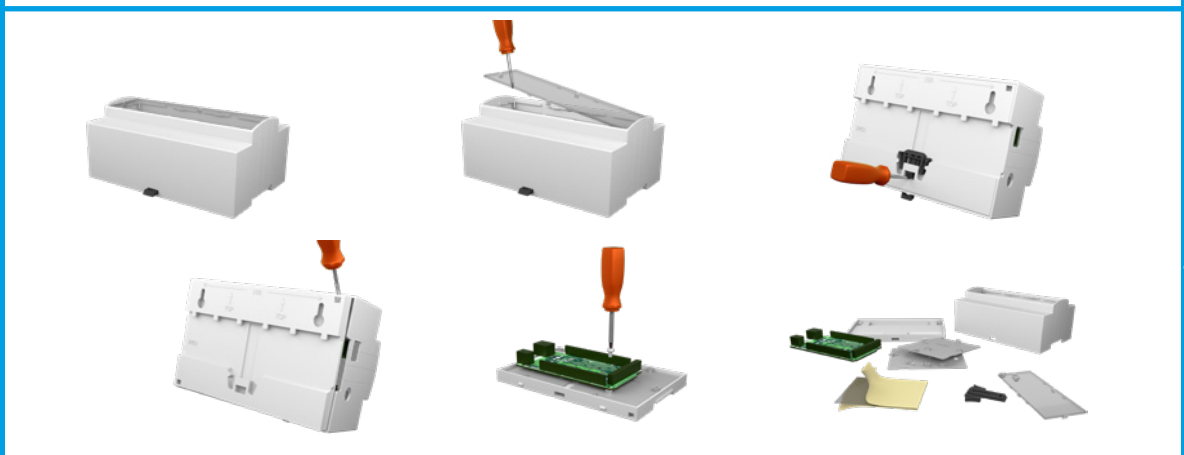

ARDUINO MEGA

CARATTERISTICHE GENERALI

Contenitore per ARDUINO MEGA per guida DIN (EN 60715)

Materiale: PC/ABS autoestinguente UL94V-0
Colore: Grigio

CONTENITORE PER GUIDA DIN (EN 60715)

Italtronic propone una nuova linea di contenitori industriali e per HOME & BUILDING AUTOMATION adatti a contenere le più note schede elettroniche EMBEDDED.



ARDUINO MEGA

GENERAL FEATURES

ARDUINO MEGA for rail din (EN 60715) application.

Material: PC/ABS self-extinguishing UL94V-0
Colour: Grey

DIN RAIL (EN 60715) ENCLOSURE

Italtronic propose a new industrial and HOME & BUILDING AUTOMATION enclosures useful to contain the more famous EMBEDDED electronic boards.

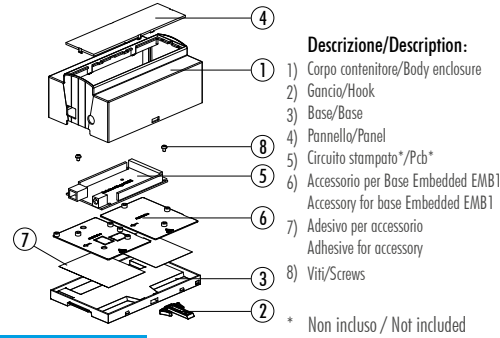

Contenitore Completo/Complete Enclosure

CODICE / CODE	COLORE / COLOUR	DESCRIZIONE/DESCRIPTION	FORMA/SHAPE
25.0810000.MEGA	Grigio/Grey	Kit 8M XTS Arduino MEGA/8M XTS Arduino MEGA kit	C/C

Composizione Kit: il Kit comprende corpo, base, gancio, pannello trasp., 2 accessori base embedded, 2 adesivi, 2 viti.

Kit composition: kit includes body enclosure, base, hook, transparent panel, 2 accessories for base embedded, 2 adhesives for accessories, 2 screws.

DIMENSIONI B/B DIMENSIONS: 90 mm
DIMENSIONI L/L DIMENSIONS: 142,5 mm
DIMENSIONI H/H DIMENSIONS: 55 mm

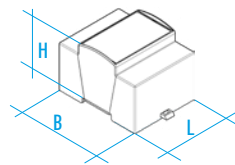

CONFEZIONE N° PCS/KIT: PACKAGING N° PCS/KIT:	PESO DELLA CONFEZIONE: PACKAGING WEIGHT:	MINIMO ACQUISTABILE: MINIMUM ORDER:	PESO DEL PEZZO KIT: KIT WEIGHT:
25	4,25 kg	1	130 g

TIPO GUIDA DIN/DIN RAIL TYPE: Norme EN 60715/EN 60715 NORM
NORMA CONTENITORE/ENCLOSURE STANDARD: Norme DIN 43880/43880 DIN NORM



ASSEMBLAGGIO/DISASSEMBLAGGIO

ASSEMBLY/DISASSEMBLY

ARDUINO UNO

ARDUINO UNO

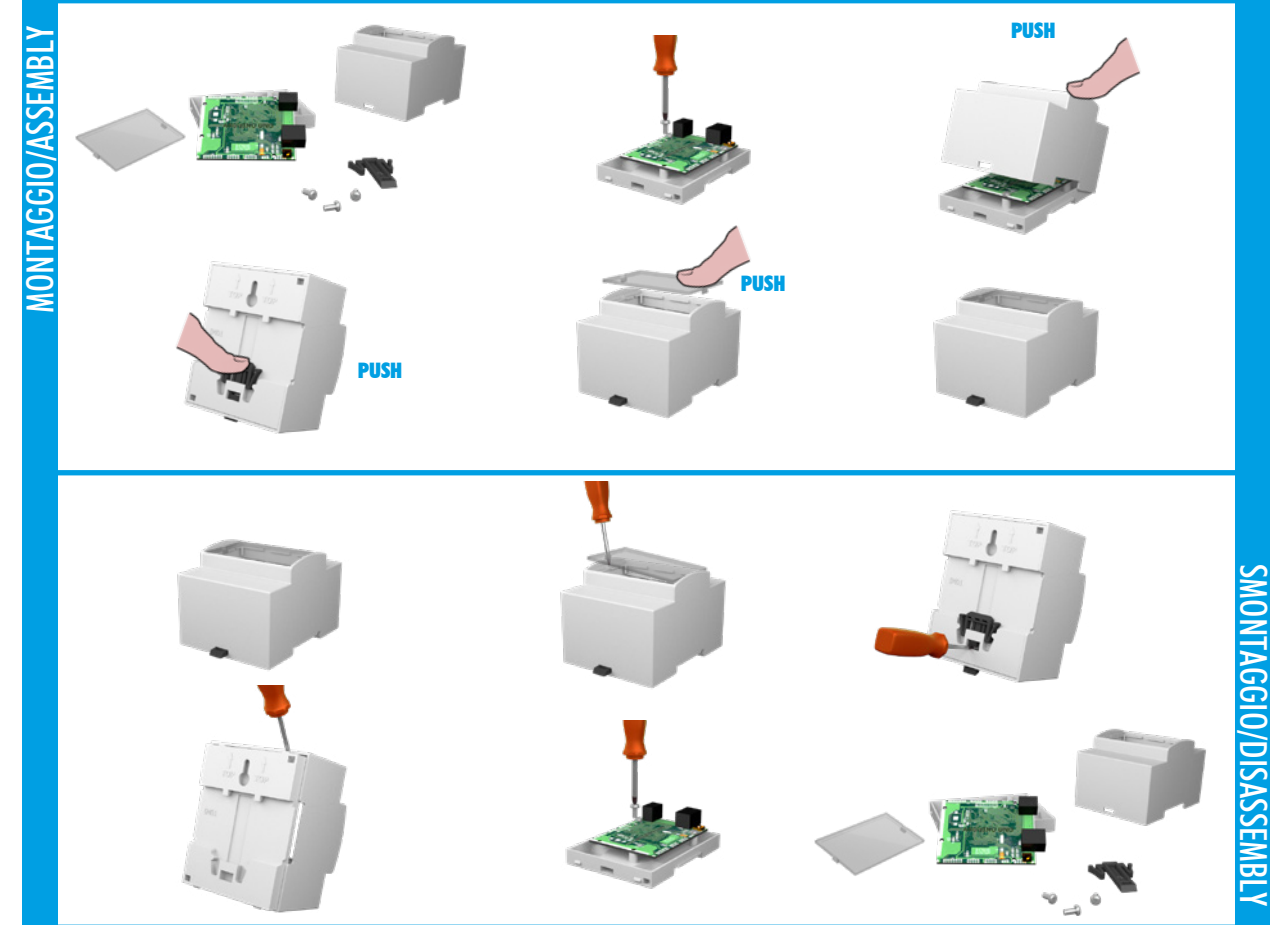

ARDUINO UNO compact

ARDUINO UNO compact

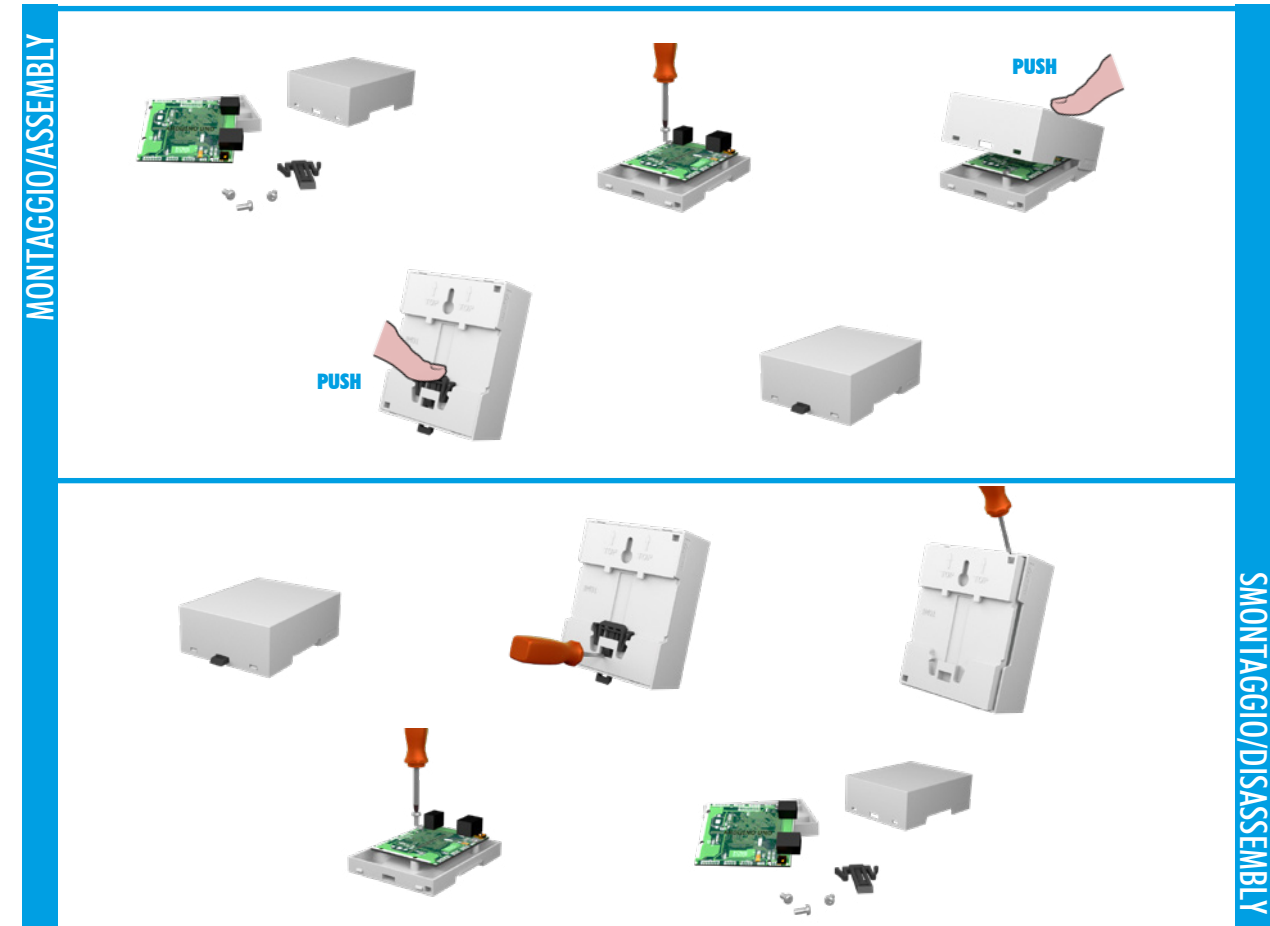

ARDUINO UNO E 101

CARATTERISTICHE GENERALI

Contenitore per ARDUINO UNO e 101 per guida DIN (EN 60715)

Materiale: PC/ABS autoestinguente UL94V-0
Colore: Grigio

CONTENITORE PER GUIDA DIN (EN 60715)

Italtronic propone una nuova linea di contenitori industriali e per HOME & BUILDING AUTOMATION adatti a contenere le più note schede elettroniche EMBEDDED.



ARDUINO UNO AND 101

GENERAL FEATURES

ARDUINO UNO and 101 for rail din (EN 60715) application

Material: PC/ABS self-extinguishing UL94V-0
Colour: Grey

DIN RAIL (EN 60715) ENCLOSURE

Italtronic propose a new industrial and HOME & BUILDING AUTOMATION enclosures useful to contain the more famous EMBEDDED electronic boards

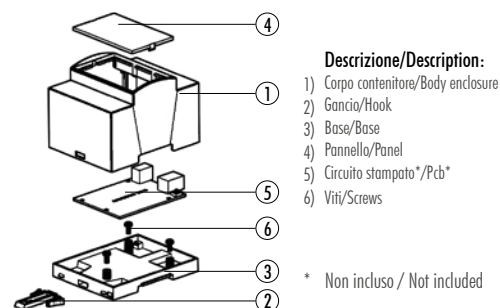

Contenitore Completo/Complete Enclosure

CODICE / CODE	COLORE / COLOUR	DESCRIZIONE/DESCRIPTION	FORMA/SHAPE
25.0410000.UNO	Grigio/Grey	kit 4M XTS Arduino UNO e 101/4M XTS Arduino UNO and 101 kit	C/C

Composizione Kit: il Kit comprende corpo, base, gancio, pannello trasp., 3 viti.

Kit composition: kit includes body enclosure, base, hook, transparent panel, 3 screws.

DIMENSIONI B/B DIMENSIONS: 90 mm
DIMENSIONI L/L DIMENSIONS: 71 mm
DIMENSIONI H/H DIMENSIONS: 55 mm

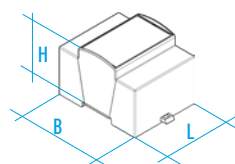

CONFEZIONE N° PCS/KIT: PACKAGING N° PCS/KIT:	PESO DELLA CONFEZIONE: PACKAGING WEIGHT:	MINIMO ACQUISTABILE: MINIMUM ORDER:	PESO DEL PEZZO KIT: KIT WEIGHT:
50	4,5 kg	1	70 g



Contenitore Completo/Complete Enclosure

CODICE / CODE	COLORE / COLOUR	DESCRIZIONE/DESCRIPTION	FORMA/SHAPE
33.0414000.UNO	Grigio/Grey	kit 4M XTS COMPACT Arduino UNO e 101/4M XTS COMPACT Arduino UNO and 101 kit	C/C

Composizione Kit: il Kit comprende corpo, base, gancio, 3 viti.

Kit composition: kit includes body enclosure, base, hook, 3 screws.

DIMENSIONI B/B DIMENSIONS: 90 mm
DIMENSIONI L/L DIMENSIONS: 71 mm
DIMENSIONI H/H DIMENSIONS: 32 mm

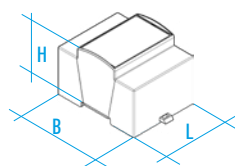

CONFEZIONE N° PCS/KIT: PACKAGING N° PCS/KIT:	PESO DELLA CONFEZIONE: PACKAGING WEIGHT:	MINIMO ACQUISTABILE: MINIMUM ORDER:	PESO DEL PEZZO KIT: KIT WEIGHT:
100	6 kg	1	50 g

TIPO GUIDA DIN/DIN RAIL TYPE: Norme EN 60715/EN 60715 NORM
NORMA CONTENITORE/ENCLOSURE STANDARD: Norme DIN 43880/43880 DIN NORM



ASSEMBLAGGIO/DISASSEMBLAGGIO

ASSEMBLY/DISASSEMBLY

ARDUINO ZERO

ARDUINO ZERO

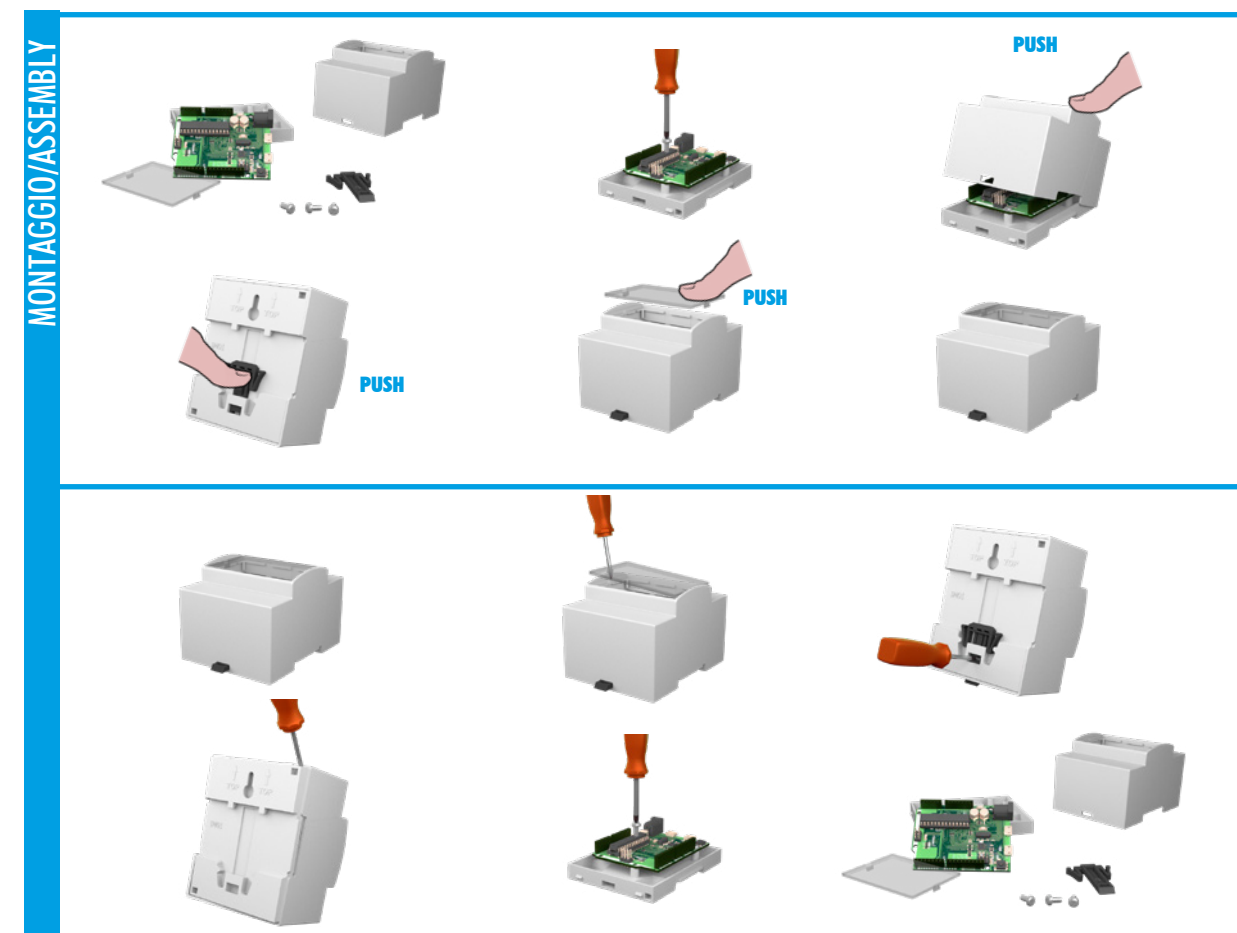

ARDUINO ZERO compact

ARDUINO ZERO compact

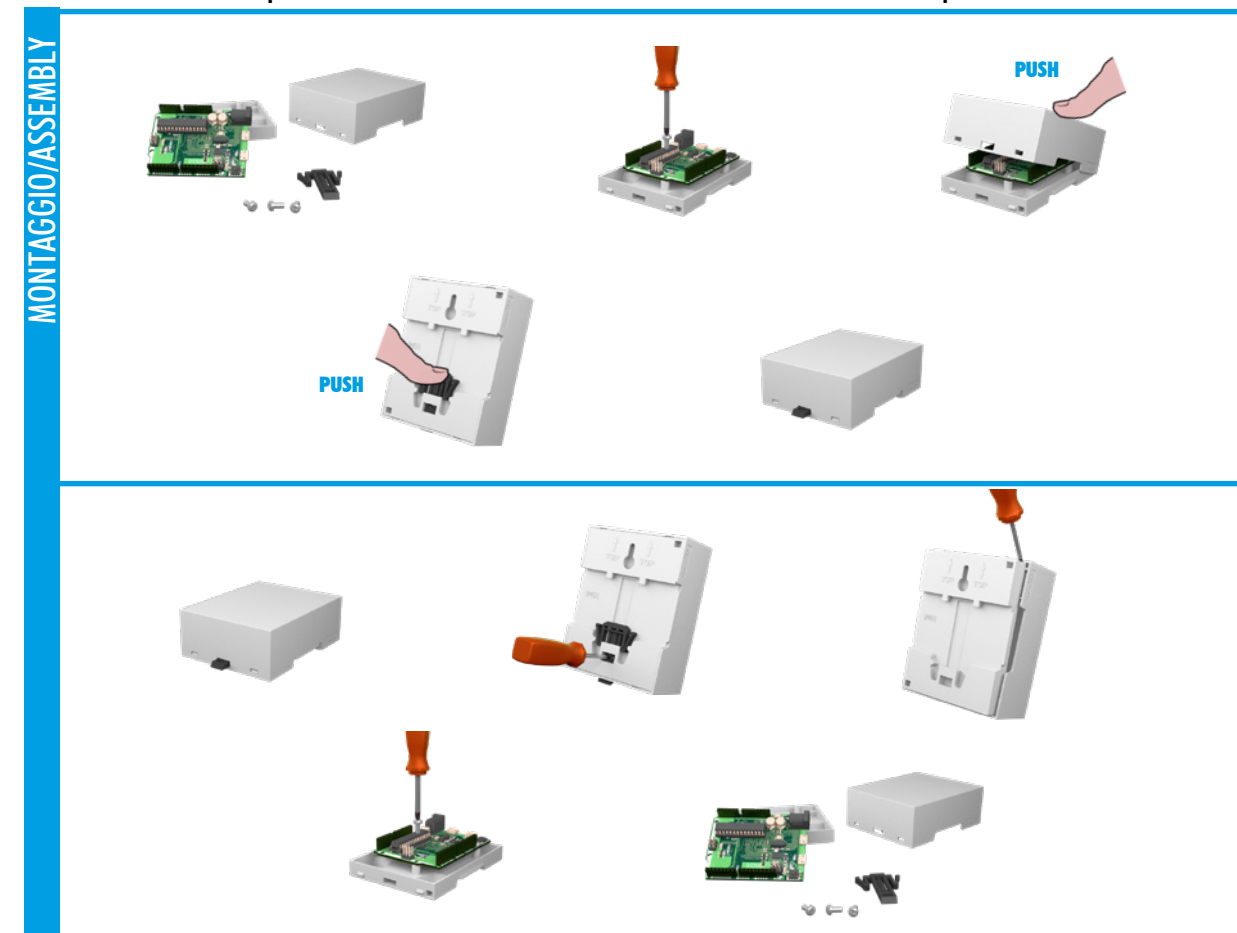

ARDUINO ZERO

CARATTERISTICHE GENERALI

Contenitori per ARDUINO ZERO per guida DIN (EN 60715)

Materiale: PC/ABS autoestinguente UL94V-0
Colore: Grigio

CONTENITORE PER GUIDA DIN (EN 60715)

Italtronic propone una nuova linea di contenitori industriali e per HOME & BUILDING AUTOMATION adatti a contenere le più note schede elettroniche EMBEDDED.

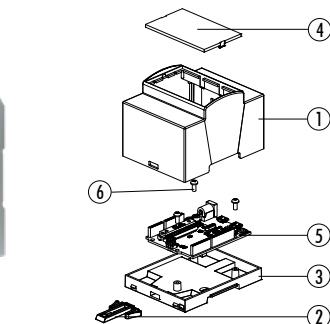

- Descrizione/Description:**
- 1) Corpo contenitore/Body enclosure
 - 2) Gancio/Hook
 - 3) Base/Base
 - 4) Pannello/Panel
 - 5) Circuito stampato*/Pcb*
 - 6) Viti/Screws

* Non incluso / Not included

Contenitore Completo/Complete Enclosure

CODICE / CODE	COLORE / COLOUR	DESCRIZIONE/DESCRIPTION	FORMA/SHAPE
25.0410000.ZERO	Grigio/Grey	Kit 4M XTS Arduino ZERO /4M XTS Arduino ZERO kit	C/C

Composizione Kit: il Kit comprende corpo, base, gancio, pannello trasparente, 3 viti.

Kit composition: kit includes body enclosure, base, hook, transparent panel, 3 screws.

DIMENSIONI B/B DIMENSIONS: 90 mm
DIMENSIONI L/L DIMENSIONS: 74 mm
DIMENSIONI H/H DIMENSIONS: 55 mm

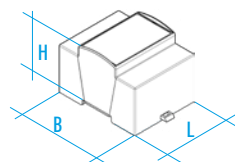

CONFEZIONE N° PCS/KIT: PACKAGING N° PCS/KIT:	PESO DELLA CONFEZIONE: PACKAGING WEIGHT:	MINIMO ACQUISTABILE: MINIMUM ORDER:	PESO DEL PEZZO KIT: KIT WEIGHT:
50	4,5 kg	1	70 g

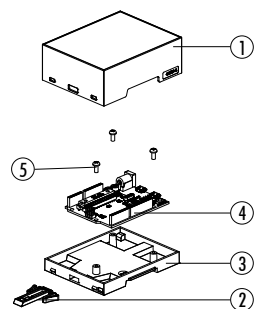

- Descrizione/Description:**
- 1) Corpo contenitore/Body enclosure
 - 2) Gancio/Hook
 - 3) Base/Base
 - 4) Circuito stampato*/Pcb*
 - 5) Viti/Screws

* Non incluso / Not included

Contenitore Completo/Complete Enclosure

CODICE / CODE	COLORE / COLOUR	DESCRIZIONE/DESCRIPTION	FORMA/SHAPE
33.0414000.ZERO	Grigio/Grey	Kit 4M XTS COMPACT Arduino ZERO /4M XTS COMPACT Arduino ZERO kit	C/C

Composizione Kit: il Kit comprende corpo, base, gancio, pannello trasparente, 3 viti.

Kit composition: kit includes body enclosure, base, hook, transparent panel, 3 screws.

DIMENSIONI B/B DIMENSIONS: 90 mm
DIMENSIONI L/L DIMENSIONS: 74 mm
DIMENSIONI H/H DIMENSIONS: 32 mm

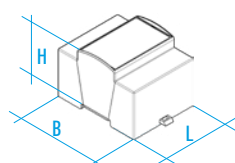

CONFEZIONE N° PCS/KIT: PACKAGING N° PCS/KIT:	PESO DELLA CONFEZIONE: PACKAGING WEIGHT:	MINIMO ACQUISTABILE: MINIMUM ORDER:	PESO DEL PEZZO KIT: KIT WEIGHT:
100	6 kg	1	50 g

TIPO GUIDA DIN/DIN RAIL TYPE: Norme EN 60715/EN 60715 NORM
NORMA CONTENITORE/ENCLOSURE STANDARD: Norme DIN 43880/43880 DIN NORM



ASSEMBLAGGIO/DISASSEMBLAGGIO

BEAGLEBONE BLACK

MONTAGGIO/ASSEMBLY

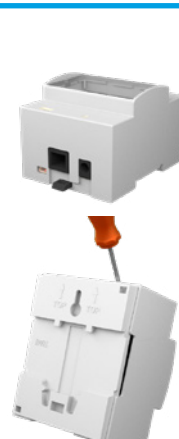
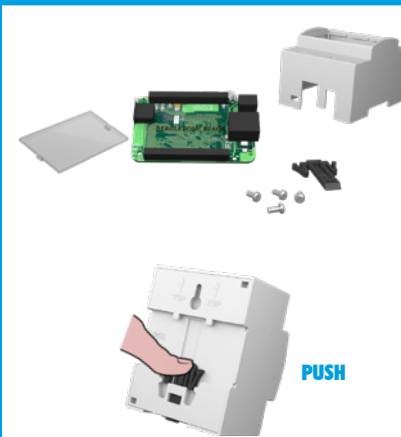

ASSEMBLY/DISASSEMBLY

BEAGLEBONE BLACK

SMONTAGGIO/DISASSEMBLY

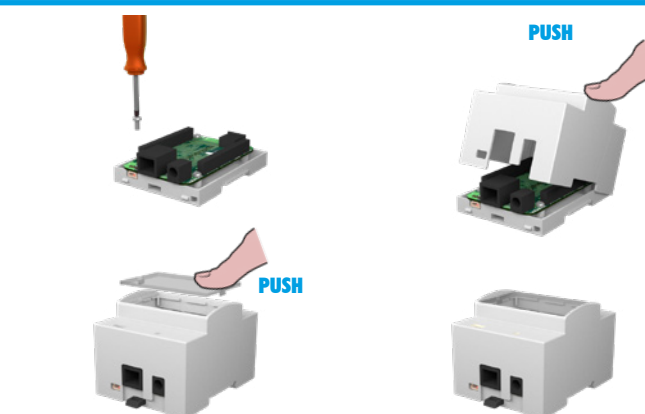

BEAGLEBONE BLACK compact

MONTAGGIO/ASSEMBLY

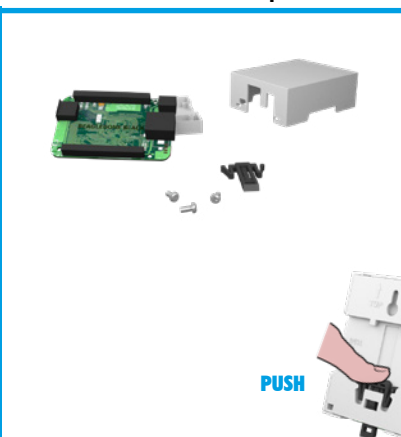

BEAGLEBONE BLACK compact

SMONTAGGIO/DISASSEMBLY

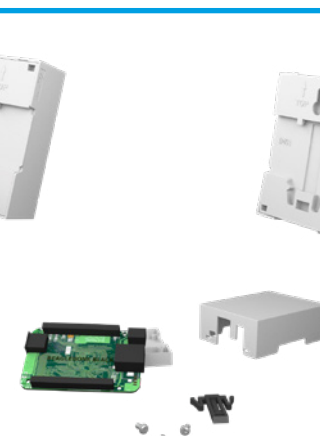
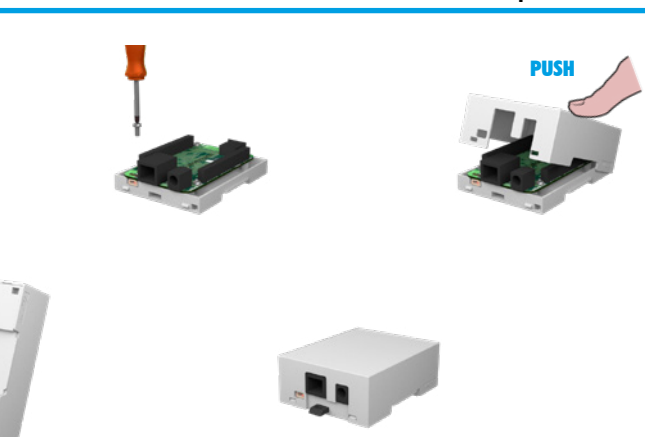

BEAGLEBONE BLACK

CARATTERISTICHE GENERALI

Contenitore per BEAGLEBONE BLACK per guida DIN (EN 60715)

Materiale: PC/ABS autoestinguente UL94V-0
Colore: Grigio

CONTENITORE PER GUIDA DIN (EN 60715)

Italtronic propone una nuova linea di contenitori industriali e per HOME & BUILDING AUTOMATION adatti a contenere le più note schede elettroniche EMBEDDED.

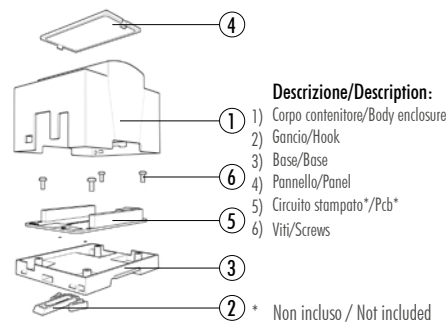

Contenitore Completo/Complete Enclosure

CODICE / CODE	COLORE / COLOUR	DESCRIZIONE/DESCRIPTION	FORMA/SHAPE
25.0410000.BGB	Grigio/Grey	Kit 4M XTS Beaglebone BLACK/4M XTS Beaglebone BLACK kit	C/C

Composizione Kit: il Kit comprende corpo, base, gancio, pannello trasparente, 2 viti.

Kit composition: kit includes body enclosure, base, hook, transparent panel, 2 screws.

DIMENSIONI B/B DIMENSIONS: 90 mm
 DIMENSIONI L/L DIMENSIONS: 71 mm
 DIMENSIONI H/H DIMENSIONS: 55 mm

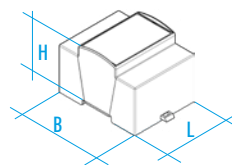

CONFEZIONE N° PCS/KIT: PACKAGING N° PCS/KIT:	PESO DELLA CONFEZIONE: PACKAGING WEIGHT:	MINIMO ACQUISTABILE: MINIMUM ORDER:	PESO DEL PEZZO KIT: KIT WEIGHT:
50	4,5 kg	1	70 g



Contenitore Completo/Complete Enclosure

CODICE / CODE	COLORE / COLOUR	DESCRIZIONE/DESCRIPTION	FORMA/SHAPE
33.0414000.BGB	Grigio/Grey	Kit 4M XTS COMPACT Beaglebone BLACK/4M XTS COMPACT Beaglebone BLACK kit	C/C

Composizione Kit: il Kit comprende corpo, base, gancio, 2 viti.

Kit composition: kit includes body enclosure, base, hook, 2 screws.

DIMENSIONI B/B DIMENSIONS: 90
 DIMENSIONI L/L DIMENSIONS: 71
 DIMENSIONI H/H DIMENSIONS: 32

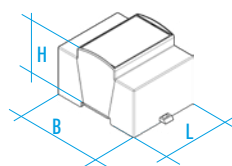

CONFEZIONE N° PCS/KIT: PACKAGING N° PCS/KIT:	PESO DELLA CONFEZIONE: PACKAGING WEIGHT:	MINIMO ACQUISTABILE: MINIMUM ORDER:	PESO DEL PEZZO KIT: KIT WEIGHT:
100	6 kg	1	50 g



TIPO GUIDA DIN/DIN RAIL TYPE: Norme EN 60715/EN 60715 NORM
 NORMA CONTENITORE/ENCLOSURE STANDARD: Norme DIN 43880/43880 DIN NORM

BEAGLEBONE BLACK

CARATTERISTICHE GENERALI

Contenitore per BEAGLEBONE BLACK per guida DIN (EN 60715)

Materiale: PC/ABS autoestinguente UL94V-0
Colore: Grigio

CONTENITORE PER GUIDA DIN (EN 60715)

Italtronic propone una nuova linea di contenitori industriali e per HOME & BUILDING AUTOMATION adatti a contenere le più note schede elettroniche EMBEDDED.

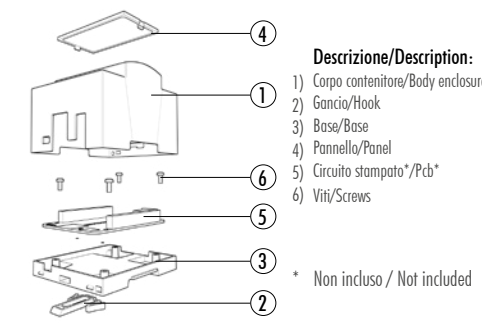

Contenitore Completo/Complete Enclosure

CODICE / CODE	COLORE / COLOUR	DESCRIZIONE/DESCRIPTION	FORMA/SHAPE
25.0610000.BGB	Grigio/Grey	Kit 6M XTS Beaglebone BLACK/6M XTS Beaglebone BLACK kit	C/C

Composizione Kit: il Kit comprende corpo, base, gancio, pannello trasparente, 2 viti.

Kit composition: kit includes body enclosure, base, hook, transparent panel, 2 screws.

DIMENSIONI B/B DIMENSIONS: 90 mm
 DIMENSIONI L/L DIMENSIONS: 106,5 mm
 DIMENSIONI H/H DIMENSIONS: 55 mm

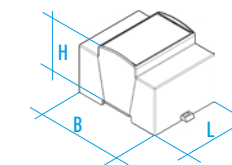

CONFEZIONE N° PCS/KIT: PACKAGING N° PCS/KIT:	PESO DELLA CONFEZIONE: PACKAGING WEIGHT:	MINIMO ACQUISTABILE: MINIMUM ORDER:	PESO DEL PEZZO KIT: KIT WEIGHT:
25	3,25 kg	1	90 g



Contenitore Completo/Complete Enclosure

CODICE / CODE	COLORE / COLOUR	DESCRIZIONE/DESCRIPTION	FORMA/SHAPE
33.0614000.BGB	Grigio/Grey	Kit 6M XTS COMPACT Beaglebone BLACK/6M XTS COMPACT Beaglebone BLACK kit	C/C

Composizione Kit: il Kit comprende corpo, base, gancio, 2 viti.

Kit composition: kit includes body enclosure, base, hook, 2 screws.

DIMENSIONI B/B DIMENSIONS: 90 mm
 DIMENSIONI L/L DIMENSIONS: 106,5 mm
 DIMENSIONI H/H DIMENSIONS: 32

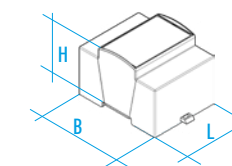

CONFEZIONE N° PCS/KIT: PACKAGING N° PCS/KIT:	PESO DELLA CONFEZIONE: PACKAGING WEIGHT:	MINIMO ACQUISTABILE: MINIMUM ORDER:	PESO DEL PEZZO KIT: KIT WEIGHT:
50	4,75 kg	1	75 g



TIPO GUIDA DIN/DIN RAIL TYPE: Norme EN 60715/EN 60715 NORM
 NORMA CONTENITORE/ENCLOSURE STANDARD: Norme DIN 43880/43880 DIN NORM

ASSEMBLAGGIO/DISASSEMBLAGGIO

ASSEMBLY/DISASSEMBLY

BEAGLEBONE GREEN

BEAGLEBONE GREEN

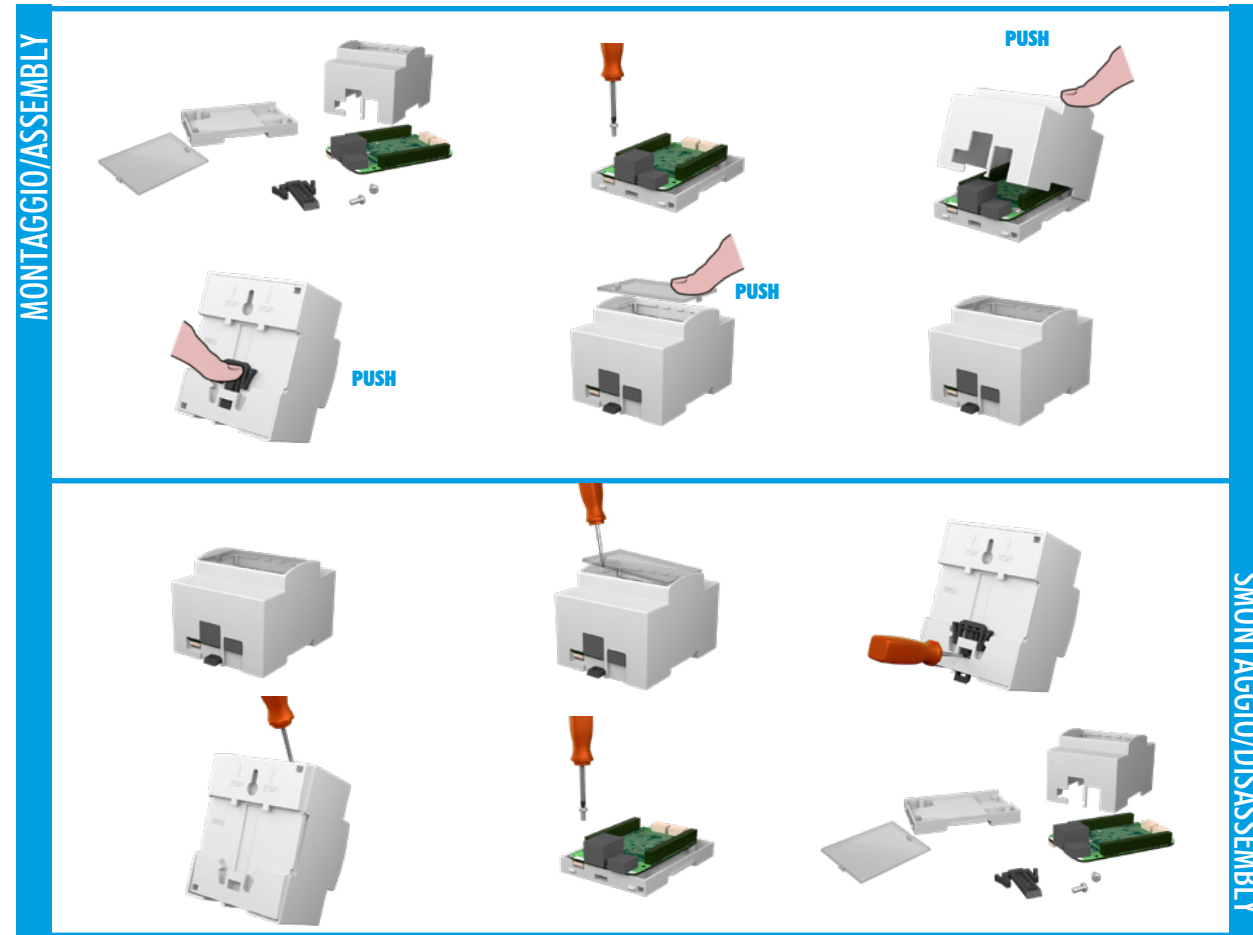

BEAGLEBONE GREEN compact

BEAGLEBONE GREEN compact

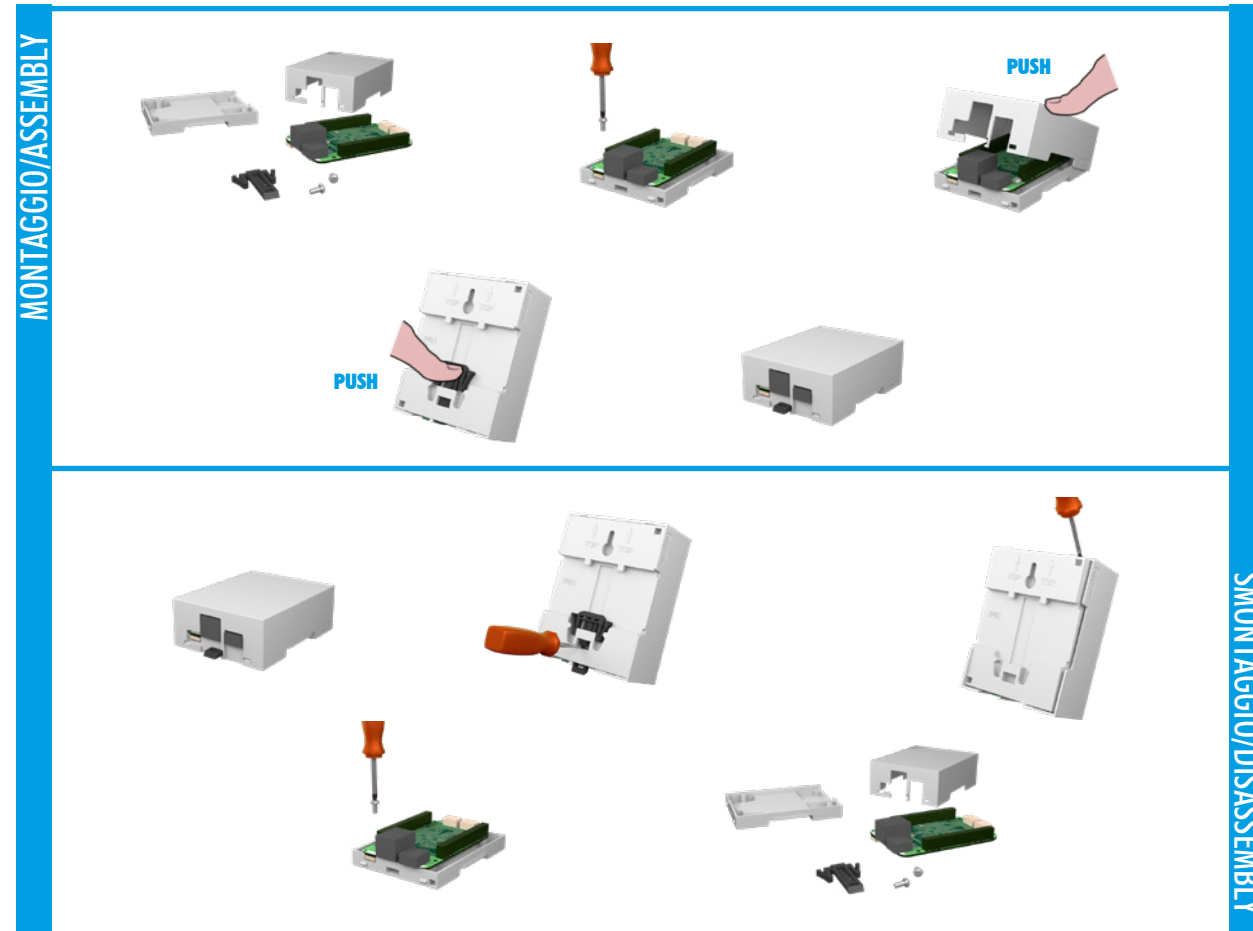

BEAGLEBONE GREEN

CARATTERISTICHE GENERALI

Contenitore per BEAGLEBONE GREEN per guida DIN (EN 60715)

Materiale: PC/ABS autoestinguente UL94V-0
Colore: Grigio

CONTENITORE PER GUIDA DIN (EN 60715)

Italtronic propone una nuova linea di contenitori industriali e per HOME & BUILDING AUTOMATION adatti a contenere le più note schede elettroniche EMBEDDED.



BEAGLEBONE GREEN

GENERAL FEATURES

BEAGLEBONE GREEN for rail din (EN 60715) application.

Material: PC/ABS self-extinguishing UL94V-0
Colour: Grey

DIN RAIL (EN 60715) ENCLOSURE

Italtronic propose a new industrial and HOME & BUILDING AUTOMATION enclosures useful to contain the more famous EMBEDDED electronic boards.

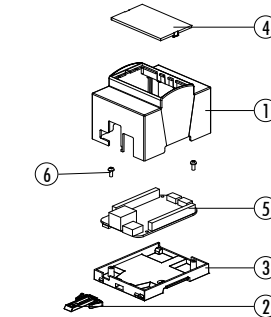

Descrizione/Description:

- 1) Corpo contenitore/Body enclosure
- 2) Gancio/Hook
- 3) Base/Base
- 4) Pannello/Panel
- 5) Circuito stampato*/Pcb*
- 6) Viti/Screws

* Non incluso / Not included

Contenitore Completo/Complete Enclosure

CODICE / CODE	COLORE / COLOUR	DESCRIZIONE/DESCRIPTION	FORMA/SHAPE
25.0410000.BGG	Grigio/Grey	Kit 4M XTS Beaglebone GREEN /4M XTS Beaglebone GREEN kit	C/C

Composizione Kit: il Kit comprende corpo, base, gancio, pannello trasparente, 2 viti.

Kit composition: kit includes body enclosure, base, hook, transparent panel, 2 screws.

DIMENSIONI B/B DIMENSIONS: 90 mm
DIMENSIONI L/L DIMENSIONS: 74 mm
DIMENSIONI H/H DIMENSIONS: 55 mm

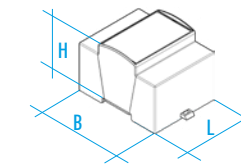

CONFEZIONE N° PCS/KIT: PACKAGING N° PCS/KIT:	50	PESO DELLA CONFEZIONE: PACKAGING WEIGHT:	4,5 kg	MINIMO ACQUISTABILE: MINIMUM ORDER:	1	PESO DEL PEZZO KIT: KIT WEIGHT:	70 g
---	----	---	--------	--	---	------------------------------------	------

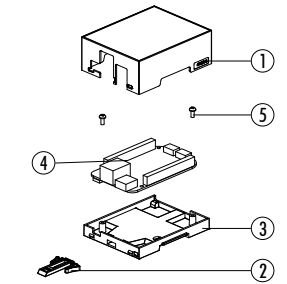
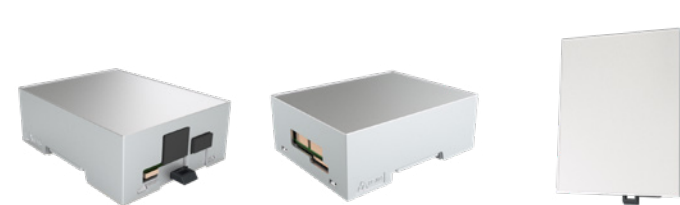

Descrizione/Description:

- 1) Corpo contenitore/Body enclosure
- 2) Gancio/Hook
- 3) Base/Base
- 4) Circuito stampato*/Pcb*
- 5) Viti/Screws

* Non incluso / Not included

Contenitore Completo/Complete Enclosure

CODICE / CODE	COLORE / COLOUR	DESCRIZIONE/DESCRIPTION	FORMA/SHAPE
33.0414000.BGG	Grigio/Grey	Kit 4M XTS COMPACT Beaglebone GREEN /4M XTS COMPACT Beaglebone GREEN kit	C/C

Composizione Kit: il Kit comprende corpo, base, gancio, pannello trasparente, 2 viti.

Kit composition: kit includes body enclosure, base, hook, transparent panel, 2 screws.

DIMENSIONI B/B DIMENSIONS: 90 mm
DIMENSIONI L/L DIMENSIONS: 74 mm
DIMENSIONI H/H DIMENSIONS: 32 mm

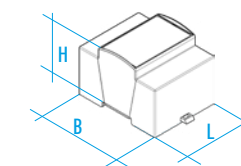

CONFEZIONE N° PCS/KIT: PACKAGING N° PCS/KIT:	100	PESO DELLA CONFEZIONE: PACKAGING WEIGHT:	6,0 kg	MINIMO ACQUISTABILE: MINIMUM ORDER:	1	PESO DEL PEZZO KIT: KIT WEIGHT:	50 g
---	-----	---	--------	--	---	------------------------------------	------

TIPO GUIDA DIN/DIN RAIL TYPE: Norme EN 60715/EN 60715 NORM

NORMA CONTENITORE/ENCLOSURE STANDARD: Norme DIN 43880/43880 DIN NORM



ASSEMBLAGGIO/DISASSEMBLAGGIO

ASSEMBLY/DISASSEMBLY

BEAGLEBONE GREEN

BEAGLEBONE GREEN

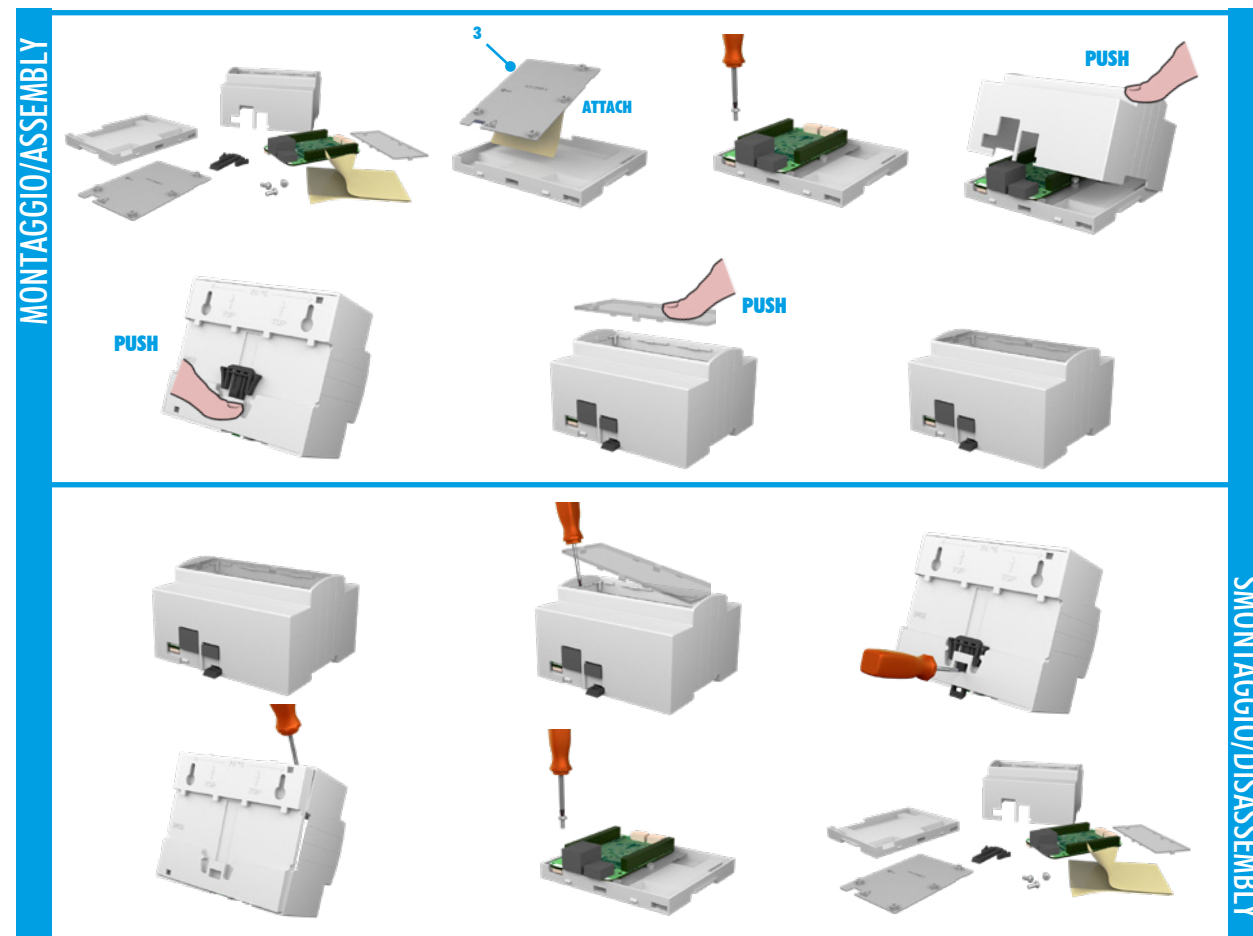

BEAGLEBONE GREEN compact

BEAGLEBONE GREEN compact

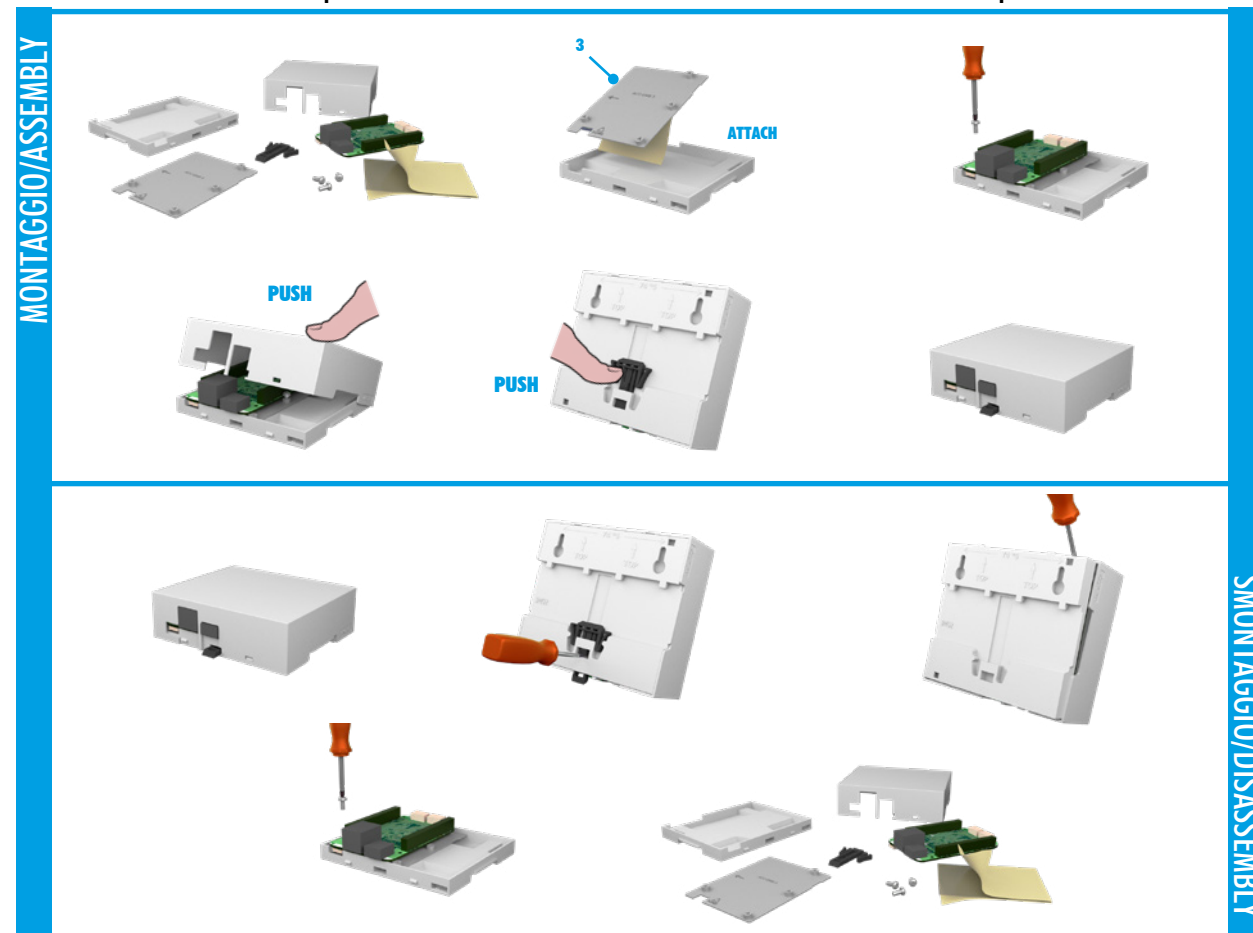

BEAGLEBONE GREEN

CARATTERISTICHE GENERALI

Contenitore per BEAGLEBONE GREEN per guida DIN (EN 60715)

Materiale: PC/ABS autoestinguente UL94V-0
Colore: Grigio

CONTENITORE PER GUIDA DIN (EN 60715)

Italtronic propone una nuova linea di contenitori industriali e per HOME & BUILDING AUTOMATION adatti a contenere le più note schede elettroniche EMBEDDED.

BEAGLEBONE GREEN

GENERAL FEATURES

BEAGLEBONE GREEN for rail din (EN 60715) application.

Material: PC/ABS self-extinguishing UL94V-0
Colour: Grey

DIN RAIL (EN 60715) ENCLOSURE

Italtronic propose a new industrial and HOME & BUILDING AUTOMATION enclosures useful to contain the more famous EMBEDDED electronic boards.

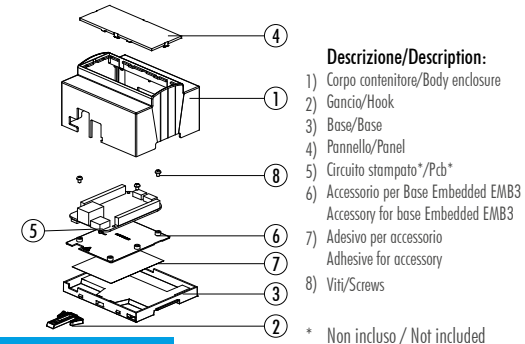

Contenitore Completo/Complete Enclosure

CODICE / CODE	COLORE / COLOUR	DESCRIZIONE/DESCRIPTION	FORMA/SHAPE
25.0610000.BGG	Grigio/Grey	Kit 6M XTS Beaglebone GREEN /6M XTS Beaglebone GREEN kit	C/C

Composizione Kit: il Kit comprende corpo, base, gancio, pannello trasparente, accessorio base embedded, adesivo, 3 viti.

Kit composition: kit includes body enclosure, base, hook, transparent panel, accessory base embedded, adhesive, 3 screws.

DIMENSIONI B/B DIMENSIONS: 90 mm
DIMENSIONI L/L DIMENSIONS: 106,5 mm
DIMENSIONI H/H DIMENSIONS: 55 mm

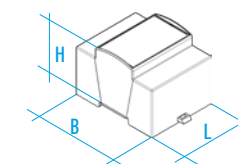

CONFEZIONE N° PCS/KIT: PACKAGING N° PCS/KIT:	25	PESO DELLA CONFEZIONE: PACKAGING WEIGHT:	3,25 kg	MINIMO ACQUISTABILE: MINIMUM ORDER:	1	PESO DEL PEZZO KIT: KIT WEIGHT:	95 g
---	----	---	---------	--	---	------------------------------------	------

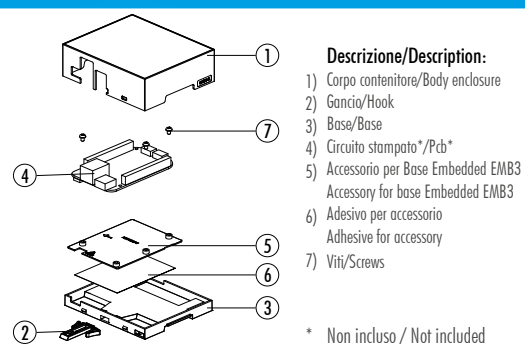

Contenitore Completo/Complete Enclosure

CODICE / CODE	COLORE / COLOUR	DESCRIZIONE/DESCRIPTION	FORMA/SHAPE
33.0614000.BGG	Grigio/Grey	Kit 6M XTS COMPACT Beaglebone GREEN /6M XTS COMPACT Beaglebone GREEN kit	C/C

Composizione Kit: il Kit comprende corpo, base, gancio, accessorio base embedded, adesivo, 3 viti.

Kit composition: kit includes body enclosure, base, hook, accessory base embedded, adhesive, 3 screws.

DIMENSIONI B/B DIMENSIONS: 90 mm
DIMENSIONI L/L DIMENSIONS: 106,5 mm
DIMENSIONI H/H DIMENSIONS: 32 mm

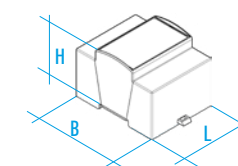

CONFEZIONE N° PCS/KIT: PACKAGING N° PCS/KIT:	50	PESO DELLA CONFEZIONE: PACKAGING WEIGHT:	5,0 kg	MINIMO ACQUISTABILE: MINIMUM ORDER:	1	PESO DEL PEZZO KIT: KIT WEIGHT:	80 g
---	----	---	--------	--	---	------------------------------------	------

TIPO GUIDA DIN/DIN RAIL TYPE: Norme EN 60715/EN 60715 NORM
NORMA CONTENITORE/ENCLOSURE STANDARD: Norme DIN 43880/43880 DIN NORM



ASSEMBLAGGIO/DISASSEMBLAGGIO

ASSEMBLY/DISASSEMBLY

BEAGLEBONE GREEN WIRELESS

BEAGLEBONE GREEN WIRELESS

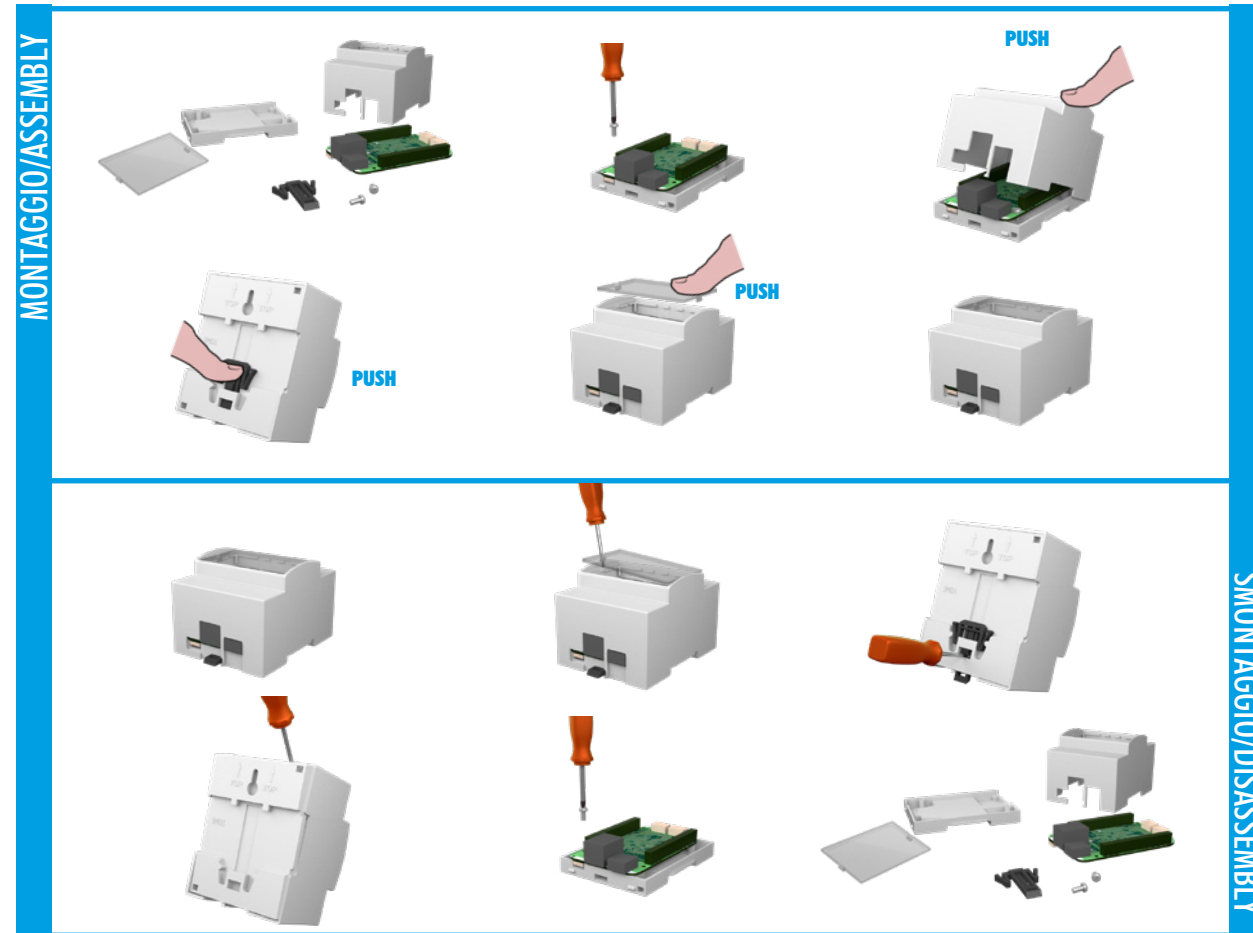

BEAGLEBONE GREEN WIRELESS compact

BEAGLEBONE GREEN WIRELESS compact

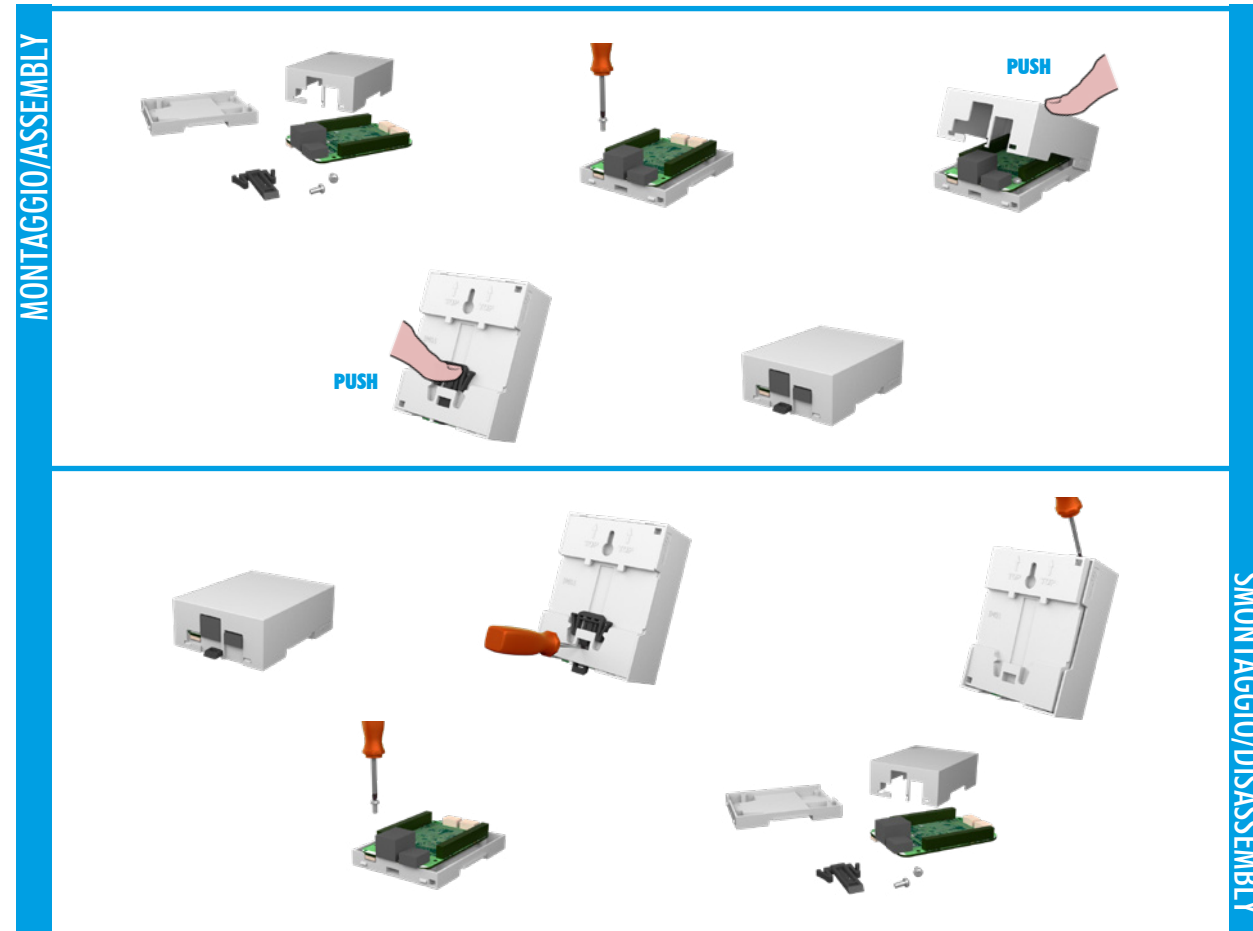

BEAGLEBONE GREEN WIRELESS

CARATTERISTICHE GENERALI
Contenitore per BEAGLEBONE GREEN WIRELESS per guida DIN (EN 60715)
 Materiale: PC/ABS autoestinguente UL94V-0
 Colore: Grigio

CONTENITORE PER GUIDA DIN (EN 60715)
 Italtronic propone una nuova linea di contenitori industriali e per HOME & BUILDING AUTOMATION adatti a contenere le più note schede elettroniche EMBEDDED.



BEAGLEBONE GREEN WIRELESS

GENERAL FEATURES
BEAGLEBONE GREEN WIRELESS for rail din (EN 60715) application.
 Material: PC/ABS self-extinguishing UL94V-0
 Colour: Grey

DIN RAIL (EN 60715) ENCLOSURE
 Italtronic propose a new industrial and HOME & BUILDING AUTOMATION enclosures useful to contain the more famous EMBEDDED electronic boards.

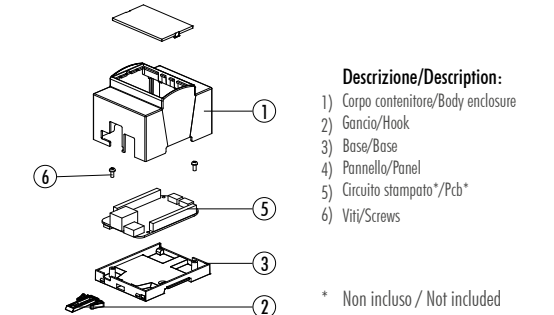

Contenitore Completo/Complete Enclosure

CODICE / CODE	COLORE / COLOUR	DESCRIZIONE/DESCRIPTION	FORMA/SHAPE
25.0410000.BGW	Grigio/Grey	Kit 4M XTS Beaglebone GREEN WIRELESS/4M XTS Beaglebone GREEN WIRELESS kit	C/C

Composizione Kit: il Kit comprende corpo, base, gancio, pannello trasparente, 2 viti.

Kit composition: kit includes body enclosure, base, hook, transparent panel, 2 screws.

DIMENSIONI B/B DIMENSIONS: 90 mm
 DIMENSIONI L/L DIMENSIONS: 74 mm
 DIMENSIONI H/H DIMENSIONS: 55 mm

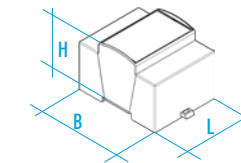

CONFEZIONE N° PCS/KIT: PACKAGING N° PCS/KIT:	50	PESO DELLA CONFEZIONE: PACKAGING WEIGHT:	4,5 kg	MINIMO ACQUISTABILE: MINIMUM ORDER:	1	PESO DEL PEZZO KIT: KIT WEIGHT:	70 g
--	----	--	--------	---	---	---	------

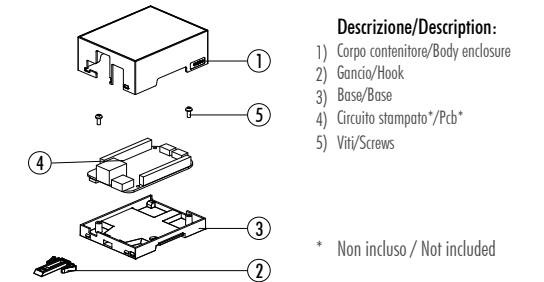

Contenitore Completo/Complete Enclosure

CODICE / CODE	COLORE / COLOUR	DESCRIZIONE/DESCRIPTION	FORMA/SHAPE
33.0414000.BGW	Grigio/Grey	Kit 4M XTS COMPACT Beaglebone GREEN WIRELESS 4M XTS COMPACT Beaglebone GREEN WIRELESS kit	C/C

Composizione Kit: il Kit comprende corpo, base, gancio, 2 viti.

Kit composition: kit includes body enclosure, base, hook, 2 screws.

DIMENSIONI B/B DIMENSIONS: 90 mm
 DIMENSIONI L/L DIMENSIONS: 74 mm
 DIMENSIONI H/H DIMENSIONS: 32 mm

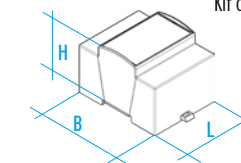

CONFEZIONE N° PCS/KIT: PACKAGING N° PCS/KIT:	100	PESO DELLA CONFEZIONE: PACKAGING WEIGHT:	6,0 kg	MINIMO ACQUISTABILE: MINIMUM ORDER:	1	PESO DEL PEZZO KIT: KIT WEIGHT:	50 g
--	-----	--	--------	---	---	---	------

TIPO GUIDA DIN/DIN RAIL TYPE: Norme EN 60715/EN 60715 NORM
 NORMA CONTENITORE/ENCLOSURE STANDARD: Norme DIN 43880/43880 DIN NORM



ASSEMBLAGGIO/DISASSEMBLAGGIO

BEAGLEBONE GREEN WIRELESS

MONTAGGIO/ASSEMBLY

SMONTAGGIO/DISASSEMBLY

ASSEMBLY/DISASSEMBLY

BEAGLEBONE GREEN WIRELESS

BEAGLEBONE GREEN

WIRELESS

CARATTERISTICHE GENERALI

Contenitore per BEAGLEBONE GREEN WIRELESS per guida DIN (EN 60715)

Materiale: PC/ABS autoestinguente UL94V-0
Colore: Grigio

CONTENITORE PER GUIDA DIN (EN 60715)

Italtronic propone una nuova linea di contenitori industriali e per HOME & BUILDING AUTOMATION adatti a contenere le più note schede elettroniche EMBEDDED.



BEAGLEBONE GREEN

WIRELESS

GENERAL FEATURES

BEAGLEBONE GREEN WIRELESS for rail din (EN 60715) application.

Material: PC/ABS self-extinguishing UL94V-0
Colour: Grey

DIN RAIL (EN 60715) ENCLOSURE

Italtronic propose a new industrial and HOME & BUILDING AUTOMATION enclosures useful to contain the more famous EMBEDDED electronic boards.

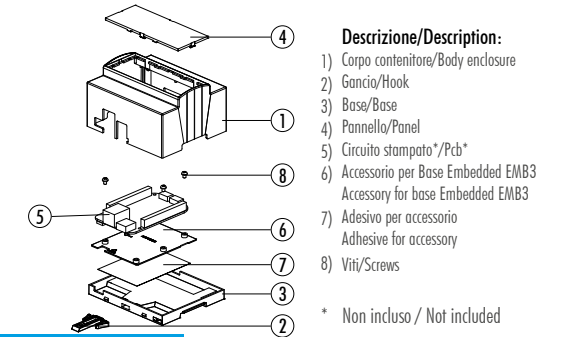

Contenitore Completo/Complete Enclosure

CODICE / CODE	COLORE / COLOUR	DESCRIZIONE/DESCRIPTION	FORMA/SHAPE
25.061000.BGW	Grigio/Grey	Kit 6M XTS Beaglebone GREEN WIRELESS/6M XTS Beaglebone GREEN WIRELESS kit	C/C

Composizione Kit: il Kit comprende corpo, base, gancio, pannello trasparente, accessorio base embedded, adesivo, 3 viti.

Kit composition: kit includes body enclosure, base, hook, transparent panel, accessory base embedded, adhesive, 3 screws.

DIMENSIONI B/B DIMENSIONS: 90 mm
DIMENSIONI L/L DIMENSIONS: 106,5 mm
DIMENSIONI H/H DIMENSIONS: 55 mm

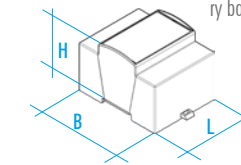

BEAGLEBONE GREEN WIRELESS compact

MONTAGGIO/ASSEMBLY

SMONTAGGIO/DISASSEMBLY

BEAGLEBONE GREEN WIRELESS compact

CONFEZIONE N° PCS/KIT: 25	PESO DELLA CONFEZIONE: 3,5 kg	MINIMO ACQUISTABILE: 1	PESO DEL PEZZO KIT: 95 g
PACKAGING N° PCS/KIT:	PACKAGING WEIGHT:	MINIMUM ORDER:	KIT WEIGHT:

Contenitore Completo/Complete Enclosure

CODICE / CODE	COLORE / COLOUR	DESCRIZIONE/DESCRIPTION	FORMA/SHAPE
33.0614000.BGW	Grigio/Grey	Kit 6M XTS COMPACT Beaglebone GREEN WIRELESS 6M XTS COMPACT Beaglebone GREEN WIRELESS kit	C/C

Composizione Kit: il Kit comprende corpo, base, gancio, accessorio base embedded, adesivo, 3 viti.

Kit composition: kit includes body enclosure, base, hook, accessory base embedded, adhesive, 3 screws.

DIMENSIONI B/B DIMENSIONS: 90 mm
DIMENSIONI L/L DIMENSIONS: 106,5 mm
DIMENSIONI H/H DIMENSIONS: 32 mm

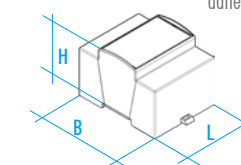

CONFEZIONE N° PCS/KIT: 50	PESO DELLA CONFEZIONE: 5,0 kg	MINIMO ACQUISTABILE: 1	PESO DEL PEZZO KIT: 80 g
PACKAGING N° PCS/KIT:	PACKAGING WEIGHT:	MINIMUM ORDER:	KIT WEIGHT:

TIPO GUIDA DIN/DIN RAIL TYPE: Norme EN 60715/EN 60715 NORM
NORMA CONTENITORE/ENCLOSURE STANDARD: Norme DIN 43880/43880 DIN NORM



RASPBERRY PI

RASPBERRY PI

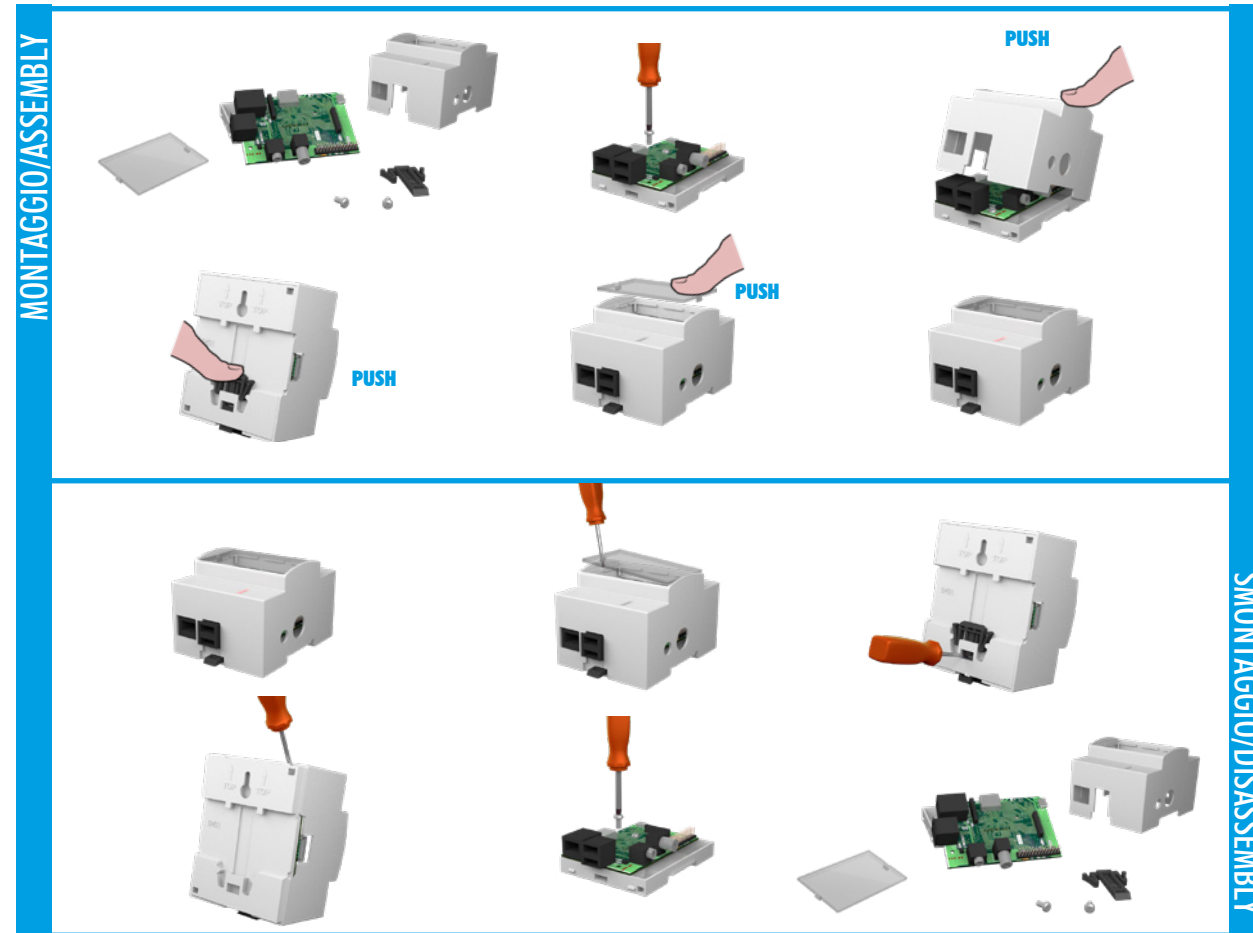

EMBEDDED BOX

MONTAGGIO/ASSEMBLY

SMONTAGGIO/DISASSEMBLY



RASPBERRY PI
GENERAL FEATURES
RASPBERRY PI for rail din (EN 60715) applica-
tion.

Material: PC/ABS self-extinguishing UL94V-0
Colour: Grey

DIN RAIL (EN 60715) ENCLOSURE

Italtronic propose a new industrial and HOME & BUILDING AUTOMATION enclosures useful to contain the more famous EMBEDDED electronic boards.

RASPBERRY PI
CARATTERISTICHE GENERALI
Contenitore per RASPBERRY PI per guida DIN
(EN 60715)

Material: PC/ABS autoestinguente UL94V-0
Colore: Grigio

CONTENITORE PER GUIDA DIN (EN 60715)

Italtronic propone una nuova linea di contenitori industriali e per HOME & BUILDING AUTOMATION adatti a contenere le più note schede elettroniche EMBEDDED.



- Descrizione/Description:
- 1) Corpo contenitore/Body enclosure
 - 2) Gancio/Hook
 - 3) Base/Base
 - 4) Pannello/Panel
 - 5) Circuito stampato*/Pcb*
 - 6) Viti/Screws

* Non incluso / Not included

Contenitore Completo/Complete Enclosure

CODICE / CODE	COLORE / COLOUR	DESCRIZIONE/DESCRIPTION	FORMA/SHAPE
25.041.0000.RPI	Grigio/Grey	Kit 4M XTS Raspberry PI / 4M XTS Raspberry PI kit	C/C

Composizione Kit: il Kit comprende corpo, base, gancio, pannello trasparente, 2 viti.

Kit composition: kit includes body enclosure, base, hook, transparent panel, 2 screws.

DIMENSIONI B/B DIMENSIONS: 90 mm
DIMENSIONI L/L DIMENSIONS: 71 mm
DIMENSIONI H/H DIMENSIONS: 55 mm

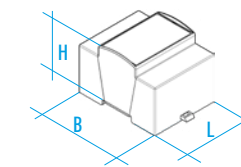

CONFEZIONE N° PCS/KIT: PACKAGING N° PCS/KIT:	50	PESO DELLA CONFEZIONE: PACKAGING WEIGHT:	4,5 kg	MINIMO ACQUISTABILE: MINIMUM ORDER:	1	PESO DEL PEZZO KIT: KIT WEIGHT:	70 g
---	----	---	--------	--	---	------------------------------------	------

TIPO GUIDA DIN/DIN RAIL TYPE: Norme EN 60715/EN 60715 NORM
NORMA CONTENITORE/ENCLOSURE STANDARD: Norme DIN 43880/43880 DIN NORM



EMBEDDED BOX





RASPERRY PI B+ GENERAL FEATURES
RASPERRY PI B+ for rail din (EN 60715) application.

Material: PC/ABS self-extinguishing UL94V-0
Colour: Grey

DIN RAIL (EN 60715) ENCLOSURE

Italtronic propose a new industrial and HOME & BUILDING AUTOMATION enclosures useful to contain the more famous EMBEDDED electronic boards.

RASPERRY PI B+ CARATTERISTICHE GENERALI
Contenitore per RASPERRY PI B+ per guida DIN (EN 60715)

Materiale: PC/ABS autoestinguente UL94V-0
Colore: Grigio

CONTENITORE PER GUIDA DIN (EN 60715)

Italtronic propone una nuova linea di contenitori industriali e per HOME & BUILDING AUTOMATION adatti a contenere le più note schede elettroniche EMBEDDED.



Contenitore Completo/Complete Enclosure

CODICE / CODE	COLORE / COLOUR	DESCRIZIONE/DESCRIPTION	FORMA/SHAPE
25.0410000.RMB	Grigio/Grey	Kit 4M XTS Raspberry PI B+ /4M XTS Raspberry PI B+ kit	C/C

Composizione Kit: il Kit comprende corpo, base, gancio, pannello trasparente, 2 viti

Kit composition: kit includes body enclosure, base, hook, transparent panel, 2 screws.

DIMENSIONI B/B DIMENSIONS: 90 mm
 DIMENSIONI L/L DIMENSIONS: 71 mm
 DIMENSIONI H/H DIMENSIONS: 55 mm

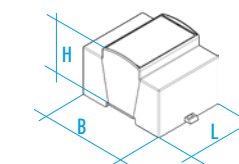

CONFEZIONE N° PCS/KIT: PACKAGING N° PCS/KIT:	PESO DELLA CONFEZIONE: PACKAGING WEIGHT:	MINIMO ACQUISTABILE: MINIMUM ORDER:	PESO DEL PEZZO KIT: KIT WEIGHT:
50	4,5 kg	1	70 g



Contenitore Completo/Complete Enclosure

CODICE / CODE	COLORE / COLOUR	DESCRIZIONE/DESCRIPTION	FORMA/SHAPE
33.0414000.RMB	Grigio/Grey	Kit 4M XTS COMPACT Raspberry PI B+ /4M XTS COMPACT Raspberry PI B+ kit	C/C

Composizione Kit: il Kit comprende corpo, base, gancio, 2 viti

Kit composition: kit includes body enclosure, base, hook, 2 screws.

DIMENSIONI B/B DIMENSIONS: 90 mm
 DIMENSIONI L/L DIMENSIONS: 71 mm
 DIMENSIONI H/H DIMENSIONS: 32 mm

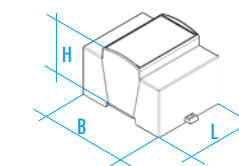

CONFEZIONE N° PCS/KIT: PACKAGING N° PCS/KIT:	PESO DELLA CONFEZIONE: PACKAGING WEIGHT:	MINIMO ACQUISTABILE: MINIMUM ORDER:	PESO DEL PEZZO KIT: KIT WEIGHT:
100	6,0 kg	1	50 g

TIPO GUIDA DIN/DIN RAIL TYPE: Norme EN 60715/EN 60715 NORM
 NORMA CONTENITORE/ENCLOSURE STANDARD: Norme DIN 43880/43880 DIN NORM



ASSEMBLAGGIO/DISASSEMBLAGGIO

ASSEMBLY/DISASSEMBLY

RASPERRY PI B +

RASPERRY PI B +

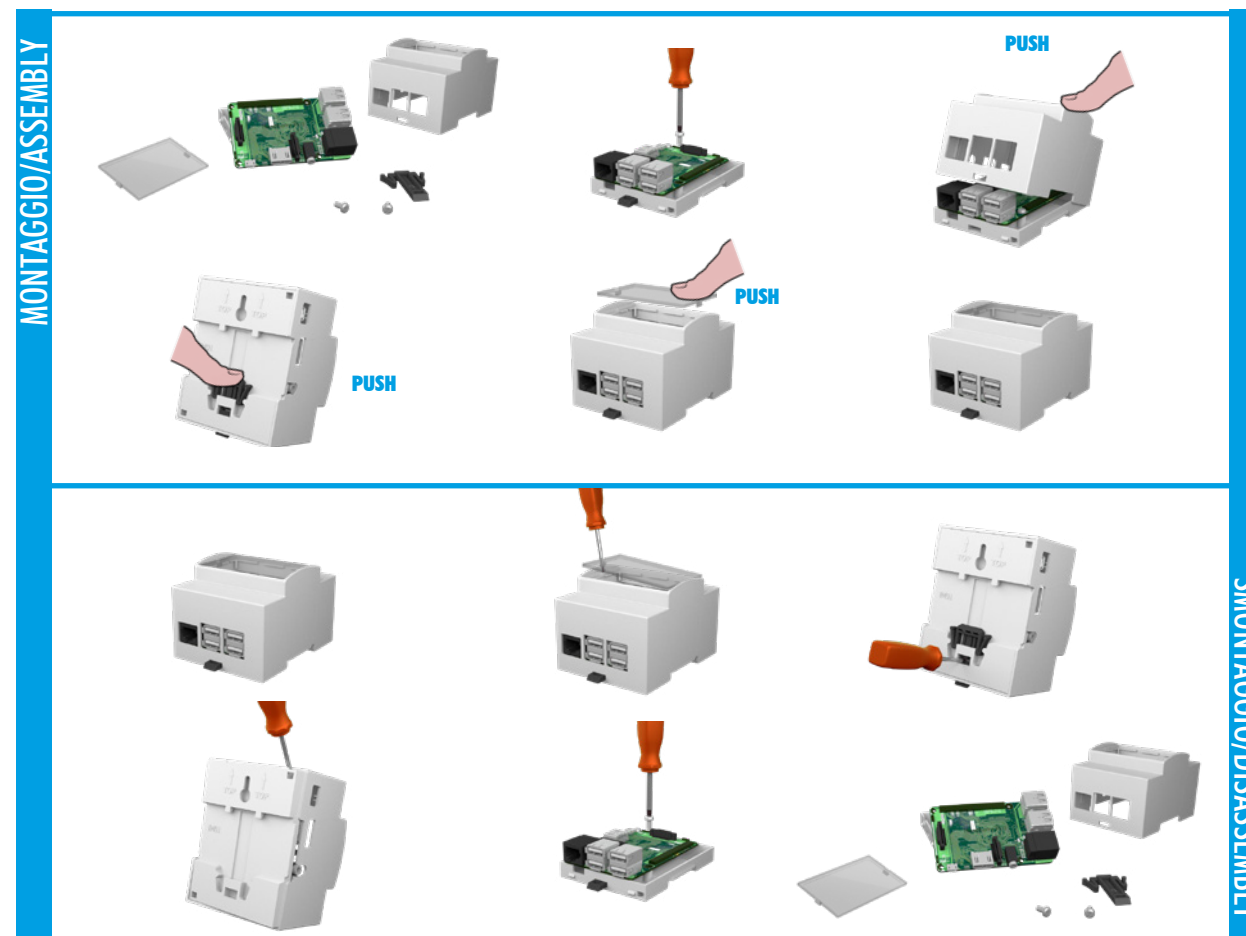

RASPERRY PI B + compact

RASPERRY PI B + compact

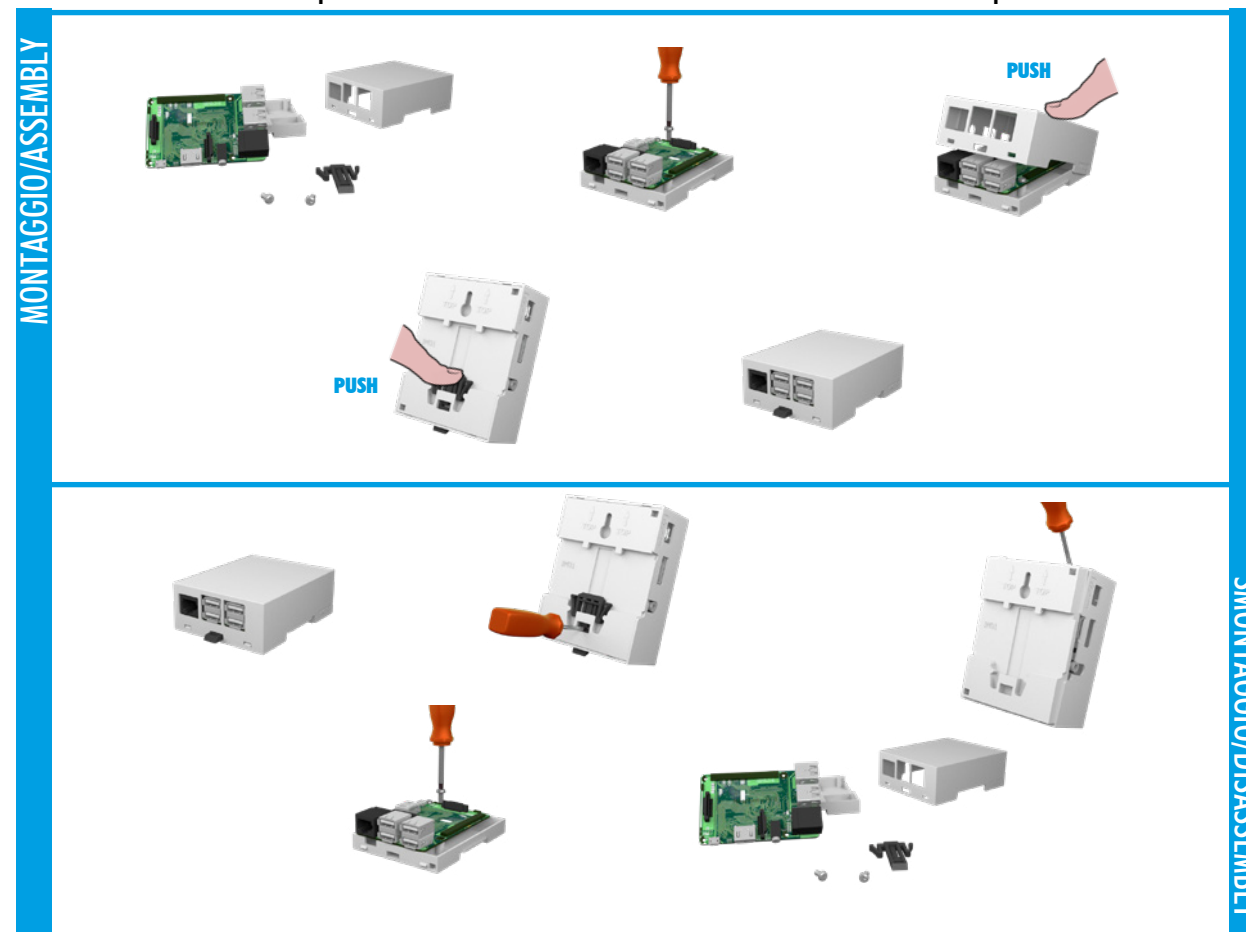

MONTAGGIO/ASSEMBLY

SMONTAGGIO/DISASSEMBLY

MONTAGGIO/ASSEMBLY

SMONTAGGIO/DISASSEMBLY





ASSEMBLAGGIO/DISASSEMBLAGGIO

ASSEMBLY/DISASSEMBLY

RASPERRY PI B +

RASPERRY PI B +

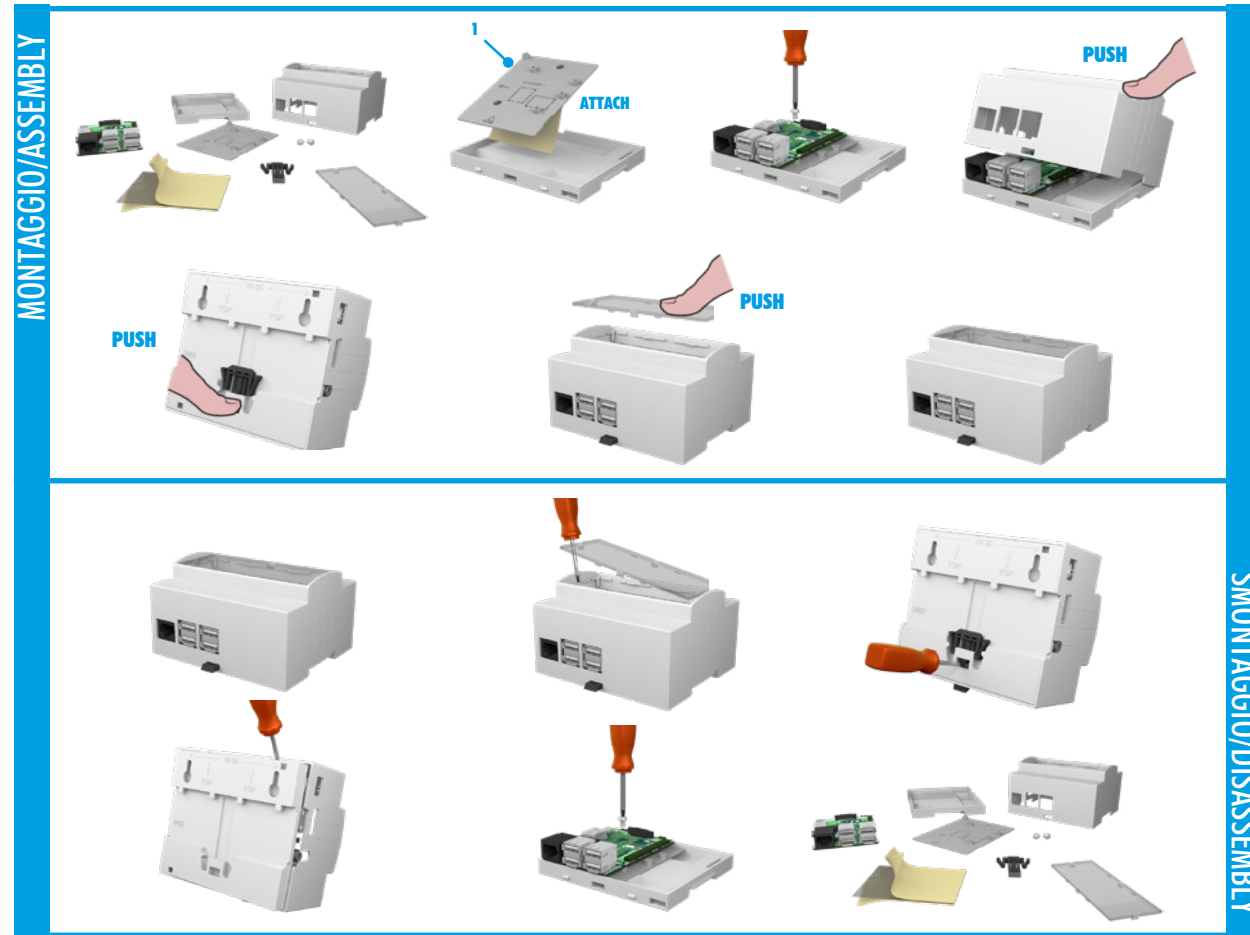

RASPERRY PI B + compact

RASPERRY PI B + compact

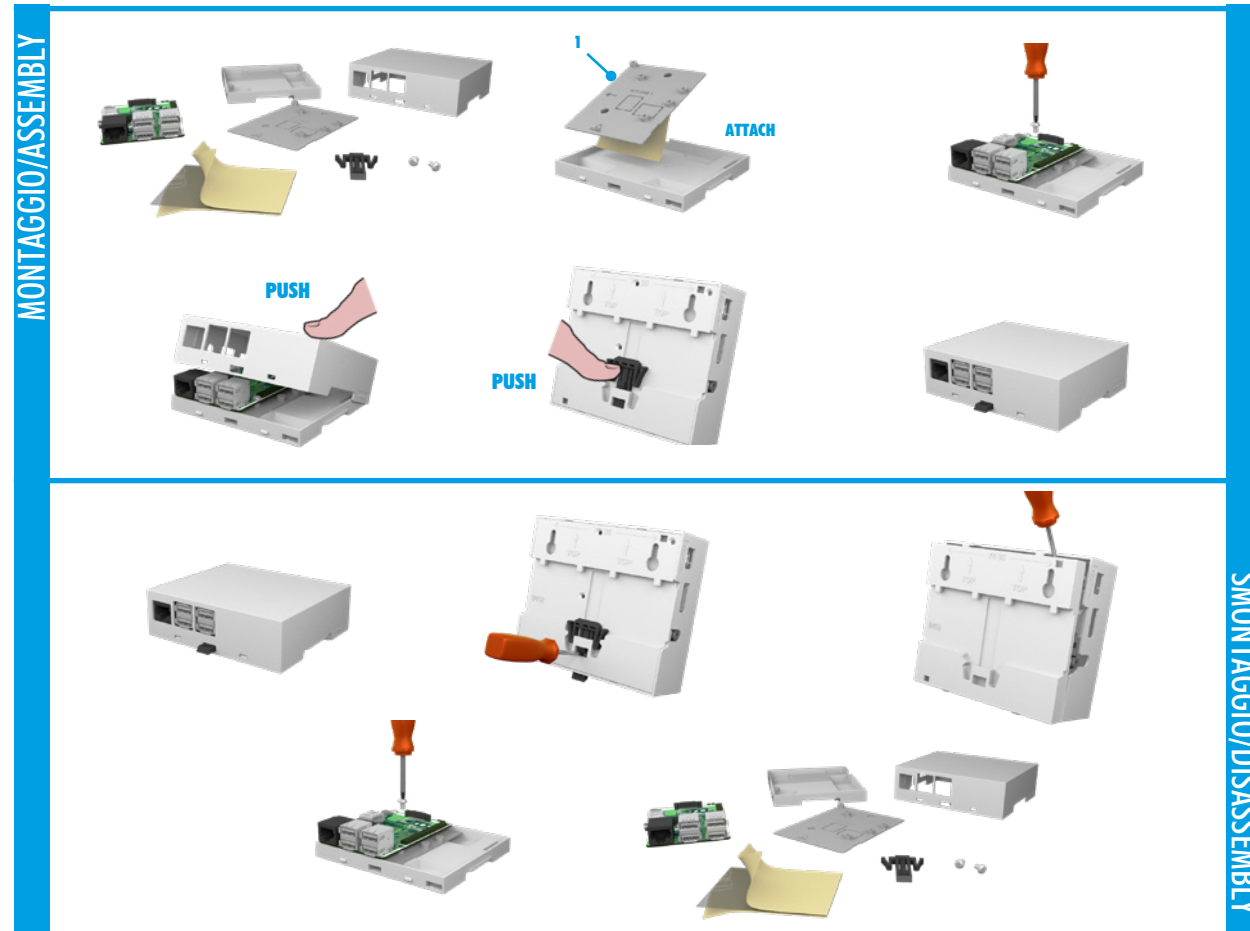

RASPERRY PI B+
CARATTERISTICHE GENERALI
Contenitore per RASPERRY PI B+ per guida
DIN (EN 60715)

Materiale: PC/ABS autoestinguente UL94V-0
Colore: Grigio

CONTENITORE PER GUIDA DIN (EN 60715)

Italtronic propone una nuova linea di contenitori industriali e per HOME & BUILDING AUTOMATION adatti a contenere le più note schede elettroniche EMBEDDED.



RASPERRY PI B+
GENERAL FEATURES
RASPERRY PI B+ for rail din (EN 60715)
application.

Material: PC/ABS self-extinguishing UL94V-0
Colour: Grey

DIN RAIL (EN 60715) ENCLOSURE

Italtronic propose a new industrial and HOME & BUILDING AUTOMATION enclosures useful to contain the more famous EMBEDDED electronic boards.

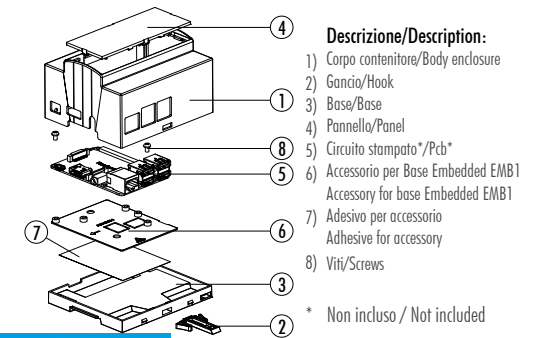

Contenitore Completo/Complete Enclosure

CODICE / CODE	COLORE / COLOUR	DESCRIZIONE/DESCRIPTION	FORMA/SHAPE
25.0610000.RMB	Grigio/Grey	Kit 6M XTS Raspberry PI B+ /6M XTS Raspberry PI B+ kit	C/C

Composizione Kit: il Kit comprende corpo, base, gancio, pannello trasp., accessorio base embedded, adesivo, 3 viti.

Kit composition: kit includes body enclosure, base, hook, transparent panel, accessory for base embedded, adhesive for accessory, 3 screws.

DIMENSIONI B/B DIMENSIONS: 90 mm
 DIMENSIONI L/L DIMENSIONS: 106,5 mm
 DIMENSIONI H/H DIMENSIONS: 55 mm

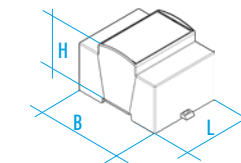

CONFEZIONE N° PCS/KIT: PACKAGING N° PCS/KIT:	25	PESO DELLA CONFEZIONE: PACKAGING WEIGHT:	3,25 kg	MINIMO ACQUISTABILE: MINIMUM ORDER:	1	PESO DEL PEZZO KIT: KIT WEIGHT:	90 g
---	----	---	---------	--	---	------------------------------------	------

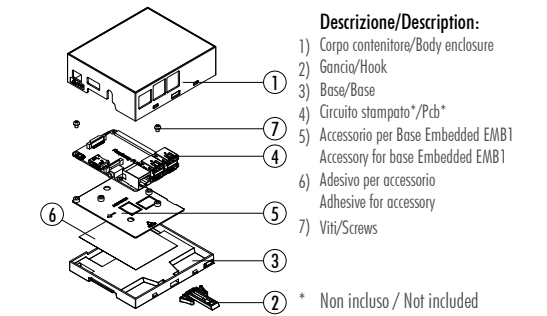

Contenitore Completo/Complete Enclosure

CODICE / CODE	COLORE / COLOUR	DESCRIZIONE/DESCRIPTION	FORMA/SHAPE
33.0614000.RMB	Grigio/Grey	Kit 6M XTS COMPACT Raspberry PI B+ /6M XTS COMPACT Raspberry PI B+ kit	C/C

Composizione Kit: il Kit comprende corpo, base, gancio, accessorio base embedded, adesivo, 3 viti.

Kit composition: kit includes body enclosure, base, hook, accessory for base embedded, adhesive for accessory, 3 screws.

DIMENSIONI B/B DIMENSIONS: 90 mm
 DIMENSIONI L/L DIMENSIONS: 106,5 mm
 DIMENSIONI H/H DIMENSIONS: 32 mm

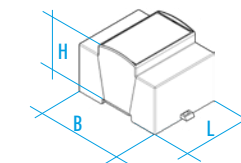

CONFEZIONE N° PCS/KIT: PACKAGING N° PCS/KIT:	50	PESO DELLA CONFEZIONE: PACKAGING WEIGHT:	4,75 kg	MINIMO ACQUISTABILE: MINIMUM ORDER:	1	PESO DEL PEZZO KIT: KIT WEIGHT:	75 g
---	----	---	---------	--	---	------------------------------------	------

TIPO GUIDA DIN/DIN RAIL TYPE: Norme EN 60715/EN 60715 NORM
 NORMA CONTENITORE/ENCLOSURE STANDARD: Norme DIN 43880/43880 DIN NORM





ASSEMBLAGGIO/DISASSEMBLAGGIO

ASSEMBLY/DISASSEMBLY

RASPBERY PI 3

RASPBERY PI 3

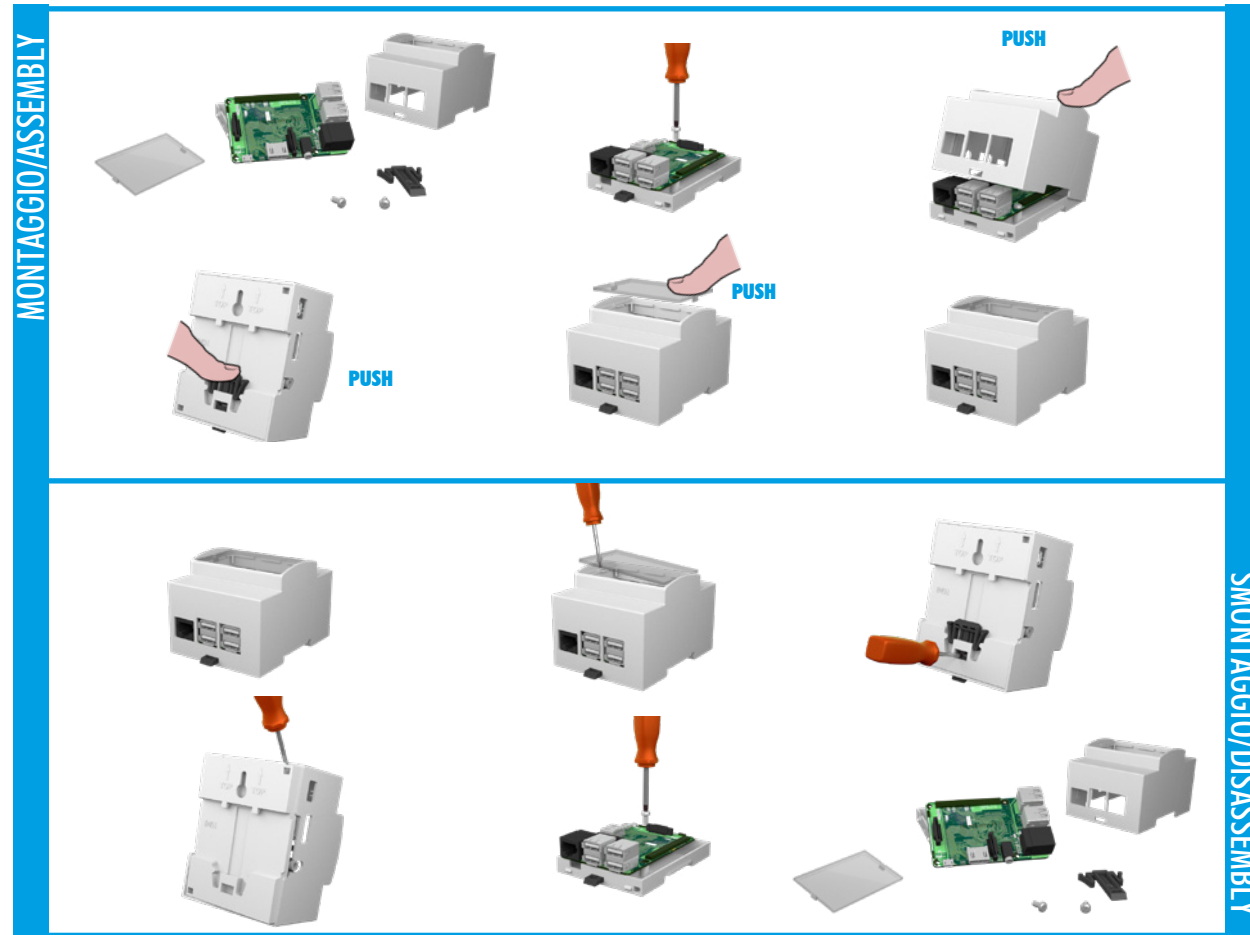

RASPBERY PI 3 compact

RASPBERY PI 3 compact

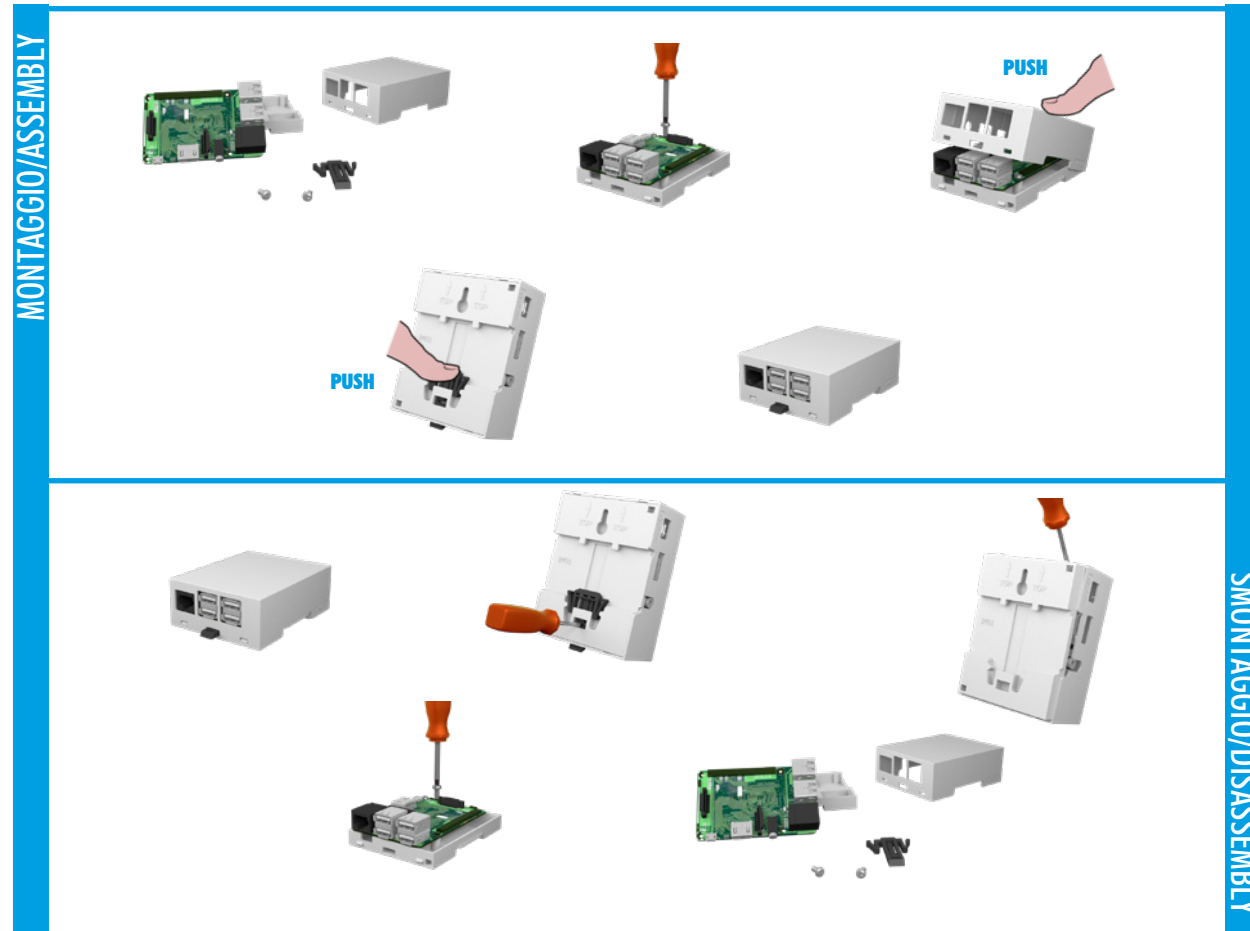

RASPBERY PI 3

CARATTERISTICHE GENERALI

Contenitore per RASPBERY PI 3 per guida DIN (EN 60715)

Materiale: PC/ABS autoestinguente UL94V-0
Colore: Grigio

CONTENITORE PER GUIDA DIN (EN 60715)

Italtronic propone una nuova linea di contenitori industriali e per HOME & BUILDING AUTOMATION adatti a contenere le più note schede elettroniche EMBEDDED.



RASPBERY PI 3

GENERAL FEATURES

RASPBERY PI 3 for rail DIN (EN 60715) application

Material: PC/ABS self-extinguishing UL94V-0
Colour: Grey

DIN RAIL (EN 60715) ENCLOSURE

Italtronic propose a new industrial and HOME & BUILDING AUTOMATION enclosures useful to contain the more famous EMBEDDED electronic boards.

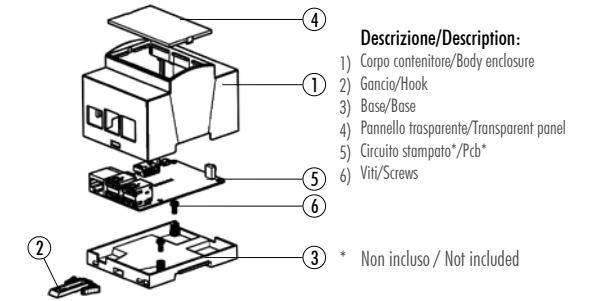

Contenitore Completo/Complete Enclosure

CODICE / CODE	COLORE / COLOUR	DESCRIZIONE/DESCRIPTION	FORMA/SHAPE
25.0410000.RP3	Grigio/Grey	Kit 4M XTS Raspberry PI 3 Modello B/4M XTS Raspberry PI 3 Model B kit	C/C

Composizione Kit: il Kit comprende corpo, base, gancio, pannello trasparente, 2 viti

Kit composition: kit includes body enclosure, base, hook, transparent panel, 2 screws

DIMENSIONI B/B DIMENSIONS: 90 mm
DIMENSIONI L/L DIMENSIONS: 71 mm
DIMENSIONI H/H DIMENSIONS: 55 mm

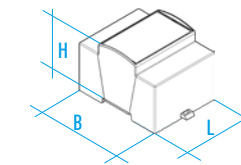

CONFEZIONE N° PCS/KIT: PACKAGING N° PCS/KIT:	50	PESO DELLA CONFEZIONE: PACKAGING WEIGHT:	4,5 kg	MINIMO ACQUISTABILE: MINIMUM ORDER:	1	PESO DEL PEZZO KIT: KIT WEIGHT:	70 g
---	----	---	--------	--	---	------------------------------------	------

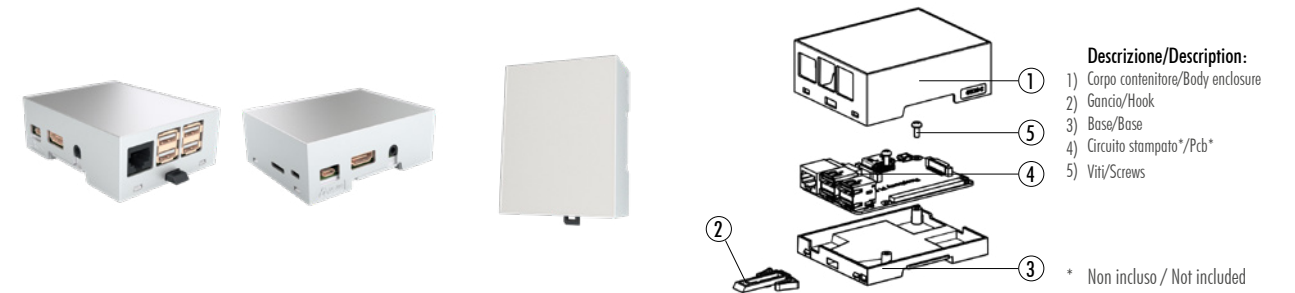

Contenitore Completo/Complete Enclosure

CODICE / CODE	COLORE / COLOUR	DESCRIZIONE/DESCRIPTION	FORMA/SHAPE
33.0414000.RP3	Grigio/Grey	Kit 4M XTS COMPACT Raspberry PI 3 Modello B/4M XTS COMPACT Raspberry PI 3 Model B kit/C	C/C

Composizione Kit: il Kit comprende corpo, base, gancio, 2 viti

Kit composition: kit includes body enclosure, base, hook, 2 screws

DIMENSIONI B/B DIMENSIONS: 90 mm
DIMENSIONI L/L DIMENSIONS: 71 mm
DIMENSIONI H/H DIMENSIONS: 32 mm

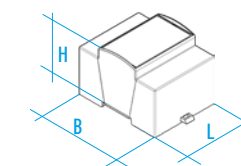

CONFEZIONE N° PCS/KIT: PACKAGING N° PCS/KIT:	100	PESO DELLA CONFEZIONE: PACKAGING WEIGHT:	6,0 kg	MINIMO ACQUISTABILE: MINIMUM ORDER:	1	PESO DEL PEZZO KIT: KIT WEIGHT:	50 g
---	-----	---	--------	--	---	------------------------------------	------

TIPO GUIDA DIN/DIN RAIL TYPE: Norme EN 60715/EN 60715 NORM
NORMA CONTENITORE/ENCLOSURE STANDARD: Norme DIN 43880/43880 DIN NORM





ASSEMBLAGGIO/DISASSEMBLAGGIO

RASPBERY PI 3

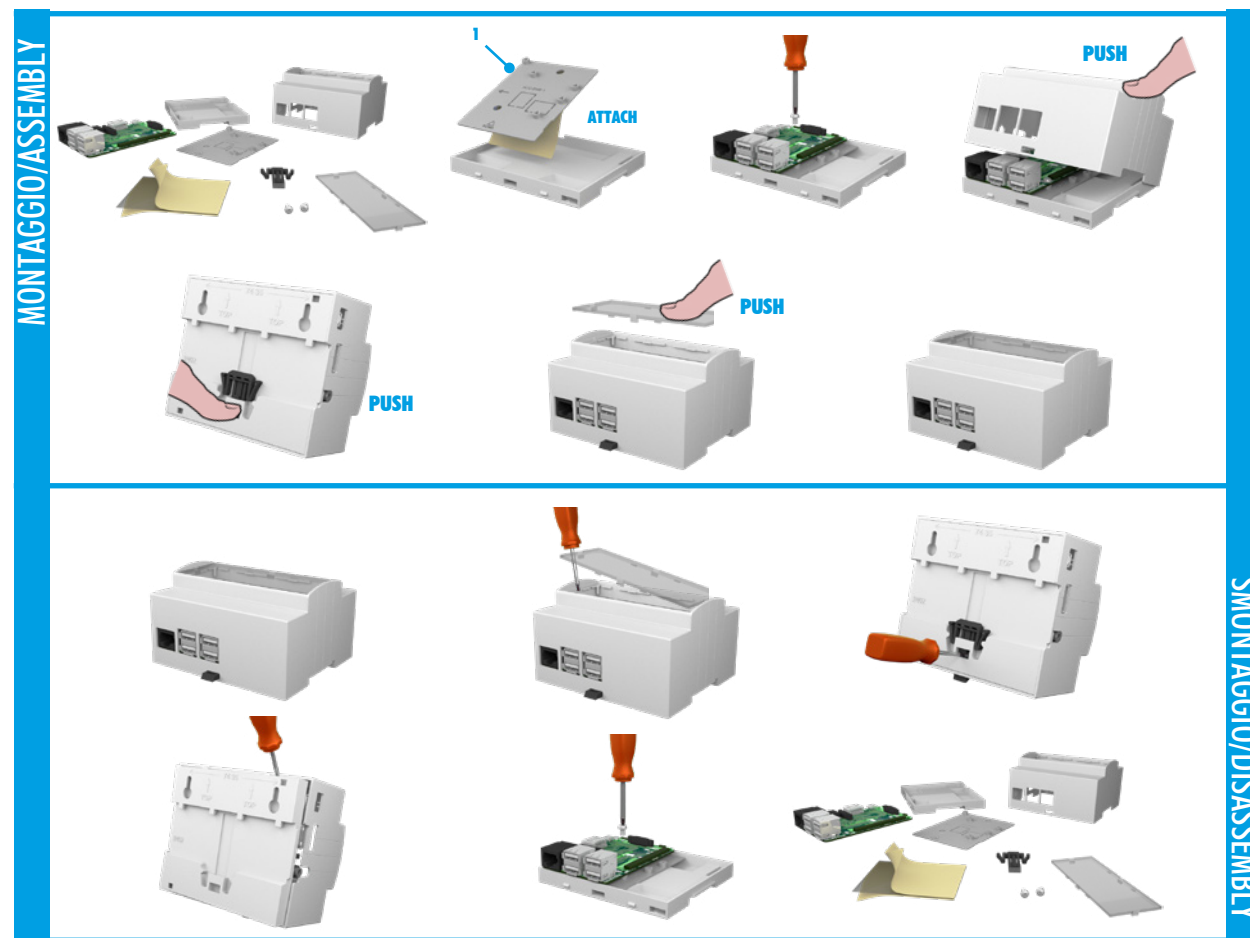

ASSEMBLY/DISASSEMBLY

RASPBERY PI 3

RASPBERY PI 3

CARATTERISTICHE GENERALI

Contenitore per RASPBERY PI 3 per guida DIN (EN 60715)

Materiale: PC/ABS autoestinguente UL94V-0
Colore: Grigio

CONTENITORE PER GUIDA DIN (EN 60715)

Italtronic propone una nuova linea di contenitori industriali e per HOME & BUILDING AUTOMATION adatti a contenere le più note schede elettroniche EMBEDDED.



RASPBERY PI 3

GENERAL FEATURES

RASPBERY PI 3 for rail DIN (EN 60715) application

Material: PC/ABS self-extinguishing UL94V-0
Colour: Grey

DIN RAIL (EN 60715) ENCLOSURE

Italtronic propose a new industrial and HOME & BUILDING AUTOMATION enclosures useful to contain the more famous EMBEDDED electronic boards.

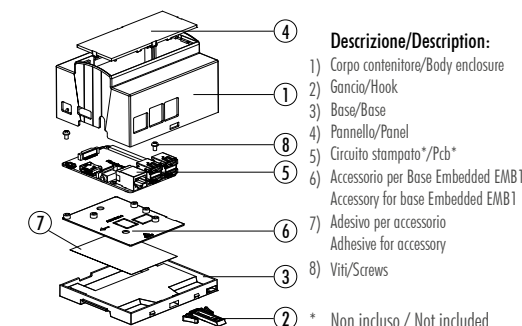

Contenitore Completo/Complete Enclosure

CODICE / CODE	COLORE / COLOUR	DESCRIZIONE/DESCRIPTION	FORMA/SHAPE
25.0610000.RP3	Grigio/Grey	Kit 6M XTS Raspberry PI 3 Modello B /6M XTS Raspberry PI 3 Model B kit	C/C

Composizione Kit: il Kit comprende corpo, base, gancio, pannello trasp., accessorio base embedded, adesivo, 3 viti.

Kit composition: kit includes body enclosure, base, hook, transparent panel, accessory for base embedded, adhesive for accessory, 3 screws.

DIMENSIONI B/B DIMENSIONS: 90 mm
DIMENSIONI L/L DIMENSIONS: 106,5 mm
DIMENSIONI H/H DIMENSIONS: 55 mm

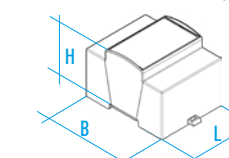

CONFEZIONE N° PCS/KIT: 25	PESO DELLA CONFEZIONE: 3,25 kg	MINIMO ACQUISTABILE: 1	PESO DEL PEZZO KIT: 90 g
PACKAGING N° PCS/KIT:	PACKAGING WEIGHT:	MINIMUM ORDER:	KIT WEIGHT:

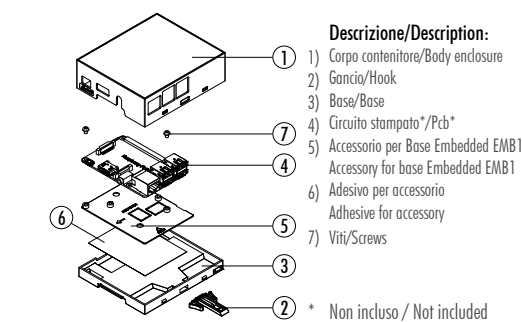

Contenitore Completo/Complete Enclosure

CODICE / CODE	COLORE / COLOUR	DESCRIZIONE/DESCRIPTION	FORMA/SHAPE
33.0614000.RP3	Grigio/Grey	Kit 6M XTS COMPACT Raspberry PI 3 Modello B /6M XTS COMPACT Raspberry PI 3 Model B kit	C/C

Composizione Kit: il Kit comprende corpo, base, gancio, accessorio base embedded, adesivo, 3 viti.

Kit composition: kit includes body enclosure, base, hook, accessory for base embedded, adhesive for accessory, 3 screws.

DIMENSIONI B/B DIMENSIONS: 90 mm
DIMENSIONI L/L DIMENSIONS: 106,5 mm
DIMENSIONI H/H DIMENSIONS: 32 mm

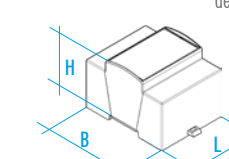

CONFEZIONE N° PCS/KIT: 50	PESO DELLA CONFEZIONE: 4,75 kg	MINIMO ACQUISTABILE: 1	PESO DEL PEZZO KIT: 75 g
PACKAGING N° PCS/KIT:	PACKAGING WEIGHT:	MINIMUM ORDER:	KIT WEIGHT:

RASPBERY PI 3 compact

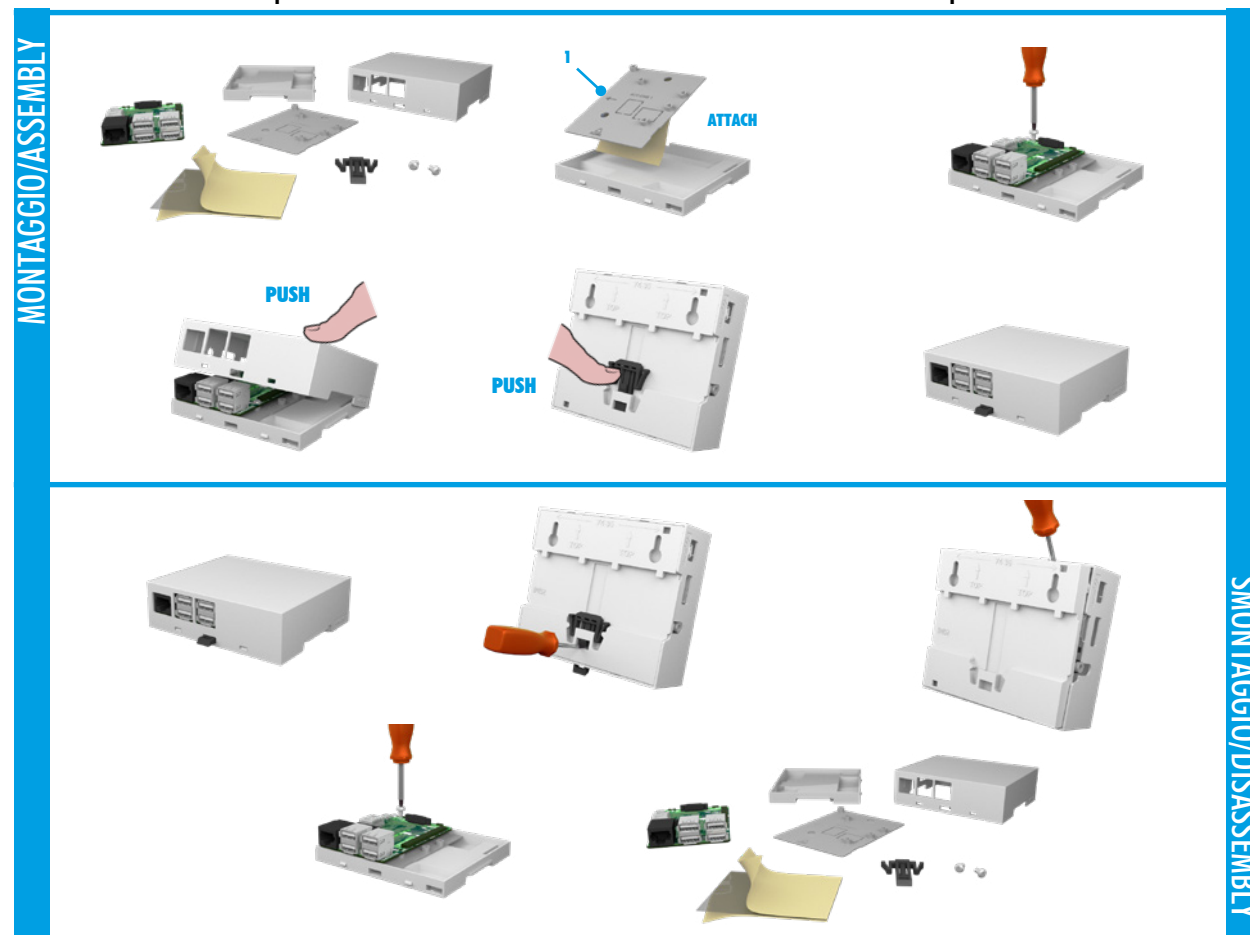

RASPBERY PI 3 compact

TIPO GUIDA DIN/DIN RAIL TYPE: Norme EN 60715/EN 60715 NORM

NORMA CONTENITORE/ENCLOSURE STANDARD: Norme DIN 43880/43880 DIN NORM



RASPERRY PI COMPUTE MODULE compact

RASPERRY PI COMPUTE MODULE compact

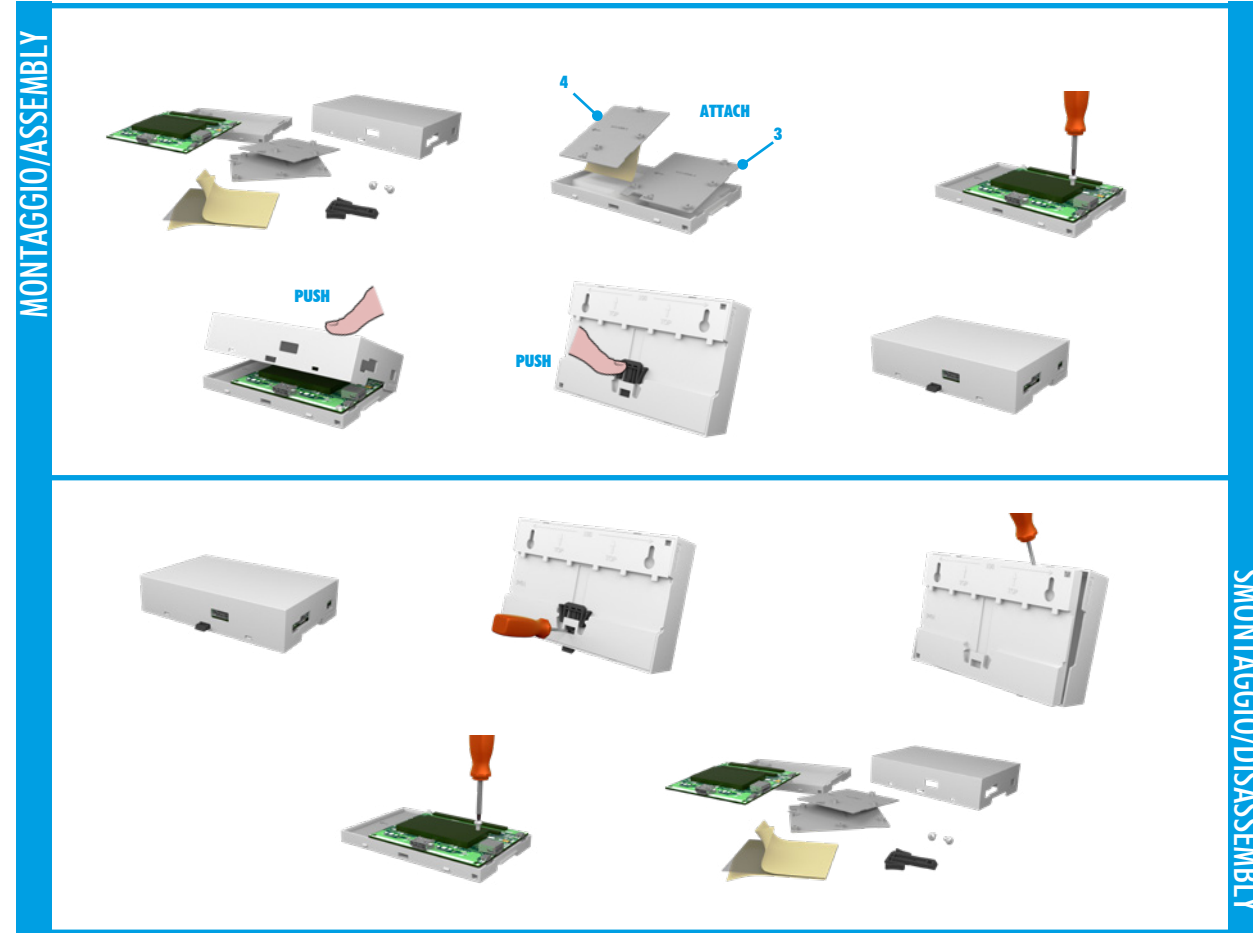

EMBEDDED BOX

MONTAGGIO/ASSEMBLY

SMONTAGGIO/DISASSEMBLY



RaspberryPi

RASPERRY PI COMPUTE MODULE for rail din (EN 60715) application.

Material: PC/ABS self-extinguishing UL94V-0
Colour: Grey

Contenitore per RASPERRY PI COMPUTE MODULE per guida DIN (EN 60715)

Material: PC/ABS autoestinguente UL94V-0
Colore: Grigio

CONTENITORE PER GUIDA DIN (EN 60715)

Italtronic propone una nuova linea di contenitori industriali e per HOME & BUILDING AUTOMATION adatti a contenere le più note schede elettroniche EMBEDDED.

DIN RAIL (EN 60715) ENCLOSURE

Italtronic propose a new industrial and HOME & BUILDING AUTOMATION enclosures useful to contain the more famous EMBEDDED electronic boards.



Descrizione/Description:

- 1) Corpo contenitore/Body enclosure
- 2) Gancio/Hook
- 3) Base/Base
- 4) Circuito stampato/Pcb*
- 5) Accessorio per Base Embedded EMB1
- 6) Adesivo per accessorio
- 7) Viti/Screws

* Non incluso / Not included

Contenitore Completo/Complete Enclosure

CODICE / CODE	COLORE / COLOUR	DESCRIZIONE/DESCRIPTION	FORMA/SHAPE
35.0814000.RCM	Grigio/Grey	Kit 8M XTS COMPACT Raspberry Pi Compute Module/8M XTS COMPACT kit Raspberry Pi Compute Module	C/C

Composizione Kit: il Kit comprende corpo, base, gancio, 2 accessori base embedded, 2 adesivi, 2 viti.

Kit composition: kit includes body enclosure, base, hook, 2 accessories for base embedded, 2 adhesives for accessories, 2 screws.

DIMENSIONI B/B DIMENSIONS: 90 mm
DIMENSIONI L/L DIMENSIONS: 142,5 mm
DIMENSIONI H/H DIMENSIONS: 32 mm

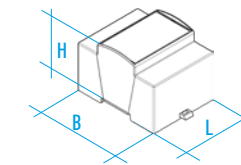

CONFEZIONE N° PCS/KIT: PACKAGING N° PCS/KIT:	50	PESO DELLA CONFEZIONE: PACKAGING WEIGHT:	5,5 kg	MINIMO ACQUISTABILE: MINIMUM ORDER:	1	PESO DEL PEZZO KIT: KIT WEIGHT:	90 g
---	----	---	--------	--	---	------------------------------------	------

TIPO GUIDA DIN/DIN RAIL TYPE: Norme EN 60715/EN 60715 NORM
NORMA CONTENITORE/ENCLOSURE STANDARD: Norme DIN 43880/43880 DIN NORM



EMBEDDED BOX



RaspberryPi



ASSEMBLAGGIO/DISASSEMBLAGGIO

ASSEMBLY/DISASSEMBLY

RASPBERY ZERO

RASPBERY ZERO

MONTAGGIO/ASSEMBLY

SMONTAGGIO/DISASSEMBLY

RASPBERY ZERO compact

RASPBERY ZERO compact

MONTAGGIO/ASSEMBLY

SMONTAGGIO/DISASSEMBLY

RASPBERY ZERO

CARATTERISTICHE GENERALI

Contenitore per RASPBERY ZERO per applicazione industriale su guida DIN (EN 60715)

Materiale: PC/ABS autoestinguente UL94V-0
Colore: Grigio

CONTENITORE PER GUIDA DIN (EN 60715)

Italtronic propone una nuova linea di contenitori industriali e per HOME & BUILDING AUTOMATION adatti a contenere le più note schede elettroniche EMBEDDED.

RASPBERY ZERO

GENERAL FEATURES

RASPBERY ZERO enclosure for rail din industrial (EN 60715) application.

Material: PC/ABS self-extinguishing UL94V-0
Colour: Grey

DIN RAIL (EN 60715) ENCLOSURE

Italtronic propose a new industrial and HOME & BUILDING AUTOMATION enclosures useful to contain the more famous EMBEDDED electronic boards.

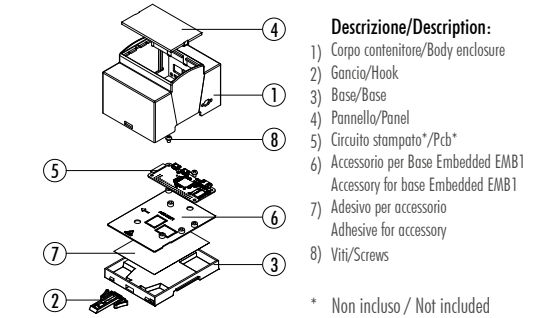

Contenitore Completo/Complete Enclosure

CODICE / CODE	COLORE / COLOUR	DESCRIZIONE/DESCRIPTION	FORMA/SHAPE
25.0410000.RPZ	Grigio/Grey	Kit 4M XTS Raspberry ZERO /4M XTS Raspberry ZERO kit	C/C

Composizione Kit: il Kit comprende corpo, base, gancio, pannello trasparente, accessorio base embedded, adesivo, 2 viti.

Kit composition: kit includes body enclosure, base, hook, transparent panel, accessory base embedded, adhesive, 2 screws.

DIMENSIONI B/B DIMENSIONS: 90 mm
DIMENSIONI L/L DIMENSIONS: 74 mm
DIMENSIONI H/H DIMENSIONS: 55 mm

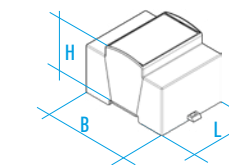

CONFEZIONE N° PCS/KIT: PACKAGING N° PCS/KIT:	50	PESO DELLA CONFEZIONE: PACKAGING WEIGHT:	4,5 kg	MINIMO ACQUISTABILE: MINIMUM ORDER:	1	PESO DEL PEZZO KIT: KIT WEIGHT:	70 g
---	----	---	--------	--	---	------------------------------------	------

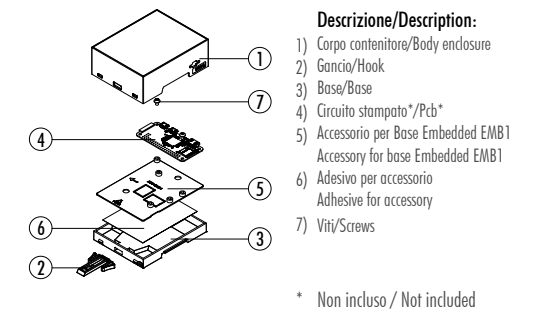

Contenitore Completo/Complete Enclosure

CODICE / CODE	COLORE / COLOUR	DESCRIZIONE/DESCRIPTION	FORMA/SHAPE
33.0414000.RPZ	Grigio/Grey	Kit 4M XTS COMPACT Raspberry ZERO /4M XTS COMPACT Raspberry ZERO kit	C/C

Composizione Kit: il Kit comprende corpo, base, gancio, accessorio base embedded, adesivo, 2 viti.

Kit composition: kit includes body enclosure, base, hook, accessory base embedded, adhesive, 2 screws.

DIMENSIONI B/B DIMENSIONS: 90 mm
DIMENSIONI L/L DIMENSIONS: 74 mm
DIMENSIONI H/H DIMENSIONS: 32 mm

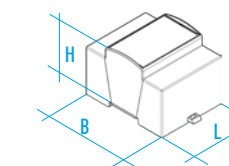

CONFEZIONE N° PCS/KIT: PACKAGING N° PCS/KIT:	100	PESO DELLA CONFEZIONE: PACKAGING WEIGHT:	6,0 kg	MINIMO ACQUISTABILE: MINIMUM ORDER:	1	PESO DEL PEZZO KIT: KIT WEIGHT:	50 g
---	-----	---	--------	--	---	------------------------------------	------

TIPO GUIDA DIN/DIN RAIL TYPE: Norme EN 60715/EN 60715 NORM
NORMA CONTENITORE/ENCLOSURE STANDARD: Norme DIN 43880/43880 DIN NORM





ASSEMBLAGGIO/DISASSEMBLAGGIO

ASSEMBLY/DISASSEMBLY

RASPBERRY PI 4

RASPBERRY PI 4

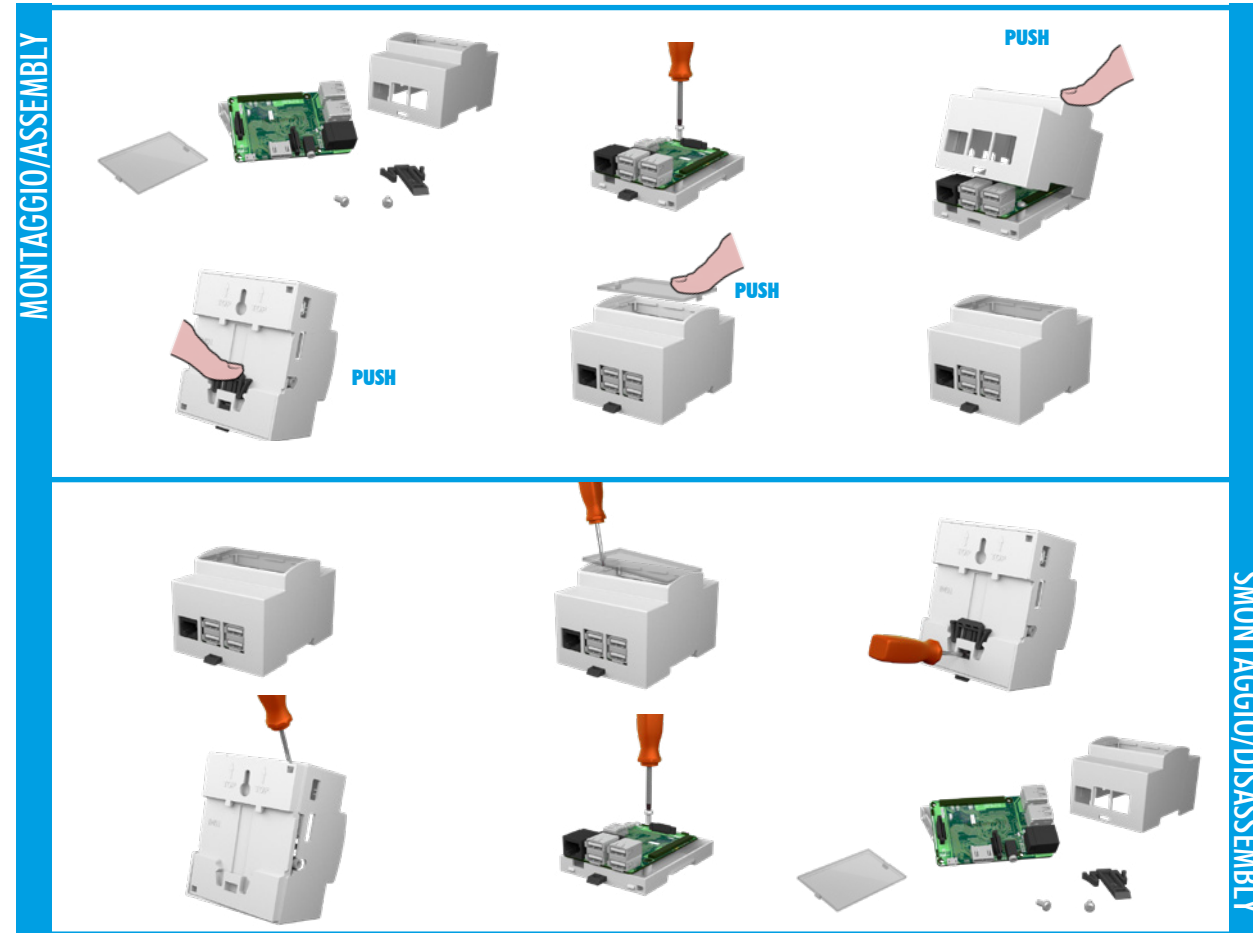

RASPBERRY PI 4 compact

RASPBERRY PI 4 compact

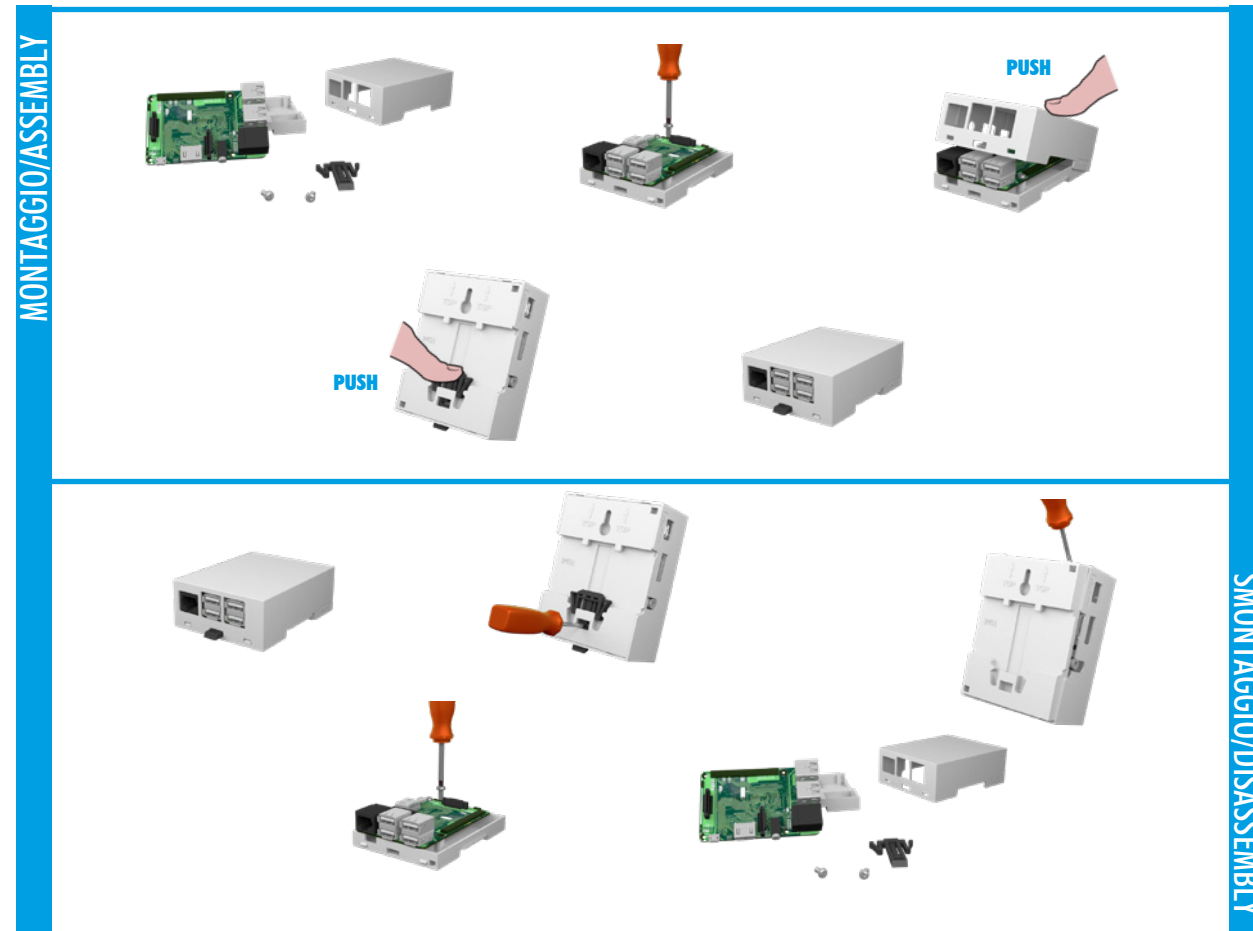

RASPBERRY PI 4

CARATTERISTICHE GENERALI

Contenitore per RASPBERRY PI 4 per guida DIN (EN 60715)

Materiale: PC/ABS autoestinguente
Colore: Grigio

CONTENITORE PER GUIDA DIN (EN 60715)

Italtronic propone una nuova linea di contenitori industriali e per HOME & BUILDING AUTOMATION adatti a contenere le più note schede elettroniche EMBEDDED



RASPBERRY PI 4

GENERAL FEATURES

RASPBERRY PI 4 for rail DIN (EN 60715) application

Material: PC/ABS self-extinguishing
Colour: Grey

DIN RAIL (EN 60715) ENCLOSURE

Italtronic propose a new industrial and HOME & BUILDING AUTOMATION enclosures useful to contain the more famous EMBEDDED electronic boards.

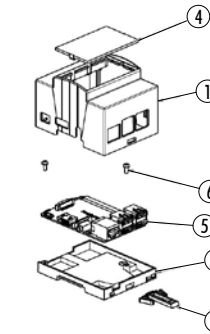

- Descrizione/Description:
- 1) Corpo contenitore/Body enclosure
 - 2) Gancio/Hook
 - 3) Base/Base
 - 4) Pannello trasparente/Transparent panel
 - 5) Circuito stampato*/Pcb*
 - 6) Viti/Screws

* Non incluso / Not included

Contenitore Completo/Complete Enclosure

CODICE / CODE	COLORE / COLOUR	DESCRIZIONE/DESCRIPTION	FORMA/SHAPE
25.041000.RP4	Grigio/Grey	Kit 4M XTS Raspberry PI 4 Modello B/4M XTS Raspberry PI 4 Model B kit	C/C

Composizione Kit: il Kit comprende corpo, base, gancio, pannello trasp., 2 viti

Kit composition: kit includes body enclosure, base, hook, transparent panel, 2 screws

DIMENSIONI B/B DIMENSIONS: 90 mm
DIMENSIONI L/L DIMENSIONS: 71 mm
DIMENSIONI H/H DIMENSIONS: 55 mm

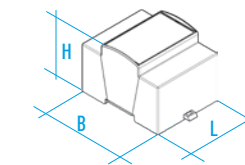

CONFEZIONE N° PCS/KIT: PACKAGING N° PCS/KIT:	50	PESO DELLA CONFEZIONE: PACKAGING WEIGHT:	3,7 kg	MINIMO ACQUISTABILE: MINIMUM ORDER:	1	PESO DEL PEZZO KIT: KIT WEIGHT:	70 g
---	----	---	--------	--	---	------------------------------------	------

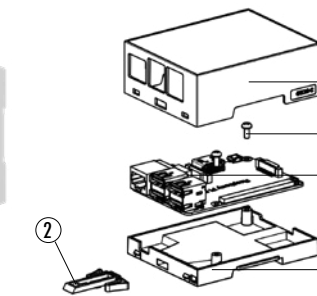

- Descrizione/Description:
- 1) Corpo contenitore/Body enclosure
 - 2) Gancio/Hook
 - 3) Base/Base
 - 4) Circuito stampato*/Pcb*
 - 5) Viti/Screws

* Non incluso / Not included

Contenitore Completo/Complete Enclosure

CODICE / CODE	COLORE / COLOUR	DESCRIZIONE/DESCRIPTION	FORMA/SHAPE
33.0414000.RP4	Grigio/Grey	Kit 4M XTS Compact Raspberry PI 4 Modello B/4M XTS Compact Raspberry PI 4 Model B kit	C/C

Composizione Kit: il Kit comprende corpo, base, gancio, 2 viti

Kit composition: kit includes body enclosure, base, hook, 2 screws

DIMENSIONI B/B DIMENSIONS: 90 mm
DIMENSIONI L/L DIMENSIONS: 71 mm
DIMENSIONI H/H DIMENSIONS: 32 mm

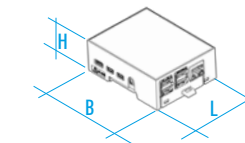

CONFEZIONE N° PCS/KIT: PACKAGING N° PCS/KIT:	100	PESO DELLA CONFEZIONE: PACKAGING WEIGHT:	5,2 kg	MINIMO ACQUISTABILE: MINIMUM ORDER:	1	PESO DEL PEZZO KIT: KIT WEIGHT:	50 g
---	-----	---	--------	--	---	------------------------------------	------

TIPO GUIDA DIN/DIN RAIL TYPE: Norme EN 60715/EN 60715 NORM
NORMA CONTENITORE/ENCLOSURE STANDARD: Norme DIN 43880/43880 DIN NORM



RASPBERY PI 4

RASPBERY PI 4

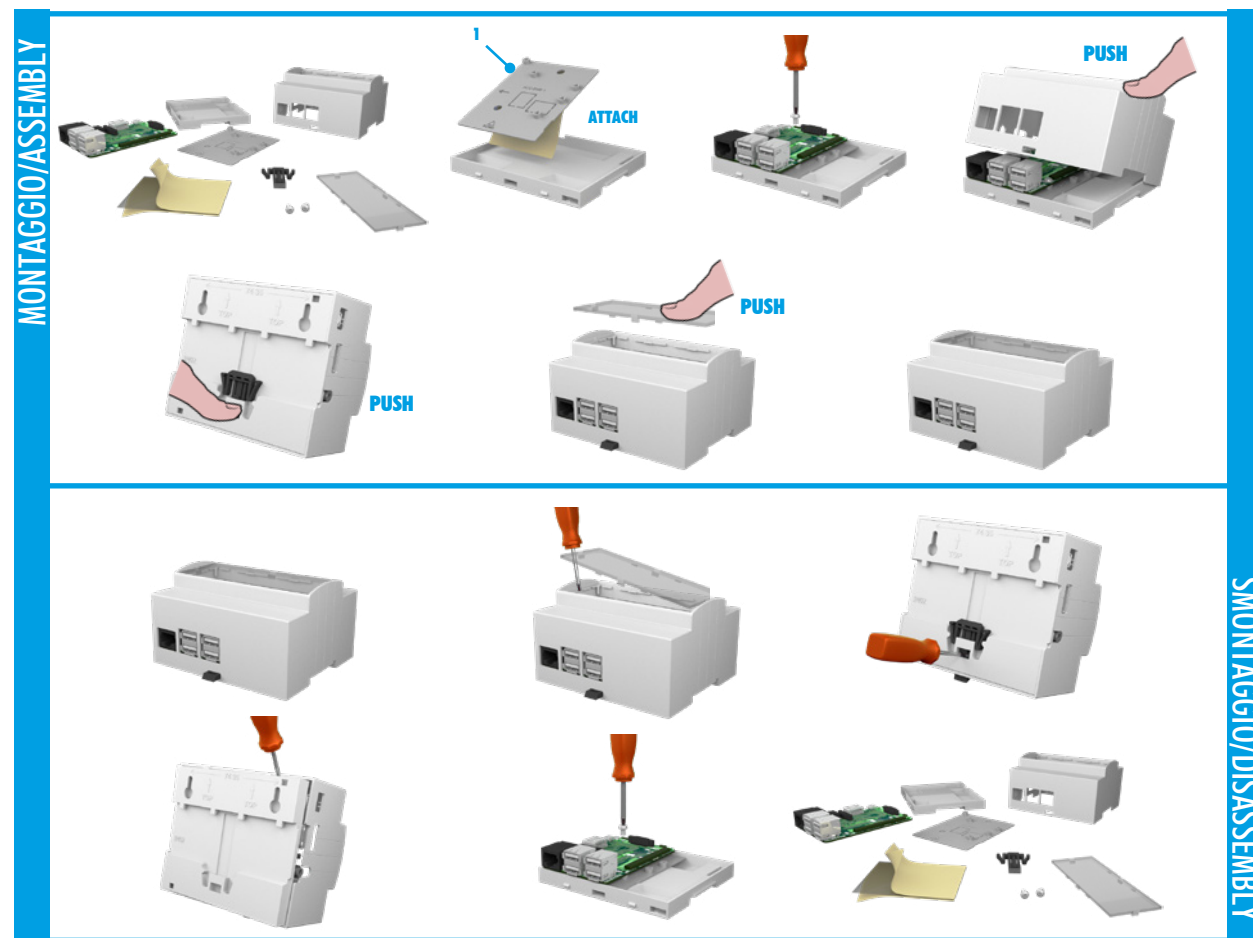

RASPBERY PI 4 compact

RASPBERY PI 4 compact

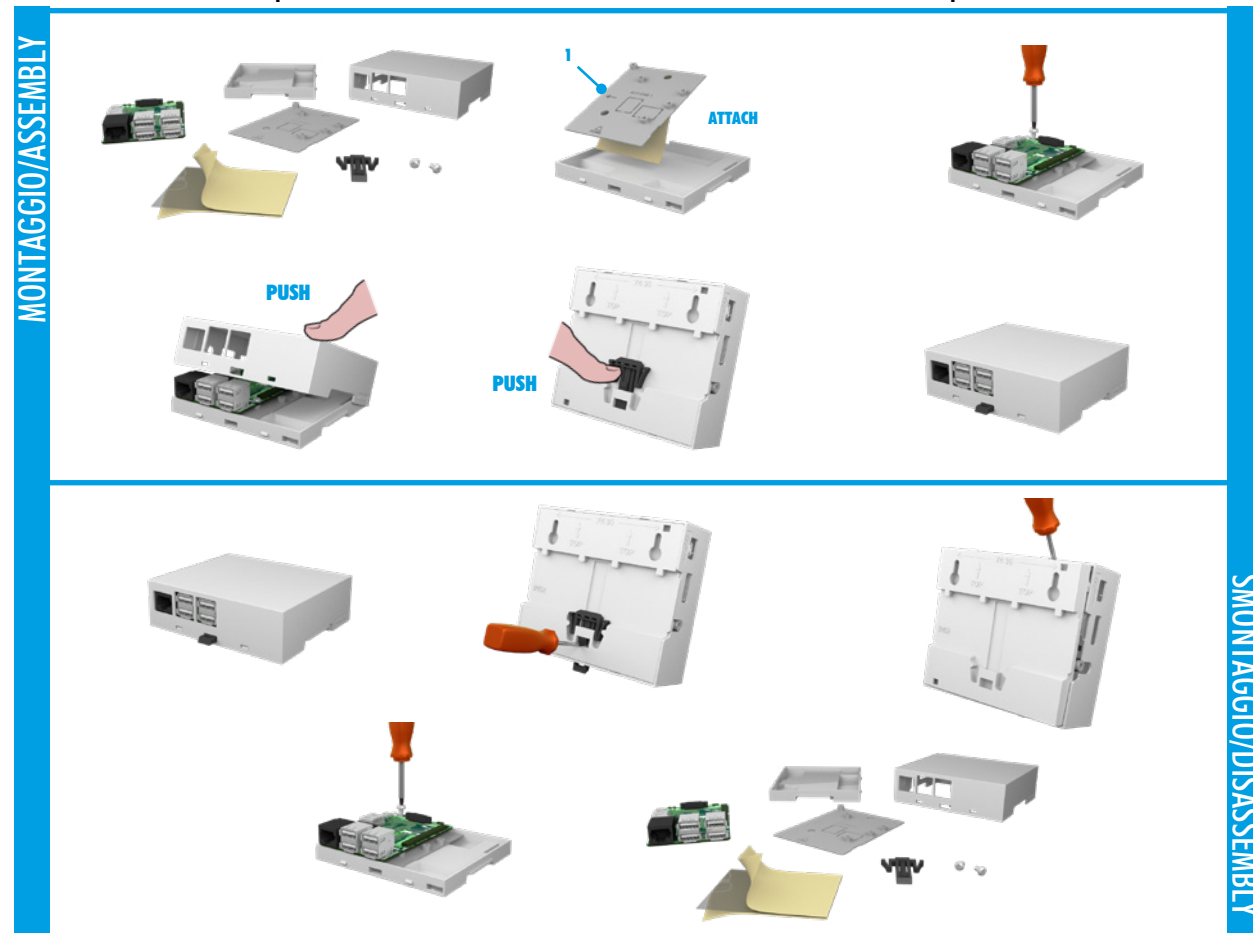

EMBEDDED BOX



RASPBERY PI 4

CARATTERISTICHE GENERALI

Contenitore per RASPBERY PI 4 per guida DIN (EN 60715)

Materiale: PC/ABS autoestinguente
Colore: Grigio

CONTENITORE PER GUIDA DIN (EN 60715)

Italtronic propone una nuova linea di contenitori industriali e per HOME & BUILDING AUTOMATION adatti a contenere le più note schede elettroniche EMBEDDED.



Contenitore Completo/Complete Enclosure

CODICE / CODE	COLORE / COLOUR	DESCRIZIONE/DESCRIPTION	FORMA/SHAPE
25.0610000.RP4	Grigio/Grey	Kit 6M XTS Raspberry Pi 4 Modello B / 6M XTS Raspberry Pi 4 Model B kit	C/C

Composizione Kit: il Kit comprende corpo, base, gancio, pannello trasp., 2 viti.

Kit composition: kit includes body enclosure, base, hook, transparent panel, 2screws.

DIMENSIONI B/B DIMENSIONS: 90 mm
DIMENSIONI L/L DIMENSIONS: 106,5 mm
DIMENSIONI H/H DIMENSIONS: 55 mm

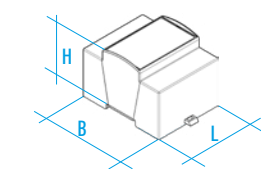

RASPBERY PI 4

GENERAL FEATURES

RASPBERY PI 4 for rail DIN (EN 60715) application

Material: PC/ABS self-extinguishing
Colour: Grey

DIN RAIL (EN 60715) ENCLOSURE

Italtronic propose a new industrial and HOME & BUILDING AUTOMATION enclosures useful to contain the more famous EMBEDDED electronic boards.

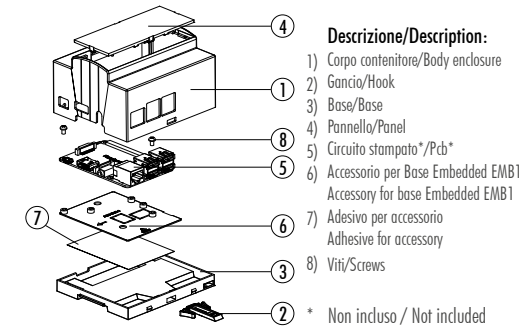

CONFEZIONE N° PCS/KIT: 25	PESO DELLA CONFEZIONE: 2,4 kg	MINIMO ACQUISTABILE: 1	PESO DEL PEZZO KIT: 90 g
PACKAGING N° PCS/KIT:	PACKAGING WEIGHT:	MINIMUM ORDER:	KIT WEIGHT:



Contenitore Completo/Complete Enclosure

CODICE / CODE	COLORE / COLOUR	DESCRIZIONE/DESCRIPTION	FORMA/SHAPE
33.0614000.RP4	Grigio/Grey	Kit 6M XTS COMPACT Raspberry Pi 4 Modello B / 6M XTS COMPACT Raspberry Pi 4 Model B kit	C/C

Composizione Kit: il Kit comprende corpo, base, gancio, 2 viti.

Kit composition: kit includes body enclosure, base, hook, 2 screws.

DIMENSIONI B/B DIMENSIONS: 90 mm
DIMENSIONI L/L DIMENSIONS: 106,5 mm
DIMENSIONI H/H DIMENSIONS: 32 mm

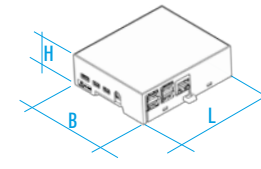

CONFEZIONE N° PCS/KIT: 50	PESO DELLA CONFEZIONE: 4,75 kg	MINIMO ACQUISTABILE: 1	PESO DEL PEZZO KIT: 75 g
PACKAGING N° PCS/KIT:	PACKAGING WEIGHT:	MINIMUM ORDER:	KIT WEIGHT:

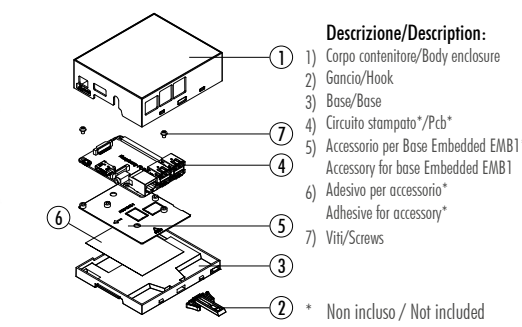

TIPO GUIDA DIN/DIN RAIL TYPE: Norme EN 60715/EN 60715 NORM
NORMA CONTENITORE/ENCLOSURE STANDARD: Norme DIN 43880/43880 DIN NORM

EMBEDDED BOX



ASSEMBLAGGIO/DISASSEMBLAGGIO

ASSEMBLY/DISASSEMBLY

RAILBOX RASPBERRY PI

RAILBOX RASPBERRY PI

MONTAGGIO/ASSEMBLY

SMONTAGGIO/DISASSEMBLY



RAILBOX RASPBERRY PI B+ / PI 3 / P4

RAILBOX RASPBERRY PI B+ / PI 3 / P4

MONTAGGIO/ASSEMBLY

SMONTAGGIO/DISASSEMBLY



RASPBERRY PI

CARATTERISTICHE GENERALI

Contenitore per RASPBERRY PI per applicazione industriale su guida DIN (EN 60715)

Materiale: PC/ABS autoestinguente UL94V-0
Colore: Grigio

CONTENITORE PER GUIDA DIN (EN 60715)

Italtronic propone una nuova linea di contenitori industriali e per HOME & BUILDING AUTOMATION adatti a contenere le più note schede elettroniche EMBEDDED.



Contenitore Completo/Complete Enclosure

CODICE / CODE	COLORE / COLOUR	DESCRIZIONE/DESCRIPTION	FORMA/SHAPE
T0.0012225.RPI	Grigio/Grey	Kit 22,5 Raspberry PI Railbox/22,5 Railbox Raspberry PI kit	

Composizione Kit: il Kit comprende base, coperchio, gancio, molla, accessori laterali, pannello frontale

Kit composition: kit includes base, cover, hook, spring, lateral accessories, front panel.

DIMENSIONI B/B DIMENSIONS: 22,5 mm
DIMENSIONI L/L DIMENSIONS: 101 mm
DIMENSIONI H/H DIMENSIONS: 119,5 mm

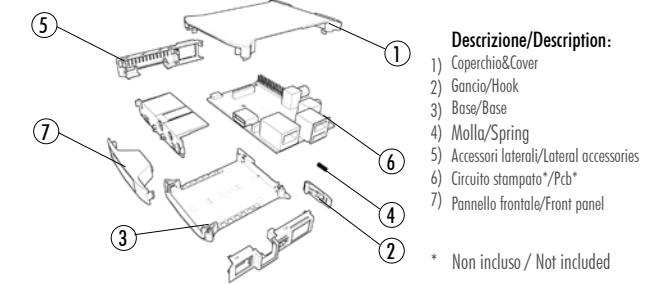
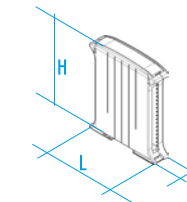

CONFEZIONE N° PCS/KIT: PACKAGING N° PCS/KIT: 50	PESO DELLA CONFEZIONE: PACKAGING WEIGHT: 4,75 kg	MINIMO ACQUISTABILE: MINIMUM ORDER: 1	PESO DEL PEZZO KIT: KIT WEIGHT: 75 g
--	---	--	---

Contenitore Completo/Complete Enclosure

CODICE / CODE	COLORE / COLOUR	DESCRIZIONE/DESCRIPTION	FORMA/SHAPE
T0.0052450.RPI	Grigio/Grey	Kit 45 Raspberry PI Railbox/45 Railbox Raspberry PI kit	

Composizione Kit: il Kit comprende base, coperchio, gancio, molla, accessori laterali, pannello frontale

Kit composition: kit includes base, cover, hook, spring, lateral accessories, front panel.

DIMENSIONI B/B DIMENSIONS: 45 mm
DIMENSIONI L/L DIMENSIONS: 101 mm
DIMENSIONI H/H DIMENSIONS: 119,5 mm

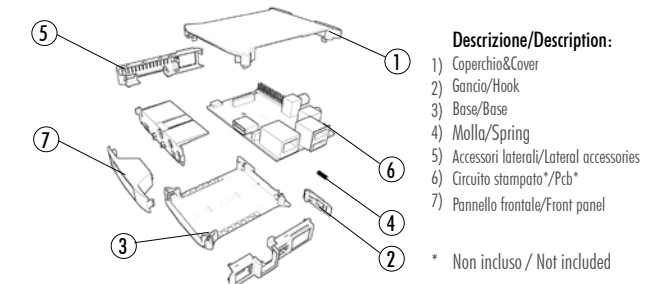
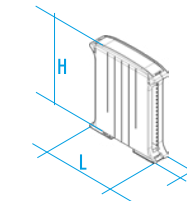

CONFEZIONE N° PCS/KIT: PACKAGING N° PCS/KIT: 50	PESO DELLA CONFEZIONE: PACKAGING WEIGHT: 6,0 kg	MINIMO ACQUISTABILE: MINIMUM ORDER: 1	PESO DEL PEZZO KIT: KIT WEIGHT: 100 g
--	--	--	--

TIPO GUIDA DIN/DIN RAIL TYPE: Norme EN 60715/EN 60715 NORM



RASPBERRY PI B+

CARATTERISTICHE GENERALI

Contenitore per RASPBERRY PI B+ per applicazione industriale su guida DIN (EN 60715)

Materiale: PC/ABS autoestinguento UL94V-0
Colore: Grigio

CONTENITORE PER GUIDA DIN (EN 60715)

Italtronic propone una nuova linea di contenitori industriali e per HOME & BUILDING AUTOMATION adatti a contenere le più note schede elettroniche EMBEDDED.



RASPBERRY PI B+

GENERAL FEATURES

RASPBERRY PI B+ enclosure for rail din industrial (EN 60715) application.

Material: PC/ABS self-extinguishing UL94V-0
Colour: Grey

DIN RAIL (EN 60715) ENCLOSURE

Italtronic propose a new industrial and HOME & BUILDING AUTOMATION enclosures useful to contain the more famous EMBEDDED electronic boards.

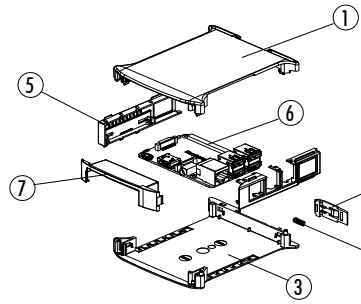

Descrizione/Description:

- 1) Coperchio/Cover
- 2) Gancio/Hook
- 3) Base/Base
- 4) Molla/Spring
- 5) Accessori laterali/Lateral accessories
- 6) Circuito stampato*/Pcb*
- 7) Pannello frontale/Front panel

* Non incluso / Not included

Contenitore Completo/Complete Enclosure

CODICE / CODE	COLORE / COLOUR	DESCRIZIONE/DESCRIPTION	FORMA/SHAPE
10.0012225.RMB	Grigio/Grey	Kit 22,5 Raspberry PI B+ Railbox/22,5 Railbox Raspberry PI B+ kit	

Composizione Kit: il Kit comprende base, coperchio, gancio, molla, accessori laterali, pannello frontale

Kit composition: kit includes base, cover, hook, spring, lateral accessories, front panel.

DIMENSIONI B/B DIMENSIONS: 22,5 mm
DIMENSIONI L/L DIMENSIONS: 101 mm
DIMENSIONI H/H DIMENSIONS: 119,5 mm

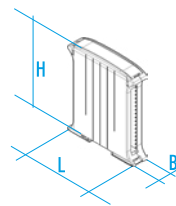

CONFEZIONE N° PCS/KIT: PACKAGING N° PCS/KIT: 50	PESO DELLA CONFEZIONE: PACKAGING WEIGHT: 4,5 kg	MINIMO ACQUISTABILE: MINIMUM ORDER: 1	PESO DEL PEZZO KIT: KIT WEIGHT: 70 g
--	--	--	---

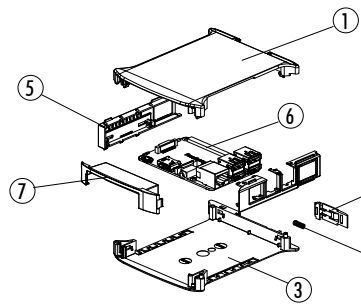

Descrizione/Description:

- 1) Coperchio/Cover
- 2) Gancio/Hook
- 3) Base/Base
- 4) Molla/Spring
- 5) Accessori laterali/Lateral accessories
- 6) Circuito stampato*/Pcb*
- 7) Pannello frontale/Front panel

* Non incluso / Not included

Contenitore Completo/Complete Enclosure

CODICE / CODE	COLORE / COLOUR	DESCRIZIONE/DESCRIPTION	FORMA/SHAPE
10.0052450.RMB	Grigio/Grey	Kit 45 Raspberry PI B+ Railbox/45 Railbox Raspberry PI B+ kit	

Composizione Kit: il Kit comprende base, coperchio, gancio, molla, accessori laterali, pannello frontale

Kit composition: kit includes base, cover, hook, spring, lateral accessories, front panel.

DIMENSIONI B/B DIMENSIONS: 45 mm
DIMENSIONI L/L DIMENSIONS: 101 mm
DIMENSIONI H/H DIMENSIONS: 119,5 mm

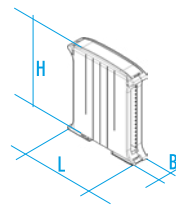

CONFEZIONE N° PCS/KIT: PACKAGING N° PCS/KIT: 50	PESO DELLA CONFEZIONE: PACKAGING WEIGHT: 5,75 kg	MINIMO ACQUISTABILE: MINIMUM ORDER: 1	PESO DEL PEZZO KIT: KIT WEIGHT: 95 g
--	---	--	---



TIPO GUIDA DIN/DIN RAIL TYPE: Norme EN 60715/EN 60715 NORM

RASPBERRY PI 3

GENERAL FEATURES

RASPBERRY PI 3 enclosure for rail din industrial (EN 60715) application.

Material: PC/ABS self-extinguishing UL94V-0
Colour: Grey

DIN RAIL (EN 60715) ENCLOSURE

Italtronic propose a new industrial and HOME & BUILDING AUTOMATION enclosures useful to contain the more famous EMBEDDED electronic boards.

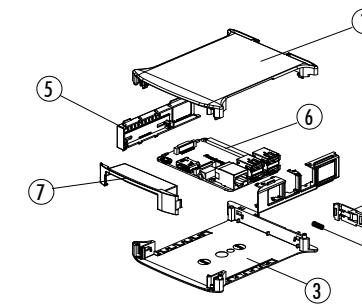

Descrizione/Description:

- 1) Coperchio/Cover
- 2) Gancio/Hook
- 3) Base/Base
- 4) Molla/Spring
- 5) Accessori laterali/Lateral accessories
- 6) Circuito stampato*/Pcb*
- 7) Pannello frontale/Front panel

* Non incluso / Not included

Contenitore Completo/Complete Enclosure

CODICE / CODE	COLORE / COLOUR	DESCRIZIONE/DESCRIPTION	FORMA/SHAPE
10.0012225.RP3	Grigio/Grey	Kit 22,5 Railbox Raspberry PI 3/22,5 Railbox Raspberry PI 3 kit	

Composizione Kit: il Kit comprende base, coperchio, gancio, molla, accessori laterali, pannello frontale.

Kit composition: kit includes base, cover, hook, spring, lateral accessories, front panel.

DIMENSIONI B/B DIMENSIONS: 22,5 mm
DIMENSIONI L/L DIMENSIONS: 101 mm
DIMENSIONI H/H DIMENSIONS: 119,5 mm

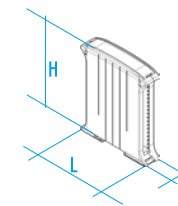

CONFEZIONE N° PCS/KIT: PACKAGING N° PCS/KIT: 50	PESO DELLA CONFEZIONE: PACKAGING WEIGHT: 4,75 kg	MINIMO ACQUISTABILE: MINIMUM ORDER: 1	PESO DEL PEZZO KIT: KIT WEIGHT: 75 g
--	---	--	---

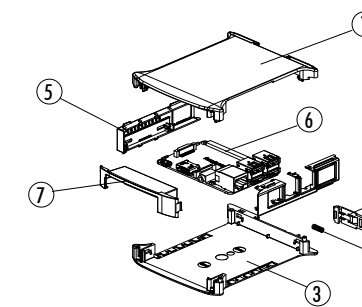

Descrizione/Description:

- 1) Coperchio/Cover
- 2) Gancio/Hook
- 3) Base/Base
- 4) Molla/Spring
- 5) Accessori laterali/Lateral accessories
- 6) Circuito stampato*/Pcb*
- 7) Pannello frontale/Front panel

* Non incluso / Not included

Contenitore Completo/Complete Enclosure

CODICE / CODE	COLORE / COLOUR	DESCRIZIONE/DESCRIPTION	FORMA/SHAPE
10.0052450.RP3	Grigio/Grey	Kit 45 Railbox Raspberry PI 3/45 Railbox Raspberry PI 3 kit	

Composizione Kit: il Kit comprende base, coperchio, gancio, molla, accessori laterali, pannello frontale.

Kit composition: kit includes base, cover, hook, spring, lateral accessories, front panel.

DIMENSIONI B/B DIMENSIONS: 45 mm
DIMENSIONI L/L DIMENSIONS: 101 mm
DIMENSIONI H/H DIMENSIONS: 119,5 mm

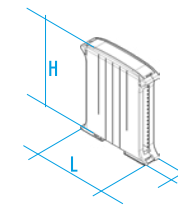

CONFEZIONE N° PCS/KIT: PACKAGING N° PCS/KIT: 50	PESO DELLA CONFEZIONE: PACKAGING WEIGHT: 6,0 kg	MINIMO ACQUISTABILE: MINIMUM ORDER: 1	PESO DEL PEZZO KIT: KIT WEIGHT: 100 g
--	--	--	--



TIPO GUIDA DIN/DIN RAIL TYPE: Norme EN 60715/EN 60715 NORM



RASPERRY PI 4
CARATTERISTICHE GENERALI
 Contenitore per RASPERRY PI 4 per applicazio-
 ne industriale su guida DIN (EN 60715)



Materiale: PC/ABS autoestinguente UL94V-0
Colore: Grigio

CONTENITORE PER GUIDA DIN (EN 60715)
 Italtronic propone una nuova linea di contenitori industriali e per HOME & BUILDING
 AUTOMATION adatti a contenere le più note schede elettroniche EMBEDDED.



RASPERRY PI 4
GENERAL FEATURES
 RASPERRY PI 4 enclosure for rail din industrial
 (EN 60715) application.



Material: PC/ABS self-extinguishing UL94V-0
Colour: Grey

DIN RAIL (EN 60715) ENCLOSURE
 Italtronic propose a new industrial and HOME & BUILDING AUTOMATION enclosures
 useful to contain the more famous EMBEDDED electronic boards.

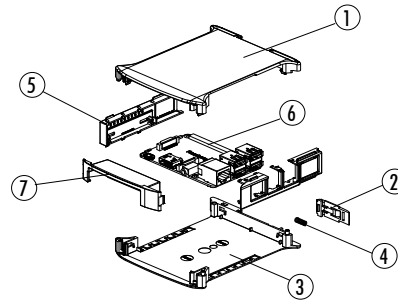

- Descrizione/Description:**
- 1) Coperchio/Cover
 - 2) Gancio/Hook
 - 3) Base/Base
 - 4) Molla/Spring
 - 5) Accessori laterali/Lateral accessories
 - 6) Circuito stampato*/Pcb*
 - 7) Pannello frontale/Front panel
- * Non incluso / Not included

Contenitore Completo/Complete Enclosure

CODICE / CODE	COLORE / COLOUR	DESCRIZIONE/DESCRIPTION	FORMA/SHAPE
10.0012225.RP4	Grigio/Grey	Kit 22,5 Railbox Raspberry PI 4/22,5 Railbox Raspberry PI 4 kit	

Composizione Kit: il Kit comprende base, coperchio, gancio, molla, accessori laterali,
 pannello frontale

Kit composition: kit includes base, cover, hook, spring, lateral accessories, front
 panel.

DIMENSIONI B/B DIMENSIONS: 22,5 mm
DIMENSIONI L/L DIMENSIONS: 101 mm
DIMENSIONI H/H DIMENSIONS: 119,5 mm

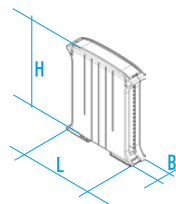

CONFEZIONE N° PCS/KIT: PACKAGING N° PCS/KIT: 50	PESO DELLA CONFEZIONE: PACKAGING WEIGHT: 4,5 kg	MINIMO ACQUISTABILE: MINIMUM ORDER: 1	PESO DEL PEZZO KIT: KIT WEIGHT: 70 g
--	--	--	---

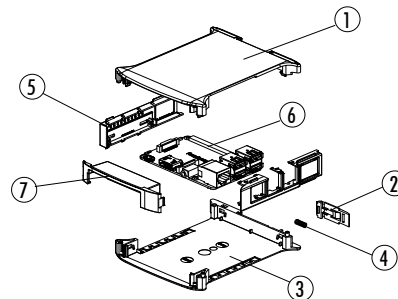

- Descrizione/Description:**
- 1) Coperchio/Cover
 - 2) Gancio/Hook
 - 3) Base/Base
 - 4) Molla/Spring
 - 5) Accessori laterali/Lateral accessories
 - 6) Circuito stampato*/Pcb*
 - 7) Pannello frontale/Front panel
- * Non incluso / Not included

Contenitore Completo/Complete Enclosure

CODICE / CODE	COLORE / COLOUR	DESCRIZIONE/DESCRIPTION	FORMA/SHAPE
10.0052450.RP4	Grigio/Grey	Kit 45 Railbox Raspberry PI 4/45 Railbox Raspberry PI 4 kit	

Composizione Kit: il Kit comprende base, coperchio, gancio, molla, accessori laterali,
 pannello frontale

Kit composition: kit includes base, cover, hook, spring, lateral accessories, front panel.

DIMENSIONI B/B DIMENSIONS: 45 mm
DIMENSIONI L/L DIMENSIONS: 101 mm
DIMENSIONI H/H DIMENSIONS: 119,5 mm

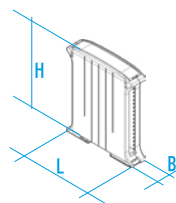

CONFEZIONE N° PCS/KIT: PACKAGING N° PCS/KIT: 50	PESO DELLA CONFEZIONE: PACKAGING WEIGHT: 5,75 kg	MINIMO ACQUISTABILE: MINIMUM ORDER: 1	PESO DEL PEZZO KIT: KIT WEIGHT: 95 g
--	---	--	---



TIPO GUIDA DIN/DIN RAIL TYPE: Norme EN 60715/EN 60715 NORM

ODROID C1

ODROID C1

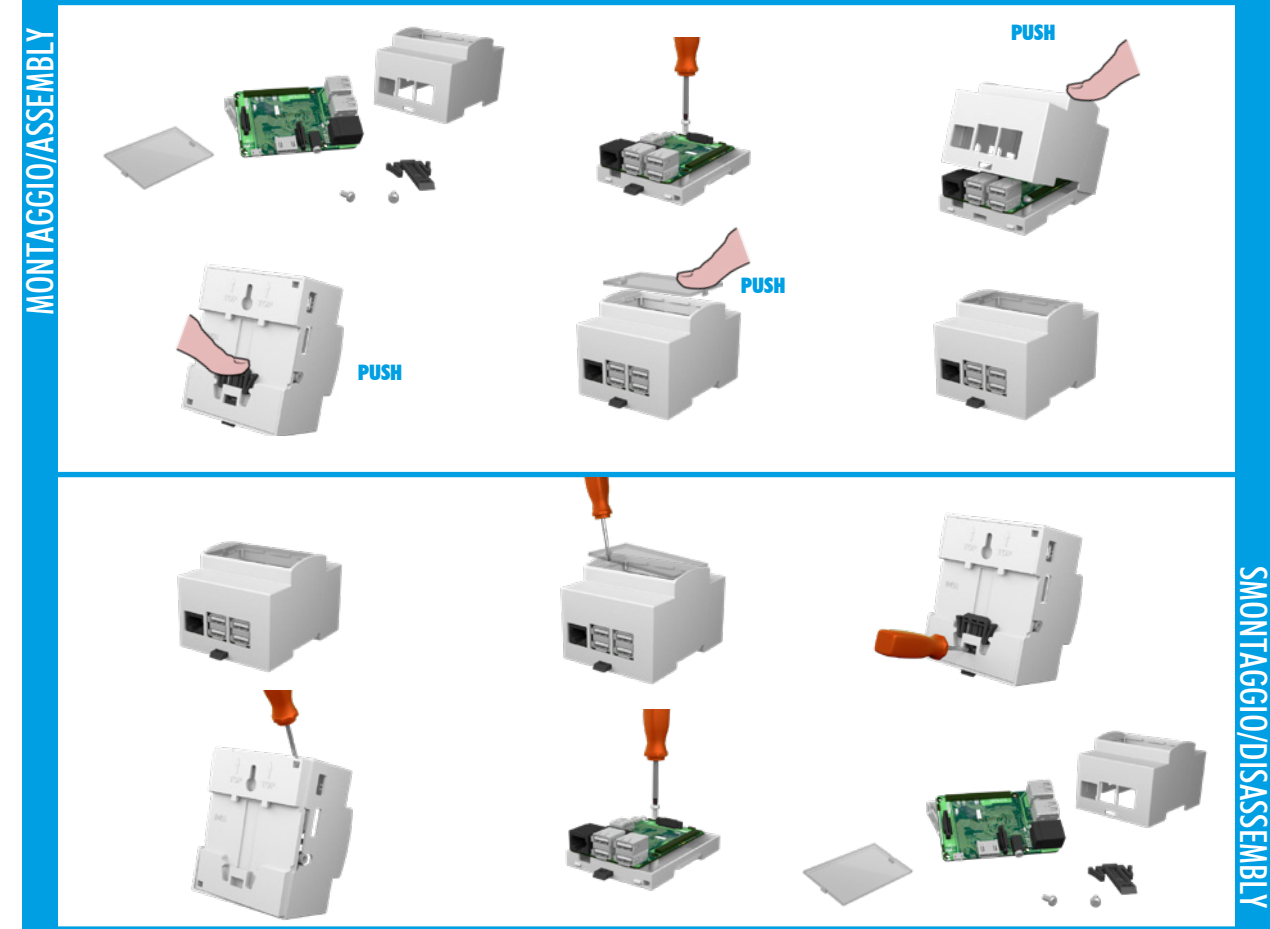

MONTAGGIO/ASSEMBLY

SMONTAGGIO/DISASSEMBLY

ODROID C1

CARATTERISTICHE GENERALI

Contenitore per ODROID C1 per guida DIN (EN 60715)

Materiale: PC/ABS autoestinguente UL94V-0
Colore: Grigio

CONTENITORE PER GUIDA DIN (EN 60715)

Italtronic propone una nuova linea di contenitori industriali e per HOME & BUILDING AUTOMATION adatti a contenere le più note schede elettroniche EMBEDDED.

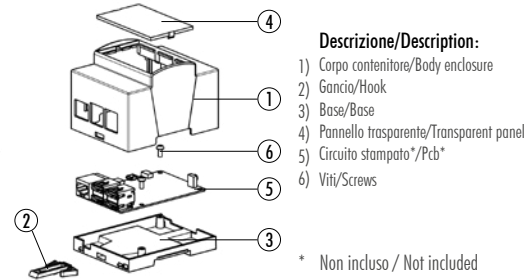

Contenitore Completo/Complete Enclosure

CODICE / CODE	COLORE / COLOUR	DESCRIZIONE/DESCRIPTION	FORMA/SHAPE
25.0410000.OC1	Grigio/Grey	Kit 4M XTS Odroid C1/4M XTS Odroid C1 kit	C/C

Composizione Kit: il Kit comprende corpo, base, gancio, pannello trasparente, 2 viti

Kit composition: kit includes body enclosure, base, hook, transparent panel, 2 screws.

DIMENSIONI B/B DIMENSIONS: 90 mm
 DIMENSIONI L/L DIMENSIONS: 71 mm
 DIMENSIONI H/H DIMENSIONS: 55 mm

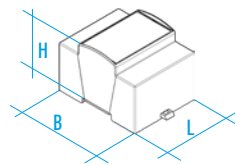

CONFEZIONE N° PCS/KIT: PACKAGING N° PCS/KIT:	PESO DELLA CONFEZIONE: PACKAGING WEIGHT:	MINIMO ACQUISTABILE: MINIMUM ORDER:	PESO DEL PEZZO KIT: KIT WEIGHT:
50	4,5 kg	1	70 g

TIPO GUIDA DIN/DIN RAIL TYPE: Norme EN 60715/EN 60715 NORM
 NORMA CONTENITORE/ENCLOSURE STANDARD: Norme DIN 43880/43880 DIN NORM



ODROID C1

GENERAL FEATURES

Enclosure ODROID C1 for rail din (EN 60715) application.

Material: PC/ABS self-extinguishing UL94V-0
Colour: Grey

DIN RAIL (EN 60715) ENCLOSURE

Italtronic propose a new industrial and HOME & BUILDING AUTOMATION enclosures useful to contain the more famous EMBEDDED electronic boards.

ASSEMBLAGGIO/DISASSEMBLAGGIO

ASSEMBLY/DISASSEMBLY

ODROID C1 +

ODROID C1 +

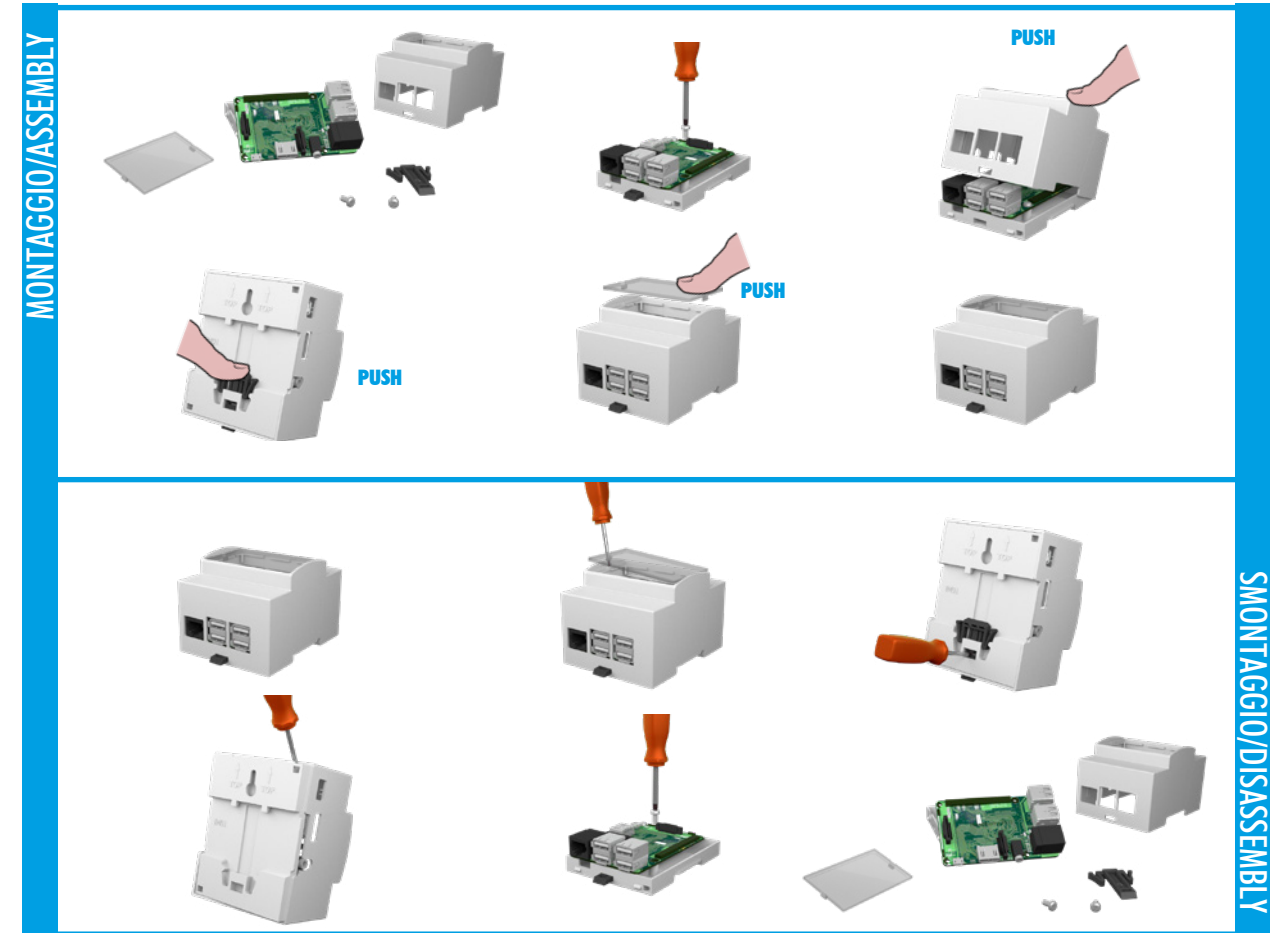

ODROID C1 +

ODROID C1 +

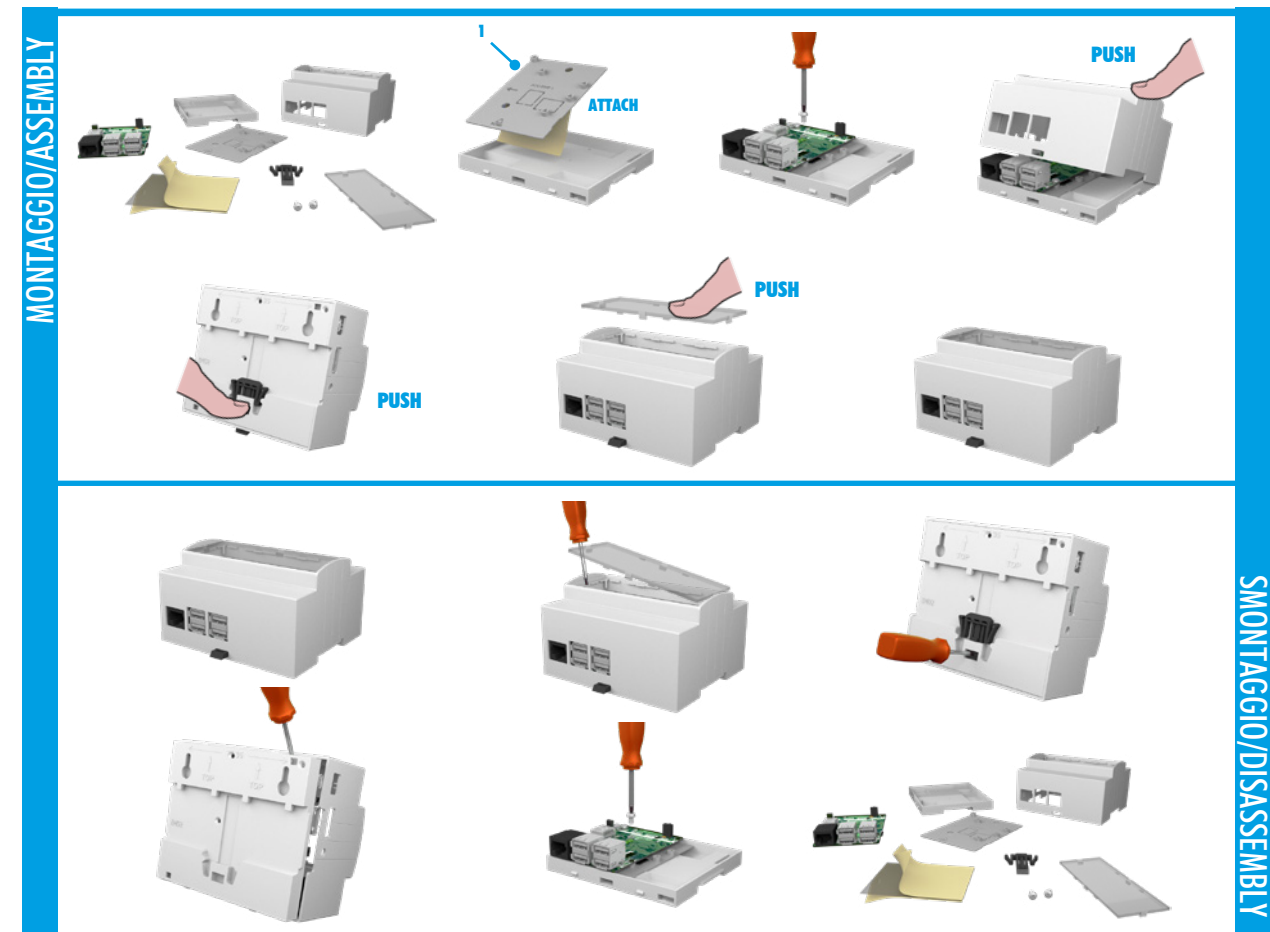

ODROID C1 + CARATTERISTICHE GENERALI Contenitore per ODROID C1+ per guida DIN (EN 60715)

Materiale: PC/ABS autoestinguente UL94V-0
Colore: Grigio

CONTENITORE PER GUIDA DIN (EN 60715)

Italtronic propone una nuova linea di contenitori industriali e per HOME & BUILDING AUTOMATION adatti a contenere le più note schede elettroniche EMBEDDED.



ODROID C1 + GENERAL FEATURES Enclosure ODROID C1+ for rail DIN (EN 60715) application

Material: PC/ABS self-extinguishing UL94V-0
Colour: Grey

DIN RAIL (EN 60715) ENCLOSURE

Italtronic propose a new industrial and HOME & BUILDING AUTOMATION enclosures useful to contain the more famous EMBEDDED electronic boards.

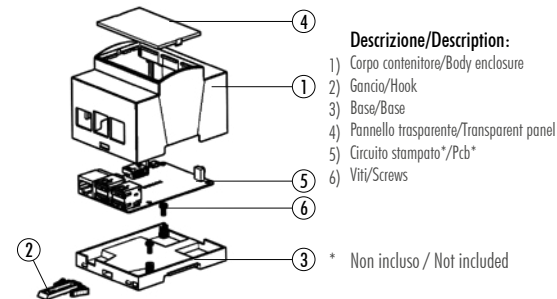

Contenitore Completo/Complete Enclosure

CODICE / CODE	COLORE / COLOUR	DESCRIZIONE/DESCRIPTION	FORMA/SHAPE
25.0410000.0CP	Grigio/Grey	Kit 4M XTS Odroid C1 +/4M XTS Odroid C1 + kit	C/C

Composizione Kit: il Kit comprende corpo, base, gancio, pannello trasp., 2 viti

Kit composition: kit includes body enclosure, base, hook, transparent panel, 2 screws

DIMENSIONI B/B DIMENSIONS: 90 mm
DIMENSIONI L/L DIMENSIONS: 71 mm
DIMENSIONI H/H DIMENSIONS: 55 mm

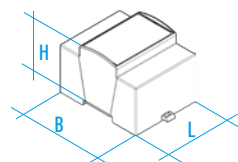

CONFEZIONE N° PCS/KIT: PACKAGING N° PCS/KIT: 50	PESO DELLA CONFEZIONE: PACKAGING WEIGHT: 4,5 kg	MINIMO ACQUISTABILE: MINIMUM ORDER: 1	PESO DEL PEZZO KIT: KIT WEIGHT: 70 g
--	--	--	---

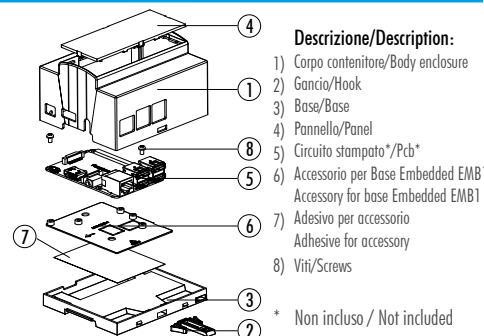

Contenitore Completo/Complete Enclosure

CODICE / CODE	COLORE / COLOUR	DESCRIZIONE/DESCRIPTION	FORMA/SHAPE
25.0610000.0CP	Grigio/Grey	Kit 6M XTS Odroid C1 +/6M XTS Odroid C1 + kit	C/C

Composizione Kit: il Kit comprende corpo, base, gancio, pannello trasp., accessorio base embedded, adesivo, 3 viti.

Kit composition: kit includes body enclosure, base, hook, transparent panel, accessory for base embedded, adhesive for accessory, 3 screws.

DIMENSIONI B/B DIMENSIONS: 90 mm
DIMENSIONI L/L DIMENSIONS: 106,5 mm
DIMENSIONI H/H DIMENSIONS: 55 mm

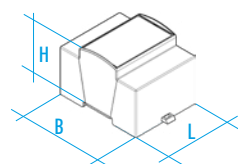

CONFEZIONE N° PCS/KIT: PACKAGING N° PCS/KIT: 25	PESO DELLA CONFEZIONE: PACKAGING WEIGHT: 3,25 kg	MINIMO ACQUISTABILE: MINIMUM ORDER: 1	PESO DEL PEZZO KIT: KIT WEIGHT: 90 g
--	---	--	---

TIPO GUIDA DIN/DIN RAIL TYPE: Norme EN 60715/EN 60715 NORM
NORMA CONTENITORE/ENCLOSURE STANDARD: Norme DIN 43880/43880 DIN NORM



ACCESSORI PER BASE EMBEDDED

CARATTERISTICHE

Adattatore Universale per schede EMBEDDED. È studiato per equipaggiare velocemente, grazie ad un biadesivo, le schede elettroniche nei nostri contenitori per guida DIN, con i quali abbiamo sviluppato le applicazioni EMBEDDED per l'industria. Però può essere impiegato da solo, oppure con altri contenitori Italtronic opportunamente modificati con lavorazioni meccaniche CNC.

EMB 1

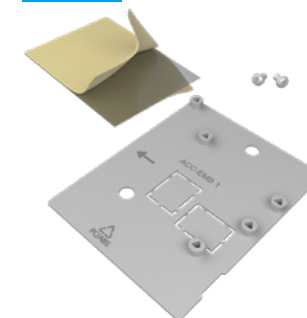

Contenitore Completo/Complete Enclosure

CODICE / CODE	DESCRIZIONE/DESCRIPTION
25.000EMB1	Kit accessorio per base embedded EMB 1/Accessory for Embedded base EMB 1

Composizione Kit: L'accessorio può accogliere le schede Embedded: Raspberry Pi B+/Pi 3/A+/Pi ZERO e Odroid C1/C1+.

Kit composition: The accessory can accommodate Embedded boards: Raspberry Pi B+/Pi 3/A+/Pi ZERO e Odroid C1/C1+.

CONFEZIONE N° PCS/KIT: PACKAGING N° PCS/KIT: 25	PESO DELLA CONFEZIONE: PACKAGING WEIGHT: 0,6 kg	MINIMO ACQUISTABILE: MINIMUM ORDER: 1	PESO DEL PEZZO KIT: KIT WEIGHT: 20 g
--	--	--	---

EMB 2

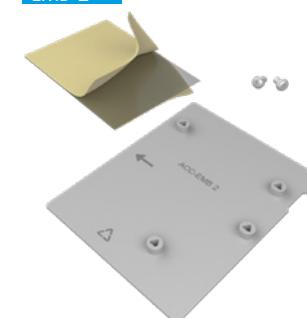

Contenitore Completo/Complete Enclosure

CODICE / CODE	DESCRIZIONE/DESCRIPTION
25.000EMB2	Kit accessorio per base embedded EMB 2/Accessory for Embedded base EMB 2

Composizione Kit: L'accessorio può accogliere le schede Embedded: Arduino Yun, Arduino UNO/101 e Arduino ZERO.

Kit composition: The accessory can accommodate Embedded boards: Arduino Yun, Arduino UNO/101 e Arduino ZERO.

CONFEZIONE N° PCS/KIT: PACKAGING N° PCS/KIT: 25	PESO DELLA CONFEZIONE: PACKAGING WEIGHT: 0,6 kg	MINIMO ACQUISTABILE: MINIMUM ORDER: 1	PESO DEL PEZZO KIT: KIT WEIGHT: 20 g
--	--	--	---

EMB 3

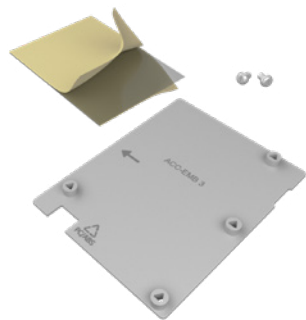

Contenitore Completo/Complete Enclosure

CODICE / CODE	DESCRIZIONE/DESCRIPTION
25.000EMB3	Kit accessorio per base embedded EMB 3/Accessory for Embedded base EMB 3

Composizione Kit: L'accessorio può accogliere le schede Embedded: Beaglebone Black e Beaglebone Green. **Kit composition:** The accessory can accommodate Embedded boards: Beaglebone Black e Beaglebone Green.

CONFEZIONE N° PCS/KIT: PACKAGING N° PCS/KIT: 25	PESO DELLA CONFEZIONE: PACKAGING WEIGHT: 0,6 kg	MINIMO ACQUISTABILE: MINIMUM ORDER: 1	PESO DEL PEZZO KIT: KIT WEIGHT: 20 g
--	--	--	---

EMB 4

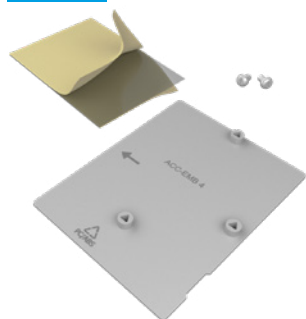

Contenitore Completo/Complete Enclosure

CODICE / CODE	DESCRIZIONE/DESCRIPTION
25.000EMB4	Kit accessorio per base embedded EMB 4/Accessory for Embedded base EMB 4

CONFEZIONE N° PCS/KIT: PACKAGING N° PCS/KIT: 25	PESO DELLA CONFEZIONE: PACKAGING WEIGHT: 0,6 kg	MINIMO ACQUISTABILE: MINIMUM ORDER: 1	PESO DEL PEZZO KIT: KIT WEIGHT: 20 g
--	--	--	---

FINISHING SERVICE

ITALTRONIC è da tempo impegnata nella fornitura dei propri contenitori completi di servizi aggiuntivi vari per il completamento dei prodotti esteticamente e meccanicamente. Per fare ciò si è dotato di un ufficio tecnico che può tradurre le note della clientela in disegni esecutivi prima e in campionature per la valutazione finale della corrispondenza al progetto.

Alcuni servizi sono completamente GRATUITI, cioè quando il cliente fornisce dei documenti tecnici già conformi al post process che ITALTRONIC dovrà fare, altri invece sono a pagamento: generalmente quando ITALTRONIC deve sviluppare un progetto sui propri contenitori oppure adattare le informazioni ricevute agli STANDARD necessari per avviare la produzione.

Qui di seguito troverete una semplice traccia di quelle che sono le richieste minime di ITALTRONIC affinché la gestione possa essere veloce, semplice e gratuita, fatto salvo i costi di attrezzatura di base; altrimenti saranno addebitati i costi relativi alle attività svolte dai tecnici ITALTRONIC al puro costo aziendale.

PERSONALIZZAZIONE MECCANICA

Siamo in grado di fornire un servizio di personalizzazione meccanica del prodotto con l'ausilio di macchine per fresatura CNC, taglio e troncatura.

Lavorazioni meccaniche su superfici: ABS, PC/ABS, PPO, PC, PMMA, PA

FINISHING SERVICE

For years ITALTRONIC has been working to supply its enclosures with the various additional services to complete the products both externally and mechanically. To do this, we have set up our technical office that is able to translate our customers' notes into initial project drawings and samples to enable a final evaluation of whether they correspond to the project.

Some services are FREE OF CHARGE, i.e. when the customer gives us the technical documents that already conform to the post processing ITALTRONIC has to do, while others are for a fee: usually when ITALTRONIC has to develop a project on its own enclosures, or adapt the information received to the necessary production STANDARDS.

Below you will find a simple guide of the ITALTRONIC minimum requests so that the process can be quick, simple and free, apart from the basic equipment costs, otherwise we will charge you for the work of our ITALTRONIC technicians at the pure cost price.

MECHANICAL PERSONALIZATION

We can supply a product mechanical personalization service with the aid of milling, CNC, cutting and trenching machines.

Mechanical processing: on ABS, PC/ABS, PPO, PC, PMMA, PA surfaces

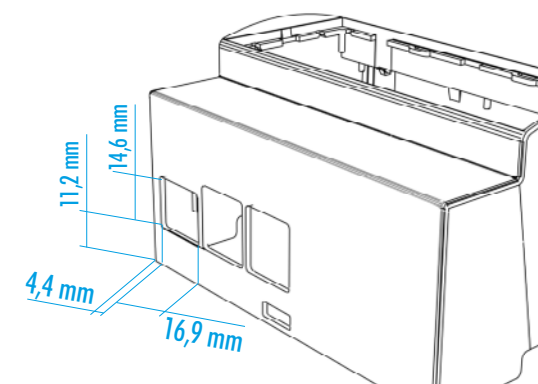

SPECIFICHE TECNICHE RICHIESTE

File: .dwg, .dxf o STEP

Dimensioni: Scala 1:1

In caso contrario, verranno addebitati i costi in base alla complessità nel creare un file di lavorazione. Come modello per la creazione di un file abbiamo bisogno di un disegno/schizzo che contenga tutte le dimensioni di lavorazione pertinenti.

TECHNICAL SPECS REQUEST

File: .dwg, .dxf o STEP

Dimensions: 1:1 scale

Otherwise, additional costs will be charged, according to the complexity of the print file preparation. As guideline for the final print file, we need to have a drawing / sketch showing all pertinent working dimensions.

EXTRA COST



OK



EXTRA COST



SPECIFICHE TECNICHE GARANTITE

Centraggio delle lavorazioni

La centratura di tutte le lavorazioni eseguite da Italtronic è sottoposta a un controllo finale con uno strumento semplice come il calibro.

GUARANTED TECHNICAL SPECS

Centring the work

The centring for all the work by Italtronic undergoes a final control using a simple tool, like a gauge.

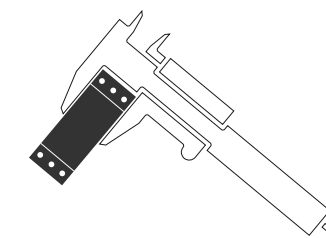

COME QUOTARE E CONTROLLARE LE MISURE DELLE LAVORAZIONI

Qui sotto riportiamo un esempio di come possono essere eseguite delle misure affinché risultino centrate con altri processi, come quello di STAMPA, e siano ortogonali ai piani di riferimento dei nostri prodotti.

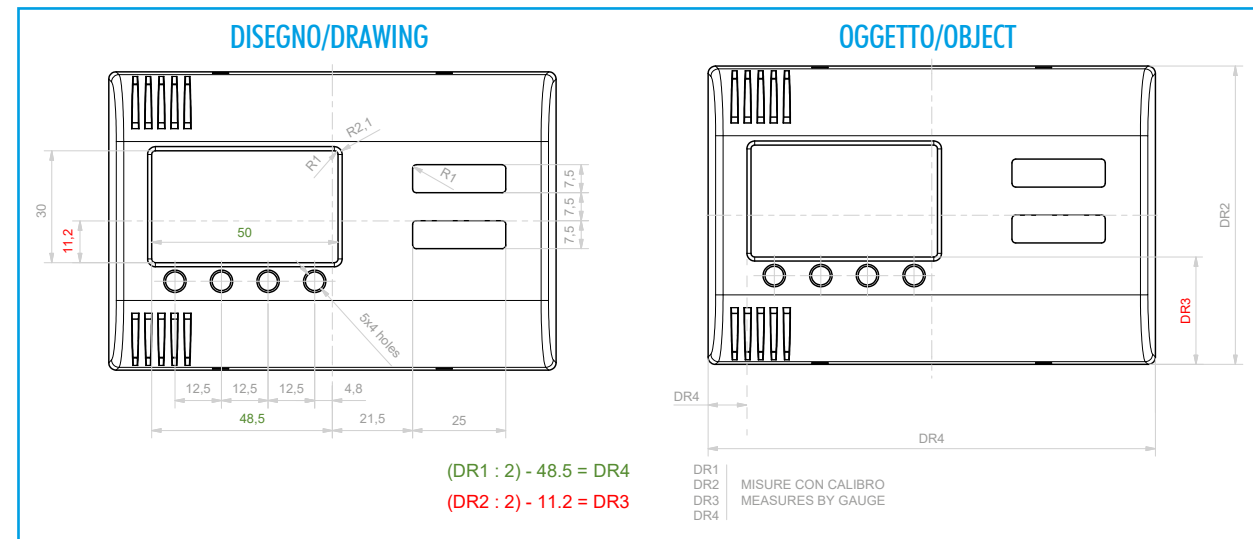

HOW TO QUOTE AND TO CHECK THE MACHINING DIMENSIONS

Below is an example of how the measurements can be taken so that they are centred with other processes, such as PRINT, and are at right angles to the reference surfaces of our products.

SVASATURE E RIBASSI

ITALTRONIC offre un ottimo servizio di finitura meccanica adatta a migliorare l'estetica del prodotto, con svasature e ribassi.

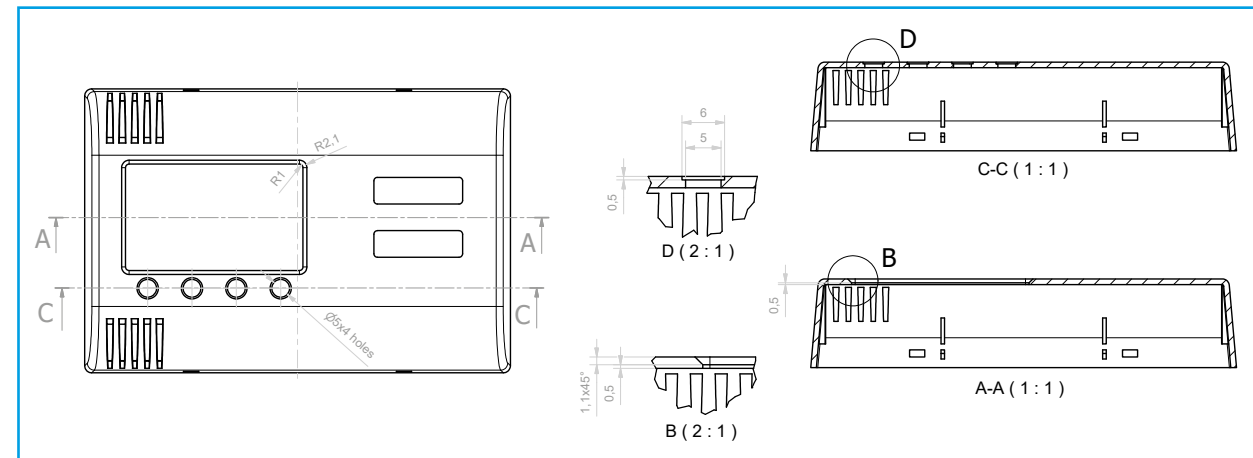

FLARING & LOWERING

ITALTRONIC offers a very good mechanical Finishing Service for a better aesthetics result of the products, with flaring and lowering.

Le tolleranze dimensionali possono essere ristrette se indicate nel disegno del cliente e se compatibili con i nostri processi produttivi: la fornitura del nostro disegno controfirmato fa da garanzia.

The size tolerances can be less if they are indicated in the customer's drawing and are compatible with our production processes: the supply of our countersigned drawing guarantees this.

Tolleranze dimensionali/Tolerance limits

Secondo tolleranze generali UNI EN 22768/1 media (m):	Average tolerances as per UNI EN 22768/1 medium (m):
DA 0.5 A 3 mm/FROM 0.5 TO 3mm	±0.1 mm
DA 3 FINO A 6 mm/FROM 3 TO 6mm	±0.1 mm
OLTRE 6 FINO A 30 mm/BEYOND 6 AND UP TO 30 mm	±0.2 mm
OLTRE 30 FINO A 120 mm/BEYOND 30 AND UP TO 120 mm	±0.3 mm
OLTRE 120 FINO A 400 mm/BEYOND 120 AND UP TO 400 mm	±0.5 mm

PERSONALIZZAZIONE GRAFICA

ITALTRONIC fornisce un ottimo servizio di personalizzazione grafica sui propri prodotti. È opportuno prendere visione delle note più sotto per ottenere risposte veramente veloci e costi ridotti al minimo.

Nota: Tutti i contenuti devono essere modificabili (generalmente i file non vettoriali non sono modificabili)

In caso contrario, verranno addebitati i costi in base alla complessità nel creare un file di stampa. Per la creazione di un file di stampa a partire da zero abbiamo bisogno di un disegno / schizzo che contenga tutte le dimensioni di lavorazione pertinenti. Se non è possibile fornire i loghi, i simboli (come file di immagine, ad es. Jpg con risoluzione min. 1200 dpi) o eventuali caratteri speciali, sono possibili lievi non conformità.

DOCUMENTAZIONE TECNICA RICHIESTA DA ITALTRONIC

File di stampa ottimale: layout deve sempre essere una grafica vettoriale (no grafica raster) in formato Adobe Illustrator, EPS, file .pdf vettoriale o Corel Draw.

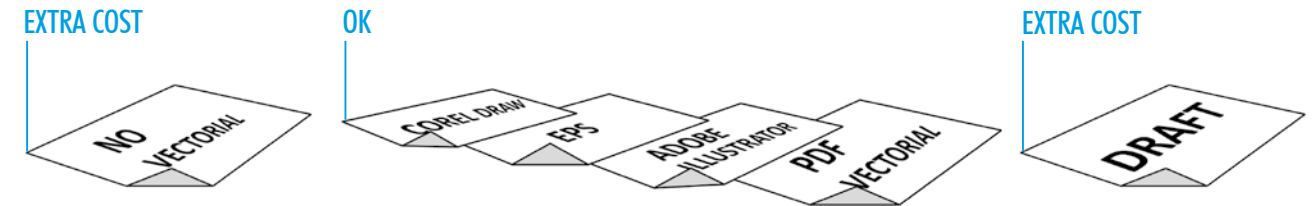

Nel caso in cui parte del file (o tutto il file non sia vettoriale, potremo accettare file con le caratteristiche: scala 1:1, inclusi file di immagine, ad esempio jpg o bmp risoluzione minima 1200 dpi.

GRAPHIC PERSONALIZATION

ITALTRONIC provides an excellent customised graphic service on its products. Read the notes below for a quick answer and costs reduced to the minimum.

Note: All contents must be editable (non-vector files usually cannot be modified)

Otherwise, additional costs will be charged, according to the complexity of the print file preparation. In order to create a print file from scratch, we need to have a drawing / sketch showing all pertinent working dimensions. If it is not possible to supply logos, symbols (in image-format files, such as jpg, with a minimum resolution of 1200 dpi) as well as any special non-standard characters, slight differences should be expected.

TECHNICAL DOCUMENTATION REQUIRED BY ITALTRONIC

Optimal print file: the layout must always be a vector graphic (no raster graphic) in Adobe Illustrator EPS format, vector PDF or Corel Draw.

In case part of the file (or the entire file) is not a vector graphic, we may consider files having the following characteristics: scale 1:1, including image files such as jpg or bmp, 1200 dpi minimal resolution.



Nota: Esempio file immagine alta risoluzione (1200 dpi)
Note: High resolution image file example (1200 dpi)

Nota: Esempio file immagine bassa risoluzione (< 1200 dpi)
Note: Low resolution image file example (< 1200 dpi)

SPECIFICHE TECNICHE GARANTITE
CENTRAGGIO DELLE STAMPE

La centratura di tutte le lavorazioni eseguite da ITALTRONIC è sottoposta a un controllo finale con uno strumento semplice come il calibro.

Qui sotto riportiamo un esempio di come possono essere eseguite delle misure affinché risultino centrate con altri processi, come quello di CNC, e siano ortogonali ai piani di riferimento dei nostri prodotti.

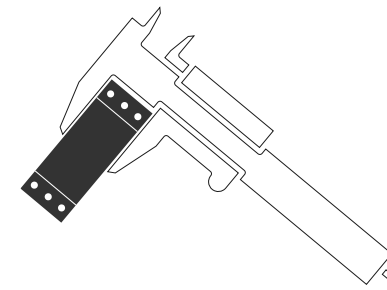

Le tolleranze possono essere ristrette se indicate nel disegno del cliente e se compatibili con i nostri processi produttivi: la fornitura del nostro disegno controfirmato fa da garanzia.

GUARANTED TECHNICAL SPECS
PRINTING CENTRING

The centring for all the work by Italtronic undergoes a final control using a simple tool, like a gauge.

Below is an example of how the measurements can be taken so that they are centred with other processes, such as CNC, and are at right angles to the reference surfaces of our products.

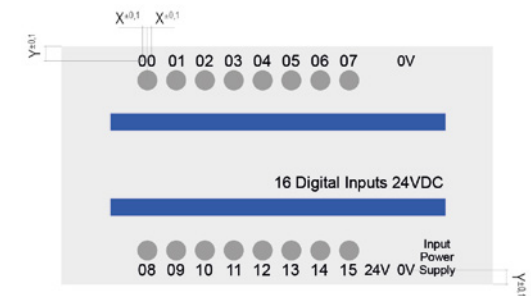

The size tolerances can be less if they are indicated in the customer's drawing and are compatible with our production processes: the supply of our countersigned drawing guarantees this.

Tolleranze dimensionali/Tolerance limits

Con stampa di forma (mm) secondo tolleranze generali UNI EN 22768/1 media (m):	With dye (mm) printing having average tolerances as per UNI EN 22768/1 medium (m):
DA 0.5 A 3 mm/FROM 0.5 TO 3 mm	±0.1 mm
DA 3 FINO A 6 mm/FROM 3 TO 6 mm	±0.1 mm
OLTRE 6 FINO A 30 mm/BEYOND 6 AND UP TO 30 mm	±0.2 mm
OLTRE 30 FINO A 120 mm/BEYOND 30 AND UP TO 120 mm	±0.3 mm
OLTRE 120 FINO A 400 mm/BEYOND 120 AND UP TO 400 mm	±0.5 mm
VARIAZIONI PERMESSE/PERMITTED VARIATIONS	Ampiezza della linea ± 10%/Line extent ± 10%
TOLLERANZA DI SPAZI VUOTI/EMPTY SPACE TOLERANCE	Contorno esterno e ritagli (mm) ± 0.3*/External contour and cropping (mm) ± 0.3*

italtronic
enclosures for electronics

Italtronic Srl

Corso Stati Uniti 17
35127 Padova - Italy
T. +39 049 8947150
F. +39 049 8947151
www.italtronic.com

