

Wireless Charging Pocket

VW Golf VII 2012>

241320-65-1



WIRELESS CHARGING

D

EINBAUANLEITUNG

Schwierigkeitsgrad

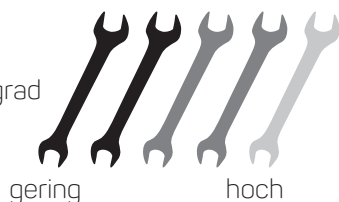

gering

hoch

GB

INSTALLATION GUIDE

level of difficulty



low

high

A

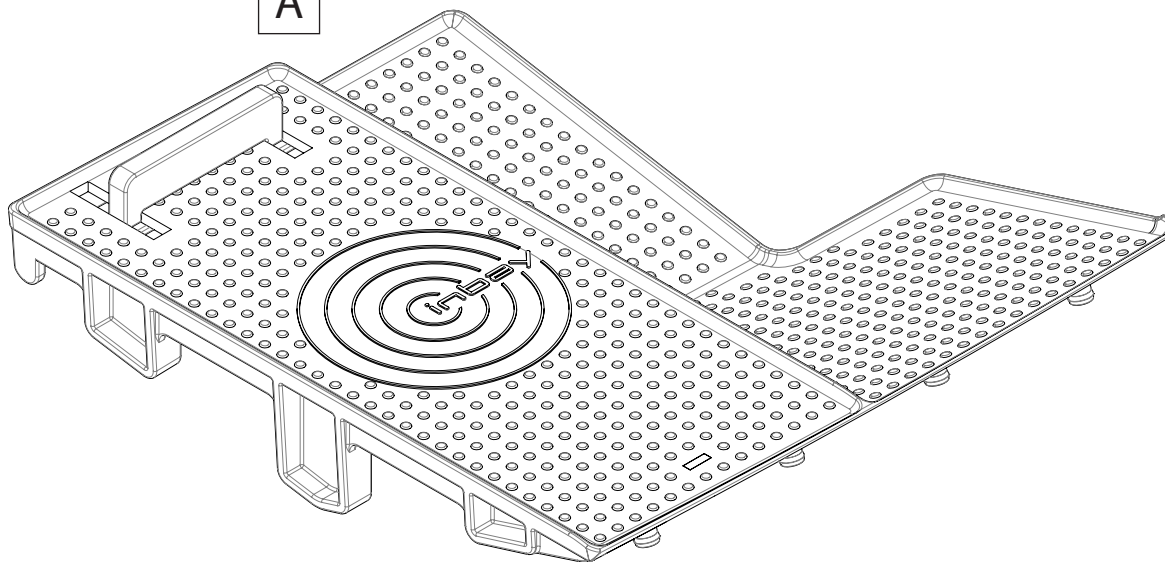

B

Seite: 2-13
Page: 2-13

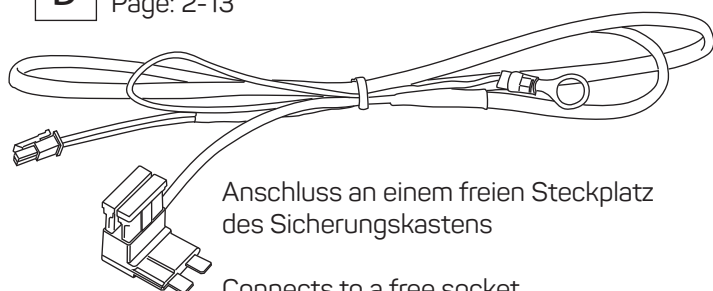

Anschluss an einem freien Steckplatz
des Sicherungskastens

Connects to a free socket
of the fuse holder box

C

Seite: 14-35
Page: 14-35

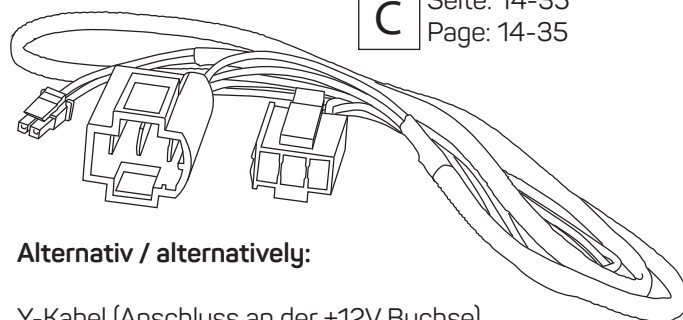

Alternativ / alternatively:

Y-Kabel (Anschluss an der +12V Buchse)
Y-Cable (Connects to the +12V socket)

Sachgemäße Installation unter Beachtung dieser Einbauanleitung erforderlich. Achten Sie auf korrekte Anschlüsse. Verlegen Sie die Kabel so, dass Sie weder geknickt, gequetscht oder beschädigt werden können. Sorgen Sie dafür, dass sich die Kabel nicht in Gegenständen verfangen können.

Wir können keine Haftung für Schäden übernehmen, welche durch unsachgemäße Installation oder Nutzung verursacht wurden. Verwenden Sie darum ausschließlich das mitgelieferte Montagematerial.

Technische Änderungen vorbehalten, alle Angaben ohne Gewähr.

Das „Qi“ Logo ist Warenzeichen des „Wireless Power Consortium“

An appropriate installation in observance of these operating instructions is necessary. Please make sure the wiring is arranged so it is not bended or crimped due to the risk of cable break. Make sure that all connections are correct. Route the cable away from moving parts, do not allow the cable to be entangled, pinched or damaged in any way.

We will not be liable for damage due to improper installation or utilization. Use the specified accessory parts to prevent product failure.

Subject to technical modifications; no responsibility is accepted for the accuracy of this information.

The “Qi” symbol is a trademark of the “Wireless Power Consortium”





ACHTUNG!
Die gelbe 20A Sicherung muss sich genau an dieser Position befinden !

IMPORTANT!
The yellow 20A fuse has to be exactly in this position !

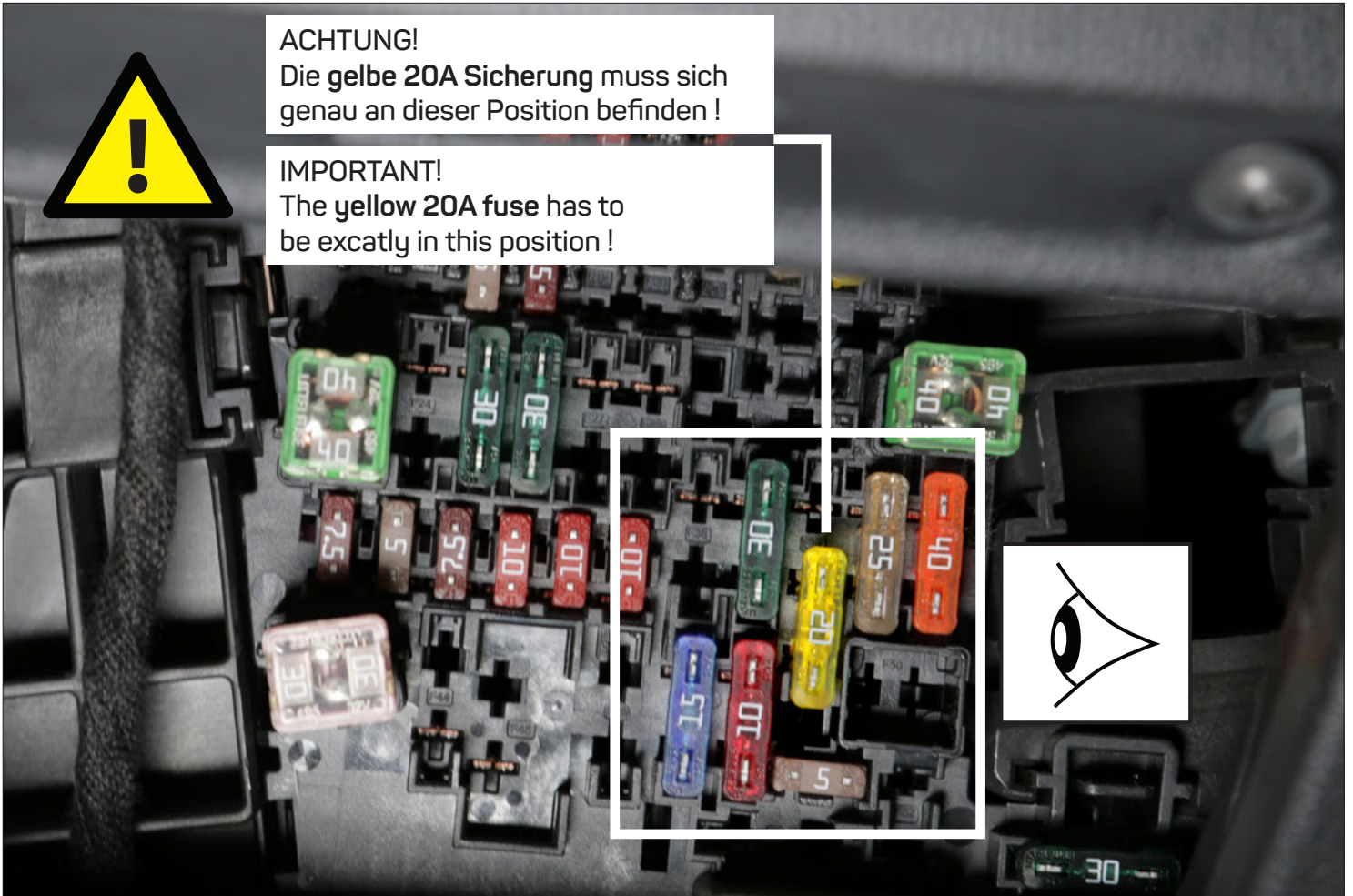

Falls sich die 20A Sicherung an einer anderen Position befinden sollte, stecken Sie diese um !

Switch the place of the 20A fuse if it is at this position !

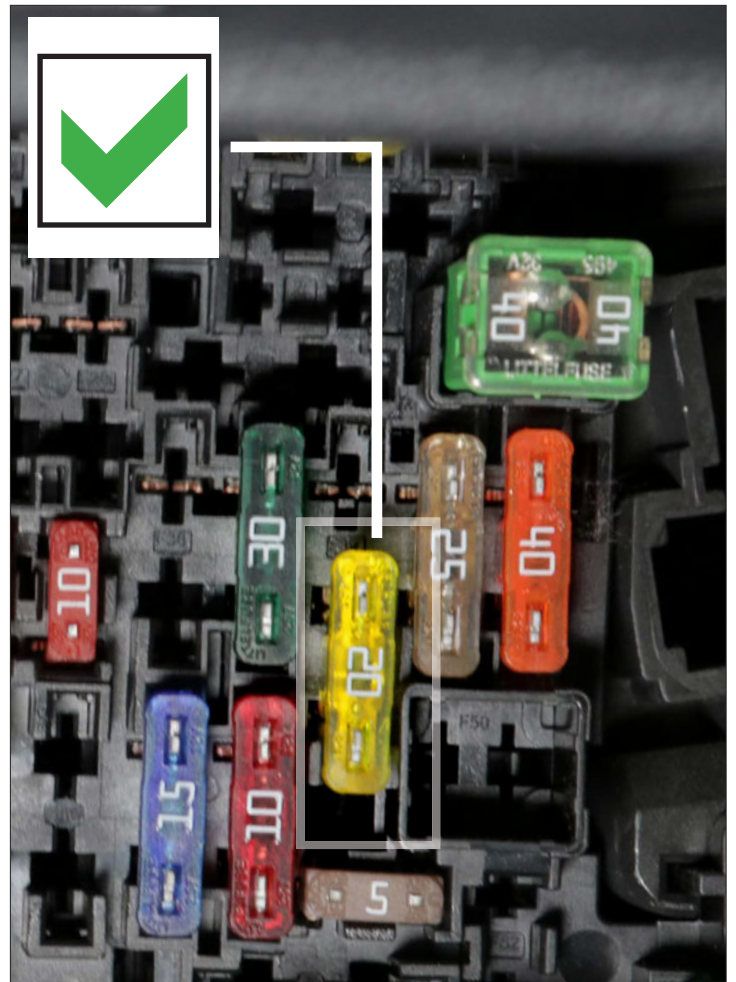
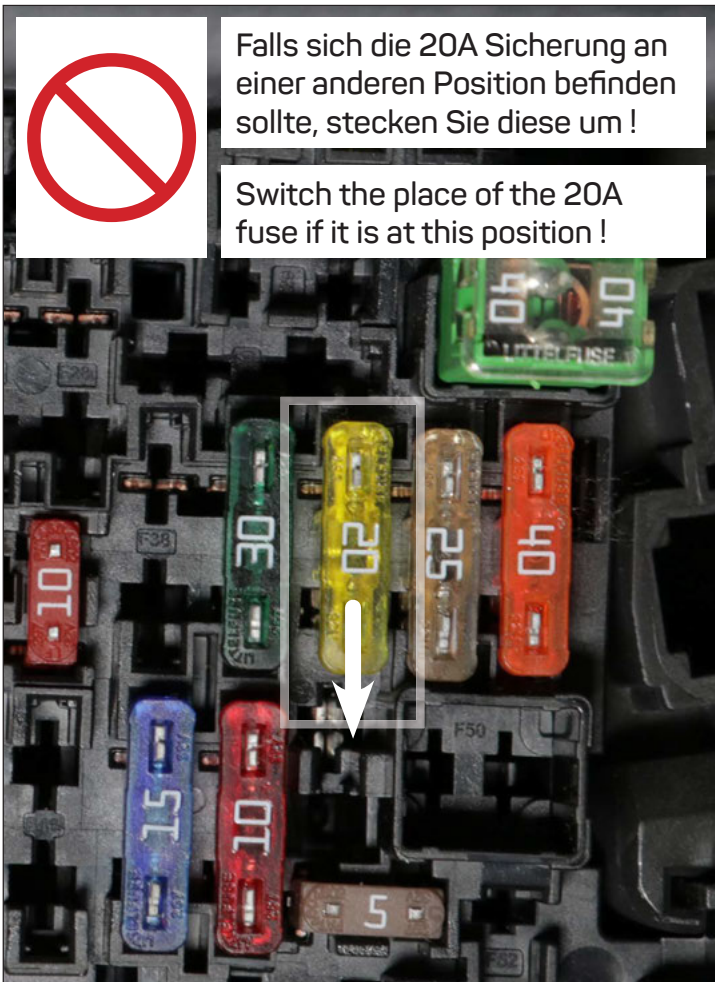

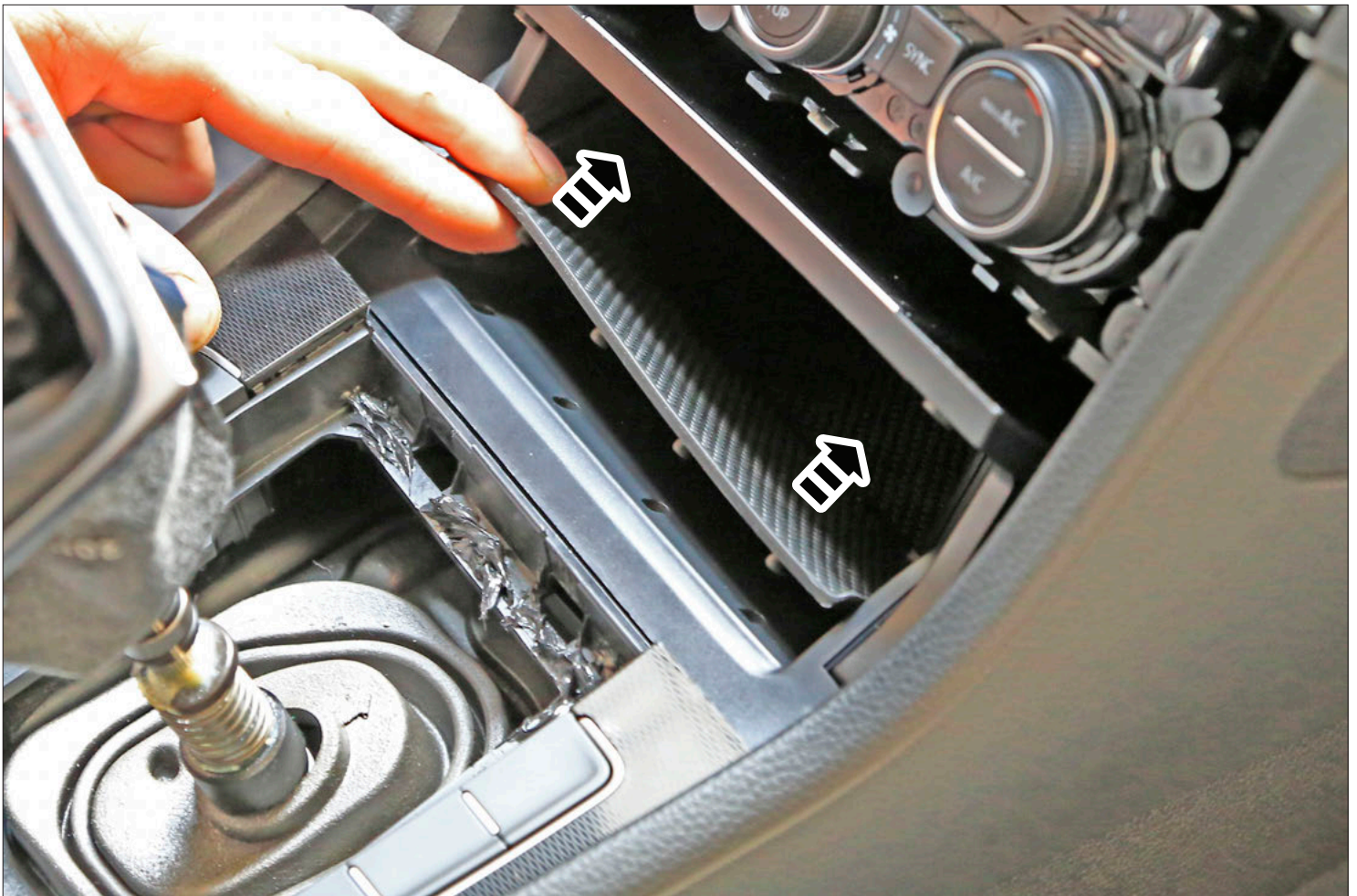
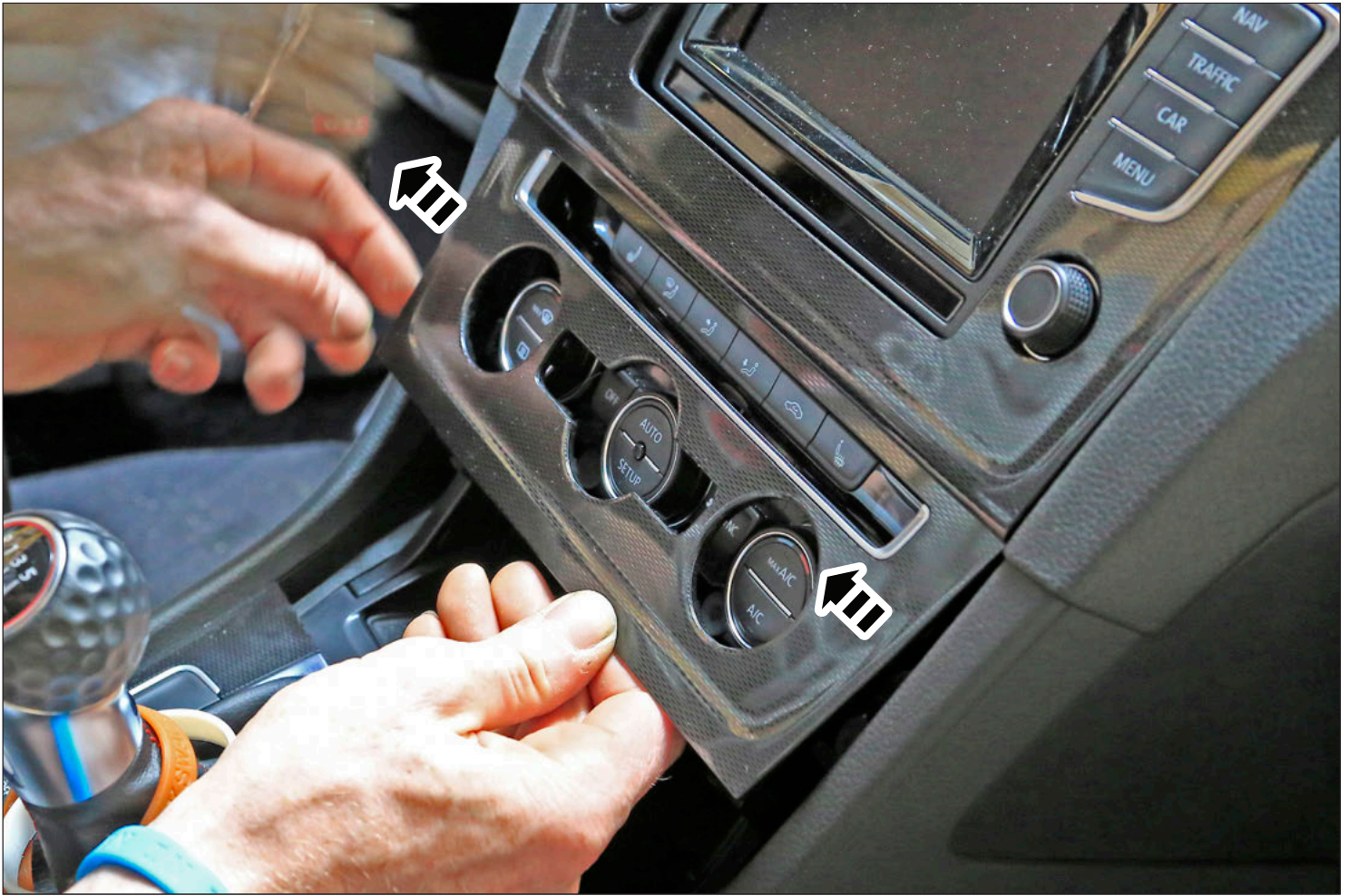

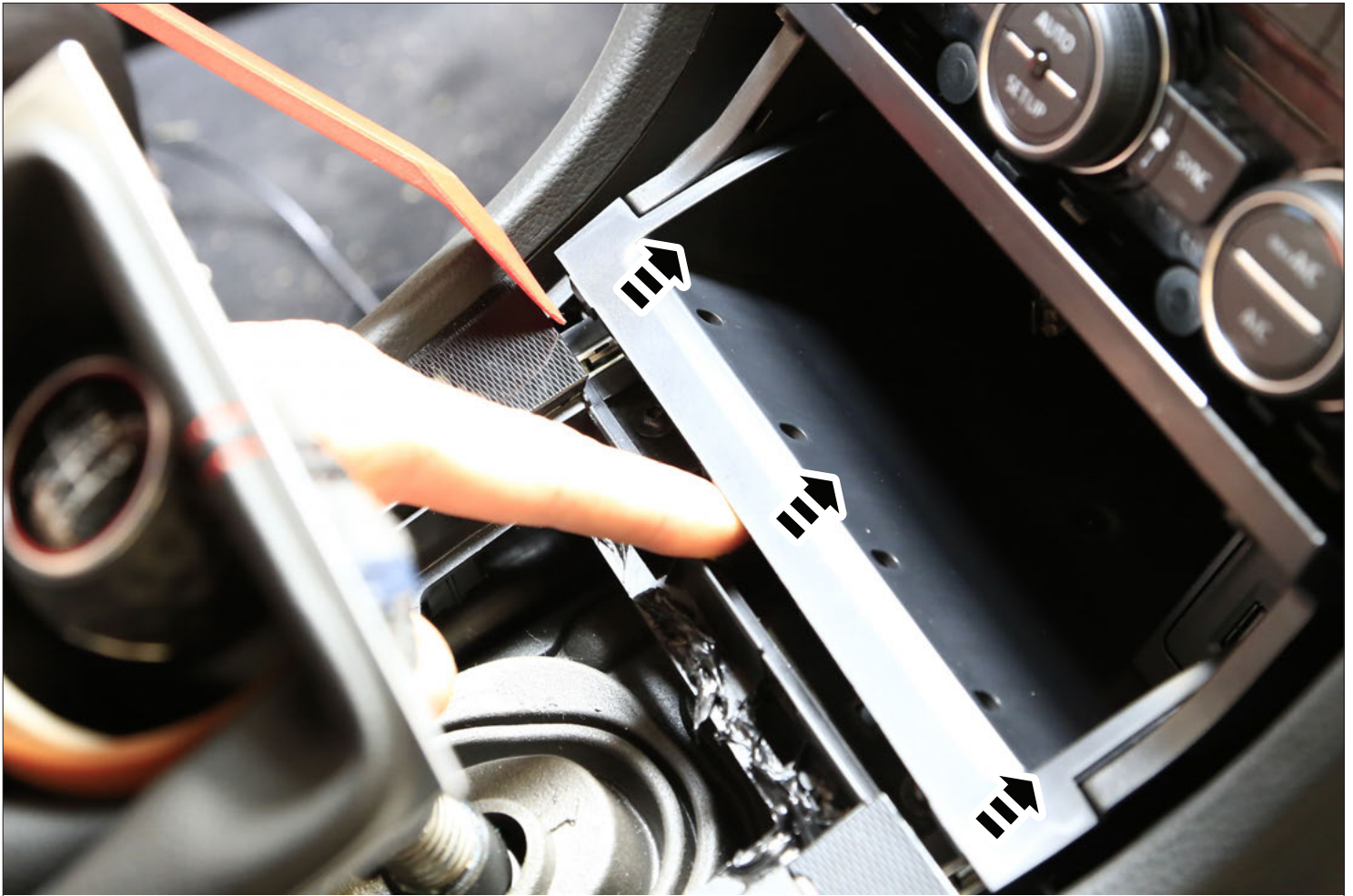

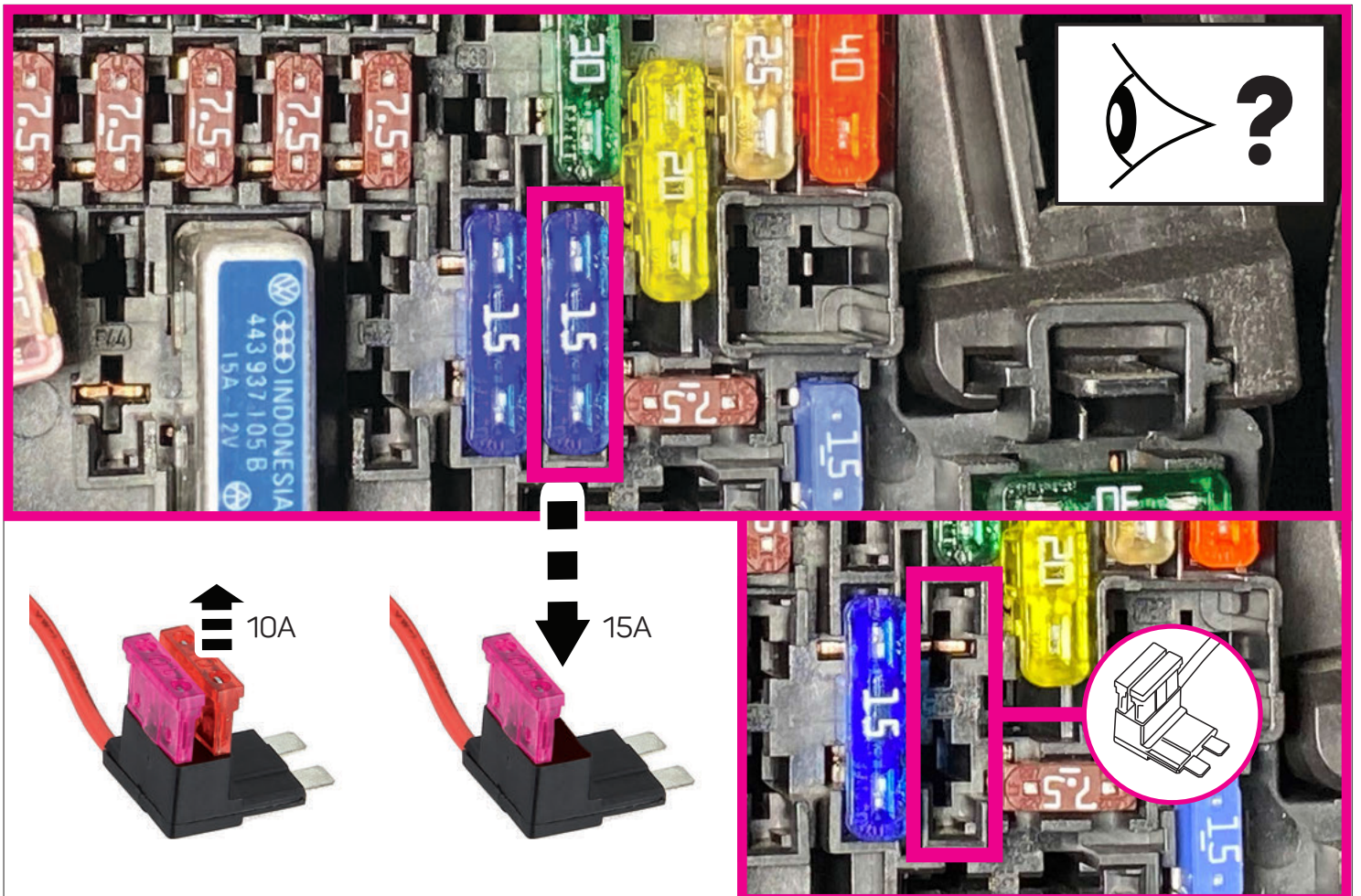
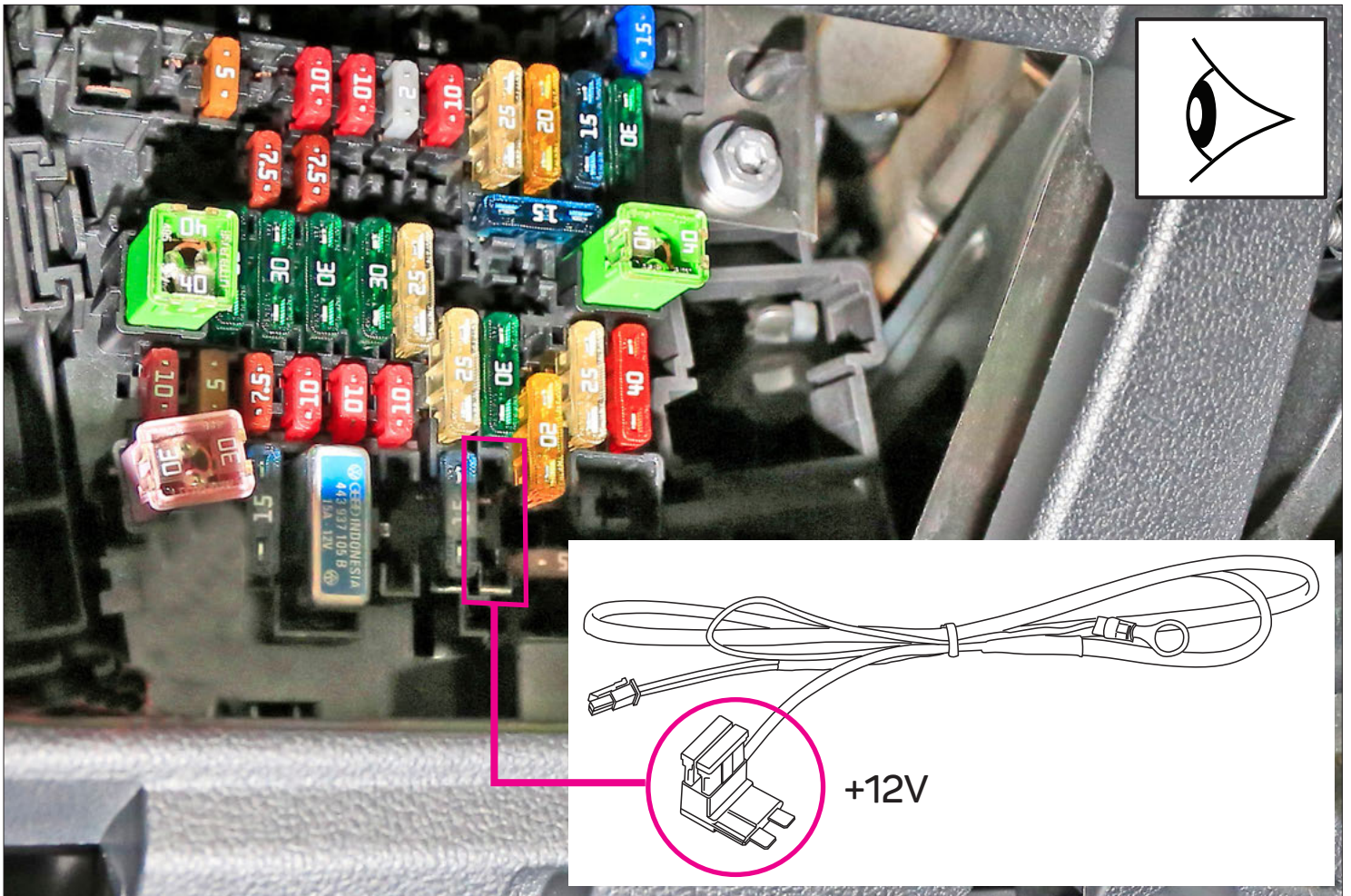

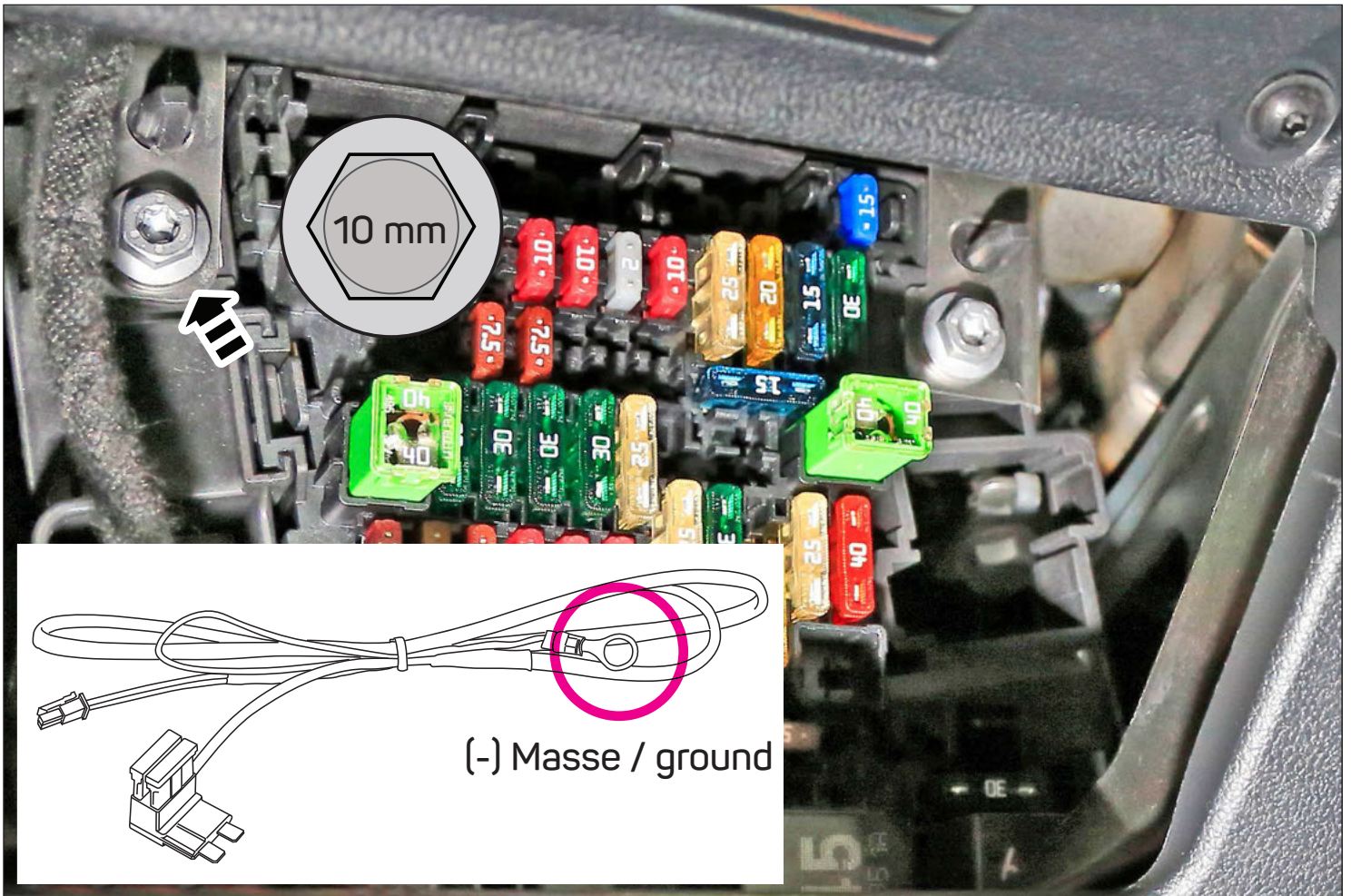

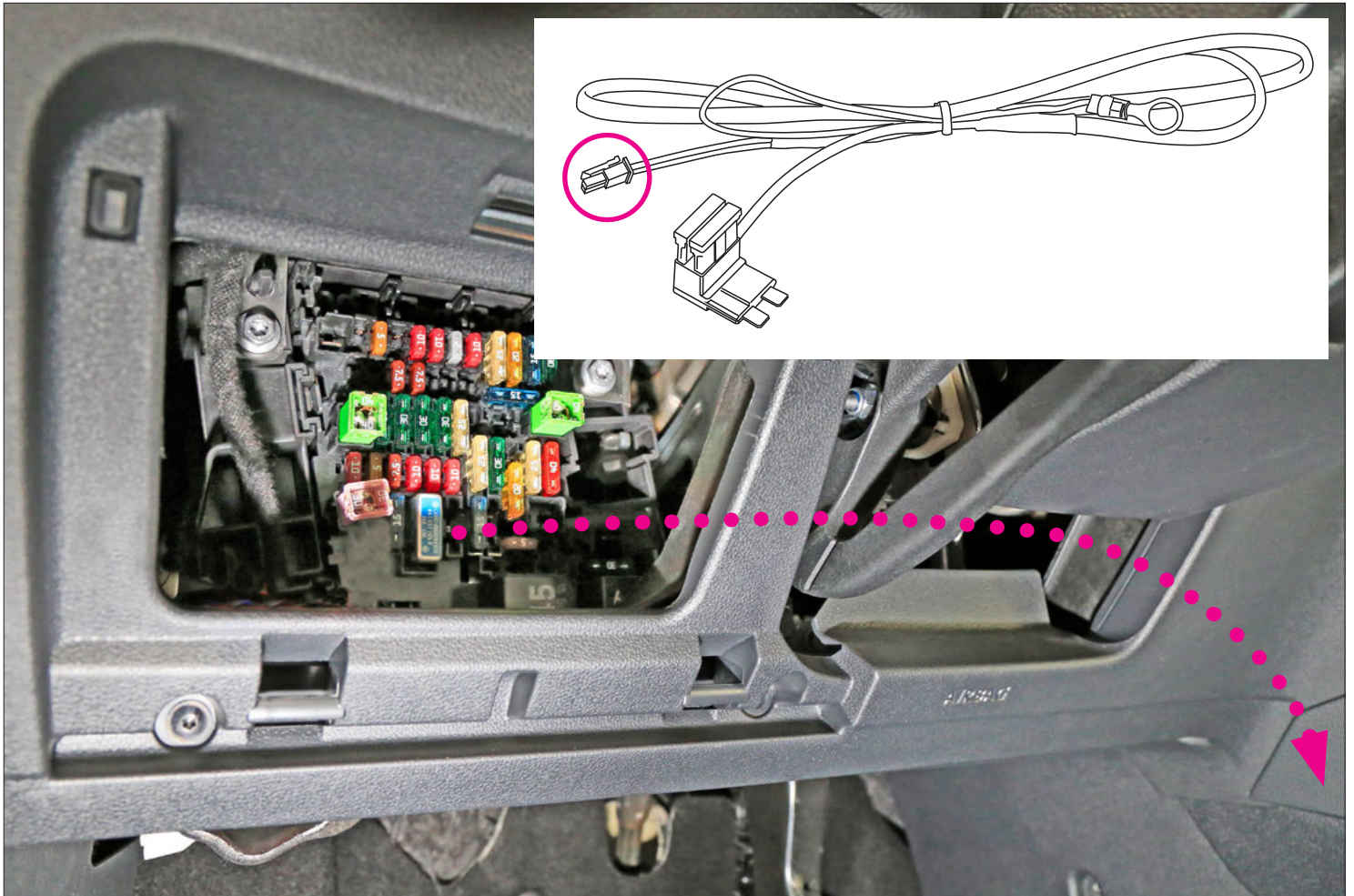

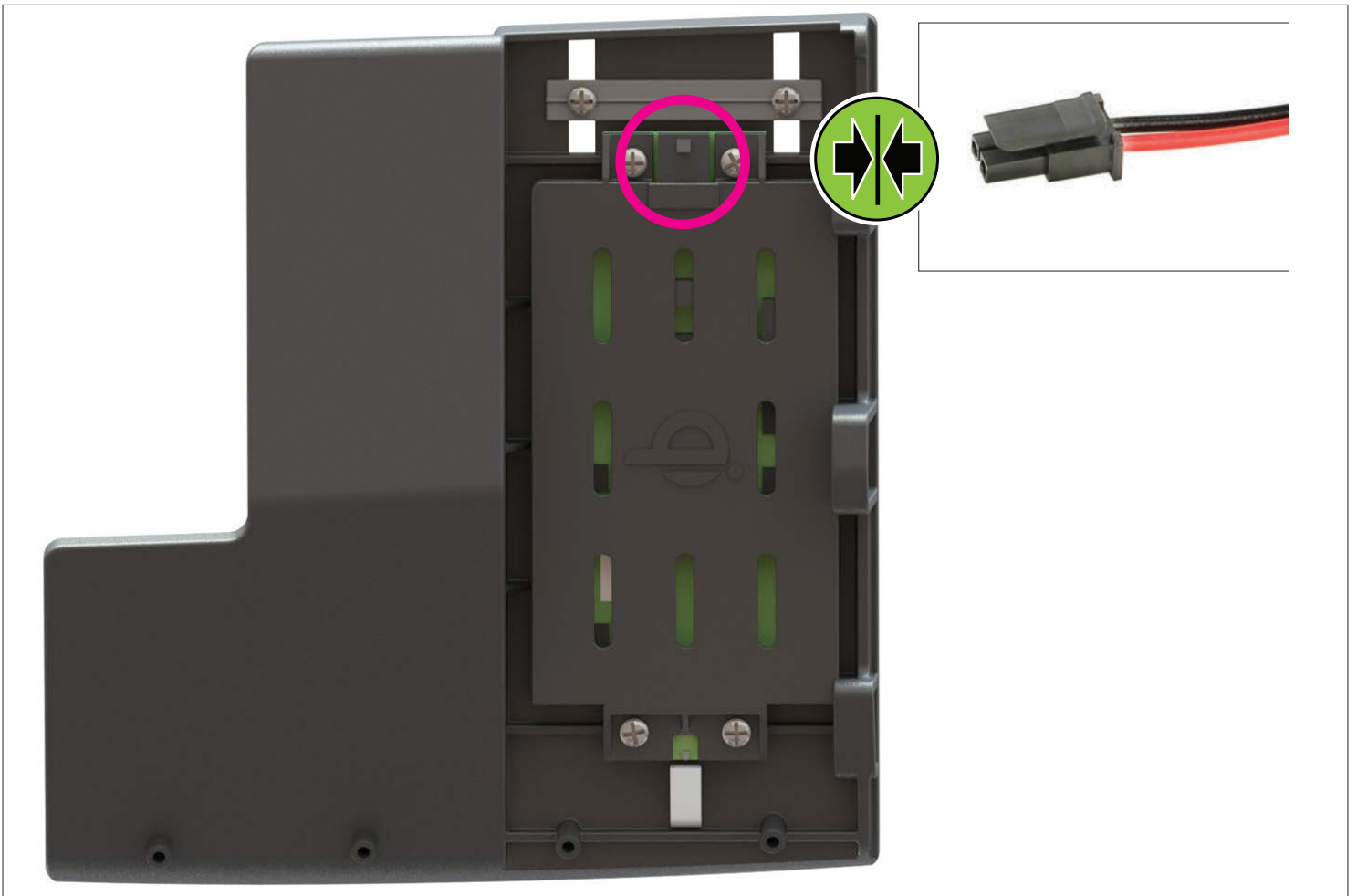
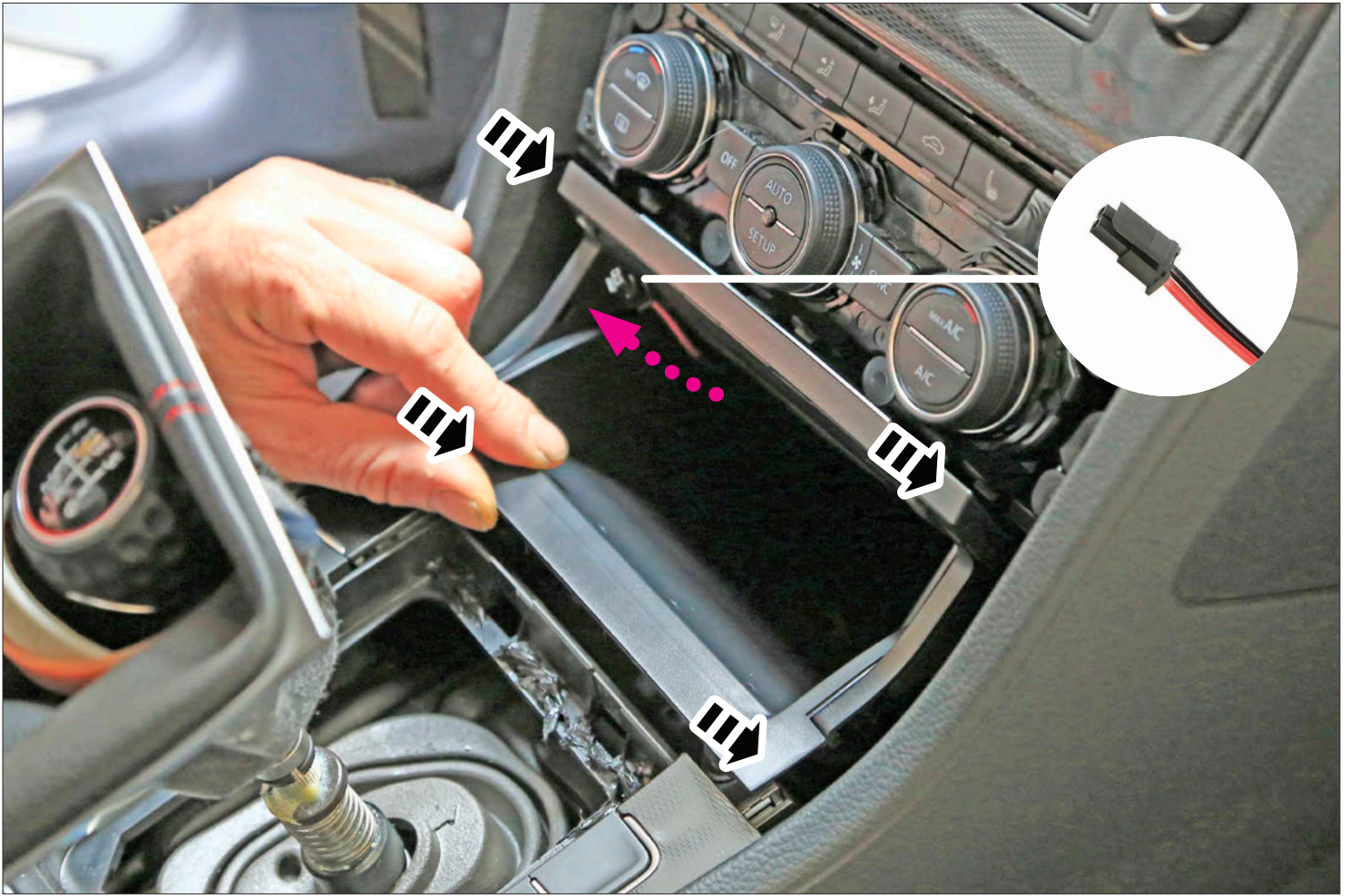

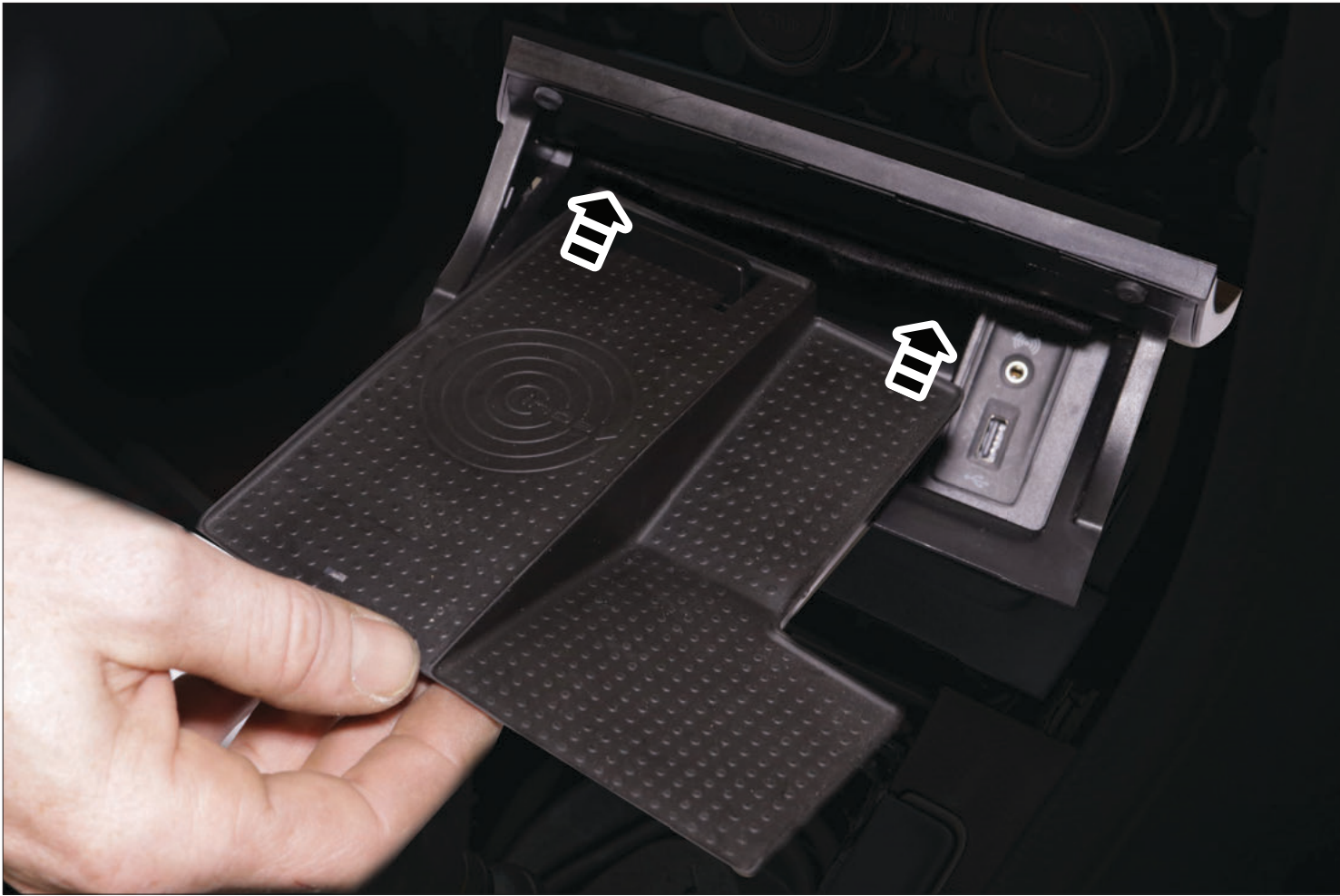



Orange LED
Orange LED



Orange LED blinkt*
Orange LED flashing*



Grüne LED*
Green LED*



*Abhängig vom Smartphone
*Depends on Smartphone

*Erkennung von Fremdkörpern wie Münzen etc. (FOD)
Aus Sicherheitsgründen wird der Ladevorgang gestoppt.

* Detection of foreign objects such as coins etc. (FOD)
The charging process is stopped for safety reasons.

INTEGRATED FOREIGN OBJECT DETECTION (FOD)

WICHTIGE INFORMATION:

Bitte legen Sie keine anderen Gegenstände wie z.B. Münzen, Kreditkarten etc. in die INBAY Ablage. **Insbesondere Smartphones mit angebrachtem Ring Ständer dürfen nicht verwendet werden** - da ansonsten aus Sicherheitsgründen der Ladevorgang durch die integrierte Fremdeilerkennung (FOD) gestoppt wird.

IMPORTANT INFORMATION:

Please don't place any other objects such as coins, credit cards etc. onto the INBAY surface. **Especially smartphones with attached ring stand holder must not be used!** - otherwise the integrated Foreign Object Detection (FOD) will interrupt wireless charging for safety reasons.

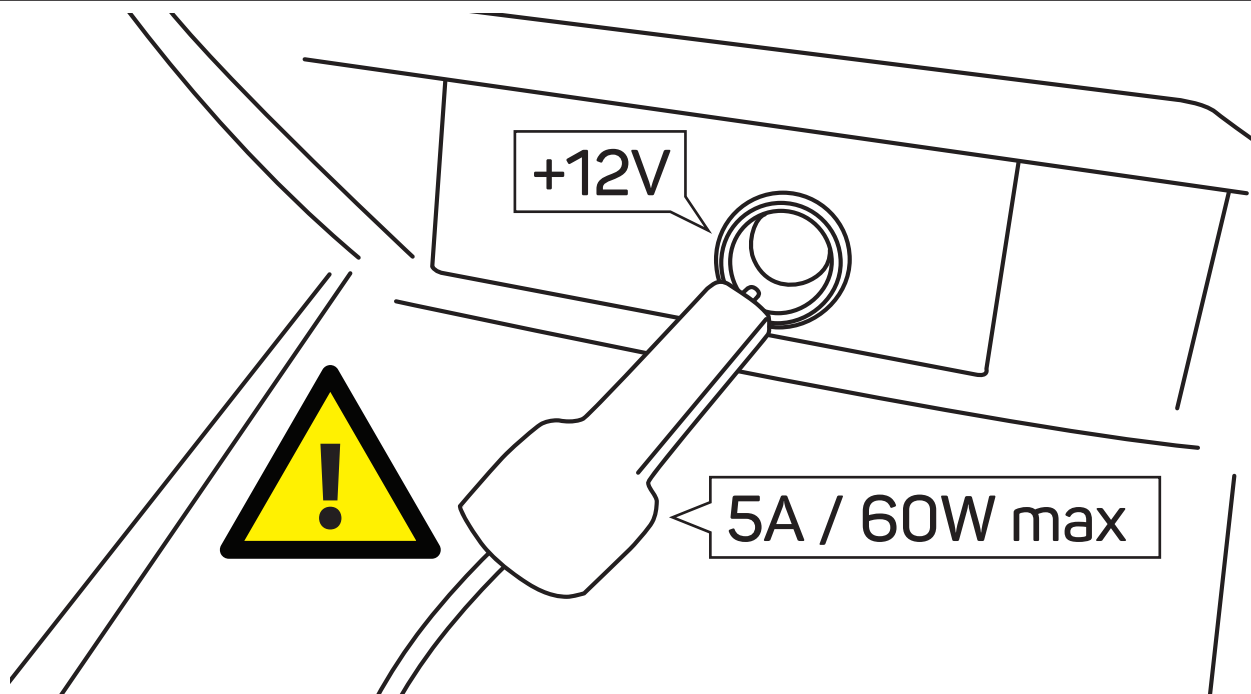
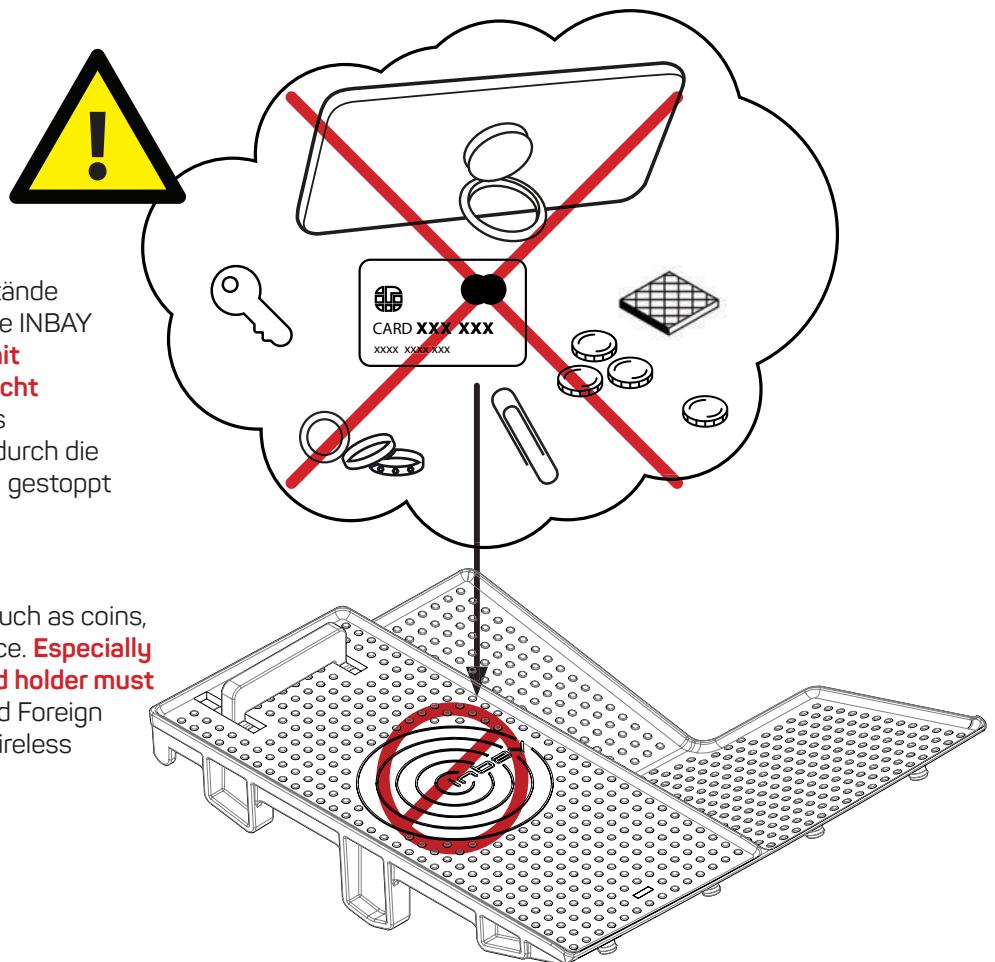

ACHTUNG! Nach der Installation dürfen keine Geräte/Verbraucher mit mehr als **5A / 60W** an der +12V Buchse betrieben werden, da sonst die Gefahr einer Überspannung besteht!

ATTENTION! After installation, devices/consumers with more than **5A / 60W** shall not be operated on the +12V socket. Otherwise a risk of overvoltage can occur!

241320-65-1

Input Voltage	12V (DC)	
Output Voltage	5V	9V
Output Current	1.1A	1.2A
Output Power	5W	10W

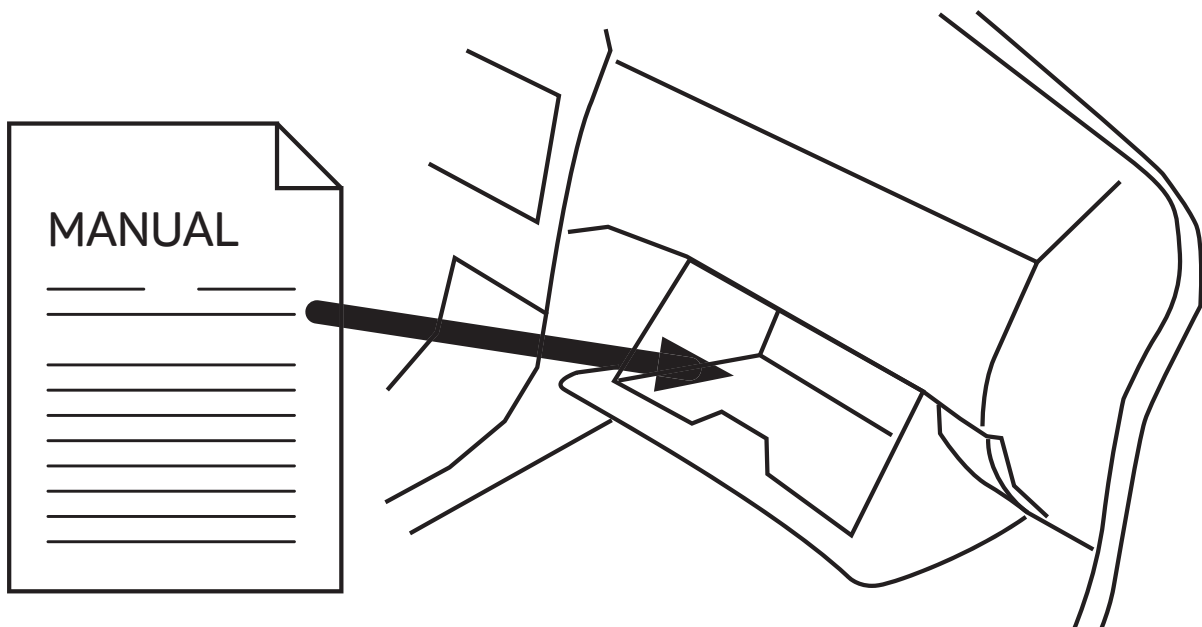
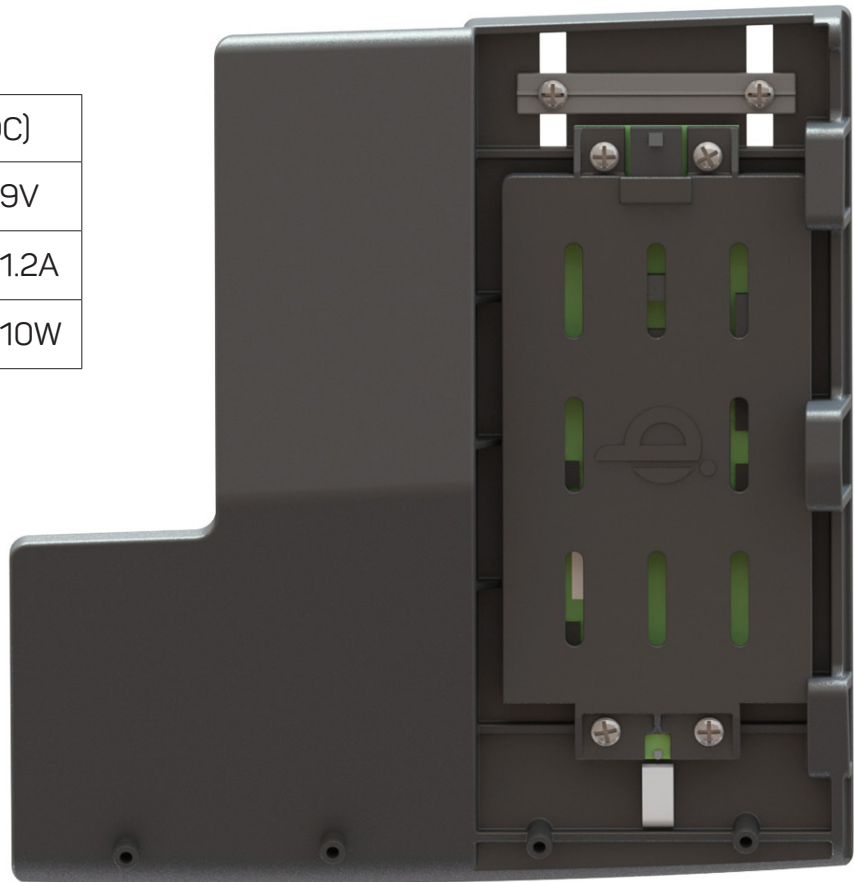

WICHTIG! NACH DER INSTALLATION MUSS DIESE EINBAUANLEITUNG IN DAS HANDSCHUHFACH DES KUNDENFAHRZEUGS GELEGT WERDEN.

IMPORTANT! AFTER INSTALLATION THE MANUAL HAS TO BE PLACED INTO THE DASH BOARD OF THE CUSTOMER'S CAR.





ACHTUNG!
Die gelbe 20A Sicherung muss sich genau an dieser Position befinden !

IMPORTANT!
The yellow 20A fuse has to be exactly in this position !

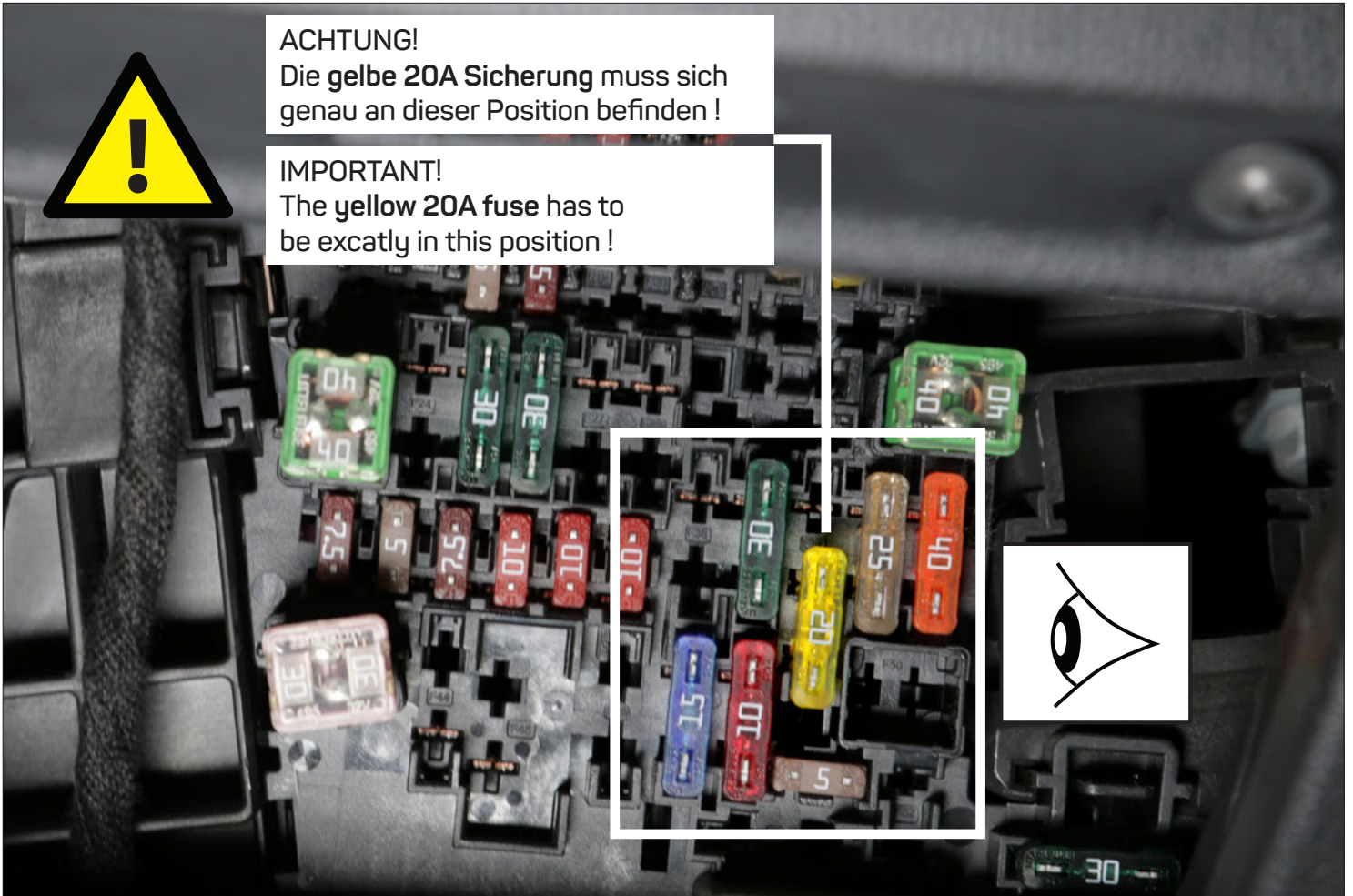

Falls sich die 20A Sicherung an einer anderen Position befinden sollte, stecken Sie diese um !

Switch the place of the 20A fuse if it is at this position !

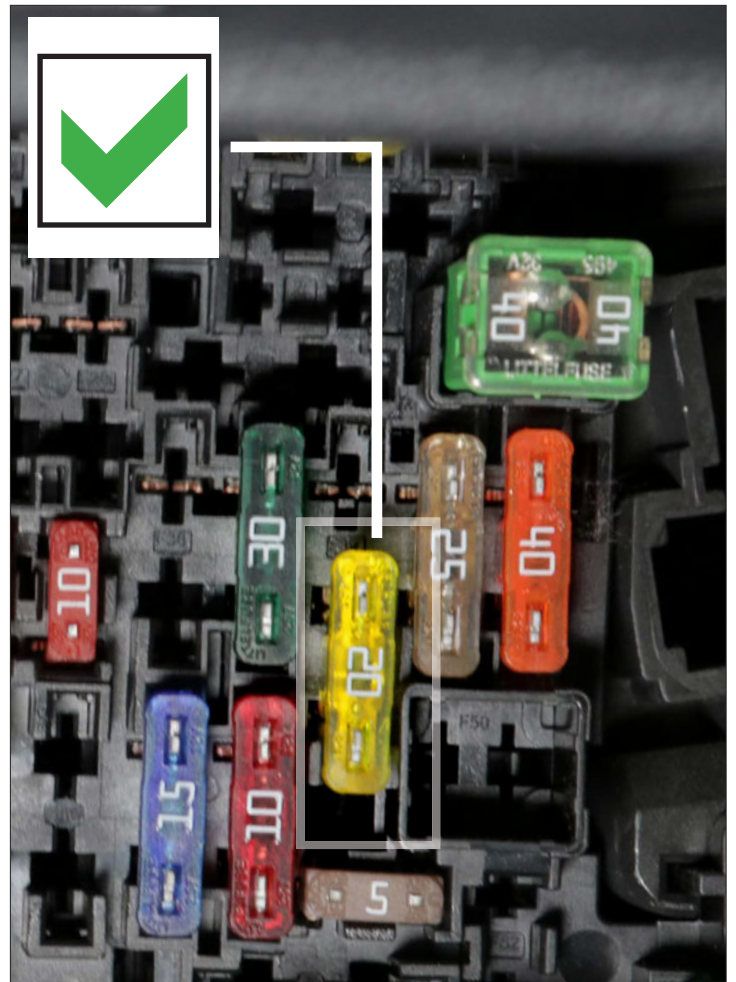

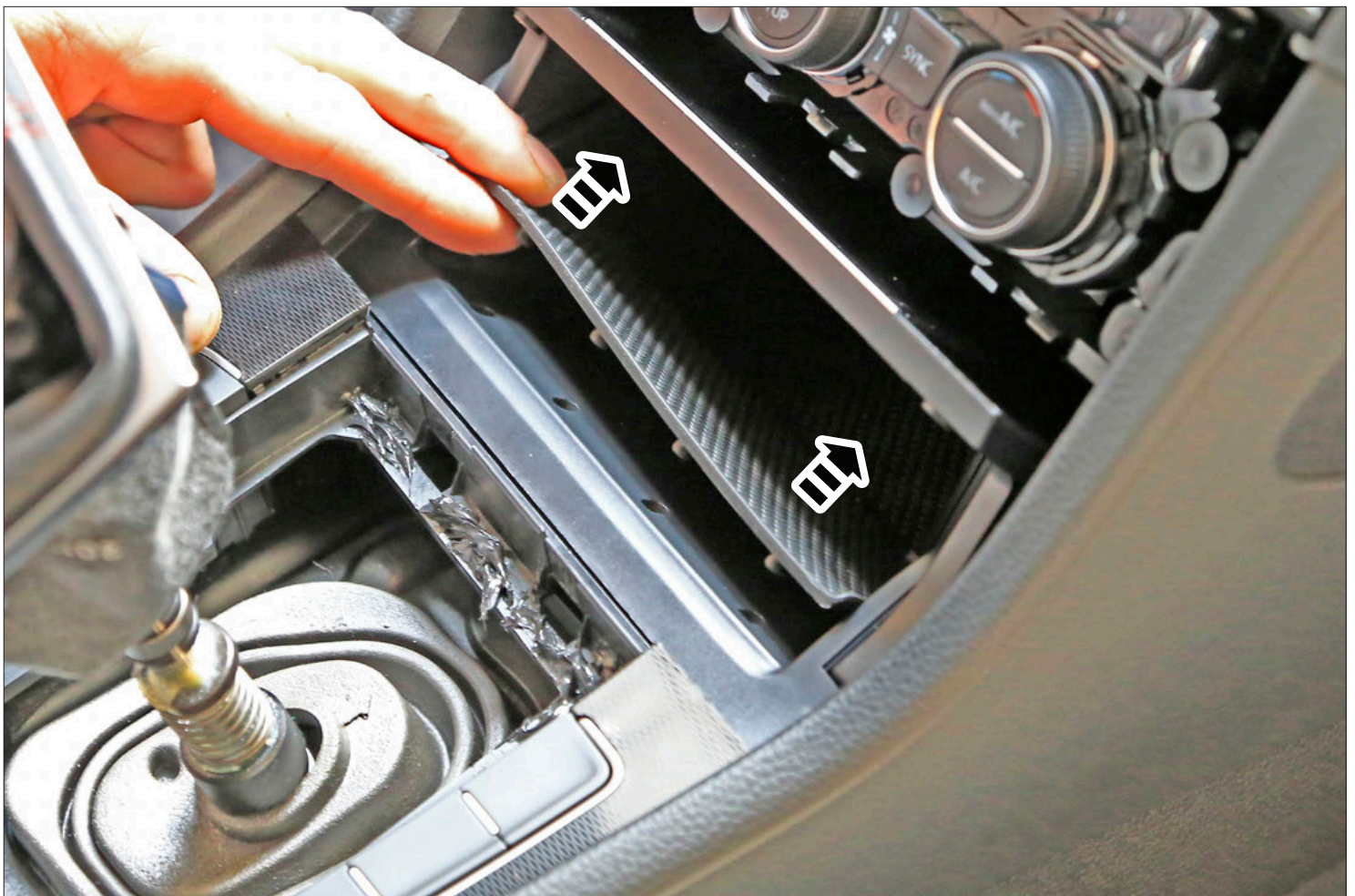

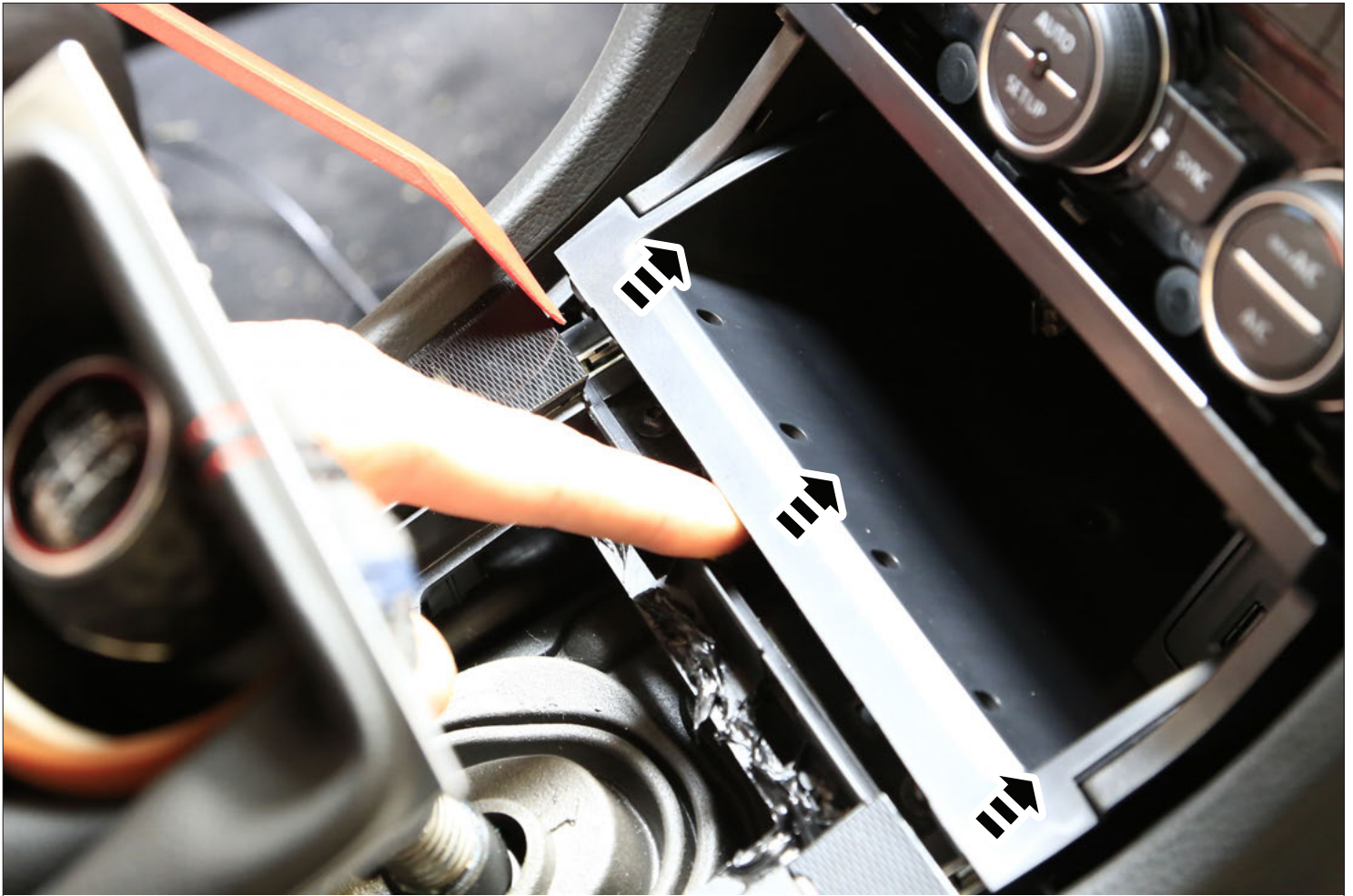

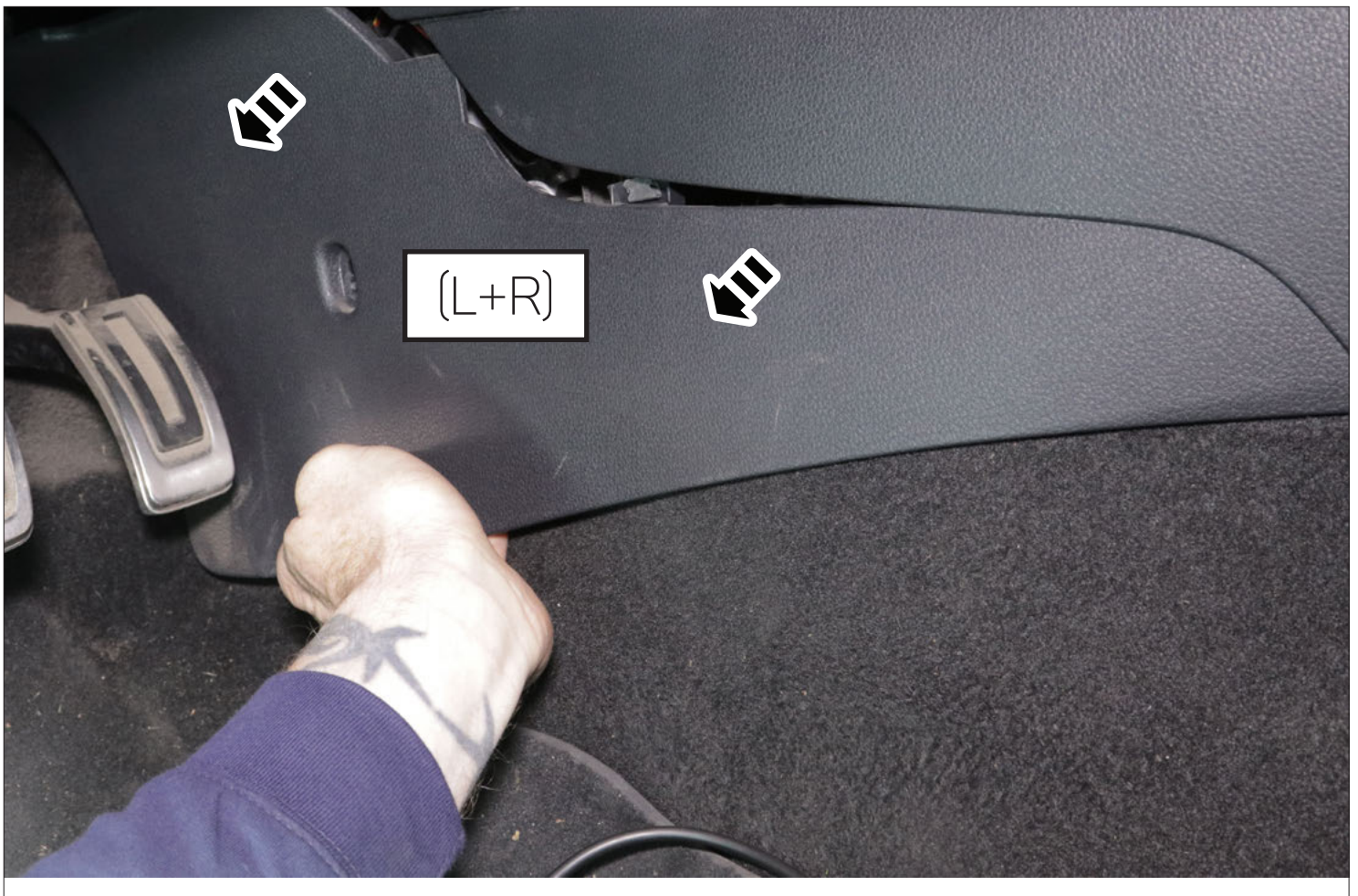

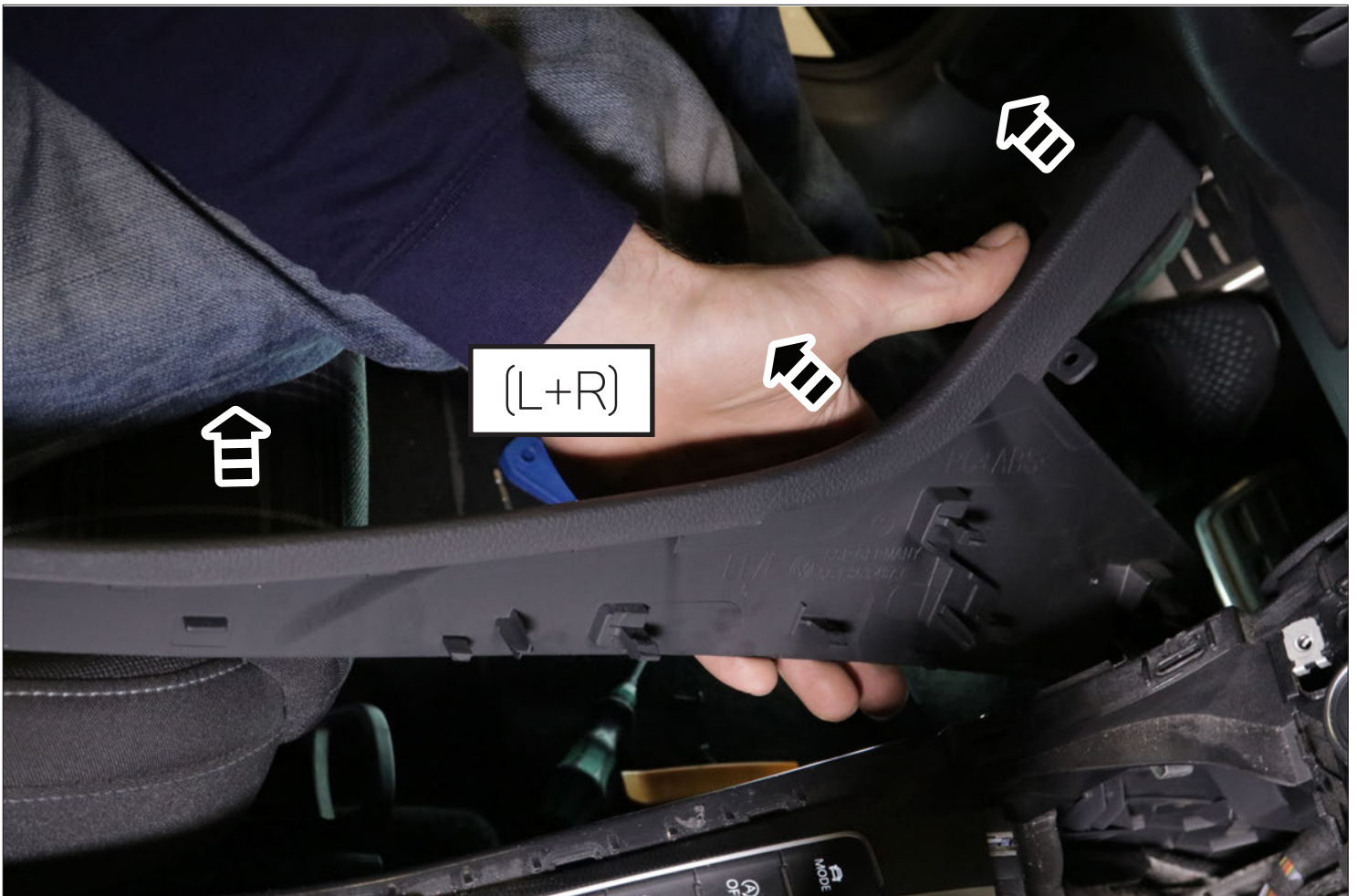







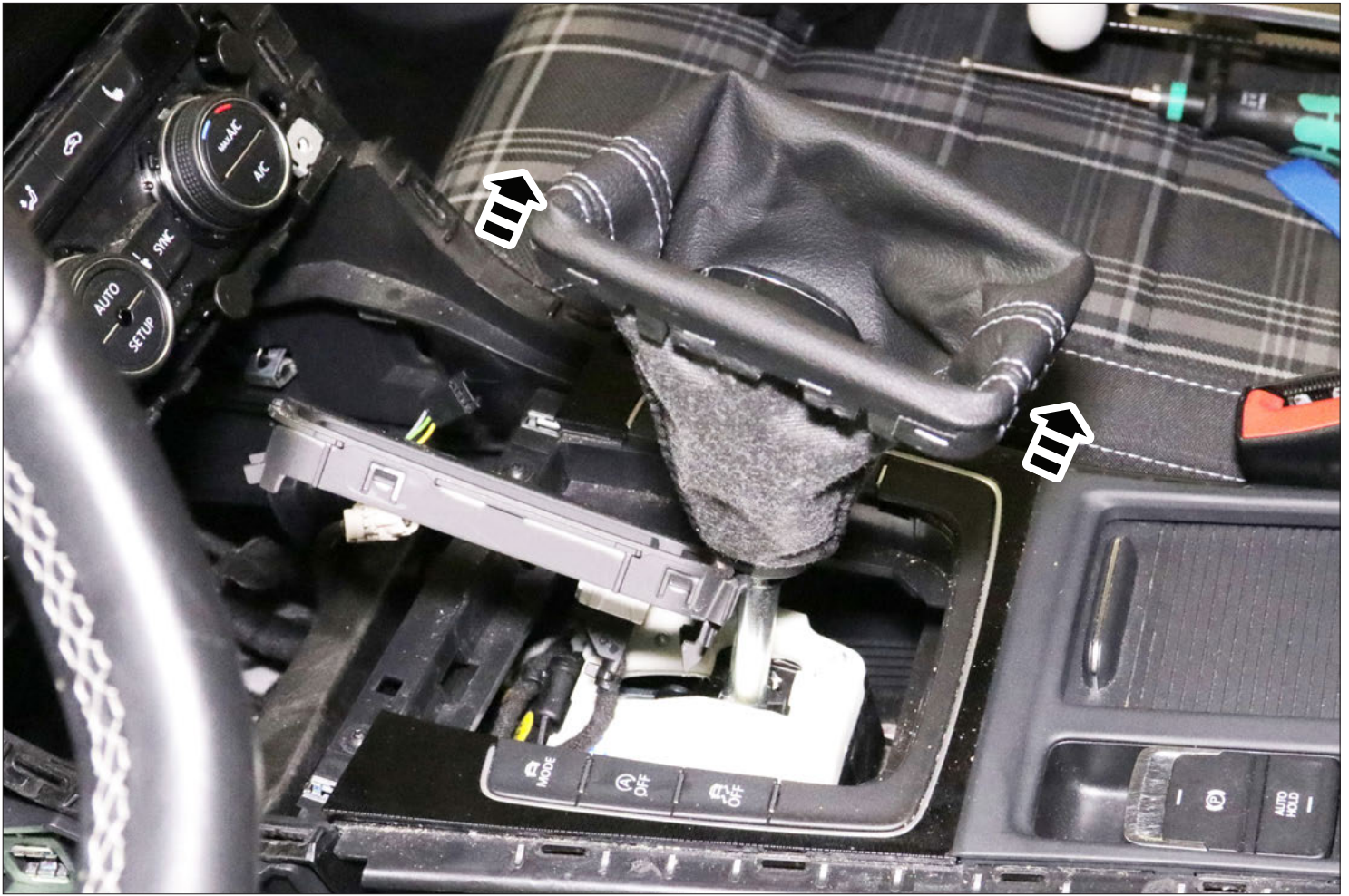

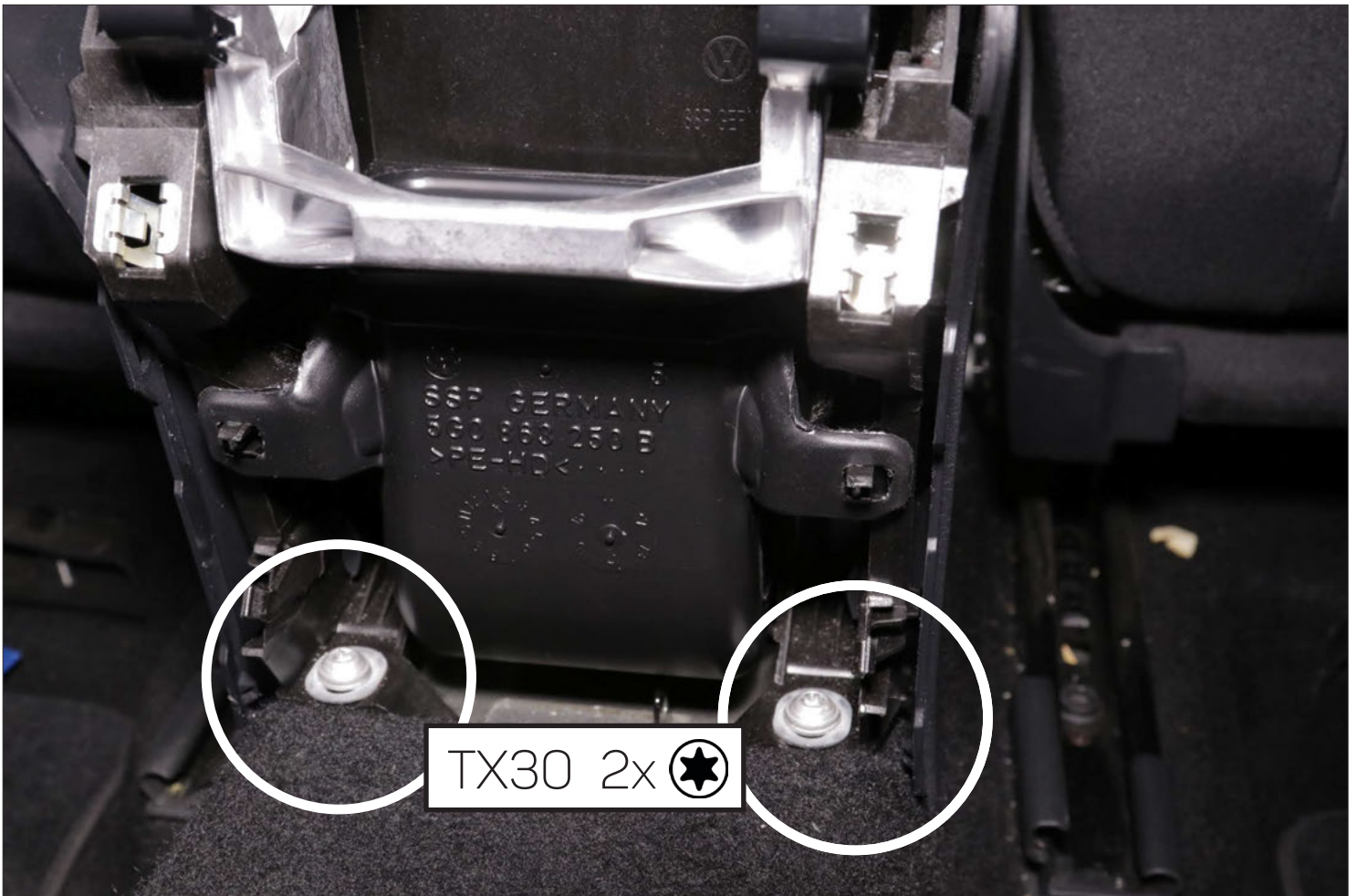

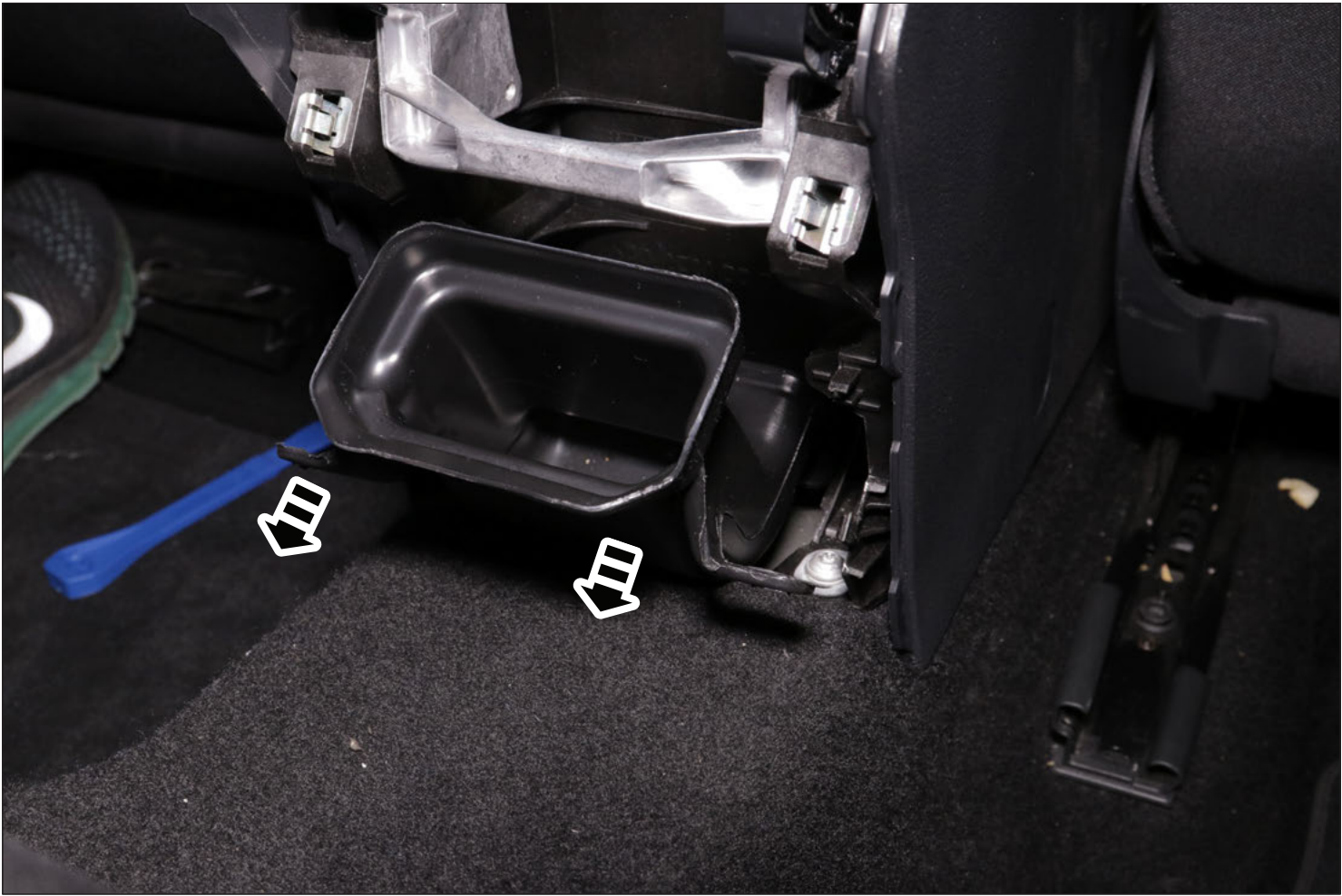

Ziehen Sie die gesamte Konsole nach oben (von hinten) und ziehen Sie den Stecker von der +12V Buchse ab.

Pull the complete panel upwards (from behind) and unplug the plug from the +12V Socket



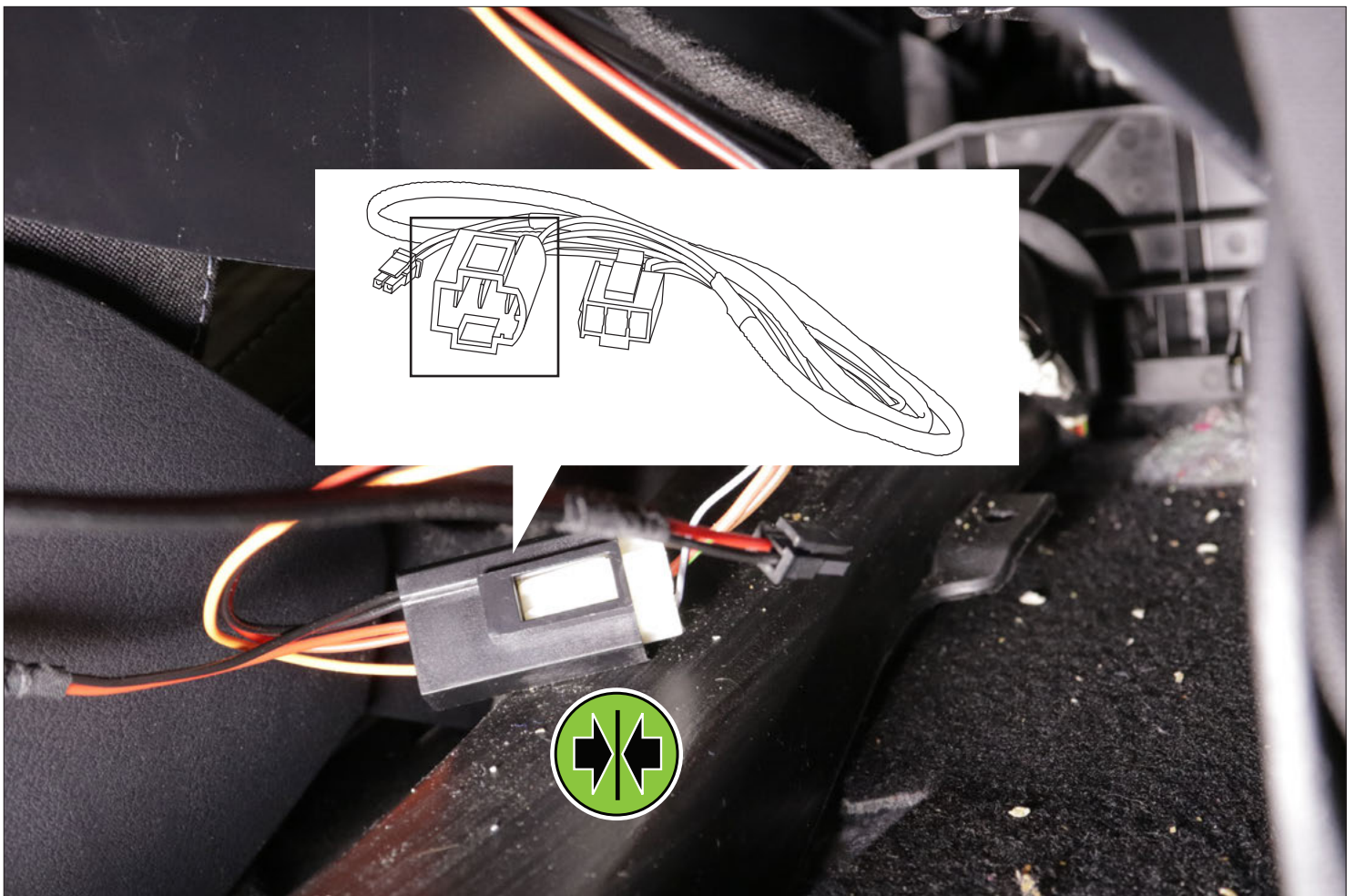
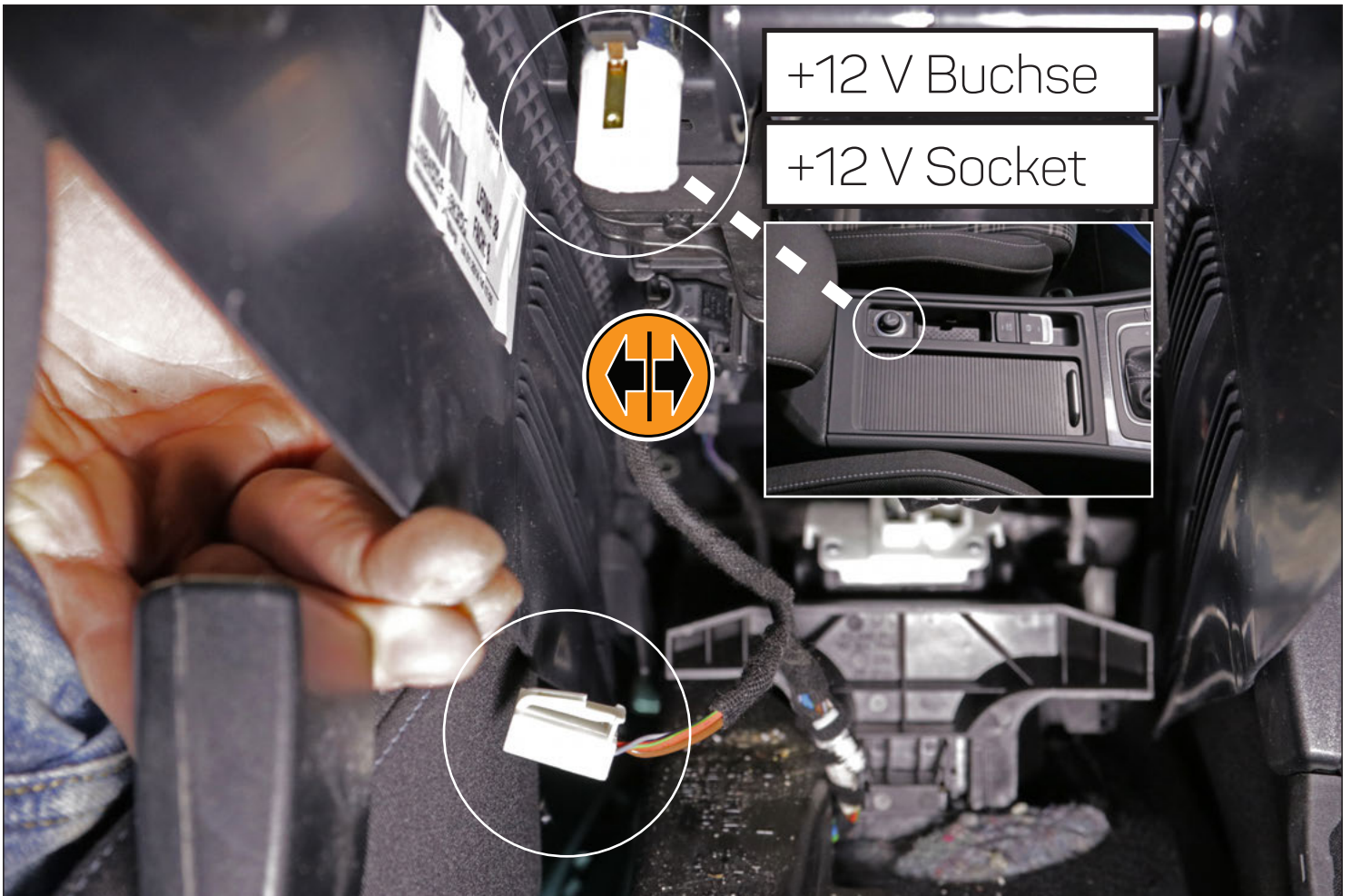

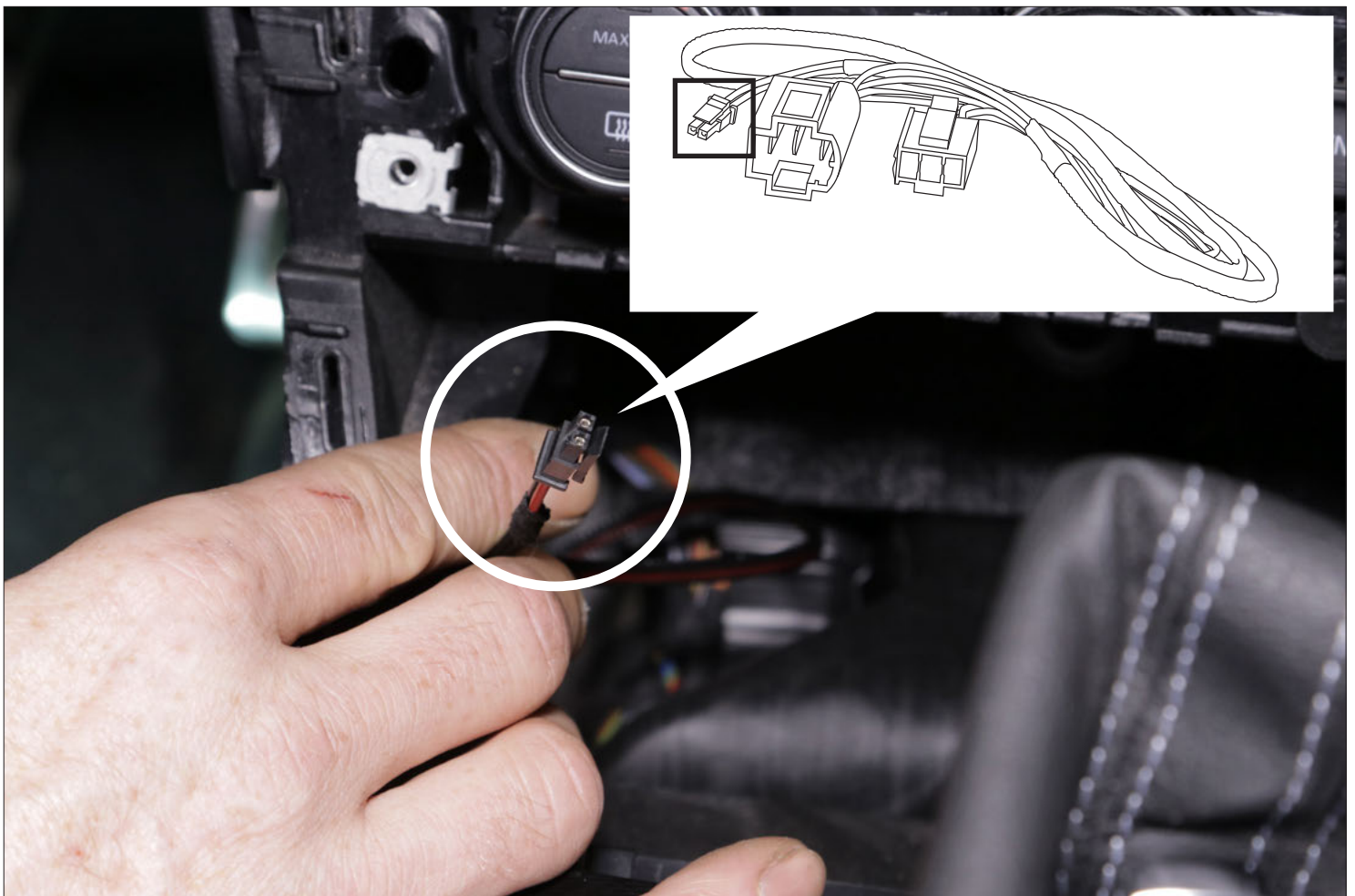
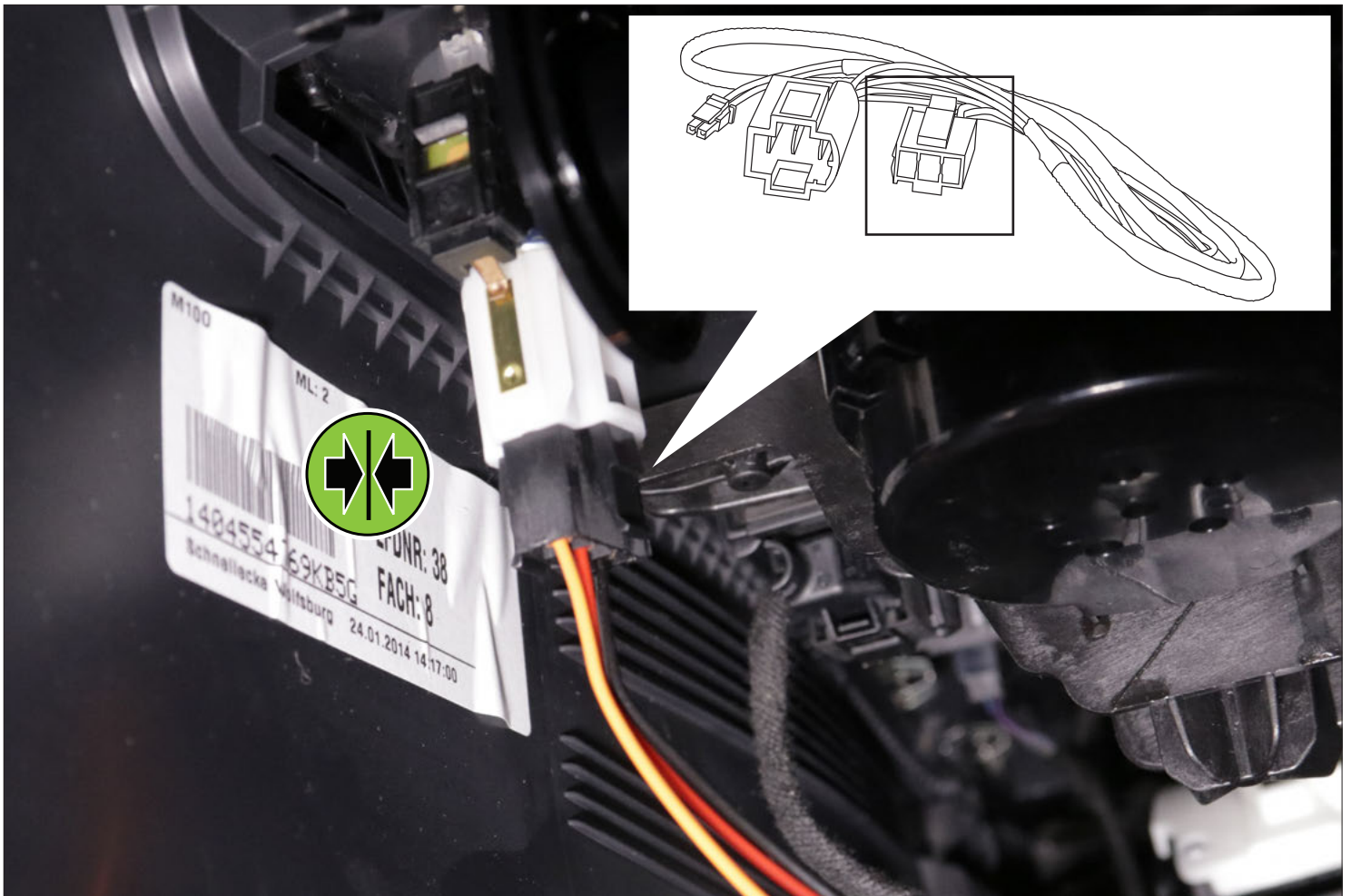

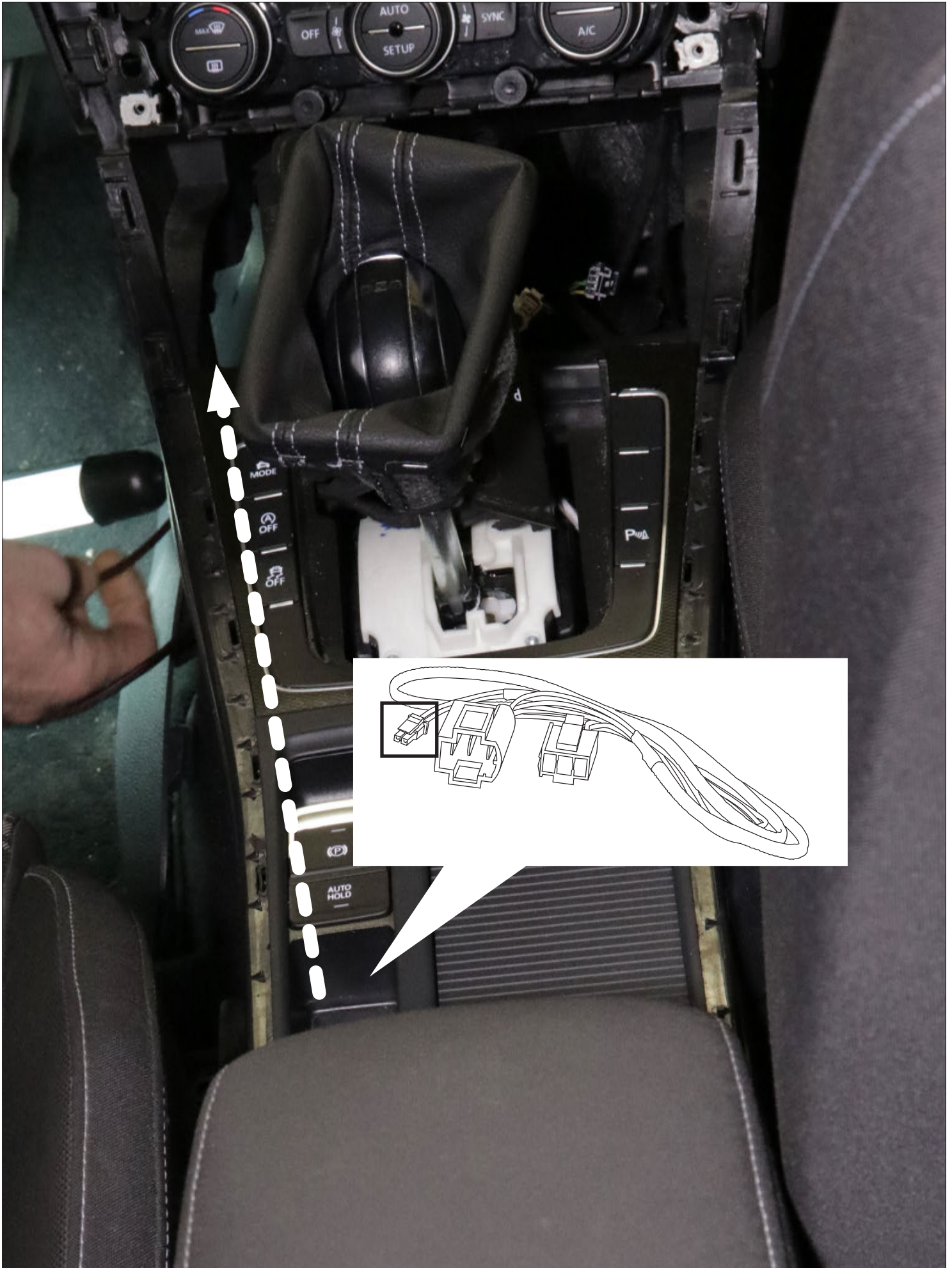



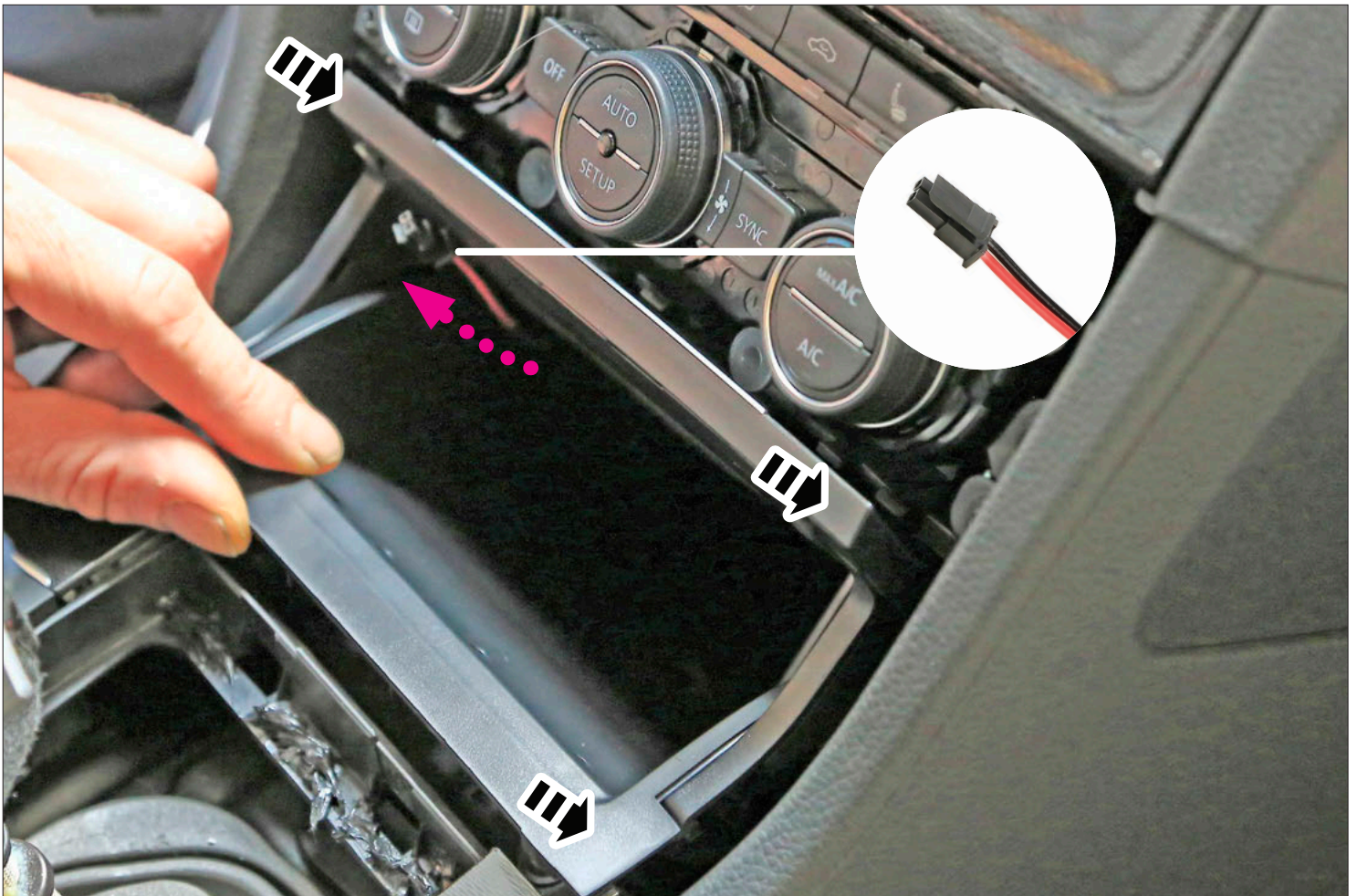
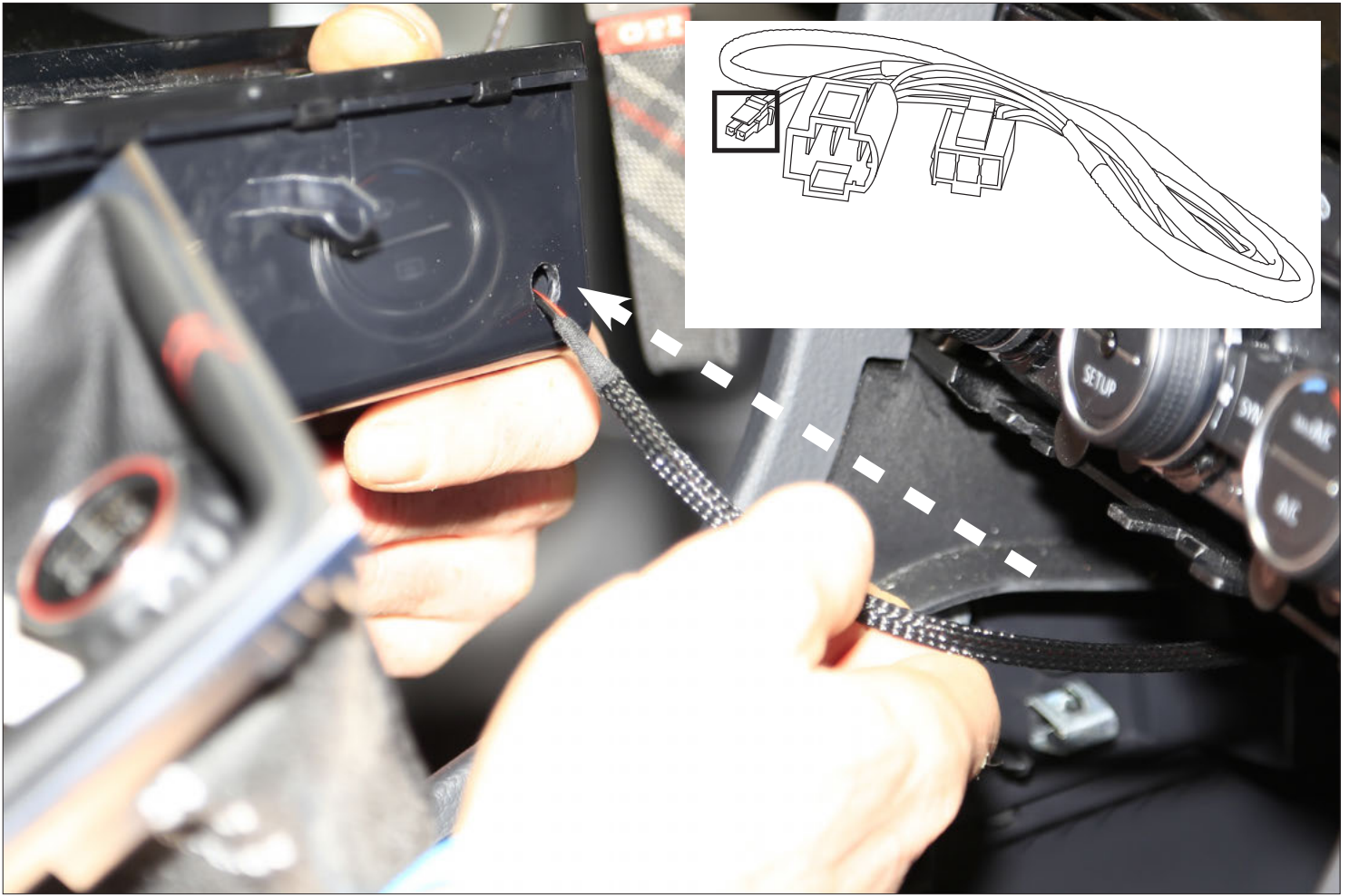

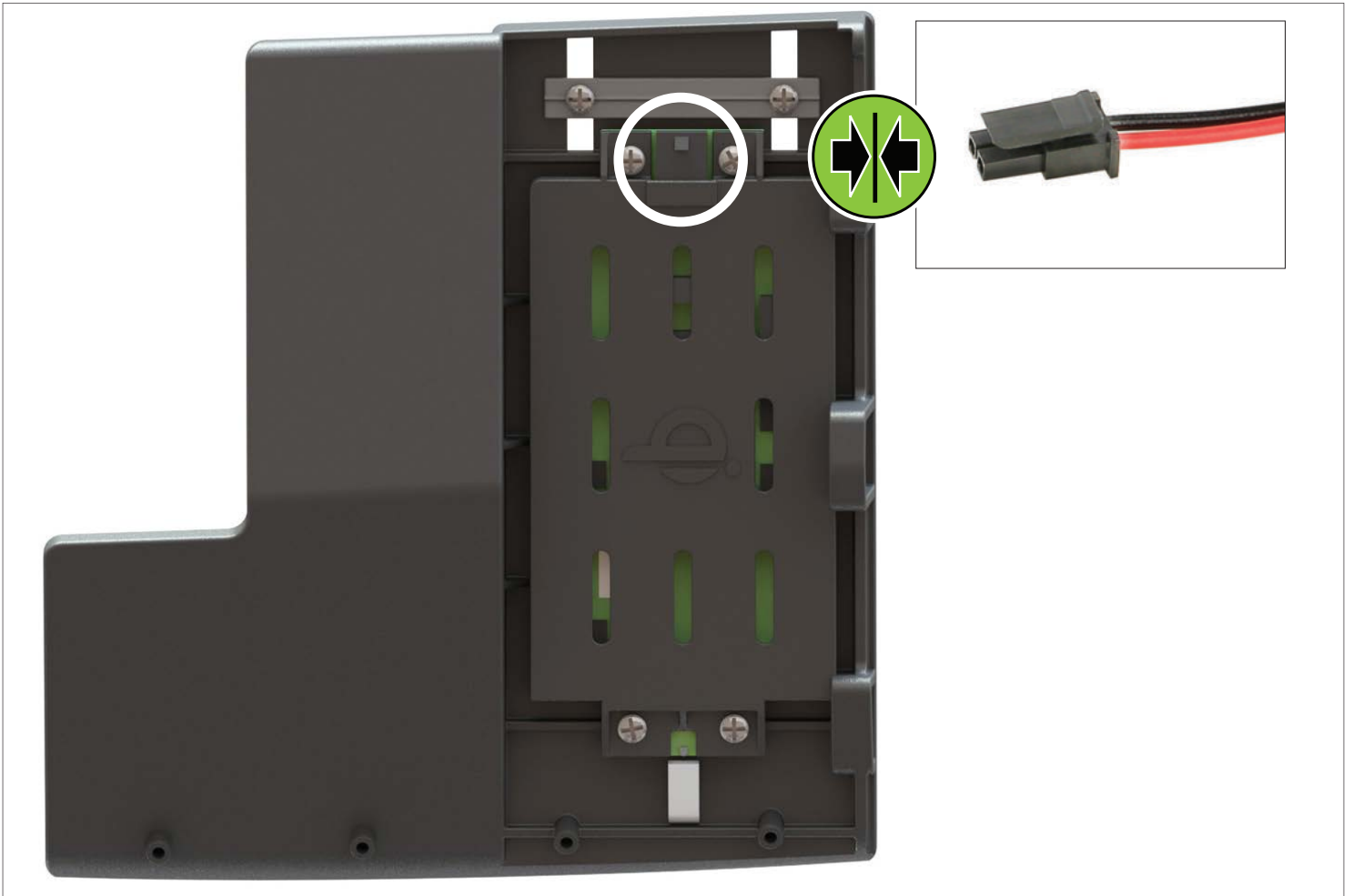



Orange LED
Orange LED



Orange LED blinkt*
Orange LED flashing*



Grüne LED*
Green LED*



*Erkennung von Fremdkörpern wie Münzen etc. (FOD)
Aus Sicherheitsgründen wird der Ladevorgang gestoppt.

* Detection of foreign objects such as coins etc. (FOD)
The charging process is stopped for safety reasons.

*Abhängig vom Smartphone
*Depends on Smartphone

INTEGRATED FOREIGN OBJECT DETECTION (FOD)

WICHTIGE INFORMATION:

Bitte legen Sie keine anderen Gegenstände wie z.B. Münzen, Kreditkarten etc. in die INBAY Ablage. **Insbesondere Smartphones mit angebrachtem Ring Ständer dürfen nicht verwendet werden** - da ansonsten aus Sicherheitsgründen der Ladevorgang durch die integrierte Fremdeilerkennung (FOD) gestoppt wird.

IMPORTANT INFORMATION:

Please don't place any other objects such as coins, credit cards etc. onto the INBAY surface. **Especially smartphones with attached ring stand holder must not be used!** - otherwise the integrated Foreign Object Detection (FOD) will interrupt wireless charging for safety reasons.

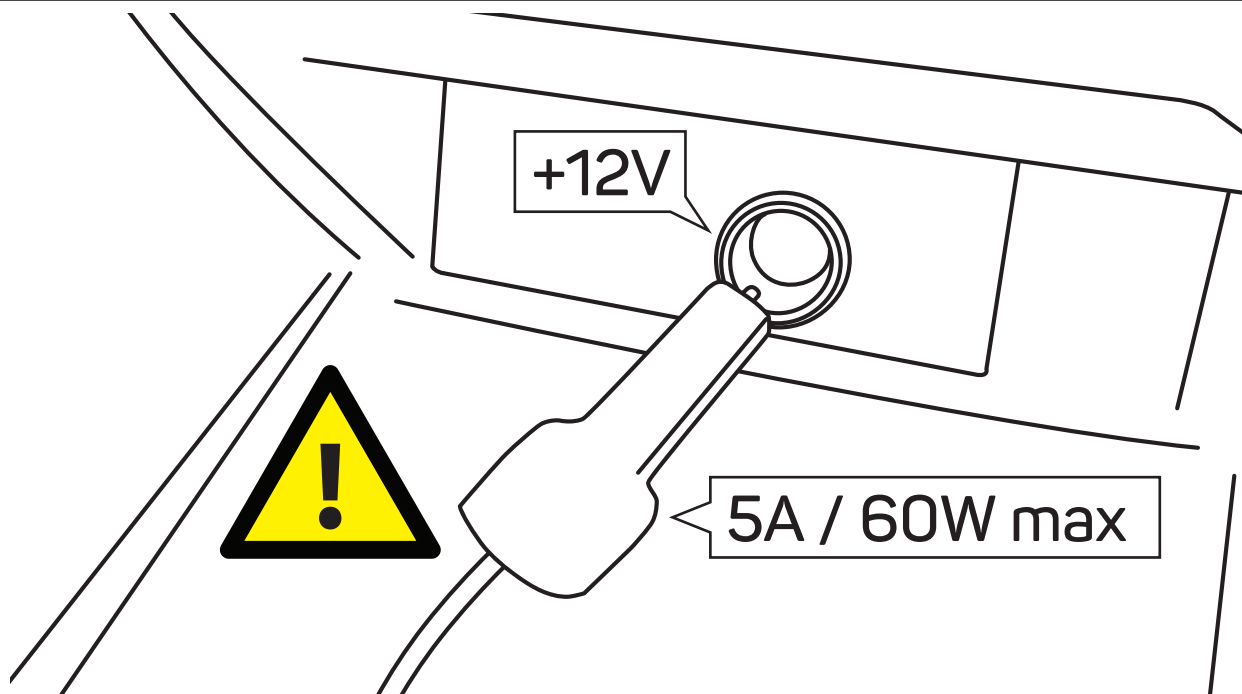
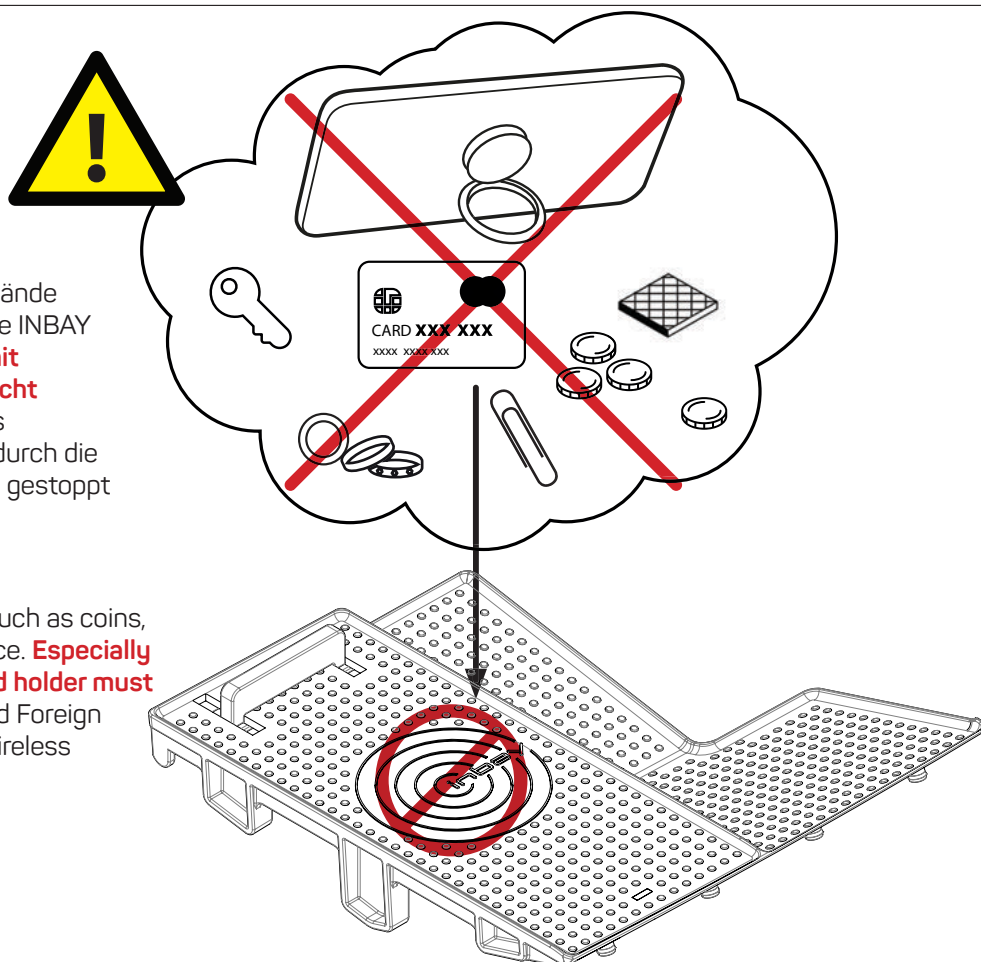

ACHTUNG! Nach der Installation dürfen keine Geräte/Verbraucher mit mehr als **5A / 60W** an der +12V Buchse betrieben werden, da sonst die Gefahr einer Überspannung besteht!

ATTENTION! After installation, devices/consumers with more than **5A / 60W** shall not be operated on the +12V socket. Otherwise a risk of overvoltage can occur!

241320-65-1

Input Voltage	12V (DC)	
Output Voltage	5V	9V
Output Current	1.1A	1.2A
Output Power	5W	10W

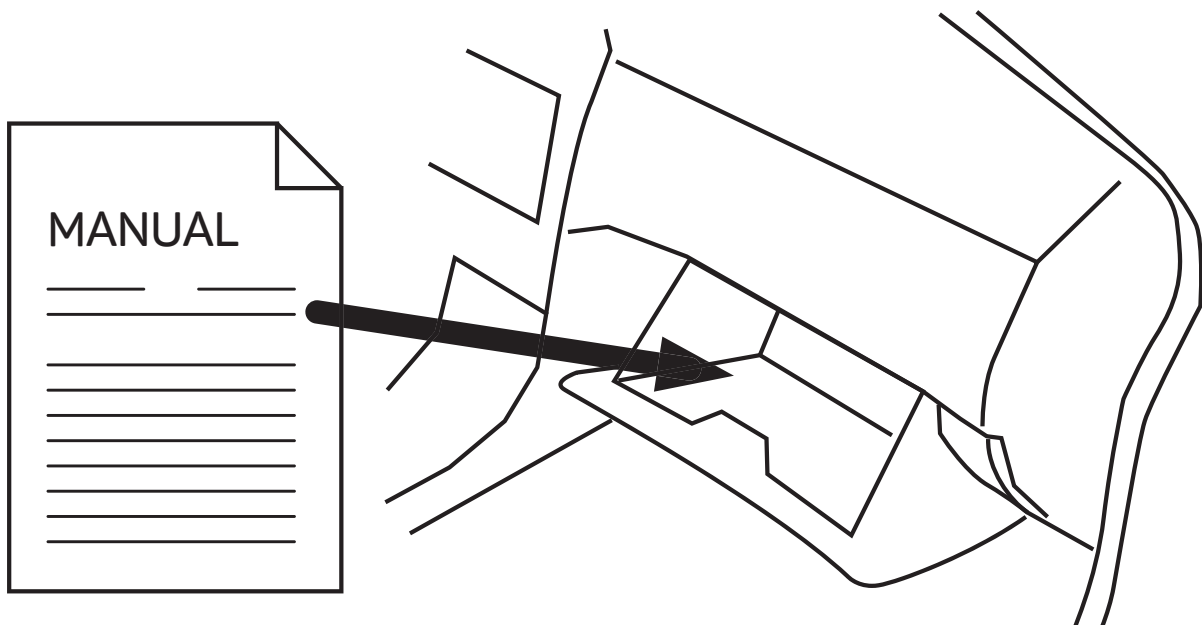
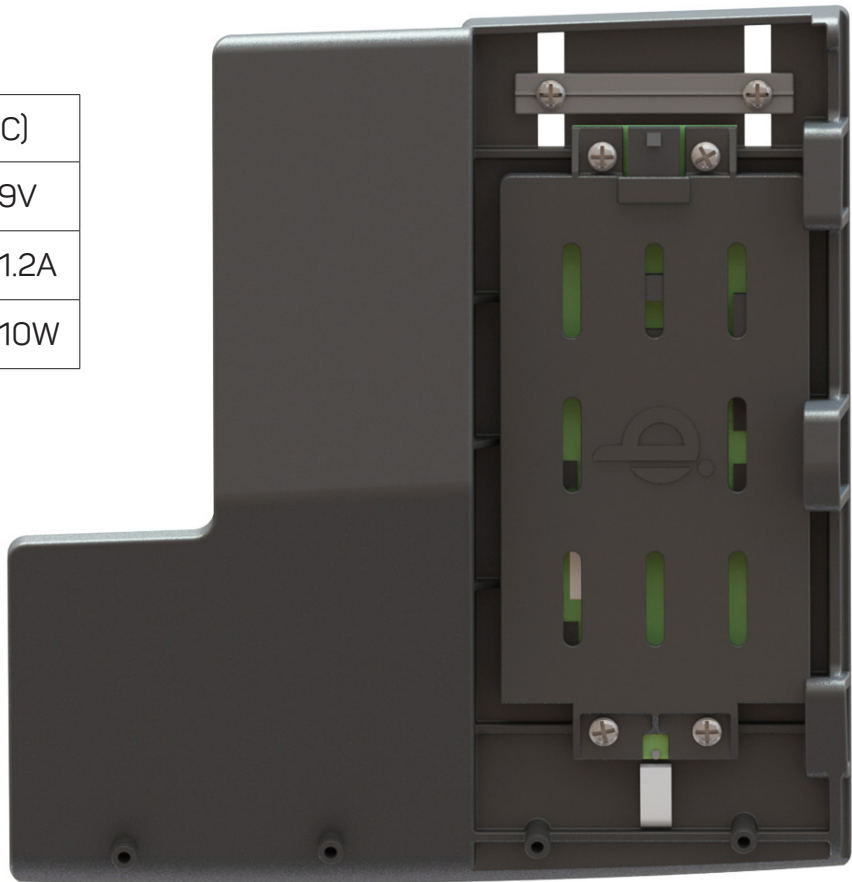

WICHTIG! NACH DER INSTALLATION MUSS DIESE EINBAUANLEITUNG IN DAS HANDSCHUHFACH DES KUNDENFAHRZEUGS GELEGT WERDEN.

IMPORTANT! AFTER INSTALLATION THE MANUAL HAS TO BE PLACED INTO THE DASH BOARD OF THE CUSTOMER'S CAR.