



STANLEY®

**STANLEY TOOLS
2023**

THE MEASURE OF A PRO™
[www.STANLEYWORKS](http://www.STANLEYWORKS.SE).SE | NO
DK | FI



A STORY BEHIND EVERY TOOL

Solid, tried and true. For those willing to get their hands dirty to raise the bar. Because the measure of a pro is the work they leave behind. Their legacy is every project completed until they break ground and build what's next. Our legacy? That's simple. It's on the hip and in the hand of every Pro since 1843.

THE MEASURE OF A PRO™

CONTENTS

11

Knives

- 17** Retractable blade Knives
- 25** Safety Knives
- 30** Fixed blade Knives
- 33** Spare blades
- 38** Snap-off blade Knives
- 44** Replacement blade Snap-off
- 47** Hobby/Sports Knives
- 50** Replacement blades hobby/sport Knives
- 51** Glass scrapers
- 52** Multi-tool
- 53** Scissors
- 54** Insulating Knives

55

Measuring Tool

- 61** Short Tape Measures with thumb lock
- 68** Short Tape Measures without thumb lock
- 69** Folding Rules
- 72** Long tapes
- 75** Measuring wheels
- 78** Marking out tools
- 80** Chalk line reels
- 83** Markers and Pencils

85

Levels

- 87** Levels

97

Lasers and detectors

- 100** Distance measuring
- 107** 360° lasers
- 110** Cross lasers
- 115** Point/spot lasers
- 116** Rotary Lasers
- 121** Laser Accessories
- 121** Laser Detectors
- 127** Stud Sensors
- 130** Inspection Cameras / Thermometers
- 132** Multi Meters

135

Hammers

- 139** Claw Hammers
- 141** Blacksmith Hammers
- 142** Locksmith Hammers
- 144** Club Hammers
- 145** Construction Hammers
- 148** Speciality Hammers
- 150** Rubber/Compo-Cast® Hammers

151

Demolition material

- 153** Crowbars

157

Clamps and vices

- 163** Clamps and Vices

169

Sawing

- 171** Wood saws
- 175** Miter boxes
- 177** Specific Saws
- 183** Metal Saws / Hacksaws
- 186** Spare Blades Hacksaws
- 187** Saw Sets
- 188** Tree/Pruning Saws
- 189** Spare Blades Tree/Pruning Saws

191

Chisels and punches

- 194** Chisels Sweetheart and Bailey
- 194** Chisels Bailey
- 196** Chisels FATMAX®
- 198** Chisels Dynagrip™
- 200** Chisels Basic
- 202** Cold chisels FATMAX®
- 206** Punches & Center Points

CONTENTS

209

Planes

- 211** Bailey® Planes
- 213** Handyman Planes
- 214** SB Bench Planes
- 215** Combination Planes / Spare blades
- 216** Block Planers
- 218** Specific Planers
- 219** Planer Accessories

221

Files, rasps and SURFORM®

- 222** Files
- 225** Rasps
- 227** Plane Surform® Metal
- 229** Plane Surform® Plastic
- 230** Surform® Spare Blades

233

Screwdrivers, bits & Hex Keys

- 235** FATMAX® Screwdrivers
- 245** FATMAX® Bolster Screwdrivers
- 247** FATMAX® VDE Screwdrivers
- 251** Cushion Grip Screwdrivers
- 256** Screwdrivers Essential
- 258** Speciality Screwdrivers
- 259** Precision Screwdrivers
- 263** Bits Screwdriver
- 264** Ratchet Screwdrivers
- 266** Screwdrivers & Bits sets, Hand Drills
- 272** T-Handles, P-Handles, Hex Keys

275

Key Tools

- 278** Reversible Ratcheting Wrench Sets
- 279** Combination Wrenches
- 283** Adjustable Wrenches
- 285** Ratchets
- 288** Ratchet Sets 1/2", 1/4" & 3/8"
- 289** Socket Sets 1/4"
- 290** Socket Sets 3/8" & 1/2"
- 292** Socket Sets Mixed
- 294** 1/2" MAXIDRIVE Sockets
- 295** 1/2" Accessories
- 296** 3/8" MAXIDRIVE Sockets
- 297** 3/8" Accessories
- 298** MAXIDRIVE Sockets 1/4"
- 300** 1/4" Accessories
- 301** PRO-STACK Socket Set Foam Inlays
- 303** FATMAX® PRO-STACK® Socket Kits
- 305** Transmodule System
- 309** Automotive Tools

309

Pliers and Scissors

- 311** FATMAX® Pliers
- 321** Dynagrip Pliers
- 323** VDE Pliers
- 325** Pliers Sets
- 328** Locking Pliers
- 327** FATMAX® Locking Pliers
- 328** Speciality Pliers
- 331** Aviation Snips
- 333** Bolt Cutters

335

Fastening Tools

- 343** Staple Guns & Hammer Tackers
- 353** Staples
- 352** Riveters
- 354** Glue Guns

CONTENTS

360

Plumbing Tools

- 360** Tools for Plumbing

364

Drywall Tools

- 366** Drywall Tools

374

Work Lights

- 375** Flash Lights
- 376** Flash Lights

378

Storage Solutions

- 381** Rolling Workshops
- 384** Mobile Job Chests
- 388** Toolboxes
- 396** Technicians Cases
- 398** Tool Bags
- 407** Tool Belts
- 410** Knee Pads
- 413** FATMAX® PRO-STACK
- 418** FATMAX® PRO-STACK® Kits
- 421** Organizers

428

Workshop Solutions

- 429** Metal Cabinets Ready to Assemble
- 429** Tool Cabinets
- 430** Trackwall® Hanging System
- 435** Workbenches & Sawhorses



61



171



237



244



244



247



413

OVERVIEW OF DIDACTICAL PAGES

The didactic pages guide you in choosing the right tool according to your own preferences and needs. These pages will help you learn about unique features that help you deliver outstanding results.

Knives  PAGE 13 - 16, 22 - 23, 38	MEASURING TOOLS  PAGE 57 - 60, 71, 77	LASERS AND DETECTORS  PAGE 98 - 99, 105 - 106	HAMMERS  PAGE 137
DEMOLITION TOOLS  PAGE 152	CLAMPS  PAGE 159 - 162	SAWS  PAGE 170, 182	CHISELS  PAGE 193
PLANERS  PAGE 210	SURFORM®  PAGE 226	SCREWDRIVERS  PAGE 234, 246	PLIERS  PAGE 313
MOUNTING TOOLS  PAGE 340 - 342, 351 - 352	STORAGE SYSTEMS  PAGE 379, 412		

A WORD OF EXPLANATION ABOUT THE PRODUCT INFORMATION

Below is an example of a FATMAX® Hero product with the most important features highlighted, along with all product variants and prices in a clear table.

FATMAX® SNAP-OFF KNIFE QUICK SNAP 18 MM

STANLEY
FATMAX

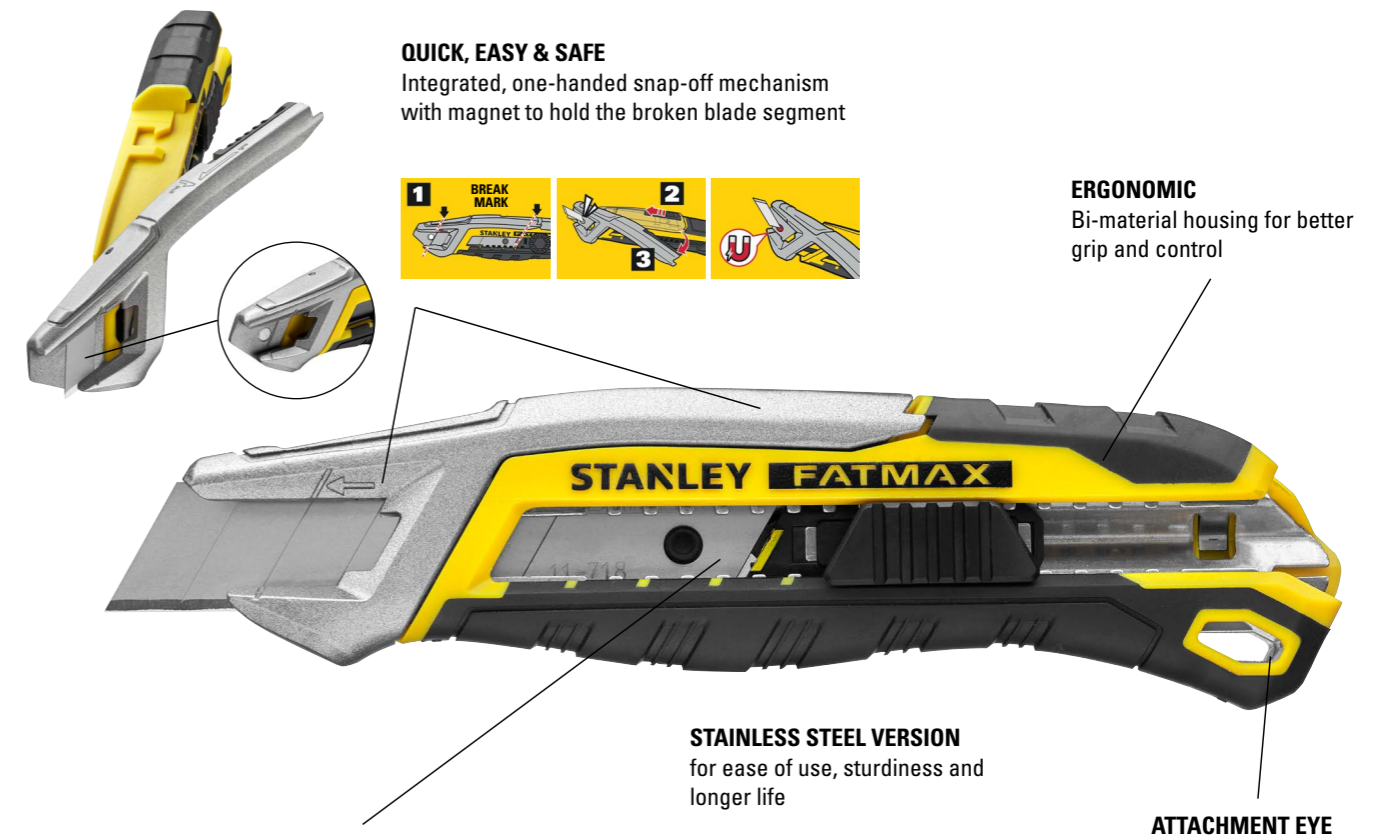

CODE	DESCRIPTION				PRICE
FMHT10594-0	Fatmax Snap-Off Knife Quick Snap 18 mm - Length: 165 mm	X	6		18.40

FMHT 10594-0

Use this code when ordering

Product description	Packaging type	Packing unit	EAN code	Gross retail price excl. VAT
	"X" = product on card "-." = product in bulk	This number indicates the number of products in an outer box. All Knives/replacement Knives, tape measures, folding rules, clawhammers and products in display can be purchased per full package.		

Alternative Codes:

XTHT1-51124

XTHT = FATMAX® Pro Hand Tools
FMHT = FATMAX® Hand Tools
STHT = STANLEY Hand Tools
STST = STANLEY Storage

OUR STORY

STANLEY® has set the precedent for quality tools and engineered solutions for professionals around the globe for more than 175 years. With a legacy of reliability, **STANLEY** is the No. 1 tapes manufacturer in the world and continues to drive the industry forward with innovations including the **STANLEY® FATMAX®** product line as well as hand tools, power tools, storage and accessories that get the job done.

We're proud of our reputation for excellence and are dedicated to continually testing, designing, and improving our products to ensure quality and maximum function. Maintaining our standing as the world's best at what we do is vital to us and what you expect from a name like **STANLEY**.

For more than 175 years our innovative products have helped build, repair and protect our world. Today that legacy continues. Explore our history by using the interactive timeline below.



THE MEASURE OF A PRO™



KNIVES

Rely on STANLEY® for utility knives, pocket knives, replacement blades, Snap-off knives, safety knives, and specialty knives for a variety of cutting jobs from floor to roof and wherever razor-sharp performance is required.





KNIVES

Rely on STANLEY® for utility knives, pocket knives, replacement blades, snap-off knives, safety knives, and specialty knives for a variety of cutting jobs from floor to roof and wherever razor-sharp performance is required.

KNIFE INFORMATION

THE BEST KNIFE MEETS YOUR NEEDS

We now offer the most comprehensive range of fixed, retractable, and snap-off knives and blades, with innovative features that meet the needs of professional contractors and craftsmen.



FIXED BLADE KNIVES

Fits all STANLEY replaceable blades. These are intended for the toughest applications. Although it is a fixed leaf, the majority of STANLEY knives include a quick blade change system.



SAFETY KNIVES

A range of safe cutting solutions. Safety above all!



SNAP-OFF KNIVES 25, 18 & 9 mm

Ideal in situations where residues stick to the blade. The snap-off blade provides consistently sharp edges, but is also strong and thick enough to withstand heavy pressure without breaking the blade.



CRAFT, SPORTS, POCKET KNIVES

A fantastic range. Handy pocket, hobby and sports knives, ideal for many types of tasks.

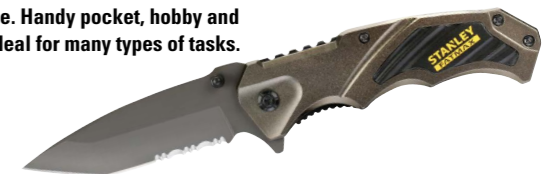

RETRACTABLE UTILITY KNIVES

Suitable for most replaceable blades. These offer the same performance as the fixed blade models and the blade retracts safely into the handle when the blade is not in use.



BLADES		
STANLEY	STANLEY FATMAX	STANLEY CARBIDE™ BLADE
General applications	75% sharper, 2x longer life	10x more durable

RETRACTABLE UTILITY KNIVES OVERVIEW

TYPE	IMAGE	Metal housing	Bimaterial grip	Integrated magazine for spare blades	Quick blade change system	Blade locking system		
0-10-789 FATMAX® PRO		•	•	•	•	•	RETRACTABLE BLADE KNIVES	
0-10-819 FATMAX® PRO		•		•	•	•		
2-10-122 TITAN		•		•	•	•		
0-10-788 INSTANT CHANGE		•	•	•	•			
0-10-778 FATMAX®		•	•	•	•			
0-10-237 AUTOLOAD		•	•	•	•			
STHT10432-0 COMPACT		•	•		•	•		
STHT10479-0 SOFTGRIP		•	•	•	•	•		
STHT10430-0 EXTENSION BLADE		•	•	•	•	•		
1-10-099 99 E		•		•		•		
0-10-088 ABS				•	•	•		
0-10-810 QUICKSLIDE		•			•	•		
XTHT0-10502 DUO EXTENDABLE FOLDING KNIFE		•	•		•			FOLDING RETRACTABLE BLADE KNIVES
0-10-825 FOLDABLE EXTENSION BLADE		•	•	•	•			
FMHT0-10827 FIXED FOLDING KNIFE		•	•	•	•			
STHT10424-0 FIXED FOLDING KNIFE		•			•			

FIXED BLADE UTILITY KNIVES OVERVIEW

TYPE	IMAGE	Metal housing	Bimaterial grip	Integrated magazine for spare blades	Quick blade change system	Blade locking system	
0-10-818 FATMAX® PRO		•		•	•	•	FIXED BLADE KNIVES
1-10-550 TITAN		•		•	•	•	
0-10-780 FATMAX®		•	•	•	•	•	
1-10-199 199E		•		•		•	
0-10-299 299		•		•		•	

REPLACEMENT BLADES OVERVIEW

TYPE	IMAGE	Plastic materials	Carpet	Special carpet cutter	Special safety knife	Textile	Hard plastics (precision)	Leather	Fine finish	Layered material
CARBIDE		•	•	•	•	•	•	•	•	•
FATMAX®		•	•	•	•	•	•	•	•	•
1991		•	•							
1992		•	•		•					
1992 ROUNDED					•					
1996			•	•						
5192								•		
1998		•						•		

WHICH SPARE BLADE FIT WHICH KNIFE?

TYPE	IMAGE	SPARE BLADE TYPES																					
		0-10-789	0-10-819	2-10-122	0-10-788	0-10-778	STHT10479-0	1-10-099	0-10-088	STHT10430-0	STHT10432-0	0-10-810	0-10-825	0-10-242	0-10-189	0-10-243	0-10-818	1-10-550	0-10-780	1-10-199	0-10-299	STHT10424-0	
CARBIDE		•	•	•	•	•	•	•	•	•	•	•	•	•	•	•	•	•	•	•	•	•	•
0-11-700		•	•	•	•	•	•	•	•	•	•	•	•	•	•	•	•	•	•	•	•	•	•
0-11-911 (1991)		•	•	•	•	•	•	•	•	•	•	•	•	•	•	•	•	•	•	•	•	•	•
0-11-921 (1992)		•	•	•	•	•	•	•	•	•	•	•	•	•	•	•	•	•	•	•	•	•	•
0-11-983 (1996)		•	•	•	•	•	•	•	•	•	•	•	•	•	•	•	•	•	•	•	•	•	•
1-11-967 (1995H)		•	•	•	•	•	•	•	•	•	•	•	•	•	•	•	•	•	•	•	•	•	•
0-11-952 (5192)		•	•	•	•	•	•	•	•	•	•	•	•	•	•	•	•	•	•	•	•	•	•
2-11-987							•	•	•	•			•	•	•								

CHANGING THE BLADE

Quickly and without extra tools, for most STANLEY knives.

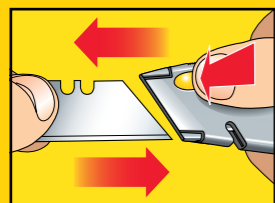

FAST BLADE CHANGE SYSTEM

By the simple push of a button can the blade be changed.

INTERLOCK SYSTEM

Exclusive STANLEY lock system ensures a perfect locking of the blade.

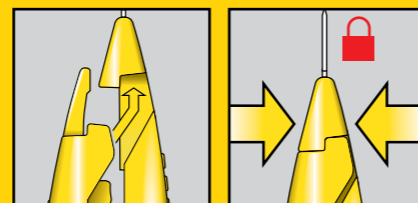

BLADE LOCKING SYSTEM WITH INTERLOCK BLADE

This allows the blade, even under great force, to not be pushed upwards.

RETRACTABLE BLADE KNIVES

STANLEY® FATMAX® PRO TWIN BLADE KNIFE



- Ergonomically shaped knife with 2 different blades
- Extra safety: while cutting with 1 blade, the other cannot be extended
- Quick blade change system by the simple push of a button
- Interlock nose locking system for greater safety during cutting
- Storage space for 5 Replacement blades
- Suitable for all standard STANLEY® Replacement blades
- Supplied with 2x 11-700 and 2x 11-983
- Length 180mm

CODE	DESCRIPTION	✉	☒	📦	PRICE
0-10-789	STANLEY® FATMAX® PRO Twin Blade Knife	X	6	3 253560 107895	

STANLEY® FATMAX® XTREME™ RETRACTABLE BLADE KNIFE



- Extra light, but indestructible aluminum housing
- Holds up to 15 Replacement blades
- Magnetic tip holds the Replacement blade in place when changing
- Rotary knob to adjust the blade opening when using extra sturdy Replacement blades
- Spring-loaded opening system for easy blade replacement
- Diamond embossed handle for better grip
- Supplied with 10 Replacement blades
- Length 205mm

CODE	DESCRIPTION	✉	☒	📦	PRICE
0-10-819	STANLEY® FATMAX® Xtreme™ Retractable Blade Knife	X	6	3 253560 108199	

TITAN RETRACTABLE BLADE KNIFE



- Dolphin shape ideal to cut without scrapping knuckles
- Suitable for heavy duty cutting applications
- Robust aluminum design
- Interlock nose locking system for greater safety during cutting
- Copper rotary knob to change and clamp blades
- Storage space for 7 Replacement blades in the handle
- Supplied with 3 Replacement blades
- Length 185mm

CODE	DESCRIPTION	✉	☒	📦	PRICE
2-10-122	Titan Retractable Blade Knife	X	12	3 253562 101228	

QUICK CHANGE KNIFE



- Metal design, durable and lightweight
- Bi-material soft handle
- Quick blade change system by the simple push of a button
- Interlock nose locking system for greater safety during cutting
- Cord cutter - works when blade is retracted
- Storage space for 8 Replacement blades in the handle
- Supplied with 3 Replacement blades
- Length 180mm

CODE	DESCRIPTION				PRICE
0-10-788	Quick change knife	X	6	2 5 3 5 6 0 1 0 7 8 8 8	

STANLEY® FATMAX® RETRACTABLE UTILITY KNIFE

STANLEY
FATMAX



- Ergonomic design
- Pop-up magazine for Replacement blades
- User-friendly blade change system - without tools
- 2 positions for the blade
- Supplied with 5 FATMAX® Replacement blades
- Length 170mm

CODE	DESCRIPTION				PRICE
0-10-778	FATMAX Retractable Utility Knife	X	6	2 5 3 5 6 0 1 0 7 7 8 9	
7-10-778	FATMAX Retractable Utility Knife - with 5 carbide blades	X	6	3253567107782	

AUTOLOAD RETRACTABLE KNIFE



- Autoload: automatic supply of new Replacement blade gives instant blade change, without touching the new blade. Simply pull out the used blade, pull the blade back and load up with a new, sharp blade
- Handle with magazine for 5 Replacement blades
- Narrow nose design is ideal for drywall applications
- Soft rubber grip for added comfort
- Quick blade change system with easy access to the Replacement blade magazine
- Suitable for all standard 1992 blades (11-921)
- Length 160mm

CODE	DESCRIPTION				PRICE
0-10-237	Retractable Knife Autoload	X	4	2 5 3 5 6 0 1 0 2 3 7 1	

RETRACTABLE KNIFE COMPACT



- Die-cast metal housing with bi-material handle for better grip
- Ergonomic design for extra control: slider position and blade change button on the side
- 4 extendable positions for depth control
- Quick blade change system by the simple push of a button
- Ergonomically shaped nose for precise cutting applications such as cable stripping
- Interlock nose locking system for greater safety during cutting
- Length 130mm

CODE	DESCRIPTION				PRICE
STHT10432-0	Retractable Knife Compact	X	6	2 5 3 5 6 0 1 0 4 3 2 0	

RETRACTABLE KNIFE SOFTGRIP



- Die-cast metal housing
- Ergonomic, bi-material handle for better grip
- 5 extendable positions for depth control
- Quick blade change system by the simple push of a button
- Interlock nose locking system for greater safety during cutting
- Handle with magazine for Replacement blades
- Supplied with 3 Replacement blades
- Length 170mm

CODE	DESCRIPTION				PRICE
STHT10479-0	Retractable Knife Softgrip	X	6	2 5 3 5 6 0 1 0 4 7 9 5	

RETRACTABLE KNIFE



- Die-cast metal housing
- Ergonomic, bi-material handle for better grip
- 5 extendable positions for depth control
- Quick blade change system by the simple push of a button
- Interlock nose locking system for greater safety during cutting
- Handle with magazine for Replacement blades
- Supplied with 3 Replacement blades
- Length 170mm

CODE	DESCRIPTION				PRICE
STHT10430-0	Retractable Knife	X	6	3 253560 104306	

RETRACTABLE KNIFE 99E



- Original retractable STANLEY® knife
- Zinc version, durable and light
- For left and right handed people
- 5 extendable positions for depth control
- Storage space for Replacement blades in the handle
- Interlock nose locking system for greater safety during cutting
- Supplied with 3 Replacement blades
- Length 155mm

CODE	DESCRIPTION				PRICE
2-10-099	Retractable Knife 99E	X	12	3 253562 100993	
1-10-099	Retractable Knife 99E	-	12	3 253561 100994	

RETRACTABLE KNIFE ABS



- Made of ABS plastic, durable and lightweight
- 5 extendable positions for depth control
- Snap lock for quick and easy blade changes; no more tools needed
- Supplied with 2 Replacement heavy duty blades (1992)
- Length 150mm

CODE	DESCRIPTION				PRICE
0-10-088	Retractable Knife ABS Plastic	X	12	3 253560 100889	

QUICK SLIDE KNIFE



- Suitable for all standard and hook Knives
- Innovative sliding system with automatic locking
- Change blades without tools
- 9-10-810: display 12 Knives
- Length 145mm

CODE	DESCRIPTION				PRICE
0-10-810	Quick Slide Knife	X	6	3 253560 108106	
9-10-810	Quick Slide Knife - Display x12	X	12	3253569108107	

STANLEY® FATMAX® FOLDING TWIN-BLADE RETRACTABLE KNIFE

**STANLEY
FATMAX**



- Duo extendable folding knife: 1 holder for 2 different Knives
- Quick change mechanism
- Longer life: use the right blade for the job
- Compact and convenient to store
- Length 180mm

CODE	DESCRIPTION				PRICE
XTHT0-10502	STANLEY® FATMAX® Folding Twin-Blade Retractable Knife	X	6	3 253560 105020	

STANLEY® FATMAX® RETRACTABLE FOLDING UTILITY KNIFE

**STANLEY
FATMAX**



- Sturdy, ergonomic design for heavy use
- Retractable Knife: safe and convenient
- Quick blade change system
- Magazine for Replacement blades
- Length 140mm

CODE	DESCRIPTION				PRICE
0-10-825	STANLEY® FATMAX® Retractable Folding Utility Knife	X	6	3 253560 108250	

SAFETY KNIVES OVERVIEW



	FILM CUTTERS			
ARTIKELCODE	STHT10355-1	STHT10356-0	FMHT10358-0	FMHT10373-0
MODEL	STANLEY® Single-Sided Pull Cutter (10 PK)	STANLEY® Single-Sided Bi-Material Pull Cutter	STANLEY® FATMAX® Single-Sided Replaceable Head Pull Cutter	STANLEY® FATMAX® Single-Sided Replaceable Blade Pull Cutter
DISPOSABLE	✓	✓		
BIMATERIAL GRIP		✓	✓	✓
METAL				
REPLACEABLE HEAD				
REPLACEABLE BLADE [1]				✓
LOCKABLE				
HEIGHT ADJUSTABLE BLADE				
SPARE BLADES STORAGE				
SELFRETRACTING				
AUTORETRACTING				



	SQUEEZE			TRISLIDE				
ARTIKELCODE	STHT10368-0	FMHT10369-0	FMHT10370-0	FMHT10365-0	FMHT10367-0	0-10-189	0-10-243	0-10-244
MODEL	STANLEY® Squeeze Self-Retract Safety Knife	STANLEY® FATMAX® Squeeze Bi-Material Auto-Retract Safety Knife	STANLEY® FATMAX® Squeeze Metal Auto-Retract Safety Knife	STANLEY® FATMAX® Tri-Slide Bi-Material Auto-Retract Safety Knife	STANLEY® FATMAX® Tri-Slide Metal Auto-Retract Safety Knife	Self-Retracting Safety Utility Knife	Pocket Folding Safety Knife	Safety Wrap Cutter
DISPOSABLE								
BIMATERIAL GRIP		✓	✓	✓	✓			
METAL			✓		✓	✓	✓	
REPLACEABLE HEAD								✓ [2]
REPLACEABLE BLADE [1]	✓	✓	✓	✓	✓			
LOCKABLE	✓	✓	✓	✓	✓			
HEIGHT ADJUSTABLE BLADE				✓	✓			
SPARE BLADES STORAGE				✓	✓	✓		
SELFRETRACTING	✓							
AUTORETRACTING		✓	✓	✓	✓			

[1] spare blades rounded tip - 10 pieces/dispenser - 2-11-987

[2] spare blade for shrink wrap - 0-10-245



SAFETY KNIFE

Safety first

Working safely on the jobsite can reduce the risk of injury. Reduce the risk of cuts and injuries using our full range of STANLEY® safety knives.

SAFETY KNIVES

SINGLE-SIDED PULL CUTTER (10 PK)



- Profiled handle - for optimal comfort and a perfect grip
- Hook awl - for piercing and cutting single and double wall corrugated board
- Recessed blade - less risk of injury
- Integrated splitter for plastic tape - for multifunctional convenience
- Lightweight construction - helps reduce operator fatigue, compared to heavier metal blades
- Attachment loop - for more security or to store the blade
- Length 170mm

CODE	DESCRIPTION				PRICE
STHT10355-1	Single-Sided Pull Cutter (10 PK)	X	10	3 2 5 3 5 6 1 1 0 3 5 5 1	

SINGLE-SIDED BI-MATERIAL PULL CUTTER



- Bi-material handle - for non-slip comfort and a perfect grip
- Hook awl - for piercing and cutting single and double wall corrugated board
- Recessed blade - less risk of injury
- Integrated splitter for plastic tape - for multifunctional convenience
- Lightweight construction - helps reduce operator fatigue, compared to heavier metal blades
- Attachment loop - for more security or to store the blade
- Length 170mm

CODE	DESCRIPTION				PRICE
STHT10356-0	Single-Sided Bi-Material Pull Cutter	X	50	3 2 5 3 5 6 0 1 0 3 5 6 9	

STANLEY® FATMAX® SINGLE-SIDED REPLACEABLE HEAD PULL CUTTER

STANLEY
FATMAX



- Interchangeable cutting head - for longer life & optimum cost efficiency
- Bi-material handle - for non-slip comfort and a perfect grip
- Hook awl - for piercing and cutting single and double wall corrugated cardboard
- Recessed blade - less risk of injury
- Integrated splitter for plastic tape - for multifunctional convenience
- Lightweight construction - helps reduce operator fatigue, compared to heavier metal blades
- Attachment loop - for more security or to store the blade
- Length 170mm

CODE	DESCRIPTION				PRICE
FMHT10358-0	STANLEY® FATMAX® Single-Sided Replaceable Head Pull Cutter	X	36	3 2 5 3 5 6 0 1 0 3 5 8 3	

STANLEY® FATMAX® SINGLE-SIDED REPLACEABLE BLADE PULL CUTTER

**STANLEY
FATMAX**



- Replaceable blades - easy to replace with standard blades
- Reusable product for longer life & optimal cost efficiency
- Recessed blade - less risk of injury & longer product life
- Bi-material handle - for non-slip comfort and a perfect grip
- Integrated splitter for plastic tape - for multifunctional convenience
- Lightweight construction - helps reduce operator fatigue, compared to heavier metal blades
- Attachment loop - for more security or to store the blade
- Length 180mm

CODE	DESCRIPTION				PRICE
FMHT10373-0	STANLEY® FATMAX® Single-Sided Replaceable Blade Pull Cutter	X	6	2 5 3 5 6 0 1 0 3 7 3 6	

SQUEEZE SELF-RETRACT SAFETY KNIFE



- Pinch trigger safety blade - improved ergonomics for use compared to a spring-loaded sliding pawl: less tension
- The blade automatically retracts when the pressure on the trigger disappears for greater safety
- Safety Knife - Supplied with 1x round tip safety knife
- Integrated safety lock - the blade can be locked to prevent accidental use
- Lightweight construction - helps reduce operator fatigue, compared to heavier metal blades
- Attachment loop - for more security or to store the blade
- Profiled handle - for optimal comfort and a perfect grip
- Quick blade change - more efficiency thanks to a quick, tool-free blade change
- Length 155mm

CODE	DESCRIPTION				PRICE
STHT10368-0	Squeeze Self-Retract Safety Knife	X	6	2 5 3 5 6 0 1 0 3 6 8 2	

STANLEY® FATMAX® SQUEEZE BI-MATERIAL AUTO-RETRACT SAFETY KNIFE

**STANLEY
FATMAX**



- Automatic safety blade with pinch trigger - improved ergonomics for use compared to a spring-loaded sliding pawl: less tension
- The blade retracts automatically when the pressure on the trigger disappears or when contact with the material is lost, for maximum safety
- Safety Knife - Supplied with 1x round tip safety knife
- Integrated safety lock - the blade can be locked to prevent accidental use
- Lightweight construction - helps reduce operator fatigue, compared to heavier metal blades
- Attachment loop - for more security or to store the blade
- Bi-material handle - for non-slip comfort and a perfect grip
- Quick blade change - more efficiency thanks to a quick, tool-free blade change
- Length 160mm

CODE	DESCRIPTION				PRICE
FMHT10369-0	STANLEY® FATMAX® Squeeze Bi-Material Auto-Retract Safety Knife	X	6	2 5 3 5 6 0 1 0 3 6 9 9	

STANLEY® FATMAX® SQUEEZE METAL AUTO-RETRACT SAFETY KNIFE

**STANLEY
FATMAX**



- Automatic safety blade with pinch trigger - improved ergonomics for use compared to a spring-loaded sliding pawl: less tension
- The blade retracts automatically when the pressure on the trigger disappears or when contact with the material is lost, for maximum safety
- Safety Knife - Supplied with 1x round tip safety knife
- Integrated safety lock - the blade can be locked to prevent accidental use
- Metal construction - for unparalleled strength & durability in demanding conditions
- Attachment loop - for more security or to store the blade
- Bi-material handle - for non-slip comfort and a perfect grip
- Quick blade change - more efficiency thanks to a quick, tool-free blade change
- Length 160mm

CODE	DESCRIPTION				PRICE
FMHT10370-0	STANLEY® FATMAX® Squeeze Metal Auto-Retract Safety Knife	X	6	2 5 3 5 6 0 1 0 3 7 0 5	

STANLEY® FATMAX® TRI-SLIDE BI-MATERIAL AUTO-RETRACT SAFETY KNIFE

**STANLEY
FATMAX**



- Automatic safety blade - the blade automatically retracts when the pressure on the trigger disappears or when contact with the material is lost, for maximum safety
- Adjustable blade height & lock - 3 positions for different materials & applications + LOCK for safe storage and transport of the blade
- Integrated knife storage - for greater convenience
- Supplied with 4x round tip safety blades (1 on blade, 3 in storage)
- Lightweight construction - helps reduce operator fatigue, compared to heavier metal blades
- Attachment loop - for more security or to store the blade
- Bi-material handle - for non-slip comfort and a perfect grip
- Quick blade change - more efficiency thanks to a quick, tool-free blade change
- Length 180mm

CODE	DESCRIPTION				PRICE
FMHT10365-0	STANLEY® FATMAX® Tri-Slide Bi-Material Auto-Retract Safety Knife	X	6	2 5 3 5 6 0 1 0 3 6 5 1	

STANLEY® FATMAX® TRI-SLIDE METAL AUTO-RETRACT SAFETY KNIFE

**STANLEY
FATMAX**



- Automatic blade - the blade retracts automatically when the pressure on the trigger disappears or when contact with the material is lost, for maximum safety
- Adjustable blade height & lock - 3 positions for different materials & applications + LOCK for safe storage and transport of the blade
- Integrated knife storage - for greater convenience
- Supplied with 4x round tip safety blades (1 on blade, 3 in storage)
- Metal construction - for unparalleled strength & durability in demanding conditions
- Attachment loop - for more security or to store the blade
- Bi-material handle - for non-slip comfort and a perfect grip
- Quick blade change - more efficiency thanks to a quick, tool-free blade change
- Length 180mm

CODE	DESCRIPTION				PRICE
FMHT10367-0	STANLEY® FATMAX® Tri-Slide Metal Auto-Retract Safety Knife	X	6	3	2 5 3 5 6 0 1 0 3 6 7 5

SELF-RETRACTING SAFETY UTILITY KNIFE



- User-friendly steel safety knife
- Blade retracts automatically when slide button is released
- Heavy duty rounded blade (included)
- Length 155mm

CODE	DESCRIPTION				PRICE
0-10-189	Self-Retracting Safety Utility Knife	X	6	3	2 5 3 5 6 0 1 0 1 8 9 3
1-10-189	Self-Retracting Safety Utility Knife	-	12	3	2 5 3 5 6 1 1 0 1 8 9 2

POCKET FOLDING SAFETY KNIFE



- Automatic retractable blade for safety
- Pocket size for easy storage
- Including tape cutter for opening boxes
- Recommended replacement blades: 2-11-987 round nose blade or any 1992 series blades (11-921)
- Length 160mm

CODE	DESCRIPTION				PRICE
0-10-243	Pocket Folding Safety Knife	X	24	3	2 5 3 5 6 0 1 0 2 4 3 2

SAFETY WRAP CUTTER



- Pocket shrink wrap cutter with tape cutter
- The blade can be replaced

CODE	DESCRIPTION				PRICE
0-10-244	Safety Wrap Cutter	X	6	3	2 5 3 5 6 0 1 0 2 4 4 9
0-10-245	Replacement blade Safety Wrap Cutter	X	6	3	2 5 3 5 6 0 1 0 2 4 5 6

FIXED BLADE KNIVES

STANLEY® FATMAX® XTREME™ FIXED BLADE KNIFE

STANLEY
FATMAX



- Extra light, but indestructible aluminum housing
- Holds up to 15 Replacement blades
- Magnetic tip holds the Replacement blade in place while changing
- Rotary knob to adjust the blade opening when using extra sturdy Replacement blades
- Spring-loaded opening system for easy blade replacement
- Embossed handle for better grip
- Supplied with 10 Replacement blades
- Length 205mm

CODE	DESCRIPTION				PRICE
0-10-818	STANLEY® FATMAX® Xtreme™ Fixed Blade Knife	X	6		

TITAN FIXED BLADE KNIFE WITH SCABBARD



- Professional fixed blade knife
- Curved shape for better grip and finger protection while cutting
- Suitable for heavy duty cutting applications
- Robust aluminum design, light and durable
- Copper rotary knob to change and clamp blades
- Supplied with 3 Replacement blades
- Length 175mm

CODE	DESCRIPTION				PRICE
2-10-550	Titan Fixed Blade Knife with Scabbard	X	12		
1-10-550	Titan Fixed Blade Knife with Scabbard with Holster	-	12		

STANLEY® FATMAX® FIXED BLADE KNIFE

STANLEY
FATMAX



- Blade cleaner to remove dirt and dust when storing the blade
- Blade lock when cutting for safety and accuracy
- Ergonomic design
- Pop-up magazine for 5 Replacement blades
- User-friendly blade change system - without tools
- 2 positions for the blade
- Supplied with 5 FATMAX® Replacement blades
- Length 170mm

CODE	DESCRIPTION				PRICE
0-10-780	STANLEY® FATMAX® Fixed Blade Knife	X	6		

FIXED BLADE KNIFE 199E



- Original STANLEY® knife
- Aluminum design, durable and light
- Interlock nose locking system for greater safety during cutting
- Magazine for Replacement blades in handle
- Supplied with 3 Replacement blades
- Length 140mm

CODE	DESCRIPTION				PRICE
10-2-199	Fixed Blade Knife 199E	X	12		
1-10-199	Fixed Blade Knife 199E	-	12		

FIXED BLADE KNIFE 299



- Original STANLEY® fixed blade knife
- Aluminum design, durable and light
- Interlock nose locking system for greater safety during cutting
- Magazine for Replacement blades in handle
- Supplied with 1 Replacement blade
- Length 136mm

CODE	DESCRIPTION				PRICE
0-10-299	Fixed Knife 299	X	12		

FATMAX® FOLDING FIXED BLADE KNIFE

STANLEY
FATMAX



- Ergonomic design for ease of use in heavy duty applications
- Metal housing for longer life
- Bi-material handle for added comfort and control
- Tape cutter to open packages without damaging the contents
- Quick change mechanism
- Magazine for Replacement blades in the handle
- Equipped with handy Belt clip
- Length 160mm

CODE	DESCRIPTION				PRICE
FMHT0-10827	FATMAX Folding Fixed Blade Knife	-	36		

FOLDING FIXED BLADE UTILITY KNIFE



- Quick blade change system by the simple push of a button
- Compact and light aluminum design
- Fixed blade with a corrosion-resistant folding mechanism
- Belt clip

CODE	DESCRIPTION				PRICE
STHT10424-0	Folding Fixed Blade Utility Knife	X	6		



REPLACEMENT BLADES

CARBIDE REPLACEMENT BLADES

**STANLEY
FATMAX**

UNIQUE Replacement blade WITH NEW PATENTED TECHNOLOGY

IMPROVED DURABILITY
lasts up to 10x longer than existing Replacement blades

CUTTING EDGE FINISHED WITH TUNGSTEN CARBIDE AND INDUCTION HARDENED
allowing the rest of the blade to maintain its flexibility

REPLACEMENT BLADES WITH THE LONGEST LIFE

Length: 62mm
Thickness: 0.60mm
Height: 19mm

CODE	DESCRIPTION				PRICE
0-11-800	Carbide Replacement blade - 5 pcs	X	10		
2-11-800	Carbide Replacement blade - 10 pcs	X	10		
8-11-800	Carbide Replacement blade - 50 pcs	X	6		

STANLEY CARBIDE BLADE TECHNOLOGY

- High speed laser application creates a very strong and durable cutting edge
- Tungsten Carbide powder is applied to the cutting edge by a specially developed laser
- Diamond wheels sharpen the blade after the Carbide has been applied to the blade
- Because only the cutting edge is finished with Carbide, the rest of the knife remains flexible

FEATURES & BENEFITS

- The blade with the longest life
- Lasts more than 10x longer than existing replacement blades

Tungsten Carbide is the most durable and hardest material after diamond Carbide finished cutting edge and strong steel blade - **very flexible so that the blade does not break easily**

FATMAX® REPLACEMENT BLADES

STANLEY
FATMAX



- Replacement blade with patented induction hardened edges
- Stays sharper 75% longer
- 2x longer service life
- Cutting edges 20% stronger
- Does not break - resistance up to 35 kg
- Suitable for all cutting applications
- Length 63mm
- Thickness 0.65mm
- Height 20mm

CODE	DESCRIPTION				PRICE
0-11-700	FATMAX Replacement blade - 5 pcs	X	10	3 253560 117009	
1-11-700	FATMAX Replacement blade - 100 pcs	-	6	3 253561 117008	
11-2-700	FATMAX Replacement blade - 10 pcs	X	10	3 253562 117007	
4-11-700	FATMAX Replacement blade - 50 pcs	-	6	3 253564 117005	

REPLACEMENT BLADES 1991



- Short model
- For general cutting - suitable for paper, cardboard etc.
- Length 50mm
- Thickness 0.43mm
- Height 19mm

CODE	DESCRIPTION				PRICE
0-11-911	Replacement blades 1991 without holes - 5 pcs/card	X	10	5 000366 119113	
1-11-911	Replacement blades 1991 without holes - box 100	-	1	3 253561 119118	
2-11-911	Replacement blades 1991 without holes - 10 pcs/dispenser	X	10	3 253562 119117	

REPLACEMENT BLADES 1992



- Long model
- Strong replacement blade suitable for heavy cutting such as carpets, vinyl
- Length 62mm, thickness 0.65mm, height 19mm

CODE	DESCRIPTION				PRICE
0-11-921	Replacement blades 1992 without holes - 5 pcs/card	X	10	5 000366 119212	
1-11-921	Replacement blades 1992 without holes - box 100	-	1	3 253561 119217	
2-11-921	Replacement blades 1992 without holes - 10 pieces/dispenser	X	10	3 253562 119216	
3-11-921	Replacement blades 1992 without holes - Dispenser x10 carded	X	10	3253563119215	
8-11-921	Replacement blades 1992 without holes - 100 pcs/dispenser	X	6	3 253568 119210	
3-11-916	Replacement blades 1992 with holes - 5 pcs			3253563119161	
6-11-916	Replacement blades 1992 with holes - 10 pcs			3253566119168	
1-11-916	Replacement blades 1992 with holes - bulk x100			3253561119163	

REPLACEMENT BLADES WITH ROUNDED TIP



- Rounded corners for safety and to prevent material damage
- Length 62mm
- Thickness 0.65mm
- Height 19mm

CODE	DESCRIPTION				PRICE
2-11-987	Replacement blades Rounded Point - 10 pieces/dispenser	X	10	3 253562 119872	

REPLACEMENT BLADES 1996



- Hook blade with sharp point for piercing and cutting carpeting and plastic, packaging material
- Length 50mm
- Thickness 0.65mm
- Height 19mm

CODE	DESCRIPTION				PRICE
0-11-983	Replacement blades 1996 without holes - 5 pcs/card	X	10	5 000366 119818	
11-1-983	Replacement blades 1996 without holes - box 100	-	1	3 253561 119835	
2-11-983	Replacement blades 1996 without holes - 10 pcs/dispenser	X	10	3 253562 119834	
1-11-802	Replacement blades 1996N with holes - box 100	X	1	3253561118029	
6-11-802	Replacement blades 1996 with holes - box 100	X	1	3253566118024	

REPLACEMENT BLADES 1995 H

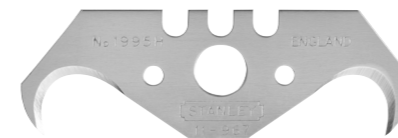

- Special hook blades for cutting thick carpet
- With large hole for carpet cutters and sharp points
- Length 55mm
- Thickness 0.65mm
- Height 19mm

CODE	DESCRIPTION				PRICE
1-11-967	Replacement blades 1995H - box 100	-	1	3 253561 119675	

REPLACEMENT BLADES 5192



- Replacement blade with concave cutting edges, ideal for cutting out leather and inlays
- Length 60mm
- Thickness 0.65mm
- Height 19mm
- Suitable for all Knives except 10-550 (Fixed Knife Titan) and 10-199 (Fixed Knife 199E)

CODE	DESCRIPTION				PRICE
0-11-952	Replacement blades 5192 - 5 pcs/card	X	10	2 5 3 5 6 0 1 1 9 5 2 2	
1-11-952	Replacement blades 5192 - box 100	-	2	2 5 3 5 6 1 1 1 9 5 2 1	

SNAP-OFF BLADE KNIVES

FATMAX® SNAP-OFF KNIFE QUICK SNAP 18 MM

**STANLEY
FATMAX**

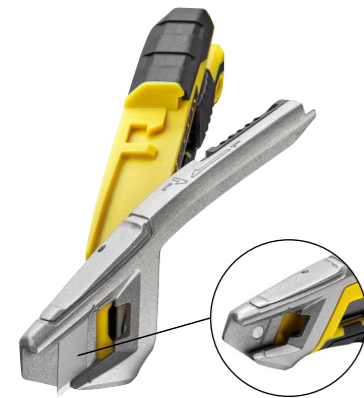

QUICK, EASY & SAFE DISMANTLING
Integrated, one-handed snap mechanism with magnet to hold the broken blade segment

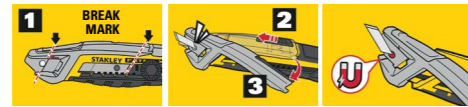

ERGONOMIC
Bi-material housing for better grip and control



STAINLESS STEEL VERSION
for ease of use, sturdiness and longer life

TETHER READY ATTACHMENT POINT

BETTER DEPTH CONTROL
Self-locking blade slide system.

ALSO AVAILABLE WITH WHEEL LOCK
FMHT10592-0



CODE	DESCRIPTION	✉	☒	📊	PRICE
FMHT10594-0	FATMAX Snap-Off Knife Quick Snap 18 mm - Length: 165 mm	X	6	3 2535601105945	
FMHT10592-0	FATMAX Snap-Off Knife Quick Snap with wheel lock -18 mm - Length: 165 mm	X	6x	3253560105921	

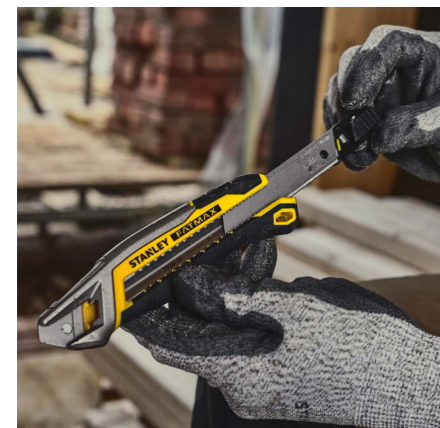

STANLEY® FATMAX® 9MM SNAP-OFF KNIFE



- Diamond shaped texturing provides sure grip
- Die cast all metal construction stands up to the most extreme job site
- Textured die cast finish for positive slip-resistant grip

CODE	DESCRIPTION	✉	☒	📊	PRICE
0-10-820	STANLEY® FATMAX® 9 mm Snap-Off Knife	X	6		

STANLEY® FATMAX® PRO 25 MM SNAP-OFF KNIFE

**STANLEY
FATMAX**



- Holds up to 4 snap-off blades
- Automatic blade change system
- Self-locking blade slide system
- Blocking screw on end use during heavy duty applications
- With built-in cap to break off blade segments
- Available in 25mm with 7 segments

CODE	DESCRIPTION	✉	☒	📊	PRICE
0-10-820	STANLEY® FATMAX® Pro 25 mm Snap-Off Knife	X	6	3 2535601108205	

FATMAX® SNAP-OFF KNIFE METAL 25 MM, 18 MM OR 9 MM

**STANLEY
FATMAX**



- Die-cast zinc housing for strength and durability
- Streamlined design for good control and accuracy
- Blocking screw
- Built-in end cap to break off blade segments
- Belt clip
- Available in: 25mm (0-10-431), 18mm (0-10-421) and 9mm (0-10-411)

CODE	DESCRIPTION	✉	☒	📊	PRICE
0-10-431	FATMAX Snap-Off Knife Metal 25 mm - Length: 195 mm	X	24	3 2535601104313	
0-10-421	FATMAX Snap-Off Knife Metal 18 mm - Length: 155 mm	X	4	3 2535601104214	
0-10-411	FATMAX™ Snap-Off Knife Metal 9 mm - Length: 135 mm	X	6	3 2535601104115	

FATMAX® SNAP-OFF BLADE - SCREW BUTTON OR SLIDER - 25 MM OR 18 MM

**STANLEY
FATMAX**



- Blade change system at the front
- Patented housing design
- Ergonomic bi-material grip
- Plastic housing with metal blade holder
- Large wheel blade lock for heavy duty cutting
- Thumb recess for better comfort & control while cutting
- Tether ready attachment point

CODE	DESCRIPTION	✉	☒	📊	PRICE
FMHT10330-0	FATMAX Snap-Off Knife with Screw Knob 25mm - Length: 205mm	X	24	3 2535601103309	
FMHT10329-0	FATMAX Snap-Off Knife with Screw Knob 18mm - Length: 175mm	X	36	3 2535601103293	
FMHT10338-0	FATMAX Snap-Off Knife slider 18mm - Length: 175mm	X	36	3253560103385	

FATMAX® SNAP-OFF BLADE KNIFE 25 MM, 18 MM OR 9 MM

STANLEY
FATMAX



- Stainless steel construction for ease of use, sturdiness and long life
- Magazine with 4 Replacement snap-off blades for quick and automatic blade change
- Bi-material, ergonomic slider
- Removable breaking cap to break off the old blade segment safely and quickly
- Resistant to 20kg of compressive force when cutting
- Available in: 25mm (0-10-486), 18mm (0-10-481) and 9mm (0-10-475)

CODE	DESCRIPTION	☐	☒	☐	PRICE
0-10-486	FATMAX Snap-off Knife 25 mm - Length: 215 mm	X	6	3	2 5 3 5 6 0 1 0 4 8 6 3
0-10-481	FATMAX Snap-off Knife 18 mm - Length: 180 mm	X	6	3	2 5 3 5 6 0 1 0 4 8 1 8
0-10-475	FATMAX Snap-Off Knife 9 mm - Length: 138 mm	X	6	3	2 5 3 5 6 0 1 0 4 7 5 7

SNAP-OFF KNIFE DYNAGRIP® 25 MM



- Stainless design, easy to use, long service life
- Large wheel blade lock for heavy duty cutting
- Comfortable bi-material soft elastomer handle
- Blade: 25 mm wide and 0.7 mm thick, for heavy work
- Each snap-off blade has 6 blade segments
- Supplied with 1 Replacement snap-off blade

CODE	DESCRIPTION	☐	☒	☐	PRICE
0-10-425	Snap-off knife Dynagrip 25 mm - Length: 180 mm	X	6	3	2 5 3 5 6 0 1 0 4 2 5 2
1-10-425	Snap-off knife Dynagrip 25 mm - Length: 180 mm	-	6	3	2 5 3 5 6 1 1 0 4 2 5 1

SNAP-OFF KNIFE DYNAGRIP® WITH MAGAZINE 18 MM



- Snap-off blade with automatic blade change system
- Stainless steel construction for ease of use, sturdiness and long life
- Bi-material soft elastomer handle
- Magazine suitable for 6 Replacement snap-off Knives
- Ribbed locking screw, adjustable with thumb, for secure blade locking
- Built-in end cap to break off the old blade segment
- Supplied with 6 Replacement snap-off blades

CODE	DESCRIPTION	☐	☒	☐	PRICE
STHT10270-0	Snap-off knife Dynagrip with magazine 18 mm - Length: 175 mm	X	72	3	2 5 3 5 6 0 1 0 2 7 0 8

STANLEY® FATMAX® SNAP OFF KNIFE IN 18MM - DISPLAY



- Cast aluminium body for durability
- Slim-line design for ease of control, precision cutting and convenient storage
- Pocket clip – portable and easy to store

CODE	DESCRIPTION	☐	☒	☐	PRICE
8-10-421	STANLEY® FATMAX® SNAP OFF KNIFE IN 18MM - DISPLAY	X	72	3	2 5 3 5 6 0 1 0 2 7 0 8

SNAP-OFF BLADE KNIFE INTERLOCK 18 MM OR 9 MM

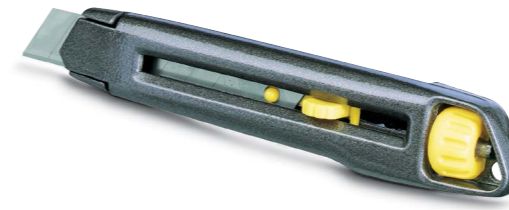

- Metal design, durable and lightweight
- Interlock nose locking system for greater safety during cutting
- User-friendly blade change system, no tools required
- In the extended position, the blade is immovably clamped and cannot unintentionally snap back
- Convenient to clean
- Available in: 18mm (10-018) and 9mm (10-095)

CODE	DESCRIPTION	☐	☒	☐	PRICE
0-10-018	Interlock Snap-Off Knife 18 mm - Length: 165 mm	X	12	3	2 5 3 5 6 0 1 0 0 1 8 6
1-10-018	Interlock Snap-Off Blade 18 mm - Length: 165 mm	-	12	3	2 5 3 5 6 1 1 0 0 1 8 5
0-10-095	Interlock Snap-Off Knife 9 mm - Length: 135 mm	X	12	3	2 5 3 5 6 0 1 0 0 9 5 7

SNAP-OFF BLADE KNIFE 18 MM



- Stainless version: user-friendly, long service life
- Ergonomic shape for comfortable grip in all conditions
- Large wheel blade lock for heavy duty cutting during heavy duty cutting applications
- Knurled housing for extra locking
- Supplied with 1 Replacement blade

CODE	DESCRIPTION	☐	☒	☐	PRICE
STHT10268-0	Snap-off knife 18 mm - Length: 165 mm	X	6	3	2 5 3 5 6 0 1 0 2 6 8 5
STHT10268-1	Snap-off knife 18 mm - Length: 165 mm - bulk x12	-	72	3	2 5 3 5 6 1 1 0 2 6 8 4

SNAP-OFF KNIFE TPR 9 MM



- Stainless version: user-friendly, long life
- Ergonomic shape for comfortable grip in all conditions
- Large wheel blade lock for heavy duty cutting during heavy duty cutting applications
- Knurled housing for extra locking
- Supplied with 1 Replacement blade

CODE	DESCRIPTION	☐	☒	☐	PRICE
0-10-409	Snap-off knife TPR 9 mm - Length: 135 mm	X	12	3	2 5 3 5 6 0 1 0 4 0 9 2

DYNAGRIP® 18 MM X 165 MM SNAP-OFF BLADE KNIFE



- Blade carrier and blade guide in stainless steel for smooth operation, strength and longlife
- Ergonomic and strong handle for long life
- Large wheel blade lock for heavy duty cutting
- Quick and easy blade change through notched wheel no tools required

CODE	DESCRIPTION	☐	☒	☐	PRICE
0-10-418	DynaGrip® 18 mm x 165 mm Snap-off Blade Knife	X	12		3253560104184
1-10-418	DynaGrip® 18 mm x 165 mm Snap-off Blade Knife - bulk x12	X	12		3253561104183

SNAP-OFF BLADE KNIFE AUTOLOCK 18 MM OR 9 MM



- Ergonomic design with soft bi-material handle for greater comfort and control
- Tapered center section for extra control and cutting precision
- Stainless steel slider with automatic locking secures the blade
- Supplied with 3 Replacement blades and a removable blade breaker
- Ideal for all light, medium and heavy cutting applications
- Available in: 18mm (STHT10266) and 9mm (STHT0-10264)

CODE	DESCRIPTION				PRICE
STHT10266-0	Snap-off knife Autolock 18 mm	X	6		
STHT10266-1	Snap-off knife Autolock 18 mm	-	12		

SNAP-OFF BLADE KNIFE 18 MM



- Tapered center section for extra control and cutting precision
- Stainless steel slide with automatic locking secures the blade
- Supplied with 3 Replacement blades and a removable blade breaker
- Ideal for all light, medium and heavy cutting applications

CODE	DESCRIPTION				PRICE
STHT10265-0	Snap-off blade 18 mm	X	72		
STHT10266-0	Snap-off blade 18 mm - 3 blades	X	72	3253560102661	
STHT10266-1	Snap-off blade 18 mm - bulk x12	-	12	3253561102660	

SNAP-OFF BLADE KNIFE HYBRID 18 MM



- Hybrid housing: combination of ABS and metal
- Secure slider
- Removable cap to safely break off blade segments
- Supplied with 1 Replacement snap-off blade

CODE	DESCRIPTION				PRICE
STHT10345-0	Snap-off knife hybrid 18 mm - Length: 160 mm	X	144		

SNAP-OFF BLADE KNIFE SM 18 MM OR 9 MM



- ABS version
- Secure slider
- Removable cap to safely break off blade segments
- Supplied with 1 Replacement snap-off blade
- Available in: 18mm (1-10-151) and 9mm (0-10-150)

CODE	DESCRIPTION				PRICE
0-10-151	Snap-off knife SM 18 mm - Length: 160 mm	X	12		
1-10-151	Snap-off knife SM 18 mm - Length: 160 mm	-	24		
0-10-150	Snap-off knife SM 9 mm - Length: 130 mm	X	24		
1-10-150	Snap-off knife SM 9 mm - Length: 130 mm	-	24		
STHT10202-0	Snap-off knife SM kit - 9 mm & 18 mm	X	12	3253560102029	
STHT10151-2	Snap-off knife SM kit - 3x 18 mm	X		3253562101518	
2-10-150	Snap-off knife SM kit - 3x 9 mm Polybag	X		3253562101501	
1-10-150	Snap-off knife SM 9 mm - bulk x24	-	-	3253561101502	

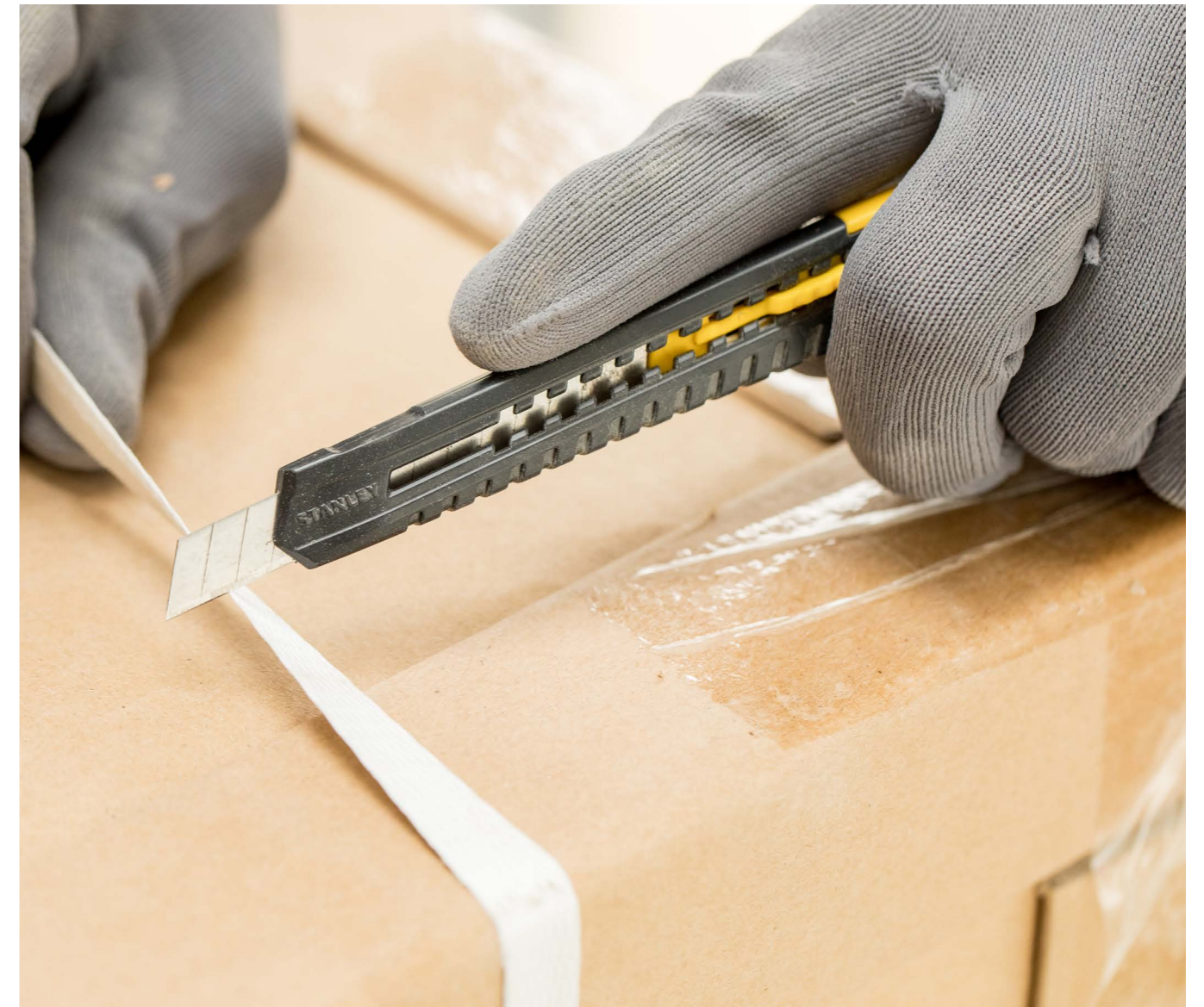

REPLACEMENT SNAP-OFF BLADES

CARBIDE REPLACEMENT SNAP-OFF BLADES 25 MM

- Unique Replacement blade with new patented technology
- Replacement blade with longest service life
- Improved durability – lasts up to 5x longer than existing replacement blades
- Cutting edge finished with Tungsten Carbide and induction hardened, so that the rest of the knife retains its flexibility



CODE	DESCRIPTION				PRICE
STHT0-11825	Carbide snap-off blades 25 mm (5 pieces)	X	6		
STHT3-11825	Carbide snap-off blades 25 mm (20 pieces)	X	10		

FATMAX® REPLACEMENT SNAP-OFF BLADES 25 MM

STANLEY
FATMAX

- Replacement snap-off blade with patented induction hardened edge
- 75% sharper*
- 2x longer lifespan*
- 20% stronger*
- Suitable for all cutting applications



CODE	DESCRIPTION				PRICE
0-11-725	FATMAX Replacement Snap-off Blade - 25 mm (5 pcs)	X	6		
2-11-725	FATMAX Replacement Snap-off Blade - 25 mm (10 pcs)	X	10		
3-11-725	FATMAX Replacement Snap-off Blade - 25 mm (20 pcs)	-	10		

REPLACEMENT SNAP-OFF BLADES 25 MM

- 25mm Replacement blade with 6 segments
- Thickness 1mm
- For professional applications
- Suitable for 10-425



CODE	DESCRIPTION				PRICE
0-11-325	Replacement snap-off blades 25 mm - 10 pieces/dispenser	X	10		
1-11-325	Replacement snap-off blades 25 mm - bulk 20	-	10		

CARBIDE REPLACEMENT SNAP-OFF BLADES 18 MM

- Unique Replacement blade with new patented technology
- Replacement blade with longest service life
- Improved durability – lasts up to 5x longer than existing replacement blades
- Cutting edge finished with Tungsten Carbide and induction hardened, so that the rest of the knife retains its flexibility



CODE	DESCRIPTION				PRICE
STHT0-11818	Carbide snap-off blades 18 mm (5 pieces)	X	10		
STHT2-11818	Carbide snap-off blades 18 mm (10 pieces)	X	10		
STHT8-11818	Carbide snap-off blades 18 mm (50 pieces)	X	10		

FATMAX® REPLACEMENT SNAP-OFF BLADES 18 MM

STANLEY
FATMAX

- Replacement snap-off blade with patented induction hardened edge
- 75% sharper*
- 2x longer lifespan*
- 20% stronger*
- Suitable for all cutting applications

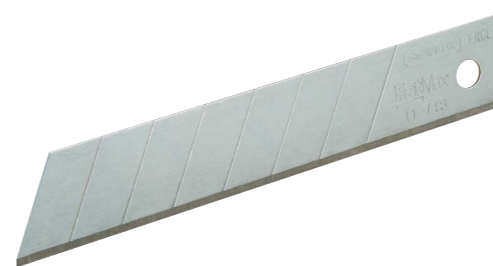

CODE	DESCRIPTION				PRICE
0-11-718	FATMAX Replacement Snap-off Blade 18 mm (5 pieces)	X	10		
2-11-718	FATMAX Replacement Snap-Off Knife 18 mm (10 pcs)	X	10		
3-11-718	FATMAX Replacement Snap-off Blade 18 mm (50 pieces)	-	W10		

REPLACEMENT SNAP-OFF BLADES 18 MM DISPENSER

- 18mm Replacement blade with 8 segments
- For heavy duty applications
- Thickness 0.63mm
- Suitable for 10-218, 10-418, 10-280, 10-380, 10-480

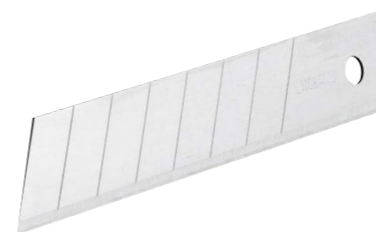

CODE	DESCRIPTION				PRICE
0-11-219	Replacement snap-off blades 18 mm - 8 pieces/dispenser	X	10		

REPLACEMENT SNAP-OFF BLADES 18 MM

- 18mm Replacement blade with 8 segments
- Thickness 0.55mm
- Suitable for all 18 mm snap-off Knives



CODE	DESCRIPTION				PRICE
0-11-301	Replacement snap-off blades 18 mm - 10 pieces/dispenser	X	10		
2-11-301	Replacement snap-off blades 18 mm - 5-pack carton	X	10	3253562113016	
1-11-301	Replacement snap-off blades 18 mm - 10 pcs/dispenser x 10	-	1		
3-11-301	Replacement snap-off blades 18 mm - box 50	-	16		

REPLACEMENT SNAP-OFF BLADES 9 MM

- 9mm Replacement blade with 12 segments
- Suitable for all 9.5 mm snap-off Knives



CODE	DESCRIPTION				PRICE
0-11-300	Replacement snap-off blades 9 mm - 10 pieces/dispenser	X	10		
1-11-300	Replacement snap-off blades 9 mm - 10 pcs/dispenser x 10	-	1		

HOBBY/SPORTS KNIVES

HOBBY KNIFE



- For very fine and very precise cutting
- With round metal handle
- Supplied with Replacement blade 11-411

CODE	DESCRIPTION				PRICE
0-10-401	Hobby knife 120 mm	X	5		

HOBBY KNIFE SET



- Two handle sizes for flexibility
- 12 different types of blades for a wide range of materials and applications, including high-precision cutting, deburring, marquetry, modeling, stenciling and etching
- Safe, easy-to-use bin for both new and used blades
- Storage box for safe storage - slide the handle over the blade and twist to remove it from the holder

CODE	DESCRIPTION				PRICE
STHT0-73872	Hobby knife set	-	72		

DISPOSABLE KNIVES



- Precision blade
- Plastic handle
- Supplied with protective cover for Knives (5901)

CODE	DESCRIPTION				PRICE
0-10-601	Disposable Knives 140 mm - 3 pcs	X	12		
1-10-601	Disposable Knives 140 mm - 50 pcs	-	1		

FOLDABLE HOBBY POCKET KNIFE



- Metal housing
- Foldable blade with locking mechanism
- Supplied with disposable blade (5901)

CODE	DESCRIPTION				PRICE
0-10-598	Pocket knife 110 mm	X	12		

INTERLOCK HOBBY KNIFE



- Exclusive INTERLOCK system that allows efficient lateral blade locking
- Quick and easy blade change through notched wheel no tools required
- Supplied with 5 blades in the integrated blade holder

CODE	DESCRIPTION				PRICE
0-10-590	Interlock Hobby Knife 175 mm	X	12	3253560105907	

QUICKSLIDE™ SPORT UTILITY KNIFE



- Durable aluminum housing
- No tools needed to change utility blade – quick and easy to replace blades.
- Suitable for cutting yarn, rope, nylon
- Knives cannot be used simultaneously due to built-in safety system
- Change blades quickly and without tools

CODE	DESCRIPTION				PRICE
0-10-813	QuickSlide™ Sport Utility Knife	X	2	3 253560 108137	
9-10-813	QuickSlide™ Sport Utility Knife - Display x12	X	12	3253569108138	

SKELETON LINER LOCK KNIFE



- Foldable sports knife
- Rockwell tested steel - guaranteed toughness
- Titanium coated blade for longer life
- Length 173mm

CODE	DESCRIPTION				PRICE
0-10-253	Skeleton Liner Lock Knife	-	6	3 253560 102531	

ROTARY CUTTER



- Suitable for cutting curved lines
- Ergonomic handle, for both left and right handed people
- Length 175mm

CODE	DESCRIPTION				PRICE
STHT0-10194	Rotary Cutterx 45 mm	X	4	3 253560 101947	

ALL PURPOSE KNIFE - STAINLESS STEEL BLADE



- 1.5mm stainless steel blade
- A better choice for use around water, especially salt water
- Blade length 90mm
- Knife blades hardened to 60 HRC - for added durability and life
- Holster with belt clip for convenient knife transport
- Soft grip design for comfortable extended heavy duty use
- Ground and hand sharpened - for extended first cut sharpness

CODE	DESCRIPTION				PRICE
0-10-232	All purpose Knife - Stainless steel			3253560102326	

STANLEY DECORATORS SNAP-OFF KNIFE WITH HOLSTER



- In built carpet tucker
- Grooved handle for good grip
- Comes with 10 blades + holster

CODE	DESCRIPTION				PRICE
STHT7-10220	Stanley decorators snap-off knife with holster			3253567102206	

REPLACEMENT BLADES HOBBY/SPORT

REPLACEMENT SLIM KNIFE BLADE 5901



- Knife with straight cutting edge for crafts and model making
- Thickness 0.63mm
- Length 60mm
- Suitable for 0-10-598

CODE	DESCRIPTION				PRICE
0-11-221	Replacement Slim Knife Blade 5901 - 3 pcs/card	X	10		
1-11-221	Replacement Slim Knife Blade 5901 - box 50	-	2		

REPLACEMENT BLADE HOBBY KNIVES 10-401

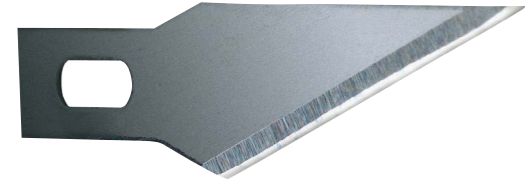

- Knife with long oblique cutting edge for fine carving such as illustrations, inlays and veneers
- Hardened and tempered steel for longer life
- Length 45mm
- Suitable for Hobby knife 10-401

CODE	DESCRIPTION				PRICE
0-11-411	Replacement blade Hobby Knives 10-401 - 5 pcs/card	X	10		

GLASS SCRAPERS

GLASS SCRAPER 2-SIDED



- 0-28-631 suitable for 0-28-616
- 0-28-290 suitable for 0-28-617
- 0-28-292 suitable for 0-28-619

CODE	DESCRIPTION				PRICE
0-28-616	Glass scrapers 25 mm	X	6		
0-28-631	Replacement blades 25 mm for 0-28-616 - 2 pcs/card	X	5		
0-28-617	Glass scraper 38 mm [6]	X	6		
0-28-290	Replacement blade 38 mm for 0-28-617 - 1 piece/card	X	5		
0-28-619	Glass scraper 64 mm [6]	X	6		
0-28-292	Replacement blade 64 mm for 0-28-619 - 1 piece/card	X	5		

PROFESSIONAL GLASS SCRAPER



- Metal holder with pull-out mechanism
- For removing paint, glue, stickers, etc. on glass
- Supplied with 1 Replacement blade
- Replacement blades 0-28-510 available separately

CODE	DESCRIPTION				PRICE
0-28-500	Professional Glass Scraper 95x40 mm	X	10		
0-28-510	Replacement blades for 0-28-500 10 pcs/card	X	10		
1-11-515	Replacement blades for 0-28-500 - Pack of 100	X	10	3253561115158	

WINDOW SCRAPER PLASTIC



- Yellow plastic handle with replaceable blade 1992 heavy duty
- For removing excess paint from windows

CODE	DESCRIPTION				PRICE
0-28-590	Window scraper Plastic 170x60 mm	X	12		

MULTI-TOOL

MULTI-TOOL 12-IN-1



- Combination plier, wire cutter, saw, pocket knife, large knife, bottle opener, screwdriver 3mm / 6mm / 8mm / PH1, file
- With pouch
- Stainless steel
- Length (closed) 105 mm
- Length (open) 165mm

CODE	DESCRIPTION				PRICE
0-84-519	Multi-tool 12 in 1	X	5		

FOLDING LOCKING MULTI-TOOL 14-IN-1



- Patented Locking Mechanism - to lock the tools
- Hassle Free and Secure Tool Selection
- Compact & foldable design
- Bit holder lockable at 90°, 135° and 180°
- Multi-tool supplied with knife, saw, file, bottle opener, 10, 11, 12 & 13 mm sockets and 6 screw bits

CODE	DESCRIPTION				PRICE
STHT0-70695	Multi-tool 14 in 1	X	6		

FATMAX® MULTITOOL T16

STANLEY
FATMAX



- Compact multi-tool with soft ergonomic handle for better grip
- Sturdy, black, oxidized finish for added durability
- Easy to open
- Contains 16 tools: needle nose and regular spring pliers, spring nippers, regular and serrated blades, scissors, wood/metal file, stripping pliers, 4x screwdrivers, unfolding carabiner, ruler, bottle and can opener

CODE	DESCRIPTION				PRICE
FMHT0-72414	FATMAX Multi Tool T16	-	24		

SCISSORS & GLAS CUTTERS

HEAVY-DUTY SCISSORS



- Titanium coating for longer life
- Bi-material handle for greater comfort
- Full tang once piece design - for long life
- Spring mechanism for easy opening

CODE	DESCRIPTION				PRICE
STHT0-14103	Heavy-duty scissors	X	6		

SCISSORS



- Serrated blade holds material in place and gives nice clean cut
- Stainless steel blade for long life
- Ergonomic handle for extra ease of use
- Suitable for: Twine, heavy fabric, strapping and other heavy duty materials

CODE	DESCRIPTION				PRICE
STHT0-14102	scissors	X	6		

GLAS CUTTER



- 6 steel wheels
- Traditional glass cutter
- Varnished wooden handle

CODE	DESCRIPTION				PRICE
0-14-040	Glass cutter	X	6	3253560140403	

INSULATING KNIFE

FATMAX® INSULATION CUTTING KNIFE 350MM

STANLEY
FATMAX

- Durable stainless steel blade
- Bi-material handle for improved comfort and grip
- Tether ready attachment point
- 50mm twin-edge blade stainless steel blade
- Fine cutting edge for cavity insulation and high density foam block
- Coarse teeth suitable for insulation wool"



CODE	DESCRIPTION				PRICE
FMHT0-10327	FATMAX Insulation cutting knife 350 mm	X	4	3 253560 103279	
FMHT10327-1	FATMAX Insulation cutting knife 350 mm with sheath	X	4	3253561103278	





MEASURING & LAYOUT TOOLS

Precision, our mission since 1854.

Since 1843 STANLEY® tools have been on the belt and in the hands of professional contractors and accomplished homeowners. Synonymous with quality, reliability, innovation, and value, STANLEY is the first name in tape measures and trusted worldwide for accuracy and dependability.

STANLEY® tape measures, levels and layout tools deliver the features needed for fast & accurate measurements.



PERFORMANCE YOU CAN MEASURE

This tape measure is the strongest and most compact tape from STANLEY. Our patented twin-core™ technology provides stand-out of 4m - a tape in a compact body with a convenient design.

THE IMPORTANCE OF THE END HOOK

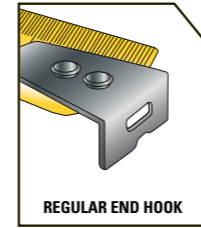

REGULAR END HOOK

REGULAR END HOOK

Extendable end hook with true zero position for accurate internal and external measurements.

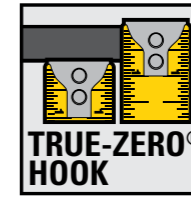

TRUE-ZERO HOOK®



VERSATILE END HOOK

VERSATILE END HOOK

Slightly larger than a regular end hook, sticking out on all edges. A versatile end hook, easily grabs behind building materials from the top, bottom and sides, allowing for easy measurement.

SPECIAL END HOOKS



DETACHABLE END HOOK

DETACHABLE END HOOK

Some jobs require a small and precise hook, while others require a large versatile hook. The detachable hook offers all possibilities.

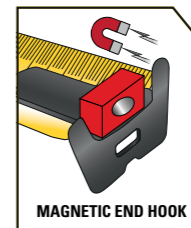

MAGNETIC END HOOK

MAGNETIC END HOOK

Useful when measuring metal objects.





Control the speed of the rewind and make sure that the blade does not bend to avoid uncontrolled movements

UNDERSTANDING THE BLADE – BLADE WIDTHS & MARKINGS

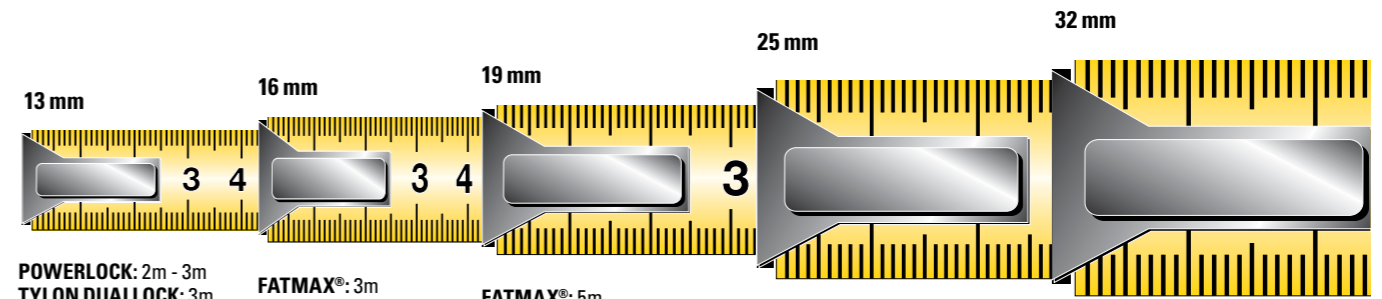

- 13 mm:** POWERLOCK: 2m - 3m, TYLON DUALLOCK: 3m, STANLEY: 3m
- 16 mm:** FATMAX®: 3m
- 19 mm:** FATMAX®: 5m, POWERLOCK: 5m, BOVENINKIJKVENSTER: 3m, STANLEY MAX: 3m, TYLON DUALLOCK: 5m, TYLON: 5m, STANLEY MAX: 3m
- 25 mm:** POWERLOCK BladeArmor®: 5m - 8m - 10m, POWERLOCK: 5m - 8m - 10m, STANLEY MAX: 5m - 8m, TYLON DUALLOCK: 8m, TYLON: 8m, STANLEY: 8m
- 32 mm:** FATMAX® NGT: 5m - 8m - 10m, FATMAX® PRO: 5m - 8m - 10m, FATMAX® PRO AUTOLOCK: 5m - 8m, FATMAX® BladeArmor®: 5m - 8m - 10m

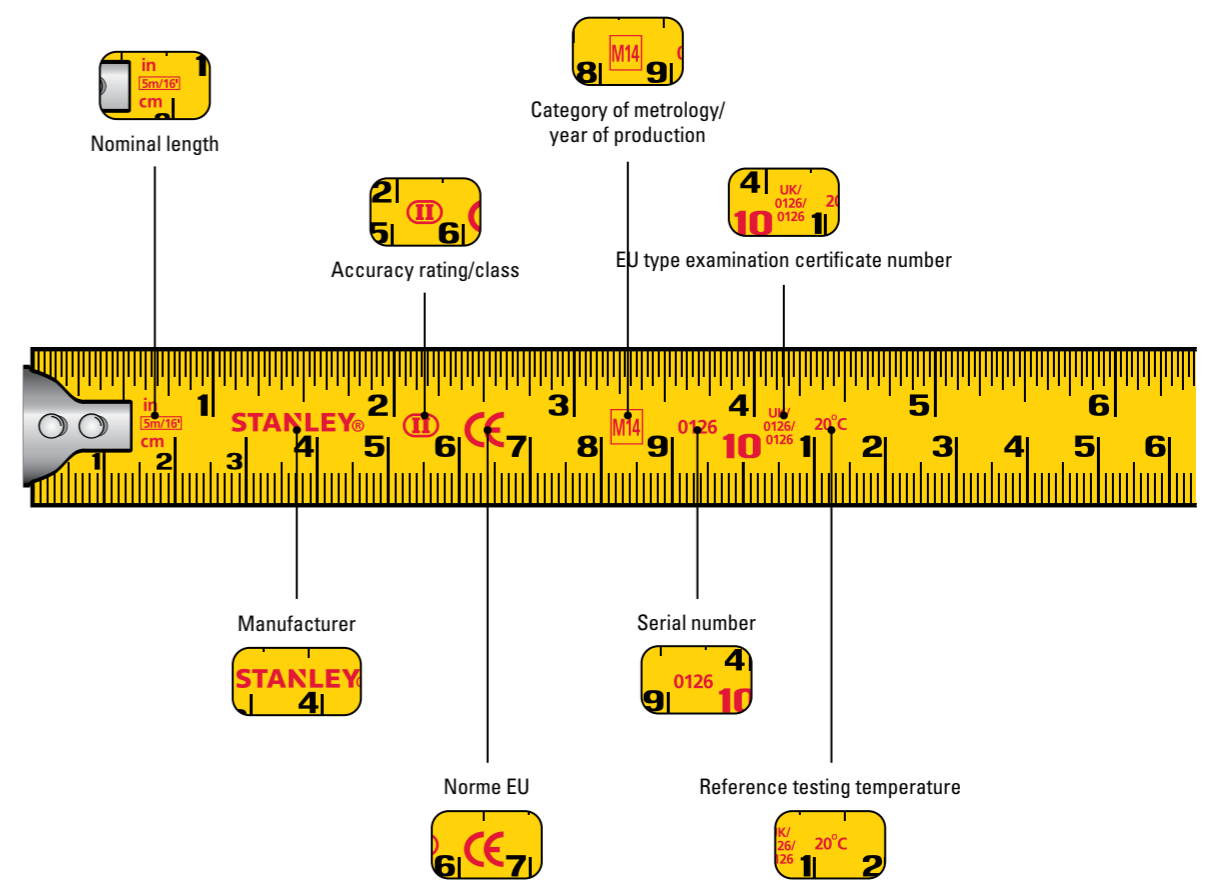

EUROPEAN STANDARDS FOR ACCURACY

ALLOWED TOLERANCES

Accuracy class	1m	2m	3m	5m	8m	10m
II	0,5mm	0,7mm	0,9mm	1,3mm	1,9mm	2,3mm
III	1mm	1,4mm				

All STANLEY tape measures sold in the Nordics meet European accuracy standards.

Example: for a class II tape measure of 3m, the tolerance is 0.9 mm over the entire length.

TYPE	COATING	WIDTH	EXTRA
FATMAX® PRO Next Generation 2.0	MAX SHIELD BLADE COATING Blade Armor™	32mm	DOUBLE-SIDED PRINT 4.9m REACH*
FATMAX® PRO AUTOLOCK	MYLAR® Blade Armor™	32mm	AUTO-LOCK BLADE
FATMAX® BLADEARMOR®	MYLAR® Blade Armor™	32mm	
STANLEY CONTROL-LOCK	MYLAR® Blade Armor™	19 - 25mm	AUTO-LOCK BLADE *EXCEPT 3M
STANLEY POWERLOCK	MYLAR® Blade Armor™	13 - 19 - 25mm	
STANLEY TYLON®	TYLON™	13 - 19 - 25mm	
STANLEY	TYLON™	13 - 19 - 25mm	

DURABILITY / COATING



Up to 1.5x more resistance to abrasion vs a standard coating



10x more resistance against abrasion vs a standard coating



20x more resistance against abrasion vs a standard coating



First 14 cm extra protection with thermoplastic layer reduces the risk of breaking with 95%

SHORT TAPE MEASURES WITH THUMB LOCK

FATMAX® PRO NG 2.0 TAPE MEASURE 32 MM

STANLEY
FATMAX

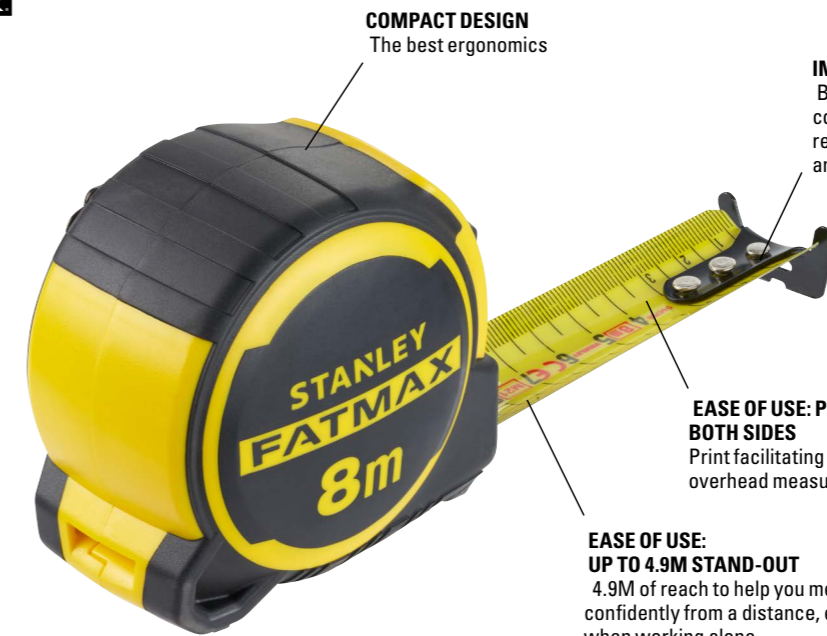
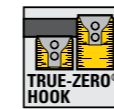

COMPACT DESIGN
The best ergonomics

IMPROVED BLADE DURABILITY
Built to last with an abrasion-resistant blade coating plus 20cm BladeArmor® coating to reinforce the most vulnerable part of the blade and reduce the risk of kinks or tears.

EASE OF USE: PRINTED ON BOTH SIDES
Print facilitating awkward or overhead measurements.

EASE OF USE: UP TO 4.9M STAND-OUT
4.9M of reach to help you measure confidently from a distance, even when working alone.

CODE	DESCRIPTION				PRICE
FMHT33100-0	FATMAX Pro NG 2.0 Tape measure 5m - 32mm printed on both sides	X	6	3 253560 331009	
FMHT33102-0	FATMAX Pro NG 2.0 Tape measure 8m - 32mm printed on both sides	X	6	3 253560 331023	

FATMAX® PRO TAPE MEASURE AUTOLOCK

STANLEY
FATMAX

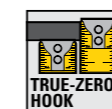

- Can be easily secured to a belt, pocket or waistband using the integral belt clip.
- Comfortable and robust bi-material housing
- BladeArmor coating on the first 80mm to double the lifespan
- Mylar® coated tape - up to 10 times more resistant to abrasion than standard tape measures
- Detachable magnetic hook included for added convenience when measuring metallic objects.
- This versatile tape comes complete with a multi-catch hook, detachable oversized multi-catch hook and removable magnetic hook
- CLASS II accuracy, suitable for most professionals, providing a reassuring +/-0.5mm error tolerance at 1m.

CODE	DESCRIPTION				PRICE
XTHT0-33671	Tape measure FATMAX Pro Autolock 5m - 32 mm	X	6	3 253560 336714	
XTHT0-33501	Tape measure FATMAX Pro Autolock 8m - 32 mm	X	6	3 253560 335014	

FATMAX® TAPE MEASURE BLADEARMOR™ MAGNETIC

**STANLEY
FATMAX**



- Patented bi-material housing for durability and comfort
- Clearly readable 32 mm blade
- Mylar® protective layer on the entire belt length and BladeArmor™ on the first 150 mm for longer life
- Patented magnet position for 100% accuracy
- Magnetic end hook with patented Multi-Catch Design
- Accuracy: Class II

CODE	DESCRIPTION				PRICE
FMHT0-33864	FATMAX Tape measure BA Magnetic 5m - 32 mm	X	4	2 5 3 5 6 0 1 3 3 8 6 4 0	
FMHT0-33868	FATMAX Tape measure BA Magnetic 8m - 32 mm	X	4	2 5 3 5 6 0 1 3 3 8 6 8 8	

FATMAX® TAPE MEASURE BLADEARMOR™

**STANLEY
FATMAX**



- Compact case design is Ergonomically shaped with a cushioned grip for maximum comfort in the hand and to use
- Mylar™ blade coating provides greater durability and wear resistance of blade markings for improved readability over time and prolonged product life
- First 14cm covered with BladeArmor™ - reduces risk of tire breakage by 95%
- The blade can extend 3.35m horizontally without kinking
- TRU-ZERO™ hook for precise inner and outer measurements
- Multi-functional hook: on top and bottom of measuring tape
- Shockproof cushion for protection of hook during belt return
- Belp clip
- Accuracy: Class II
- Double sided

CODE	DESCRIPTION				PRICE
0-33-720	FATMAX Tape measure BladeArmor 5m - 32 mm	X	4	2 5 3 5 6 0 1 3 3 7 2 0 9	
0-33-728	FATMAX Tape measure BladeArmor 8m - 32 mm	X	4	2 5 3 5 6 0 1 3 3 7 2 8 5	
0-33-811	FATMAX Tape measure BladeArmor 10m - 32 mm	X	4	2 5 3 5 6 0 1 3 3 8 1 1 4	

FATMAX® TAPE MEASURE 2M KEYCHAIN

**STANLEY
FATMAX**

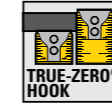

- Tylon™ blade coating for improved durability and wear resistance versus a standard lacquered blade.
- Small, compact and lightweight design 90cm standout
- TRU-ZERO™ hook for precise inner and outer measurements, moving back and forth along the securing rivets to account for the hook thickness.

CODE	DESCRIPTION				PRICE
FMHT1-33856	FATMAX Tape Measure 2m Keychain Display × 36	-	36	2 5 3 5 6 1 1 3 3 7 0 6 2	
FMHT0-33856	FATMAX Tape Measure 2m Keychain	X	6	2 5 3 5 6 0 1 3 3 8 5 6 5	

TAPE MEASURE CONTROL-LOCK

- The tape is equipped with an integrated finger brake, providing users with maximum control, except STHT37230-0
- Double-sided printing for top and bottom measurements
- Compact, light and ergonomic design
- First 8cm treated with BladeArmor® coating
- Versatile hook with true zero position for accurate internal and external measurements
- Removable magnet for use on metal surfaces, except STHT37230-0



CODE	DESCRIPTION				PRICE
STHT37230-0	Tape measure Control-Lock 3m - 19mm	X	4	2 5 3 5 6 0 1 3 7 2 3 0 9	
STHT37231-0	Tape measure Control-Lock 5m - 25mm	X	4	2 5 3 5 6 0 1 3 7 2 3 1 6	
STHT37232-0	Tape measure Control-Lock 8m - 25mm	X	4	2 5 3 5 6 0 1 3 7 2 3 2 3	
STHT37233-0	Tape measure Control-Lock 10m - 25mm	X	4	2 5 3 5 6 0 1 3 7 2 3 3 0	

TAPE MEASURE POWERLOCK® BLADEARMOR™

- Chrome-plated housing made of shock-resistant ABS
- Compact Ergo House- 12% smaller than traditional tape measures
- BladeArmor™ tape lasts 2x longer – 95% less likely to break
- Hook attached with 3 rivets, reduces risk of breakage if used carelessly - 40% stronger than attachment with 2 rivets
- Sliding hook with true zero - for accurate internal and external measurements
- Belt clip
- Accuracy: Class II

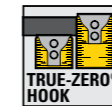

CODE	DESCRIPTION				PRICE
0-33-514	Tape measure Powerlock BladeArmor 5m - 25 mm	X	4	2 5 3 5 6 0 1 3 3 5 1 4 4	
0-33-527	Tape measure Powerlock BladeArmor 8m - 25 mm	X	4	2 5 3 5 6 0 1 3 3 5 2 7 4	

TAPE MEASURE POWERLOCK® CLASSIC



- Chromed housing
- Mylar™ blade coating provides greater durability and wear resistance of blade markings for improved readability over time and prolonged product life
- TRU-ZERO™ hook for precise inner and outer measurements
- Belt lock button
- Belt clip
- Accuracy: Class II

CODE	DESCRIPTION	✉	✕	📊	PRICE
0-33-218	Tape measure Powerlock 3m - 12.7 mm metal	X	6	3 253560 332181	
1-33-218	Tape measure Powerlock 3m - 12.7 mm metal	-	12	3 253561 332180	

TAPE MEASURE POWERLOCK® ABS M/FT

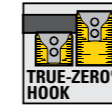

- Chrome-plated housing made of shock-resistant ABS
- Mylar™ blade coating provides greater durability and wear resistance of blade markings for improved readability over time and prolonged product life
- Hook fixed with 2 rivets (3 rivets from 5m) on metal plate, reduces the risk of breaking in case of careless use
- TRU-ZERO™ hook for precise inner and outer measurements
- Accuracy: Class II
- Belt lock button
- Belt clip

CODE	DESCRIPTION	✉	✕	📊	PRICE
0-33-158	Tape Measure Powerlock 5m/16' - 19mm	X	6	3 253560 331580	

TAPE MEASURE POWERLOCK® ABS



- Chrome-plated housing made of shock-resistant ABS
- Tape with Mylar® coating: up to 10x more protected against wear than traditional measuring tapes
- Hook fixed with 2 rivets (3 rivets from 5m) , reduces the risk of breaking
- TRU-ZERO™ hook for precise inner and outer measurements
- Belt clip
- Accuracy: Class II

CODE	DESCRIPTION	✉	✕	📊	PRICE
0-33-194	Tape Measure Powerlock 5m - 19mm	X	6	3 253560 331948	
1-33-194	Tape Measure Powerlock 5m - 19mm	-	18	3 253561 331947	
0-33-195	Tape measure Powerlock 5m - 25 mm	X	4	3 253560 331955	
0-33-198	Tape measure Powerlock 8m - 25 mm	X	4	3 253560 331986	
1-33-198	Tape measure Powerlock 8m - 25 mm	-	12	3 253561 331985	
0-33-442	Tape measure Powerlock 10m - 25 mm	X	4	3 253560 334420	
1-33-442	Tape measure Powerlock 10m - 25 mm	-	12	3 253561 334429	

TAPE MEASURE POWERLOCK® TOP VIEWING WINDOW

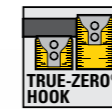

- Top viewing window: this makes it easy and accurate to measure inside dimensions
- Chrome-plated housing made of shock-resistant ABS
- Mylar™ blade coating provides greater durability and wear resistance of blade markings for improved readability over time and prolonged product life
- Hook fixed with 3 rivets, reduces risk of breakage in case of careless use - 40% stronger than fastening with 2 rivets
- TTRU-ZERO™ hook for precise inner and outer measurements
- Belt lock button
- Belt clip
- Accuracy: Class II
- Double sided

CODE	DESCRIPTION	✉	✕	📊	PRICE
0-33-932	Tape measure Powerlock 5m - 19mm top viewing window	X	6	3 253560 339326	

STANLEY® FATMAX® XTREME™ TAPE MEASURE - 32 MM



- Coated blade - provides up to 10 times more resistance to abrasion than a standard lacquered blade, increasing the life of the tape and reducing wear on most heavily used sections of the blade.
- BLADEARMOR® COATING reinforces the first 7.5cm of the blade, the section most vulnerable to wear
- TRU-ZERO™ HOOK for precise inner and outer measurements
- Large, protruding oversized multi-catch hook
- Belt clip
- Accuracy: Class II

CODE	DESCRIPTION	✉	✕	📊	PRICE
0-33-887	STANLEY® FATMAX® Xtreme™ 5M Tape Measure	X	6	3253560338879	
0-33-892	STANLEY® FATMAX® Xtreme™ 8M Tape Measure	X	6	3253560338923	
0-33-897	STANLEY® FATMAX® Xtreme™ 10M Tape Measure	X	6	3253560338978	

TAPE MEASURE TYLON DUAL-LOCK



- Innovative Dual lock mechanism, combines automatic blade locking with classic blade locking
- Soft grip for maximum comfort during use
- Shockproof housing for increased protection of the blade and mechanism
- New Tylon protective layer, 1.75x more resistant to abrasion: improved readability and longer life
- Matt, non-reflective finish of the blade prevents reflection of (sun)light
- Clearly legible digits for fast and accurate measurements
- End hook secured to the blade with 2 or 3 pop rivets for increased strength and durability
- Handy help clip to store the tape measure quickly and at hand
- Accuracy: Class II

CODE	DESCRIPTION	☐	☒	☐	PRICE
STHT36802-0	Tape measure Tylon Duallock 3m - 13 mm	X	6	3 253560 368029	
STHT36803-0	Tape measure Tylon Duallock 5m - 19 mm	X	6	3 253560 368036	
STHT36804-0	Tape measure Tylon Duallock 8m - 25 mm	X	6	3 253560 368043	

TAPE MEASURE TYLON™ M/FT

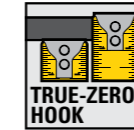

- Innovative and ergonomic design: light and compact measuring tape
- Soft grip for maximum comfort during use
- Shockproof housing for increased protection of the belt and mechanism
- New Tylon protective layer, 1.5x more resistant to abrasion: improved readability and longer life
- Matt, non-reflective finish of the band prevents reflection of (sun)light
- Clearly legible digits for fast and accurate measurements
- Manual locking system
- End hook secured to the blade with 2 or 3 pop rivets for increased strength and durability
- Handy belt clip to store the tape measure quickly and at hand
- Accuracy: Class II

CODE	DESCRIPTION	☐	☒	☐	PRICE
0-30-686	Tape Measure Tylon - 3m/10'; - 12.7mm	X	6	3 253560 306861	
0-30-696	Tape Measure Tylon - 5m/16'; - 19mm	X	6	3 253560 306960	
0-30-656	Tape Measure Tylon - 8m/24'; - 25mm	X	36	3 253560 306564	

TAPE MEASURE TYLON™

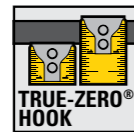

- Innovative and ergonomic design: light and compact measuring tape
- Soft grip for maximum comfort during use
- Shockproof housing for increased protection of the belt and mechanism
- New Tylon protective layer, 1.5x more resistant to abrasion: improved readability and longer life
- Matt, non-reflective finish of the band prevents reflection of (sun)light
- Clearly legible digits for fast and accurate measurements
- Manual locking system
- End hook secured to the blade with 2 or 3 pop rivets for increased strength and durability
- Handy belt clip to store the tape measure quickly and at hand
- Accuracy: Class II

CODE	DESCRIPTION	☐	☒	☐	PRICE
0-30-687	Tape Measure Tylon 3m - 12.7mm	X	6	3 253560 306878	
1-30-687	Tape Measure Tylon 3m - 12.7mm	-	12	3 253561 306877	
0-30-697	Tape Measure Tylon 5m - 19mm	X	6	3 253560 306977	
1-30-696	Tape Measure Tylon 5m/16' - 19mm - Bulk tray			12 3253561306969	
1-30-697	Tape Measure Tylon 5m - 19mm	-	12	3 253561 306976	
0-30-657	Tape Measure Tylon 8m - 25mm	X	6	3 253560 306571	
1-30-657	Tape Measure Tylon 8m - 25mm	-	12	3 253561 306570	

TAPE MEASURE

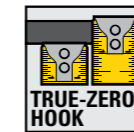

- Polymer protective layer and sturdy ABS housing
- Clearly readable
- Chromed belt clip
- Ergonomic design with strap lock button
- TRU-ZERO™ hook for precise inner and outer measurements.

CODE	DESCRIPTION	☐	☒	☐	PRICE
0-30-487	Tape measure 3m - 12.7mm	X	6	3 253560 304874	
1-30-487	Tape measure 3m - 12.7mm	-	12	3 253561 304873	
0-30-497	Tape measure 5m - 19mm	X	6	3 253560 304973	
1-30-497	Tape measure 5m - 19mm	-	12	3 253561 304972	
0-30-457	Tape measure 8m - 25mm	X	6	3 253560 304577	

SHORT TAPE MEASURES WITHOUT THUMB LOCK

TAPE MEASURE PLA



- Pocket tape measure: extra flat housing
- Shockproof ABS housing
- Automatic tape return
- Accuracy: Class II

CODE	DESCRIPTION				PRICE
0-32-100	Tape measure Pla 3m - 6.35 mm	X	12		

TAPE MEASURE PANORAMIC



- Shockproof ABS housing
- Protective aluminum base plate
- Hardened and tempered carbon steel measuring tape covered with Mabolon™ polyamide protective coating - abrasion resistant, resistant to chemicals and virtually unbreakable
- Top viewing window: this makes it easy and accurate to measure inside dimensions
- TRU-ZERO™ hook for precise inner and outer measurements.
- Automatic tape return
- Accuracy: Class II

CODE	DESCRIPTION				PRICE
0-32-125	Tape measure Panoramic 3m - 12.7 mm	X	6		

FOLDING RULERS - FOLDING RULERS

FOLDING RULER WOOD



- Multi layered finish
- Weatherproof top layer with UV coating
- Copper fittings
- Hidden rivets and steel coil springs

CODE	DESCRIPTION				PRICE
0-35-455	Folding rule 2m - 15 mm wood	X	10		

FOLDING RULER WOOD - YELLOW/WHITE



- Multi layered finish
- Weather resistant top layer with UV coating
- Copper fittings
- Hidden rivets and steel coil springs

CODE	DESCRIPTION				PRICE
0-35-458	Folding Ruler 2m - 15 mm Yellow/White	X	10		

FOLDING RULER PLASTIC

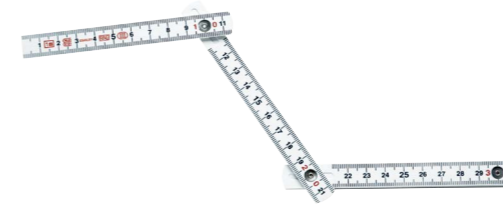

- Fiberglass ruler
- Deep engraving
- Red decimal numbers
- Hollow rivets and double coil springs

CODE	DESCRIPTION				PRICE
0-35-229	Folding ruler 2m plastic	X	10		

YARDSTICK FLEXIBLE



- Engineer's Yardstick, stainless steel with photographically etched tick marks
- Markings of 1 mm on the front and 0.5 mm on the back
- Non-reflective surface makes reading easy
- Accuracy: Class II

CODE	DESCRIPTION				PRICE
1-35-524	Yardstick 300 mm - 13 mm	-	10		
1-35-536	Yardstick 500 mm - 19 mm	-	10		

THE MEASURE OF A PRO™

LONG TAPES



3 TYPES OF HOUSING



OPEN HOUSING
Ergonomic
Easy to maintain



HALF CLOSED HOUSING
Compact
Easy to maintain



CLOSED HOUSING
Compact
Measuring tape is protected

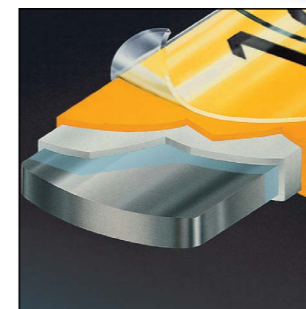

MABOLON LONG TAPES

Carbon steel ribbon, hardened and tempered MABOLON protective polyamide layer guarantees exceptional resistance to abrasion. Virtually unbreakable under normal use.

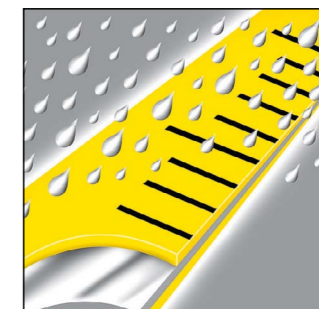

STAINLESS STEEL MEASURING TAPE

Available up to 9.5 mm wide. Resistant to abrasion, with maximum corrosion protection. anti-corrosion.

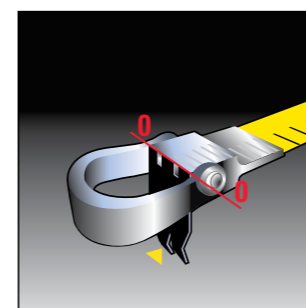

FOLDABLE END HOOK

Hardened steel hook opens to 90° with the zero point on the inside of the hook. Barbs provide a non-slip grip on most materials.

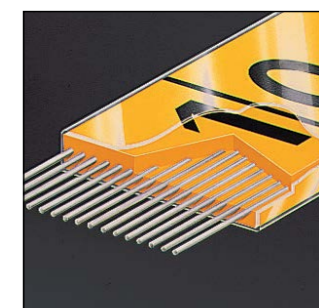

FIBERGLASS MEASURING TAPE

Fiberglass measuring tape, very resistant to stretching. Markings protected by a unique transparent coating. Smooth and washable. Does not conduct electricity.

FIBERGLASS MEASURING TAPE – GRADATION EVERY 2 MM



STAINLESS STEEL MEASURING TAPE – GRADE EVERY 1 MM



EUROPEAN STANDARDS FOR ACCURACY

ALLOWED TOLERANCES

Accuracy class	10m	20m	30m	50m	100m
II	2,1mm	4,3mm	6,3mm	10,3mm	20,3mm
III	4,6mm	8,6mm	12,6mm	20,6mm	40,6mm

All STANLEY tape measures sold in the Nordics are compliant to European accuracy standards.

Example: for a 20m class II long tape measure, the tolerance allowed is 4.3mm over the entire length.

LONG TAPES

LONG TAPE MASTER II



- Ergonomic moulded handle
- Open chrome-plated copper frame
- Tape and handle interchangeable for right handed or left handed users
- Large tape loop (DIN standard) equipped with a removable strap with a fully retractable catching pallet
- Yellow band color with 2 mm graduations for good legibility
- Accuracy: Class II

CODE	DESCRIPTION				PRICE
1-34-477	Long tape Master II 30m - 12.7mm	-	1	3 2535611344770	
1-34-478	Long tape Master II 50m - 12.7mm	-	1	3 2535611344787	

LONG TAPE ACIELAK



- Perforated Steel case covered with an epoxy lacquer that is highly resistant to shocks and corrosion
- Tangential tape exit for optimal tape return
- Chrome-plated folding steel crank (DIN standard) with folding hook
- Yellow band color with 2 mm graduations for good legibility
- Accuracy: Class II

CODE	DESCRIPTION				PRICE
0-34-406	Long tape ACIELAK 20m - 12.7mm	X	2	3 2535601344061	

FATMAX® LONG TAPE FIBERGLASS

STANLEY
FATMAX



- Fiberglass tape
- Handle bimaterial
- 3:1 ratio when winding
- Hook for anchoring
- Accuracy: Class II

CODE	DESCRIPTION				PRICE
2-34-824	FATMAX Long tape 60m - 19 mm - open case	X	2	3 2535621348241	

FATMAX® LONG TAPE

STANLEY
FATMAX



- Impact resistant enclosed ABS housing with soft elastomer for comfortable grip
- Stainless steel strap
- 3.1 ratio when winding
- Foldable handle
- Yellow band color with 1 mm graduations for good readability
- Accuracy: Class II

CODE	DESCRIPTION				PRICE
0-34-133	FATMAX Long tape 20m - 9.5 mm - closed case	X	6	3 2535601341336	
0-34-134	FATMAX Long tape 30m - 9.5 mm - closed box	X	6	3 2535601341343	

LONG TAPE CLOSED CABINET



- Shock-resistant yellow ABS housing for long life and optimal visibility
- Tempered carbon steel measuring tape with durable polymer protective coating
- Hook fits inside house for easy storage
- Foldable crank handle for easy storage
- Yellow strap color with clearly legible 1 mm graduations
- Accuracy: Class II

CODE	DESCRIPTION				PRICE
0-34-105	Long tape Steel 20m - 9.5 mm - closed case	X	6	3 2535601341053	
0-34-108	Long tape Steel 30m - 9.5 mm - closed case	X	6	3 2535601341084	

LONG TAPE POWERWINDER FIBERGLASS



- Fiberglass tape
- 3:1 ratio when wound up
- Transparent coating against wear
- End hook with "true zero";
- Hook for anchoring
- Shockproof ABS housing
- Accuracy: Class III

CODE	DESCRIPTION				PRICE
2-34-772	Long tape Powerwinder 30m - 12.7mm	X	2	3 2 5 3 5 6 2 1 3 4 7 7 2 5	
2-34-775	Long tape Powerwinder 60m - 12.7mm	X	2	3 2 5 3 5 6 2 1 3 4 7 7 5 6	
2-34-777	Long tape Powerwinder 100m - 12.7mm	X	2	3 2 5 3 5 6 2 1 3 4 7 7 7 0	

LONG TAPE FIBERGLASS



- ABS structure with high impact capacity for use in harsh working conditions
- Reinforced fiberglass tape with 40 strands: reduces elasticity and increases accuracy.
- Highly visible yellow tape with 2 mm graduations for precise measurements
- Tape: corrosion resistant, with UV protection, non-conductive and with a washable PVC coating for extra durability
- Includes large handle and a ground spike for even more accuracy
- Accuracy: Class III

CODE	DESCRIPTION				PRICE
2-34-792	Long tape Fiberglass 30m - 12.7 mm - open case	X	2	3 2 5 3 5 6 2 1 3 4 7 9 2 3	
2-34-795	Long tape Fiberglass 60m - 12.7 mm - open box	X	2	3 2 5 3 5 6 2 1 3 4 7 9 5 4	

LONG TAPE FIBERGLASS CLOSED CABINET



- ABS structure with high impact capacity for use in harsh working conditions
- Reinforced fiberglass tape - reduces elasticity and increases accuracy
- Highly visible yellow tape with 2 mm graduations for precise measurements
- Tape: corrosion resistant, with UV protection, non-conductive and with a washable PVC coating for extra durability
- Perforated at the back for easier cleaning of the tape
- Accuracy: Class III

CODE	DESCRIPTION				PRICE
0-34-295	Long tape Fiberglass 10m - 12.7mm closed box	X	6	3 2 5 3 5 6 0 1 3 4 2 9 5 1	
0-34-296	Long tape Fiberglass 20m - 12.7mm closed box	X	6	3 2 5 3 5 6 0 1 3 4 2 9 6 8	
0-34-297	Long tape Fiberglass 30m - 12.7mm closed box	X	6	3 2 5 3 5 6 0 1 3 4 2 9 7 5	

MEASURING WHEELS

MW40M COUNTER MEASURING WHEEL



- 5 digit counter with manual reset button for superb accuracy
- Sturdy folding handle with rubber grip
- Aluminum wheel with rubber tire
- Accuracy +/- 99%
- With carrying bag

CODE	DESCRIPTION				PRICE
1-77-174	MW40M COUNTER MEASURING WHEEL	-	6	3 2 5 3 5 6 1 1 7 7 1 7 4 3	

THE MEASURE OF A PRO™

PRACTICAL INFORMATION

OUR ASSORTMENT

MULTIUSE SQUARE

This is an important part in the carpenter's toolbox. Can be used as a try and mitre square, depth or height gauge and spirit level



SLIDING BEVEL

Intended for repeating and marking angles, but the bevel must be used in conjunction with a protractor if you want to set the bevel at a specific angle.



CARPENTERS FLAT STEEL SQUARE

A very useful tool if you often need to mark large panels. Reverse reading scale and crisply embossed graduations for easy reading



MARKING GAUGE

Used for scoring lines along the length of a piece of wood parallel to the top or top edge. It is more accurate to cut or plan along a scored line than along a pen line. The marking gauge consists of a baffle plate that rubs against the top or top edge of the work and a graduated bar that contains a hardened notching pin. The spacing of the pin and striker plate is set with a steel gauge bar and the bar is locked in position with a thumbscrew.



FOLDING SQUARE

Indispensable for the large-scale layout of building profiles, foundations, tiling, paving, driveway construction and landscaping. The simple folding system makes it compact and easy to carry.



CHALK LINE

Used for marking straight lines on the floor, wall or ceiling. It is an important part in the toolbox of contractors and plumbers for the layout of walls, floors etc.



MARKING OUT TOOLS

STANLEY® DIGITAL ANGLE LEVEL - 40CM



- Digital angle level with illuminated LCD screen
- Measurements from 0° to 225°
- 2 vials: 1 horizontal and 1 vertical
- Aluminium profile
- Accuracy in digital measurements: 0.1°
- Supplied with 2x AAA batteries
- Supplied with waterproof bag
- 360° readability - text on screen rotates with the device
- HOLD function
- Memory
- Calibration function
- Suitable for measuring double miter angles (via memory function)

CODE	DESCRIPTION	✉	☒	📊	PRICE
0-42-087	STANLEY® DIGITAL ANGLE LEVEL - 40CM	X	4	3 253560420871	

JOINERS BEVEL 5025



- Extendable Joiners' Bevel
- Impact-resistant plastic bar with precision-finished surface
- Plastic beam with hardened and blued steel blade
- Chromed locking knob

CODE	DESCRIPTION	✉	☒	📊	PRICE
0-46-529	Swivel hook 5025 - 228 mm	X	6	3 253560465292	
0-46-535	Swivel hook 5025 - 267 mm	X	6	3 253560465353	

PLASTIC JOINERS BEVEL H1225



- Extendable Joiners' Bevel
- Plastic bar with built-in handles
- Stainless hardened steel blade
- Locking knob with wing nut

CODE	DESCRIPTION	✉	☒	📊	PRICE
0-46-825	Swivel hook H1225 - 200 mm	X	6	3 253560468255	9.00

COMBINATION SQUARE



- Light plastic body
- Etched sheet metal, durable and easy to read
- Built-in level
- Graduation in mm
- Functions: square and miter, depth or height gauge, and level

CODE	DESCRIPTION	✉	☒	📊	PRICE
2-46-017	Combination Square 300 mm	X	6	3 253562460172	

CARPENTER'S TRY/MITRE SQUARE

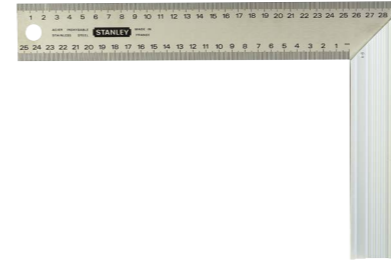

- Printed graduation in mm on stainless steel, clearly visible
- Ribbed aluminum bar with 3 rivets attached to square for strength and accuracy
- Th beam is chamfered to make 90° and 45° angles
- mm division on both sides

CODE	DESCRIPTION	✉	☒	📊	PRICE
1-45-685	Square 250 x 140 mm	-	6	3 253561456855	
1-45-686	Square 300 x 200 mm	-	6	3 253561456862	
1-45-687	Square 400 x 200 mm	-	6	3 253561456879	

STEEL SQUARE



- Square metric with crisply embossed graduations for easy reading
- Steel square with buffed finish and protective lacquer coating for rust resistance
- Face graduated every 2mm, reverse of blade every 1/8" th for detailed work
- Not supplied with data books

CODE	DESCRIPTION	✉	☒	📊	PRICE
1-45-530	Steel Square 600 x 400 mm	-	6	3 253561455308	

FOLDING BUILDER'S SQUARE



- Foldable construction square
- Durable, lightweight aluminum design
- Angles of 90° and 45°
- Equipped with suspension hole for vertical storage

CODE	DESCRIPTION	✉	☒	📊	PRICE
1-45-013	Foldable construction hook Aluminum 1720 x 1220 mm	-	1	3 253561450136	

METRIC DIECAST COMBINATION SQUARE



- Durably etched, hard-chrome-plated blades are rust resistant
- 300 mm square has precision-machined working surfaces for improved accuracy
- Built-in scriber comes in handy for surface marking
- Precision die cast body with 3 precision machined faces for accuracy

CODE	DESCRIPTION	✉	☒	📊	PRICE
2-46-028	Met Diecast Comb Square 300 mm	X	4	3253562460288	

COMBINATION SQUARE



- Blade etched with imperial/metric graduations in mm & cm and inch and 1/8" and 1/16"
- Can be used as a try and mitre square, depth or height gauge and spirit level
- Cast iron professional combination square for accuracy & long life
- Class I accuracy
- Machined on all faces for accuracy

CODE	DESCRIPTION	✉	☒	📊	PRICE
0-46-151	Combination Square - 300 mm	X	4	3253560461515	

CHALK LINE REELS

STANLEY® FATMAX® 30 M XTREME™ CHALK LINE

**STANLEY
FATMAX**



- Chalkview™ housing with see-through powder container
- Durable aluminum housing with steel hook, belt clip and twist handle
- Easy to handle: the line is extracted effortlessly without using the handle
- On-board hook storage for convenience
- Pivoting handle locks into housing to hold back line cord
- Powder container: 45g
- Contains 30m of polyester/nylon cord
- Specially designed hook grabs on side, top or bottom for versatility
- Quick release system

CODE	DESCRIPTION				PRICE
0-47-480	FATMAX Pro Chalk Line Reel 30m	X	6	3 253560 474805	
0-47-488	FATMAX Pro Chalk Line Reel 30m - with black powder	X	6	3253560474881	

CHALK LINE



- Aluminum housing with folding handle
- Chalk line (replaceable): length: 30m, diameter: 1 mm
- Can be used vertically as a plumb bob
- The line is blocked by folding the handle
- 30g chalk capacity

CODE	DESCRIPTION				PRICE
0-47-100	Chalk line mill 30m	X	6	3 253560 471002	

STANLEY® FATMAX® 30 M CHALK LINE KIT

**STANLEY
FATMAX**



- 0-47-140 FATMAX® Chalk Line Reel 30m
- 1-47-403 115g chalk line powder
- 0-47-316 STANLEY® Fine Marker Pen

CODE	DESCRIPTION				PRICE
0-47-681	STANLEY® FATMAX® 30 m Chalk Line Kit	X	6	3 253560 476816	

CHALK LINE REEL POWERWINDER



- 3.5 x faster - Quick Gear Release
- Steel rotary handle
- Transparent powder container
- On-Board Hook Storage
- Sliding door for quick and easy refill
- Can also be used as a plumb bob
- High Impact ABS Case

CODE	DESCRIPTION				PRICE
0-47-460	Chalk line reel Powerwinder 30m	X	6	3 253560 474607	

CHALKING LINE KIT POWERWINDER



- 0-47-460 Battle Line Reel Powerwinder 30m
- 1-47-403 115gr chalk line powder
- 0-42-287 Line spirit level

CODE	DESCRIPTION				PRICE
0-47-465	Chalk line kit Powerwinder 30m	X	5	3 253560 474652	

ABS CHALK LINE REEL



- Shockproof ABS housing
- Foldable rotary handle
- Sliding door for refilling powder
- Stainless steel hook

CODE	DESCRIPTION				PRICE
0-47-440	ABS Chalk Line Reel 30m	X	6	3 253560 474409	

ABS CHALK LINE KIT



- 0-47-440 Chalk Line STANLEY® ABS
- 1-42-403 115gr chalk line powder
- 0-42-287 Line spirit level

CODE	DESCRIPTION				PRICE
0-47-443	ABS Chalk Line Kit 30m	X	5	3 253560 474430	

* Photo for illustrative purposes only

COMPACT CHALK LINE REEL 9M



- Less than half the volume of a standard chalk line for easier carrying and storage
- 9m precision line displays clear, accurate lines
- High-impact ABS housing with soft grip layer for extra durability, comfort and a secure grip
- 3:1 rewind speed pulls the line 3x faster than standard 1:1 chalk line reels
- Slide door for a quick refill of chalk
- 28gr chalk capacity gives 50 lines per refill
- Includes belt clip for convenient transportation

CODE	DESCRIPTION				PRICE
STHT0-47147	Compact Chalk Line Reel 9m	X	6	3 253560 471477	
STHT0-47244	Compact Chalk Line Reel Kit 9m	X	6	3 253560 472443	

REPLACEMENT CHALK LINE



- 30m reserve line: diameter: 1 mm
- For all models except Traçor (0-01-000)

CODE	DESCRIPTION				PRICE
0-47-101	REPLACEMENT CHALK LINE 30m	X	6		

FATMAX® PRO CHALK LINE POWDER

STANLEY
FATMAX



- Suitable for use in a humid environment
- Water resistant
- More accurate & durable than traditional chalk line powder
- Up to 75% less waste
- Available in red and black powder
- Class 3 (visibility ±4 months)

CODE	DESCRIPTION				PRICE
9-47-822	FATMAX Pro Chalk Line Powder - Black	-	18		
9-47-821	FATMAX Pro Chalking Line Powder - Red	-	18		

CHALK LINE POWDER



- Special powder – for good adhesion and visibility
- Water-resistant
- White: indoor use; for example floor covering - Class 1 (visibility ±1 week)
- Blue: for general work both indoors and outdoors - Class 1 (visibility ±1 week)
- Red: for masonry, outside. Non-removable - Class 3 (visibility ±2 months)

CODE	DESCRIPTION				PRICE
1-47-403	Chalk line powder Blue 115gr	-	12		
1-47-404	Chalk line powder Red 115gr	-	12		
1-47-803	Chalk line powder Blue 225gr	-	12		
1-47-804	Chalk line powder Red 225gr	-	12		
1-47-917	Chalk line powder Blue 1000gr	-	6		
1-47-919	Chalk line powder Red 1000gr	-	6		

* Photo for illustrative purposes only

MARKERS AND PENCILS

BLACK TIP MARKER

STANLEY
FATMAX



- Permanent ink makes it ideal to mark out in all weather/conditions
- Strong, durable tip reduces wear - bevel angle
- Suitable for industrial applications
- Use on concrete, roofing material, nuts & bolts, hand tools, wood & metal and pipes
- Available in black - 2 pcs/card
- Available in red, blue, black - 3 pcs/card (0-47-315)
- Beveled tip 0-47-314 & 0-47-315
- Fine tip 0-47-312

CODE	DESCRIPTION				PRICE
0-47-312	FATMAX Marker Black - fine tip (x2)	X	12		
0-47-314	FATMAX Marker Black (x2)	X	12		
0-47-315	FATMAX Marker Red/Black/Blue (x 3) Clipstrip	X	12		

MARKER FINE TIP



- Permanent black ink
- Water resistant
- Use on concrete, copper, nuts & bolts, hand tools, wood & metal, pipes

CODE	DESCRIPTION				PRICE
0-47-316	Marker Fine Tip Black	X	24		

MARKERS MINI



- Permanent, water-resistant ink
- Use on concrete, copper, nuts & bolts, hand tools, wood & metal and pipes
- Available in black (1-47-324)
- Available in red/green/blue (1-47-329)

CODE	DESCRIPTION				PRICE
1-47-324	Marker Mini Black (x 72)	-	72		
1-47-329	Marker Mini Red/Green/Blue (x 72)	-	72		



CODE	DESCRIPTION				PRICE
2-47-329	STANLEY® mini MULTI Fine Tip - Carder x 4 on clipstrip (Black/Red/Green/Blue)	-	48		

CARPENTER'S PENCIL



- Oval-shaped carpenter's pencil
- Rectangular HB graphite pencil

CODE	DESCRIPTION				PRICE
1-03-850	Pencil Red	-	60	3 253561 038501	

MARKING GAUGE



- Plastic marking Gauge
- Plastic stock with metal insert for abrasion resistance
- Calibrated plate for easy adjustment
- Graduation per 2 mm
- Total length 215mm

CODE	DESCRIPTION				PRICE
2-47-064	Marking Gauge 150 mm	X	5	3 253562 470645	



LEVELS

Around the jobsite, in your garage, or just for hanging pictures, you need a level tool you can count on to keep your project level and functional. We offer a wide selection of levels, including laser, I-beam, torpedo, box beam levels, and others.

LEVELS THE RIGHT LEVEL FOR THE JOB

The longer the better, particularly if the surface to be levelled is not perfectly true. A shorter level will tend to follow the contour of the surface, whereas a longer level will even out the undulations. For bricklaying and general builders the best choice is the 1200mm and for concreters the 1800mm would be a good choice. Finish carpenters may prefer a lighter box or I beam section body in a length of 600 or 900mm, ideal for fitting kitchen furniture and general trim work.



LEVELS

FATMAX® PRO I BEAM LEVELS

STANLEY
FATMAX

- Sturdy I-Beam profile up to 5× stronger than other STANLEY® Levels
- Extra large center vial for clear readability
- Block vials with excellent accuracy (0.5 mm/m)
- Bi-material handle bolted to the frame
- 2 work surfaces for maximum accuracy
- Rubber protection ends
- Lifetime accuracy guarantee



CODE	DESCRIPTION	✉	✕	📦	PRICE
0-43-616	FATMAX Pro Level 400mm	-	1	3 253560 436162	
0-43-624	FATMAX Pro Level 600mm	-	4	3 253560 436247	
0-43-636	FATMAX Pro Level 900mm	-	1	3 253560 436360	
0-43-648	FATMAX Pro Level 1200mm	-	1	3 253560 436483	
0-43-672	FATMAX Pro Level 1800mm	-	1	3 253560 436728	
0-43-681	FATMAX Pro Level 2000mm	-	1	3 253560 436810	

FATMAX® PRO I BEAM LEVEL 3-PACK

STANLEY
FATMAX

- 1 x 0-43-672 – 180cm FATMAX Box Beam Level
- 1 x 0-43-648 – 120cm FATMAX Box Beam Level
- 1 x 0-43-624 – 60cm FATMAX Box Beam Level
- 1 x 1-98-101 180cm Level Bag



CODE	DESCRIPTION	✉	✕	📦	PRICE
XTHT0-43119	FATMAX Pro Level 3-pack	-	1	3253560431198	

FATMAX® PRO I BEAM MAGNETIC LEVELS

STANLEY
FATMAX

- Sturdy I-beam profile up to 5× stronger than other STANLEY® Levels
- Extra large center vial for clear readability
- Block vials with excellent accuracy (0.5 mm/m)
- Bi-material handle bolted to the frame
- 2 work surfaces for maximum accuracy
- Built-in magnets 2× stronger than regular strip magnets
- Rubber protection ends
- Lifetime accuracy guarantee



CODE	DESCRIPTION	✉	✕	📦	PRICE
0-43-617	FATMAX Pro Magnetic Level 400 mm	-	1	3 253560 436179	
0-43-625	FATMAX Pro Magnetic Level 600 mm	-	4	3 253560 436254	
0-43-637	FATMAX Pro Magnetic Level 900 mm	-	1	3 253560 436377	
0-43-649	FATMAX Pro Magnetic Level 1200 mm	-	1	3 253560 436490	
0-43-679	FATMAX Pro Magnetic Level 2000 mm	-	1	3 253560 436797	

THE RIGHT LEVEL FOR THE JOB

SELECT THE RIGHT LENGTH OF LEVEL

The longer the better, particularly if the surface to be levelled is not perfectly true. A shorter level will tend to follow the contour of the surface, whereas a longer level will even out the undulations. For bricklaying and general builders the best choice is the 1200mm FatMax Xtreme and for concreters the 1800mm would be a good choice. Finish carpenters may prefer a lighter box or I beam section body in a length of 600 or 900mm, ideal for fitting kitchen furniture and general trim work.

BOX BEAM LEVELS

The box section provides the ultimate in terms of overall strength and performance. They are fitted with solid block acrylic vials that have been machined to exacting tolerances to ensure that the movement of the bubble is smooth and comes to rest quickly. A small magnifying area in the centre makes reading the position of the vial easier.



ADJUSTABLE VIAL LEVEL

The rotating vial can be adjusted to between 0° and 90°, enabling you to set angles for roofing or drainage pipes etc.



TORPEDO LEVEL

The FatMax® Xtreme Torpedo Level has a V groove machined in the magnetic base, which allows it to fit firmly on pipe work, ideal for scaffolders, plus it is also perfect for installing machinery, air conditioning ducting or shelving.

'I' BEAM LEVELS

I beam or girder section levels offer a lighter weight alternative, fitted with tubular 360° vials.



TORPEDO	CLASSIC BOX	BOX BEAM	I BEAM	DIGITAL
Traditional Practical Compact	Traditional Practical Strong Accurate Range of lengths	Practical Very Strong Accurate Range of lengths Magnetic available	Lightweight Strong Accurate Range of lengths Magnetic available	Lightweight Accurate Easy read Measures Angles Range of lengths

FATMAX® DIGITAL LEVEL

STANLEY
FATMAX



- Digital Level with illuminated LCD screen
- 360° readability – on-screen text rotates with the Level
- HOLD function and MODE function (degrees, percentage, cm-m)
- Memory up to 9 measurements
- Calibration function and own reference point setting
- Sound signal at 0°, 45° and 90°
- Low battery voltage notification
- Aluminum profile with handle and protective caps
- 2 vials: 1 horizontal and 1 vertical
- Accuracy in digital measurements: 0.1°, 0.2° in angles
- Supplied with waterproof bag and 2x AAA batteries

CODE	DESCRIPTION	☐	☒	☐	PRICE
0-42-065	FATMAX Digital Level 600 mm	X	1	3 2 5 3 5 6 0 4 2 0 6 5 9	
0-42-086	FATMAX Digital Level 1200 mm	X	1	3 2 5 3 5 6 0 4 2 0 8 6 4	

FATMAX® II LEVEL - STANDARD

STANLEY
FATMAX



- Aluminum Level
- 2 work surfaces
- Large horizontal center vial and 2 vertical vials
- Shock-absorbing end pieces
- Accuracy: +/- 0.5mm/m

CODE	DESCRIPTION	☐	☒	☐	PRICE
1-43-524	Level FATMAX 600 mm	-	1	3 2 5 3 5 6 1 4 3 5 2 4 9	
1-43-536	Level FATMAX 900 mm	-	1	3 2 5 3 5 6 1 4 3 5 3 6 2	
1-43-548	Level FATMAX 1200 mm	-	1	3 2 5 3 5 6 1 4 3 5 4 8 5	
1-43-572	Level FATMAX 1800 mm	-	1	3 2 5 3 5 6 1 4 3 5 7 2 0	

MAGNETIC LEVEL FATMAX® II

STANLEY
FATMAX



- Aluminum Level
- 2 work surfaces
- Strong magnets
- Large horizontal center vial and 2 vertical vials
- Shock-absorbing end pieces
- Accuracy: +/- 0.5mm/m

CODE	DESCRIPTION	☐	☒	☐	PRICE
1-43-525	Level FATMAX 600 mm Magnetic	-	1	3 2 5 3 5 6 1 4 3 5 2 5 6	
1-43-549	Level FATMAX 1200 mm Magnetic	-	1	3 2 5 3 5 6 1 4 3 5 4 9 2	

LEVEL CLASSIC PRO FATMAX®

STANLEY
FATMAX

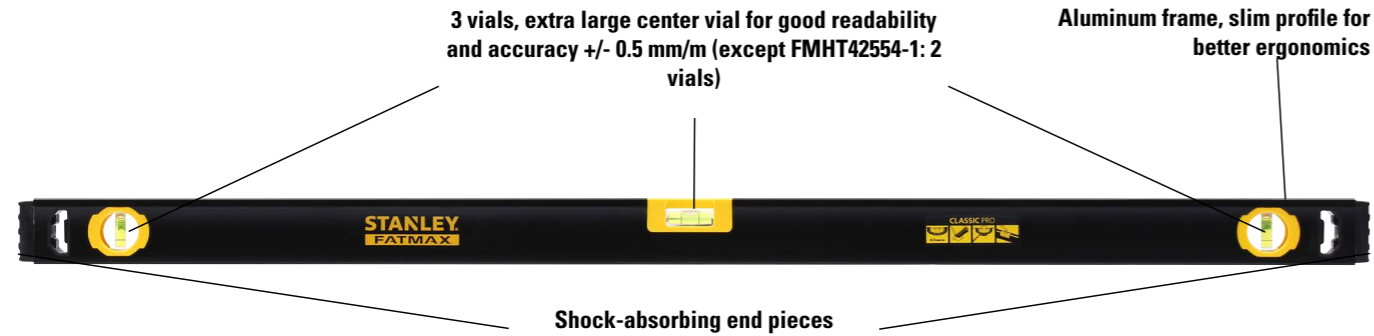

BOX BEAM LEVEL

The box section provides the ultimate in terms of overall strength and performance. They are fitted with solid block acrylic vials that have been machined to exacting tolerances to ensure that the movement of the bubble is smooth and comes to rest quickly. A small magnifying area in the centre makes reading the position of the vial easier.



CODE	DESCRIPTION				PRICE
FMHT42552-1	FATMAX Level classic PRO 400 mm	-	10	3253561425523	
FMHT42554-1	FATMAX Level classic PRO 600 mm	-	10	3 253561425547	
FMHT42447-1	FATMAX Level classic PRO 1000 mm	-	10	3 253561424472	
FMHT42559-1	FATMAX Level classic PRO 1200 mm	-	10	3 253561425592	
FMHT42561-1	FATMAX Level classic PRO 1800 mm	-	6	3 253561425615	

STANLEY® LEVEL CLASSIC

- Extra large center vial for good readability and accuracy to 0.5 mm/m
- Large, clearly visible side vials
- Shock-absorbing end pieces

CODE	DESCRIPTION				PRICE
STHT1-43102	Level Classic 400 mm	-	2	3 253561431029	
STHT1-43103	Level Classic 600 mm	-	2	3 253561431036	
STHT1-43104	Level Classic 800 mm	-	2	3 253561431043	
STHT1-43105	Level Classic 1000 mm	-	2	3 253561431050	
STHT1-43106	Level Classic 1200 mm	-	2	3 253561431067	
STHT1-43107	Level Classic 1500 mm	-	2	3 253561431074	
STHT1-43108	Level Classic 1800 mm	-	2	3 253561431081	
STHT1-43109	Level Classic 2000 mm	-	2	3 253561431098	
STHT6-97926	Level Classic - 600/1200/2000 mm	-	1	3253566979267	



STANLEY® LEVEL CLASSIC MAGNETIC

- Extra large center vial for good readability and accuracy to 0.5 mm/m
- Large, clearly visible side vials
- Shock-absorbing end pieces



CODE	DESCRIPTION				PRICE
STHT1-43110	Level Classic Magnetic 400 mm	-	2	3 253561431104	
STHT1-43111	Level Classic Magnetic 600 mm	-	2	3 253561431111	
STHT1-43112	Level Classic Magnetic 800 mm	-	2	3 253561431128	
STHT1-43114	Level Classic Magnetic 1200 mm	-	2	3 253561431142	
STHT1-43115	Level Classic Magnetic 1500 mm	-	2	3 253561431159	
STHT1-43116	Level Classic Magnetic 1800 mm	-	2	3 253561431166	
STHT1-43117	Level Classic Magnetic 2000 mm	-	2	3 253561431173	

BRICKLAYER'S LEVEL

- Aluminum version
- 2 vials: 1 vertical and 1 horizontal
- ABS handles



CODE	DESCRIPTION				PRICE
0-42-323	Bricklayer's Level 2000 mm - 2L	X	5	3 253560423230	

FATMAX® PRO I-BEAM LEVEL

STANLEY
FATMAX

- Durable vials with accuracy +/- 0.5 mm/m
- Cut-out for round tube measurements
- Shock-absorbing end pieces
- Light, extra strong aluminum I-profile



CODE	DESCRIPTION				PRICE
XTHT1-42131	FATMAX Levelx I-beam Pro 600mm	-	2	3 253561421310	
XTHT1-42134	FATMAX Pro I-beam Level 1200 mm	-	2	3 253561421341	
XTHT1-42138	FATMAX Pro I-beam Level 1800 mm	-	2	3 253561421389	

FATMAX® PRO I-BEAM LEVEL MAGNETIC

STANLEY
FATMAX



- Durable vials with accuracy +/- 0.5 mm/m
- Cut-out for round tube measurements
- Shock-absorbing end pieces
- Light, extra strong aluminum I-profile

CODE	DESCRIPTION	☞	☒	☐	PRICE
XTHT1-42132	FATMAX Pro I-beam Level magnetic 600 mm	-	2	3	2 5 3 5 6 1 4 2 1 3 2 7
XTHT1-42135	FATMAX Pro I-beam Level magnetic 1200 mm	-	2	3	2 5 3 5 6 1 4 2 1 3 5 8
XTHT1-42140	FATMAX Pro I-beam Level magnetic 1800 mm	-	2	3	2 5 3 5 6 1 4 2 1 4 0 2
XTHT1-42139	FATMAX Pro I-beam Level magnetic 2000 mm	-	2	3	2 5 3 5 6 1 4 2 1 3 9 6

FATMAX® I-BEAM LEVEL

STANLEY
FATMAX



- Aluminium profile
- 3 vials, extra large center vial for good readability
- Accuracy 0.5mm/m
- Measurements (cm) at the top - except 180cm
- Shock-absorbing end pieces

CODE	DESCRIPTION	☞	☒	☐	PRICE
1-43-553	FATMAX I-beam Level 600 mm	-	2	3	2 5 3 5 6 1 4 3 5 5 3 9
1-43-555	FATMAX I-beam Level 1200 mm	-	2	3	2 5 3 5 6 1 4 3 5 5 3 3
1-43-557	FATMAX I-beam Level 1800 mm	-	2	3	2 5 3 5 6 1 4 3 5 5 7 7

FATMAX® I-BEAM LEVEL MAGNETIC

STANLEY
FATMAX

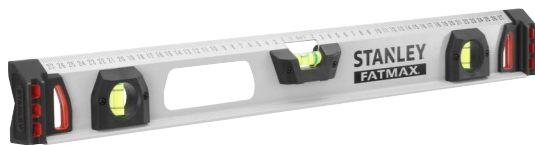

- Aluminium profile
- 3 vials, extra large center vial for good readability
- Accuracy 0.5mm/m
- Measurements (cm) at the top - except 200cm
- Shock-absorbing end pieces

CODE	DESCRIPTION	☞	☒	☐	PRICE
1-43-554	FATMAX I-beam Level Magnetic 600 mm	-	2	3	2 5 3 5 6 1 4 3 5 5 4 6
1-43-556	FATMAX I-beam Level Magnetic 1200 mm	-	2	3	2 5 3 5 6 1 4 3 5 5 6 0
1-43-558	FATMAX I-beam Level Magnetic 2000 mm	-	2	3	2 5 3 5 6 1 4 3 5 5 8 4

STANLEY® LEVEL I-BEAM



- I profile
- Durable heavy-duty aluminum support bar
- 3 tubular vials: 1x vertical, 1x horizontal, 1x 180° adjustable (double tick marks from 0° to 90° and in 10 increments)
- Thanks to shock-absorbing end pieces, accuracy is preserved - even if the Level falls
- Accuracy: 1.5mm/m

CODE	DESCRIPTION	☞	☒	☐	PRICE
1-42-920	Level I-Beam 600 mm 3L with 180° vial	-	6	3	2 5 3 5 6 1 4 2 9 2 0 0
1-42-921	Level I-Beam 800 mm 3L with 180° vial*	-	6	3	2 5 3 5 6 1 4 2 9 2 1 7
1-42-922	Level I-Beam 1000 mm 3L with 180° vial*	-	6	3	2 5 3 5 6 1 4 2 9 2 2 4
1-42-923	Level I-Beam 1200 mm 3L with 180° vial*	-	6	3	2 5 3 5 6 1 4 2 9 2 3 1

*Not in the Nordic assortment - special order required

STANLEY® I-BEAM LEVEL



- V-groove in work surface, for round tube applications
- Aluminum construction with yellow powder coating: surface protection
- 3 vials (Ø12 mm diameter): 180°, 90° and 45° (except 30cm version: 2 vials: 180° and 90°)
- Dragonflies protected with plastic
- Continuous work surface with window at the top
- Accuracy: 2.0mm/m
- Plastic end pieces

CODE	DESCRIPTION	☞	☒	☐	PRICE
0-42-072	Level I-beam 300 mm - 2L	-	10	3	2 5 3 5 6 2 4 2 0 7 2 5
0-42-073	Level I-beam 450 mm - 3L	-	10	3	2 5 3 5 6 1 4 2 0 7 3 3
0-42-074	Level I-beam 600 mm - 3L	-	10	3	2 5 3 5 6 1 4 2 0 7 4 0
0-42-076	Level I-beam 1200 mm - 3L	-	10	3	2 5 3 5 6 1 4 2 0 7 6 4

FATMAX® PRO BOX TORPEDO LEVEL

STANLEY
FATMAX



- Box torpedo Level with two fixed vials and a 360° rotating vial for flexible measuring
- Oversized center vial for easier reading and increased accuracy
- Magnetic base for easier working on steel structures and scaffolding
- No-Mar rubber end caps for greater shock resistance
- Extruded aluminum housing for increased strength and reduced weight
- Accuracy: 0.5mm/m

CODE	DESCRIPTION				PRICE
XTH10-42495	FATMAX Pro Box Torpedo Level	X	6		

FATMAX® PRO TORPEDO LEVEL

STANLEY
FATMAX



- Aluminum construction
- 3 vials, of which 1 extra large middle vial and 1 180° rotatable vial
- Sole with built-in magnet and groove

CODE	DESCRIPTION				PRICE
0-43-609	FATMAX Pro Torpedo Level 250mm - 3L	X	6		

FATMAX® TORPEDO LEVEL

STANLEY
FATMAX



- Cast aluminum frame for maximum durability
- Solid dragonflies
- Accuracy: 0.5mm/m
- Extra large middle dragonfly
- Strong magnets
- Groove for use on round surfaces

CODE	DESCRIPTION				PRICE
0-43-603	FATMAX™ Torpedo Level	X	6		

STANLEY® LEVEL TORPEDO



- Sturdy, shock-resistant aluminum frame
- Shockproof center vial
- Accuracy: 2.0mm/m
- With magnetic base: hands-free leveling on metal constructions or when laying pipes

CODE	DESCRIPTION				PRICE
0-43-511	Level Torpedo 250 mm Alu Magnetic - 3L	X	6		

STANLEY® LEVEL TORPEDO PLASTIC



- Light ABS housing for strength
- 3 vials: 1x vertical, 1x horizontal, 1x 45°

CODE	DESCRIPTION				PRICE
0-42-294	Level Torpedo 200 mm - 3L	X	6		

STANLEY® ALUMINIUM MAGNETIC TORPEDO LEVEL



- 3 vials: horizontal, plumb and 45°
- Magnetic base ideal for steel construction
- Strong & lightweight aluminium body ideal for small installations

CODE	DESCRIPTION				PRICE
0-42-465	Aluminium Magnetic Torpedo Level - 23 cm	X	6		

WATER LEVEL



- Hose Level
- 2 transparent vials with graduations
- For long distance Levels (hose not included)
- mm division

CODE	DESCRIPTION				PRICE
0-42-430	Hose Level	X	6		

LINE LEVEL



- Light aluminum version with hooks for use on a line
- Ideal for leveling on large surfaces
- Ideal for landscaping

CODE	DESCRIPTION				PRICE
0-42-287	Line Level 80 mm	X	6		

POCKET LEVEL



- Clearly legible vials
- Compact
- Magnetic
- Belt clip

CODE	DESCRIPTION				PRICE
0-42-130	Pocket Level	-	6	3 253560 421304	

POST LEVEL MAGNETIC



- Foldable corner Level
- Magnetic
- Suitable for angles from 0-180°
- On board storage of line level

CODE	DESCRIPTION				PRICE
0-47-720	Post Level magnetic	-	4	3 253560 477202	





THE STANLEY® LASER RANGE

Accurate measurement is essential for trouble free construction sites, speeding up the job and minimising waste and reworked tasks. Our aim has been to create a range of complimentary products - all built to our exacting standards - to enable professional users work quickly and accurately. That's why the STANLEY® Laser Tools range offers all the benefits of durable and well engineered products with user friendly features and features designed for the professional user.

LASER DISTANCE MEASURES

MODEL	TLM40 STHT77666-0	TLM50 STHT1-77409	SLM65 STHT77065-0	SLM100 STHT77100-0	
MAIN FEATURES	1 Distance	☐	☐	☐	
	2 Area	-	-	☐	
	3 Volume	-	-	☐	
	4 Height	-	-	-	
	5 Combined height	-	-	-	
	6 Tracking	☐	☐	☐	
	7 Height tracking	-	-	-	
	8 Distance with obstacle	-	-	-	
	9 Triangular area measurement	-	-	-	
	10 Partial height	-	-	-	
	11 Stake out function	-	-	-	
SPECIFICATIONS	Working range (min / max)	0.17 - 12m	0.17 - 15m	0.17 - 20m	0.17 - 30m
	Accuracy	±6mm @ 10m	±3mm @ 10m	±3mm @ 10m	±3mm @ 10m
	Inclination sensor	-	-	-	-
	Water/dust protection	-	IP40	IP40	IP40
	Screen	1 waarde	2 waarden	4 waarden	4 waarden
	Screen lighting	-	-	-	-
	Sound signal	-	-	-	-
	Calculation function +/-	-	-	-	-
	Memory	-	1	2	3
	Timer	-	-	-	-
	Fold-out pin	-	-	-	-
	Digital zoom (x4)	-	-	-	-
	Automatic shutdown (laser/device)	≤ 90 sec	≤ 120 sec	≤ 120 sec	≤ 120 sec
	Measurements per set of batteries	-	> 3000	> 3000	> 3000
	Batteries (included)	internal battery	2x AAA	2x AAA	2x AAA
Suitable for tripod (1/4")	-	-	-	-	
Storage pouch included	-	-	-	-	

1 2 3 4 5 6 7 8 9 10 11

CALCULATE OF SLOPE DEGREE

CALCULATION OF DISTANCES

ESTIMATING HEIGHTS: calculate a height with 2 or 3 points.

CALCULATION OF PERIMETERS

TRACKING FUNCTION: Minimum or maximum distance per scan.

LASER DISTANCE MEASURES

MODEL	FLM165 FMHT77165-0	TLM165s STHT1-77139	TLM165si STHT1-77142	TLM330 STHT1-77140	
MAIN FEATURES	1 Distance	☐	☐	☐	
	2 Area	☐	☐	☐	
	3 Volume	☐	☐	☐	
	4 Height	-	☐	☐	
	5 Combined height	-	☐	☐	
	6 Tracking	☐	☐	☐	
	7 Height tracking	-	☐	☐	
	8 Distance with obstacle	-	☐	☐	
	9 Triangular area measurement	-	☐	☐	
	10 Shared height	-	☐	☐	
	11 Stake out function	-	☐	☐	
SPECIFICATIONS	Working range (min / max)	0.17 - 50m	0.15 - 50m	0.15 - 60m	0.15 - 100m
	Accuracy	±1.5mm @ 10m	±1.5mm @ 10m	±1.5mm @ 10m	±1mm @ 10m
	Inclination sensor	-	☐	☐	☐
	Water/dust protection	IP40	IP54	IP54	IP54
	Screen	4 values	Touchscreen, 3 values	Touchscreen, 3 values	Touchscreen, 3 values
	Screen lighting	-	-	-	☐
	Sound signal	-	-	-	☐
	Calculation function +/-	☐	☐	☐	☐
	Memory	-	10	10	20
	Timer	-	0-60 sec	0-60 sec	0-60 sec
	Fold-out pin	-	☐	☐	☐
	Digital zoom (x4)	-	-	-	-
	Automatic shutdown (laser/device)	≤ 90 sec	≤ 30-60-300 sec	≤ 30-60-300 sec	≤ 30-60-90 sec
	Measurements per set of batteries	> 3000	> 5000	> 5000	> 5000
	Batteries (included)	internal battery	3x AAA	3x AAA	3x AAA
Suitable for tripod (1/4")	-	☐	☐	☐	
Storage pouch included	-	☐	☐	☐	

STANLEY SMART CONNECT™

CAPTURE MEASUREMENTS

PHOTO MARKUPS

ROOM PLANNER

Available on the App Store

ANDROID APP ON Google play

DISTANCE MEASURING

LASER DISTANCE MEASURER TLM330 - 100 M



- Smartconnect app via Bluetooth®
- Range: 0.15 - 100m
- Accuracy: 1.5mm @ 10m
- Measurements: distance - area - volume - Pythagoras
- Continuous measurement function
- Calculation function
- Fore, aft, tripod and angle measurement
- Memory function: 20 values
- Touch screen: backlit, 3 value display
- IP54 dust and water resistant
- With tilt sensor
- Auto off (30 - 60 - 300 sec.)
- Standard tripod thread 1/4"
- Functions: Distance, Area, Volume, Height, Combined Height, Continuous Distance Measurement, Continuous Height Measurement, Obstacle Distance, Triangle, Shared Height, Interval
- Ideal for architects
- Measurements per set of batteries: 5000
- Supplied with batteries 3× AAA and storage bag

CODE	DESCRIPTION				PRICE
STHT1-77140	Laser distance Measurer TLM330 - 100 m	X	2	3 2535611771408	203.40

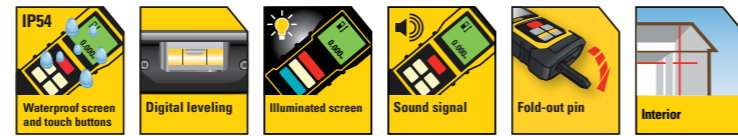

LASER DISTANCE MEASURER TLM165 si - 60M



- Smartconnect app via Bluetooth®
- Range: 0.15 - 60m
- Accuracy: 1.5mm @ 10m
- Measurements: distance - area - volume - Pythagoras
- Continuous measurement function
- Calculation function
- Fore, aft, tripod and angle measurement
- Memory function: 10 values
- Touch screen: backlit, 3 value display
- IP54 dust and water resistant
- With tilt sensor
- Auto off (30 - 60 - 300 sec.)
- Standard tripod thread 1/4"
- Functions: Distance, Area, Volume, Height, Combined Height, Continuous Distance Measurement, Continuous Height Measurement, Obstacle Distance, Triangle, Shared Height, Interval
- Ideal for architects
- Measurements per set of batteries: 5000
- Supplied with batteries 3× AAA and storage bag

CODE	DESCRIPTION				PRICE
STHT1-77142	Laser distance Measurer TLM165si - 60 m	X	2	3 2535611771422	135.25

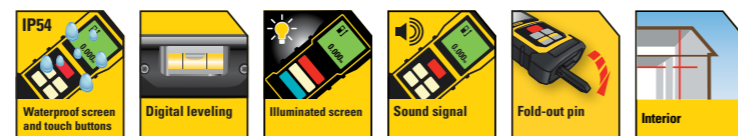

LASER DISTANCE MEASURER TLM165 s - 50M



- Smartconnect app via Bluetooth®
- Range: 0.15 - 50m
- Accuracy: 1.5mm @ 10m
- Measurements: distance - area - volume - Pythagoras
- Continuous measurement function
- Calculation function
- Fore, aft, tripod and angle measurement
- Memory function: 10 values
- Touch screen: backlit, 3 value display
- IP54 dust and water resistant
- With tilt sensor
- Auto off (30 - 60 - 300 sec.)
- Standard tripod thread 1/4"
- Functions: Distance, Area, Volume, Elevation, Combined Height, Continuous Distance Measurement, Continuous Height Measurement, Obstacle Distance, Triangle, Shared Height, Interval
- Ideal for architects
- Measurements per set of batteries: 5000
- Supplied with batteries 3× AAA and storage bag

CODE	DESCRIPTION				PRICE
STHT1-77139	Laser distance Measurer TLM165s - 50 m	X	2	3 2535611771392	125.00

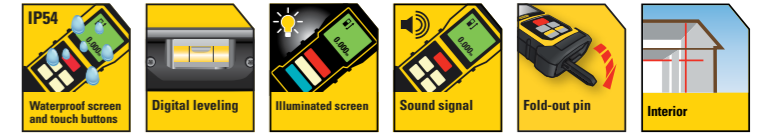

LASER DISTANCE MEASURER FLM165 - 50 M



- Measuring range of 50m with accuracy of +/- 1.5mm
- Delivers accurate distance, area, volume, Pythagorean and continuous measurements
- Calculation function (+/-)
- Metric and imperial units of measurement
- Internal rechargeable lithium-ion battery provides impressive runtime - up to 1000 readings per charge
- Internal Lithium-Ion battery can be fully charged in 2.5 hours
- Automatic power saving mode to save battery
- Easy to use, two-button operation
- Black LCD screen with clear white characters for excellent visibility, even in high ambient light
- Robust rubber-protected housing for better grip and long product life
- IP40 rating against dust and water ingress

CODE	DESCRIPTION				PRICE
FMHT77165-0	Laser distance Measurer FLM165 - 50 m	X	6	3 2535601771652	99.75

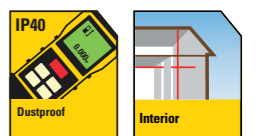

SLM100 LASER DISTANCE MEASURER - 30M



- 30 m measuring range - suitable for a wide variety of professional measuring applications
- Black LCD screen with white characters for excellent visibility, even in high ambient light
- Two-button operation for ease of use
- On/Measure button for taking measurements and a button to change function
- Two-point measurement system - measurements can be taken from the front or back of the device for added flexibility and accuracy in various measurement applications
- Energy saving mode - device automatically turns off when inactive after 120 seconds (laser), 180 seconds (display)
- Large screen size - displays three rows of measurements on screen at any given time
- Drop test from 1 m height – shockproof

CODE	DESCRIPTION				PRICE
STHT77100-0	Laser distance Measurer SLM100 - 30 m	X	6		68.25

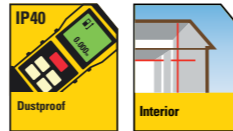

NEW

SLM65 LASER DISTANCE MEASURER - 20 M



- 20 m measuring range - suitable for a wide variety of professional measuring applications
- Black LCD screen with white characters for excellent visibility, even in high ambient light
- Two-button operation for ease of use
- On/Measure button for taking measurements and a button to change function
- Two-point measurement system - measurements can be taken from the front or back of the device for added flexibility and accuracy in various measurement applications
- Energy saving mode - device automatically turns off when inactive after 120 seconds (laser), 180 seconds (display)
- Large screen size - displays two rows of measurements on screen at any given time
- Drop test from 1 m height – shockproof

CODE	DESCRIPTION				PRICE
STHT77065-0	Laser distance Measurer SLM65 - 20 m	X	6		57.75

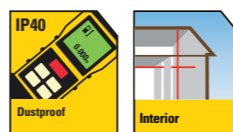

NEW

LASER DISTANCE MEASURER TLM50 - 15 M



- Range: 0.17 - 15m
- Accuracy: 3mm @ 10m
- Measurements: distance
- Continuous measurement function
- Back measurement
- Black screen with white letters - better readability
- IP54 dust and water resistant
- 1 value display on screen
- Auto off (90 sec)
- Functions: Distance, Continuous distance measurement
- Measurements per set of batteries: 3000
- Supplied with batteries 2x AAA

CODE	DESCRIPTION				PRICE
STHT1-77409	Laser distance Measurer TLM50 - 15 m	X	8		46.95

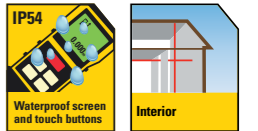

POCKET LASER DISTANCE MEASURER TLM40 – 12 M



- Range: 12 m
- Accuracy: +/-6mm @ 10m
- Measurements: distance
- Continuous measurement function
- Black screen with white letters - better readability
- soft grip
- Operation with 1 button
- Internal lithium ion battery
- Auto off (90 sec)
- Functions: Distance, Continuous distance measurement
- Supplied with USB charging cable

CODE	DESCRIPTION				PRICE
STHT77666-0	Pocket Laser distance Measurer TLM40 – 12 m	X	6		34.10

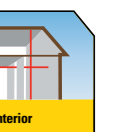



THE RIGHT LASER FOR EVERY JOB

THE MAIN TYPES OF STANLEY LASER LEVELS



Level



Rotating



Spot line/cross



Cross + spot line



Spot line

ARE LASERS POSSIBLY DANGEROUS?

In terms of their potential hazards, lasers are classified from 1 to 4. STANLEY lasers are classified as 1 to 2, meaning they pose little or no hazard.

Class 1 - Does not pose a risk of biological damage.

Class 2 - The laser could injure a person if they stare into the beam for a long time.

WHAT IS A LASER?

LASER stands for "Light Amplification by Stimulated Emission of Radiation". A diode is used to create a concentrated laser beam in one wavelength. The shorter the wavelength, the brighter and more visible the laser beam. STANLEY lasers have a standard wavelength of 635 nanometers, suitable for use over distances of up to 300m.

IP-CLASS

If you work in dusty and humid environments, the IP rating of the laser is also important. Some STANLEY lasers have an IP54 rating (dust resistant and splash proof) or IP66 rating (dust resistant and completely waterproof).



Corners and slopes

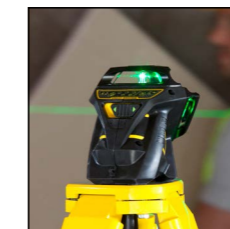

Straight lines



Plumb line - take a point from floor to ceiling



Horizontal/Vertical level and alignment

REPAIR UNDER WARRANTY AND CHECK SERVICE

All STANLEY laser products come with a one-year warranty. During this period, repairs under "normal" use are free of charge. For repairs under warranty, you must contact your dealer, who will send the product to STANLEY for repair. The product will then be repaired and returned to your dealer, who will in turn deliver it to you. Also follow the above procedure for out-of-warranty repairs. You will then first receive a quotation for the repair so that you can decide whether or not the repair should be carried out or not. We recommend that you have products serviced annually and calibrated every 6 months.

TAKE FOR SERVICE OR REPAIRS CONTACT

NORDICS: Aftersales.nordic@sbdinc.com

Sweden: +46 844680277

Norway: +47 37715559

Denmark: +45 89872256

Finland: +35 8942455223

LEVELING FEATURES

Listed below are the common leveling functions you can perform with the STANLEY® range.

ROTATING LASERS

		X-AS	Y-AS	
Horizontal Rotary 360° Beam	Vertical Rotary 360° Beam	Slope +/- 10%	Slope +/- 10%	
Horizontal 360° beam with vertical spot	Vertical 360° beam with horizontal spot	Slope +/- 10% with Vertical Spot	Slope +/- 10% with Vertical Spot	Scanning horizontal with vertical spot
Horizontal 360° Beam with Vertical Spot and Plumb Bob	Vertical 360° Beam with 2x Horizontal Spots	Slope +/- 10% with Vertical Spot and Plumb Bob	Slope +/- 10% with Vertical Spot and Plumb Bob	Scanning Horizontal with Vertical Spot and Plumb Bob

CROSS LINE LASERS

1x Horizontal Line	1x Vertical Line	2x Vertical Spots Plumb Bob	1x Cross Line with Plumb Bob
1x Horizontal Line	Vertical Line and Return	Cross Line and Return	
Horizontal Beam with Plumb Bob	1x Cross Line and Plumb Bob	2x Cross Line with Plumb Bob	3x Cross Line with Vertical Back Line and Plumb Bob

SPOT LASERS

5 Spot

360° LASERS

STANLEY® FATMAX® 35/50 M X3G GREEN BEAM MULTI-LINE LASER LEVEL

STANLEY
FATMAX

GREENLASER



- Range: 30 m and up to 50 m with detector (not included)
- Accuracy: 3mm @ 10m
- Self-levelling up to ± 4°
- Leveling Time: ≤ 3sec
- Projects 6 cross lines simultaneously, or each 360° line separately
- Reaches walls, floors and ceilings
- Pulse mode for use with detector (not included)
- IP54 dust and water resistant
- Lockable pendulum for durable transport
- Robust, shock-resistant housing
- Standard thread for tripod 1/4" and 5/8"
- Lithium Ion battery
- Supplied in sturdy PRO-STACK case (can be combined with TSTAK) with charger, multifunctional bracket, laser glasses and target card

CODE	DESCRIPTION				PRICE
FMHT1-77356	FATMAX® 35/50 m X3G Green Beam Multi-Line Laser Level	-	2	3 253561 773563	

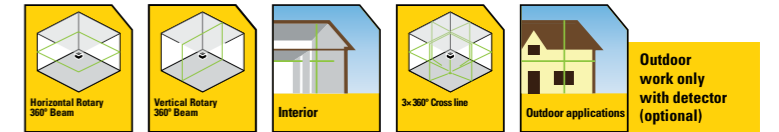

STANLEY® FATMAX® X3R RED BEAM MULTI-LINE 20/50 M LASER LEVEL

STANLEY
FATMAX

REDLASER



- Range: 20 m and up to 50 m with detector (not included)
- Accuracy: 3mm @ 10m
- Self-levelling up to ± 4°
- Leveling Time: ≤ 3sec
- Projects 6 cross lines simultaneously or each 360° line separately
- Reaches walls, floors and ceilings
- Pulse mode for use with detector (not included)
- IP54 dust and water resistant
- Lockable pendulum for durable transport
- Robust, shock-resistant housing
- Standard thread for tripod 1/4" and 5/8"
- Lithium Ion battery
- Supplied in sturdy PRO-STACK case (can be combined with TSTAK) with charger, multifunctional bracket, laser glasses and target card

CODE	DESCRIPTION				PRICE
FMHT1-77357	FATMAX X3R Multi-Line Laser 3x 360° with red beam	-	2	3 253561 773570	

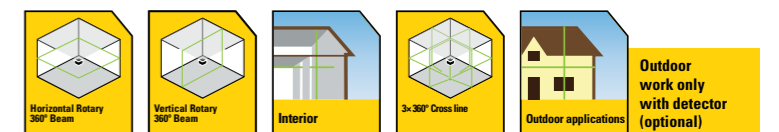

STANLEY® FATMAX® 360° V2 GREEN BEAM LASER LEVEL

**STANLEY
FATMAX**

GREENLASER



- Working range: 30 m and up to 50 m with detector (not included)
- Accuracy: 3 mm @ 10 m line, 6 mm @ 10 m point
- Self-levelling up to $\pm 4^\circ$
- Leveling Time: ≤ 5 sec
- Projects one 360° horizontal line + 2 vertical lines with an angle of 120° + 1 plumb bob
- High visibility, ideal for metal stud alignment for drywall
- Magnetic base to attach to metal studs
- Pulse mode for use with detector (not included)
- IP54 dust and water resistant
- Durable design with rubber housing
- 1.5 m drop test
- Lockable pendulum for durable transport
- Standard thread for tripod 1/4" and 5/8"
- Green: 7,2V, 2Ah - Li-Ion battery, Red: 4xAA Alkaline
- Supplied in sturdy PRO-STACK case (can be combined with TSTAK) with charger, multifunctional bracket, laser glasses and target card

CODE	DESCRIPTION				PRICE
FMHT77617-1	STANLEY® FATMAX® 360° V2 Green Beam Laser Level	-	2	3 253561 776175	
FMHT1-77416	STANLEY® FATMAX® 360° Red Beam Laser Level	-	2	3253561774164	

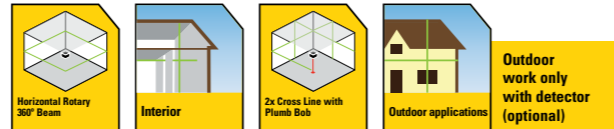

LINE LASER SLL360° GREEN - 25 M

GREENLASER



- Range: 25 m
- Accuracy: 4mm @ 10m
- Self-levelling up to $\pm 4^\circ$
- Leveling Time: ≤ 5 sec
- Projects a self-levelling 360° line and 1 vertical line
- Convenient placement with the 360° clamp
- Lockable pendulum for durable transport
- User-friendly push button
- Large base for extra stability
- IP50 dust and water resistant
- Standard tripod thread 1/4"
- Robust housing with rubber protection
- Supplied with storage bag, 4x AA batteries and 360° clamp

CODE	DESCRIPTION				PRICE
STHT77594-1	Line laser SLL360° green	X	2	3 253561 775949	

CODE	DESCRIPTION				PRICE
STHT77641-1	Line laser SLL360° green - kit with tripod				3253561776410

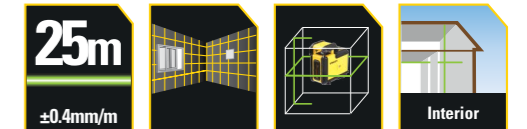

LINE LASER SLL360° RED - 20 M

REDLASER



- Range: 20 m
- Accuracy: 4mm @ 10m
- Self-levelling up to $\pm 4^\circ$
- Leveling Time: ≤ 5 sec
- Projects a self-levelling 360° line and 1 vertical line
- Convenient placement with the 360° clamp
- Lockable pendulum for durable transport
- User-friendly push button
- Large base for extra stability
- IP50 dust and water resistant
- Standard tripod thread 1/4"
- Robust housing with rubber protection
- Supplied with storage bag, 4x AA batteries and 360° clamp

CODE	DESCRIPTION				PRICE
STHT77504-1	Line laser SLL360° red	X	2	3 253561 775048	

CODE	DESCRIPTION				PRICE
STHT77640-1	Line laser SLL360° red - kit with tripod				3253561776403

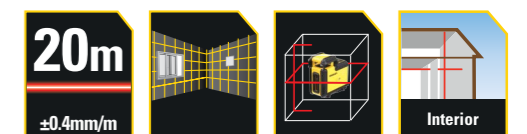

CROSS LASERS

FATMAX® SCGI-P5 5 POINT + CROSS LINE LASER GREEN LI-ION

STANLEY
FATMAX **GREENLASER**

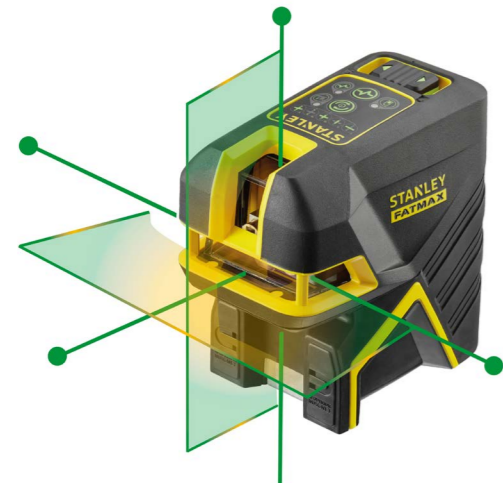

- Range line: 30 m and up to 50 m with detector (not included)
- Range point: 45 m
- Accuracy: 3 mm @ 10 m line, 6 mm @ 10 m point
- Self-levelling up to ± 4°
- Leveling Time: ≤ 5sec
- Pulse mode for use with detector (not included)
- Projects 1 horizontal and 1 vertical line + 5 individual points
- Projects self-leveling lines up to 150° thanks to continuous windows
- Magnetic base to attach to metal studs
- IP54 dust and water resistant
- Lockable pendulum for durable transport
- Standard thread for tripod 1/4" and 5/8"
- Supplied in sturdy PRO-STACK case (combinable with TSTAK) with charger, multifunctional bracket, laser glasses and target card



CODE	DESCRIPTION				PRICE
FMHT77598-1	FATMAX SCGI-P5 5 point + cross line laser green Li-ion	-	2	3 253561 775987	

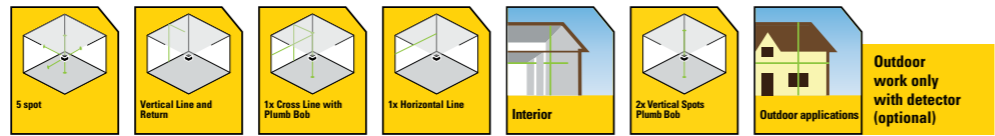

FATMAX® SCR-P5 5-POINT + CROSS LINE LASER RED

STANLEY
FATMAX **REDLASER**



- Range line: 20 m and up to 50 m with detector (not included)
- Range point: 30 m
- Accuracy: 3 mm @ 10 m line, 6 mm @ 10 m point
- Self-levelling up to ± 4°
- Leveling Time: ≤ 3sec
- Pulse mode for use with detector (not included)
- Projects 1 horizontal and 1 vertical line + 5 individual points
- Projects self-leveling lines up to 150° thanks to continuous windows
- Magnetic base to attach to metal studs
- IP54 dust and water resistant
- Lockable pendulum for durable transport
- Standard thread for tripod 1/4" and 5/8"
- Supplied in sturdy PRO-STACK case (combinable with TSTAK) with 4x AA batteries, multifunctional bracket, laser glasses and target card



CODE	DESCRIPTION				PRICE
FMHT1-77415	FATMAX SCR-P5 5-point + cross line laser red	-	2	3 253561 774157	

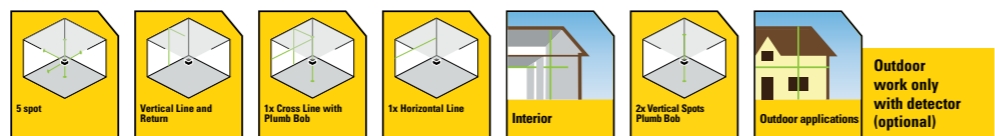

FATMAX® FCL-GI CROSS LINE LASER GREEN LI-ION

STANLEY
FATMAX **GREENLASER**



- Range line: 30 m and up to 50 m with detector (not included)
- Accuracy: 3mm @ 10m line
- Self-levelling up to ± 4°
- Leveling Time: ≤ 5sec
- Pulse mode for use with detector (not included)
- Projects 1 horizontal and 1 vertical line
- Projects self-leveling lines up to 150° thanks to continuous windows
- Magnetic base to attach to metal studs and fine tune
- IP54 dust and water resistant
- Lockable pendulum for durable transport
- Standard thread for tripod 1/4" and 5/8"
- Supplied in sturdy PRO-STACK case (combinable with TSTAK) with charger, multifunctional bracket and target card



CODE	DESCRIPTION				PRICE
FMHT77595-1	FATMAX FCL-Gi Cross Line Laser Green Li-ion	-	2	3 253561 775956	

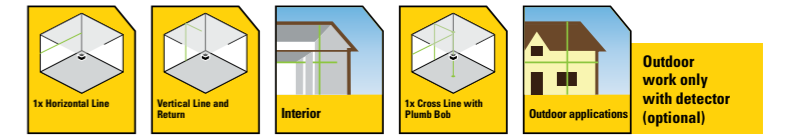

FATMAX® FCL-G CROSS LINE LASER GREEN ALKALINE

STANLEY
FATMAX **GREENLASER**



- Range line: 30 m and up to 50 m with detector (not included)
- Accuracy: 3mm @ 10m line
- Self-levelling up to ± 4°
- Leveling Time: ≤ 5sec
- Pulse mode for use with detector (not included)
- Projects 1 horizontal and 1 vertical line
- Projects self-leveling lines up to 150° thanks to continuous windows
- Magnetic base to attach to metal studs
- IP54 dust and water resistant
- Lockable pendulum for durable transport
- Standard thread for tripod 1/4" and 5/8"
- Supplied with storage bag and 4x AA batteries



CODE	DESCRIPTION				PRICE
FMHT77586-1	FATMAX FCL-G Cross Line Laser Green Alkaline	-	2	3 253561 775864	

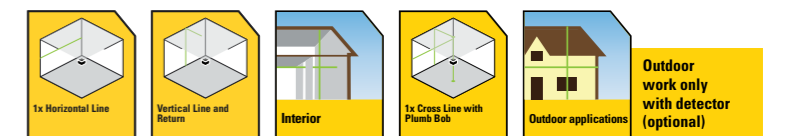

FATMAX® FCL-R CROSS LINE LASER RED ALKALINE

STANLEY
FATMAX

REDLASER



- Range line: 20 m and up to 50 m with detector (not included)
- Accuracy: 3mm @ 10m line
- Self-levelling up to $\pm 4^\circ$
- Leveling Time: ≤ 5 sec
- Pulse mode for use with detector (not included)
- Projects 1 horizontal and 1 vertical line
- Projects self-leveling lines up to 150° thanks to continuous windows
- Magnetic base to attach to metal studs
- IP54 dust and water resistant
- Lockable pendulum for durable transport
- Standard thread for tripod 1/4" and 5/8"
- Supplied with storage bag and 4x AA batteries



CODE	DESCRIPTION				PRICE
FMHT77585-1	FATMAX FCL-R Cross Line Laser Red Alkaline	-	1	3 253561 775857	

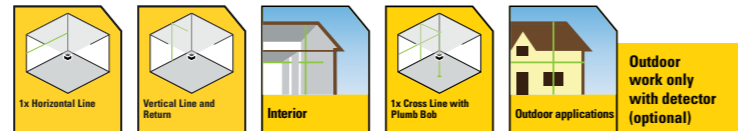

CROSS LINE LASER CROSS90™ GREEN - 16 M

GREENLASER



- Range: 16 m
- Accuracy: 5mm @ 10m
- Self-levelling up to $\pm 4^\circ$
- Leveling Time: ≤ 5 sec
- Self-levelling cross line laser with additional 90° laser line
- Manual mode to stake out angle lines
- Lockable pendulum for durable transport
- Convenient placement with the 360° clamp
- Robust housing with rubber protection
- IP50 dust and water resistant
- Standard tripod thread 1/4"
- Supplied with 2x AA batteries, storage bag, 360° clamp

CODE	DESCRIPTION				PRICE
STHT77592-1	Cross line laser Cross90 green	X	2	3 253561 775925	



FATMAX® SCR-P2 2-POINT + CROSS LINE LASER RED OR GREEN

STANLEY
FATMAX

REDLASER



- Range line: 20 m and up to 50 m with detector (not included)
- Range point: 30 m red, 45 m green
- Accuracy: ± 2 mm @ 10m line, 6 mm @ 10 m point
- Self-levelling up to $\pm 4^\circ$
- Leveling Time: ≤ 3 sec
- Pulse mode for use with detector (not included)
- Projects 1 horizontal and 1 vertical line + 2 individual points
- Projects self-leveling lines up to 150° thanks to continuous windows
- Magnetic base to attach to metal studs and fine tune
- IP54 dust and water resistant
- Lockable pendulum for durable transport
- Standard thread for tripod 1/4" and 5/8"
- Supplied in sturdy PRO-STACK case (combinable with TSTAK) with 4x AA batteries (for FMHT1-77414), multifunctional bracket, laser glasses and target card
- FMHT77597-1 integrated battery (supplied)

GREENLASER



CODE	DESCRIPTION				PRICE
FMHT1-77414	FATMAX SCR-P2 2-point + cross line laser red	-	2	3 253561 774140	

CODE	DESCRIPTION				PRICE
FMHT77597-1	FATMAX SCG-P2 2-point + cross line laser green	-	2	3253561775970	

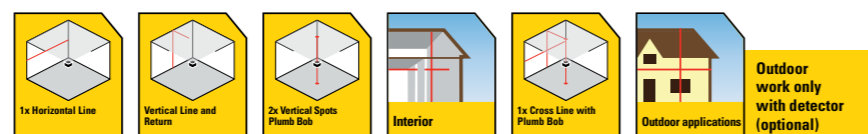

CROSS LINE LASER CROSS90™ RED - 12 M

REDLASER



- Range: 12 m
- Accuracy: 5mm @ 10m
- Self-levelling up to $\pm 4^\circ$
- Leveling Time: ≤ 5 sec
- Self-levelling cross line laser with additional 90° laser line
- Manual mode to stake out angle lines
- Lockable pendulum for durable transport
- Convenient placement with the 360° clamp
- Robust housing with rubber protection
- IP50 dust and water resistant
- Standard tripod thread 1/4"
- Supplied with 2x AA batteries, storage bag, 360° clamp

CODE	DESCRIPTION				PRICE
STHT77502-1	Cross line laser Cross90 red	X	2	3 253561 775024	

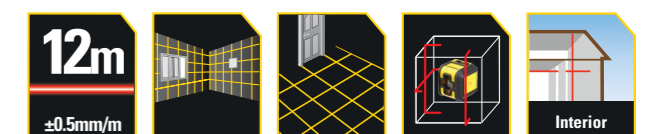

CROSS LINE LASER CUBIX™ GREEN - 16 M

GREENLASER



- Range: 16 m
- Accuracy: 6mm @ 10m
- Self-levelling up to ± 4°
- Leveling Time: ≤ 5sec
- Self-levelling cross line laser
- Manual mode to stake out angle lines
- Easy operation
- Lockable pendulum for durable transport
- Convenient placement with the 360° clamp
- Robust housing with rubber protection
- IP50 dust and water resistant
- Standard tripod thread 1/4"
- Supplied with 2x AA batteries, storage bag, 360° clamp

CODE	DESCRIPTION				PRICE
STHT77499-1	Cross line laser Cubix green	X	2		

CODE	DESCRIPTION				PRICE
STHT77649-1	Cross line laser Cubix green - kit with stand and bag			3253561776496	

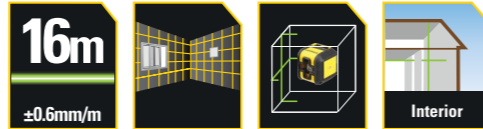

CROSS LINE LASER CUBIX™ RED - 12 M

REDLASER



- Range: 12 m
- Accuracy: 6mm @ 10m
- Self-levelling up to ± 4°
- Leveling Time: ≤ 5sec
- Self-levelling cross line laser
- Manual mode to stake out angle lines
- Easy operation
- Lockable pendulum for durable transport
- Convenient placement with the 360° clamp
- Robust housing with rubber protection
- IP50 dust and water resistant
- Standard tripod thread 1/4"
- Supplied with 2x AA batteries, storage bag, 360° clamp

CODE	DESCRIPTION				PRICE
STHT77498-1	Cross line laser Cubix red	X	2		

CODE	DESCRIPTION				PRICE
STHT77648-1	Cross line laser Cubix red - kit with stand and bag			3253561776489	

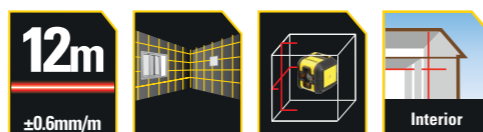

POINT LASER

FATMAX® SPR5 5-POINT LASER RED OR GREEN

**STANLEY
FATMAX**

REDLASER



GREENLASER



- Range: 30 m red, 45 m green
- Accuracy: +/-2mm @10m
- Self-levelling up to ± 4°
- Leveling Time: ≤ 3sec
- Projects 5 laser points
- Ideal for plotting levels
- Magnetic sole allows the laser to be placed on metal frames
- IP54 dust and water resistant
- Lockable pendulum for durable transport
- Standard thread for tripod 1/4" and 5/8"
- Supplied in storage bag with 4 rechargeable batteries, battery charger, bracket, target card
- FMHT77596-1- integrated battery (supplied)

CODE	DESCRIPTION				PRICE
FMHT1-77413	FATMAX SPR5 5-point laser red	-	2		

CODE	DESCRIPTION				PRICE
FMHT77596-1	FATMAX SPG5 5-point laser green	-	2	3253561775963	

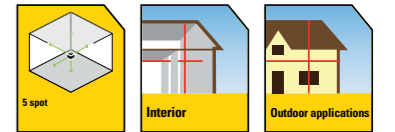

SPL3 3-POINT LASER RED - 30 M

REDLASER



- Range: 30 m
- Accuracy: 3mm @ 10m
- Self-levelling up to ± 4°
- Leveling Time: ≤ 5sec
- Self-Leveling - Projects laser points up, down and horizontally
- Downbeam improves point visibility on drywall frames
- IP50 dust and water resistant
- Lockable pendulum for durable transport
- Standard tripod thread 1/4"
- Convenient placement with the 360° clamp
- Supplied with 2x AA batteries and 360° clamp

CODE	DESCRIPTION				PRICE
STHT77503-1	SPL3 3-point laser red	-	2		

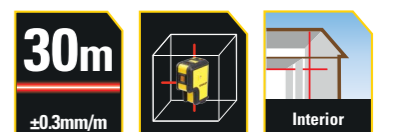

ROTARY LASERS

FATMAX® RL750LG ROTARY LASER LI-ION - GREEN

STANLEY
FATMAX



- Lines: Rotary, point up and down
- Laser class: Green, Class 2
- Operating range: 60 m - 600 m with receiver
- Accuracy: $\pm 1.5 \text{ mm} @ 30 \text{ m (H)} \pm 3 \text{ mm} @ 30 \text{ m (V)}$
- Accuracy Point: $\pm 3 \text{ mm} @ 30 \text{ m (up)}$
- RPM: 0-150-300-600 $\pm 8.7 \text{ mm} @ 30 \text{ m (down)}$
- Self-leveling range: $5^\circ \pm 1^\circ$ (any direction)
- Leveling Time (seconds): $\leq 30 \text{ s}$
- Double slope: 10°
- Scan mode
- IP66 dust and water resistant
- Tilt function
- Lithium Ion battery, 3.7V, 5.0Ah 40 hours
- Thread: 5/8"
- Supplied in sturdy PRO-STACK case (combinable with TSTAK) with charger, multifunctional bracket, laser glasses and target card, remote control, receiver

CODE	DESCRIPTION				PRICE
FMHT77448-1	FATMAX RL750LG Rotary Laser Li-ion - Green	-	1	3 253561 774485	

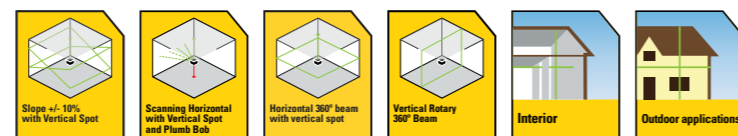

FATMAX® RL700L ROTARY LASER LI-ION - RED

STANLEY
FATMAX



- Lines: Rotary, point up and down
- Laser class: Red, Class 2
- Operating range: 60m - 600m with receiver
- Accuracy: $\pm 1.5 \text{ mm} @ 30 \text{ m (H)} \pm 3 \text{ mm} @ 30 \text{ m (V)}$
- Accuracy Point: $\pm 3 \text{ mm} @ 30 \text{ m (up)} \pm 8.7 \text{ mm} @ 30 \text{ m (down)}$
- RPM: 0-150-300-600
- Self-leveling range: $5^\circ \pm 1^\circ$ (any direction)
- Leveling Time (seconds): $\leq 30 \text{ s}$
- Double slope: 10°
- Scan mode
- IP66 dust and water resistant
- Tilt function
- Lithium Ion battery, 3.7V, 5.0Ah 40 hours
- Thread: 5/8"
- Supplied in sturdy PRO-STACK case (combinable with TSTAK) with charger, multifunctional bracket, laser glasses and target card, remote control, receiver

CODE	DESCRIPTION				PRICE
FMHT77447-1	FATMAX RL700L Rotary Laser Li-ion - Red	-	1	3 253561 774478	

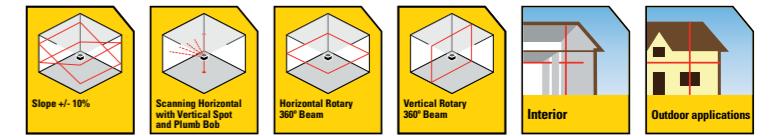

FATMAX® RL600L ROTARY LASER LI-ION - RED

STANLEY
FATMAX



- Lines: Rotary, point up
- Laser class: Red, Class 2
- Operating range: 60m - 600m with receiver
- Accuracy: $\pm 2.2 \text{ mm} @ 30 \text{ m (H)} \pm 3 \text{ mm} @ 30 \text{ m (V)}$
- Accuracy Point: $\pm 4.4 \text{ mm} @ 30 \text{ m}$
- RPM: 0-150-300-600
- Self-leveling range: $5^\circ \pm 1^\circ$ (any direction)
- Leveling Time (seconds): $\leq 30 \text{ s}$
- IP66 dust and water resistant
- Tilt function
- Lithium Ion battery, 3.7V, 5.0Ah 40 hours
- Thread: 5/8"
- Supplied in sturdy PRO-STACK case (combinable with TSTAK) with charger, laser glasses and target card, remote control, receiver

CODE	DESCRIPTION				PRICE
FMHT77449-1	FATMAX RL600L Rotary Laser Li-ion - Red	-	1	3 253561 774492	

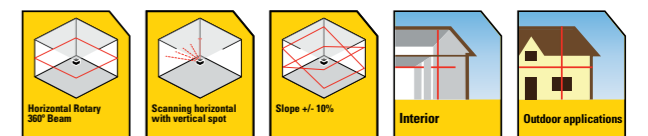

FATMAX® RL600 ROTARY LASER ALKALINE - RED

STANLEY
FATMAX



- Lines: Rotary, point up
- Laser class: Red, Class 2
- Operating range: 60m - 600m with receiver
- Accuracy: ± 2.2 mm @ 30 m (H) ± 3 mm @ 30 m (V)
- Accuracy Point: ± 4.4 mm @ 30 m
- RPM: 0-150-300-600
- Self-leveling range: $5^\circ \pm 1^\circ$ (any direction)
- Leveling Time (seconds): ≤ 30 s
- IP54 dust and water resistant
- Tilt function
- Thread: 5/8"
- Supplied in sturdy PRO-STACK case (can be combined with TSTAK) with 2x D-cell (1.5V, 1.2Ah) batteries, laser glasses and target card, receiver



CODE	DESCRIPTION				PRICE
FMHT77446-1	FATMAX RL600 Rotary Laser Alkaline - Red	-	1		

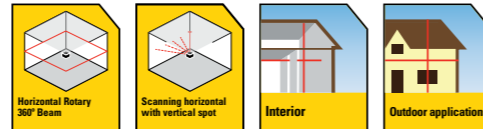

ROTARY LASER

STANLEY
FATMAX



- Range: 30 m (240 m with receiver)
- Accuracy: ± 6 mm @ 30 m H and ± 9 mm @ 30 m V
- IP54 dust and water resistant
- Tilt function
- Lockable pendulum for durable transport and can be used both horizontally and vertically
- Thread: 5/8"
- Supplied with 2x D batteries, laser goggles, laser target, detector and storage bag

CODE	DESCRIPTION				PRICE
STHT77616-0	Rotary Laser	X	2		



THE MEASURE OF A PRO™

LASER ACCESSORIES

MAGNETIC TARGET - RED



- Reflective plate with magnetic base
- Amplified laser beam for better visibility

CODE	DESCRIPTION				PRICE
1-77-170	Magnetic Target - Red*	-	2	2 5 3 5 6 1 7 7 1 7 0 5	

**Not in the Nordic assortment - special order required*

MAGNETIC TARGET - GREEN



- Reflective plate with magnetic base
- Amplified laser beam for better visibility

CODE	DESCRIPTION				PRICE
STHT1-77368	Magnetic Target - Green*	-	8	2 5 3 5 6 1 7 7 3 6 8 6	

**Not in the Nordic assortment - special order required*

LASER GOGGLES - RED



- Enhances the visibility of laser line or laser point

CODE	DESCRIPTION				PRICE
1-77-171	Laser Glasses - Red	-	1	2 5 3 5 6 1 7 7 1 7 1 2	

LASER GOGGLES - GREEN



- Enhances the visibility of laser line or laser point

CODE	DESCRIPTION				PRICE
STHT1-77367	Laser goggles - Green*	-	4	2 5 3 5 6 1 7 7 3 6 7 9	

**Not in the Nordic assortment - special order required*

ALUMINUM RULER



- Ruler directly readable with centered zero point
- Possible to immediately read height differences both positive and negative
- Extendable from 137 to 250 cm

CODE	DESCRIPTION				PRICE
06-TLM	Measuring rod 2.5 m	-	1	5 9 0 2 0 1 3 9 2 7 2 8 0	

ALUMINUM TELESCOPIC RULER



- 5 m and 5 parts: very durable
- in cm on the front, in mm on the back

CODE	DESCRIPTION				PRICE
1-77-161	Measuring rod Alu 5 m	-	2		76.15

INCLINE ADAPTER



- Gradation of angles - range from 0° to 90°
- Can be mounted on tripods 1-77-163 and 1-77-164 (threaded 5/8")

CODE	DESCRIPTION				PRICE
1-77-168	Adapter For Inclination Angle*	-	1		

*Not in the Nordic assortment - special order required

WALL BRACKET



- Wall mount for Rotary lasers
- Vertical applications possible thanks to side screw thread

CODE	DESCRIPTION				PRICE
1-77-172	Wall bracket for RL300 and RL100*	-	1		

*Not in the Nordic assortment - special order required

MINI TRIPOD



- 360° orientable
- Foldable supports with optimum stability thanks to non-slip feet

CODE	DESCRIPTION				PRICE
1-77-192	Mini Tripod*	-	1		

*Not in the Nordic assortment - special order required

ADAPTER 1/4" - 5/8"



CODE	DESCRIPTION				PRICE
1-77-128	Adapter 1/4" - 5/8"	-	1		

*Not in the Nordic assortment - special order required

PHOTO TRIPOD ALU



- Photo 3-foot with column for Laser distance Measurers and lasers
- 1/4" thread
- Adjustable height 44 to 119 cm, folded 47 cm

CODE	DESCRIPTION				PRICE
1-77-201	Photo Tripod	-	1		25.10

STAND 1/4"



- Aluminum tripod with column 1/4"
- Range: 97.15 cm - 247 cm and thread 1/4"

CODE	DESCRIPTION				PRICE
STHT77643-1	Tripod 1/4"	-	1		

TRIPOD TP1



- Aluminum tripod standard TP1
- Reach: 74.6 cm - 153 cm and thread 5/8"

CODE	DESCRIPTION				PRICE
STHT77625-1	Tripod TP1	-	1		

TRIPOD TPM1



- Reach up to 1.80 m and 5/8" thread
- Aluminum profile

CODE	DESCRIPTION				PRICE
1-77-131	Tripod TPM1	-	4		

ALUMINUM TRIPOD STANDARD TP1



- Aluminum profile
- Foot lock with Quick Clamps system
- Reach 0.97 m to 1.62 m and thread 5/8"

CODE	DESCRIPTION				PRICE
1-77-163	TP1 Tripod Alu 97-162 cm	-	2		

ALUMINUM TRIPOD WITH COLUMN TPE1



- Aluminum profile, double column
- Foot lock with Quick Clamps system
- Reach 1.02 m to 2.92 m and thread 5/8"

CODE	DESCRIPTION				PRICE
1-77-164	TPE1 Alu Tripod Extendable 119-292 cm*	-	1		

*Not in the Nordic assortment - special order required

LASER COLUMN WITH TRIPOD



- Reach 3.60 m

CODE	DESCRIPTION				PRICE
1-77-022	Laser column with tripod	-	1		

TELESCOPIC TRIPOD POLE



- Aluminum construction
- 4 piece tripod
- Suitable for all line lasers with 1/4" connection
- Reach 3.30 m

CODE	DESCRIPTION				PRICE
1-77-184	POLE Telescopic Alu Tripod	-	1		

TELESCOPIC TRIPOD WITH MAGNETIC BASE



- For height applications
- Easy adjustment up to 3 m
- Adjustable support
- Aluminum construction

CODE	DESCRIPTION				PRICE
1-77-221*	Telescopic Tripod 3 m with Magnetic Base	-	1		

*Not in the Nordic assortment - special order required

FATMAX® LASER CLAMP 5/8" AND 1/4"

STANLEY
FATMAX



- Clamping mechanism allows the laser clamp to be placed on horizontal structures
- The finely adjustable pivoting base allows fine adjustment of the laser and use of the plumb bob through the recess in the laser clamp
- Multifunctional laser clamp with a height adjustment of 20 cm, ideal for installing suspended ceilings
- 1/4" and 5/8" thread

CODE	DESCRIPTION				PRICE
FMHT1-77435	FATMAX Laser Clamp 5/8" and 1/4"	-	2		

RECHARGEABLE AA BATTERIES



- 4 pieces

CODE	DESCRIPTION				PRICE
1-77-135*	Rechargeable AA batteries	-	1		

*Not in the Nordic assortment - special order required

FATMAX® RLD400 ROTARY LASER LINE DETECTOR

STANLEY
FATMAX



- Receiver for Rotary lasers
- Range up to 600 m

CODE	DESCRIPTION	☐	☒	☐	PRICE
FMHT1-74266	FATMAX RLD400-G line detector for Rotary laser (green)	-	2	3	2 5 3 5 6 1 1 7 4 2 6 6 8
1-77-133	FATMAX RLD400 Rotary Laser Line Detector (Red)	-	1	3	2 5 3 5 6 1 1 7 7 1 3 3 0

STANLEY® FATMAX® DIGITAL ROTARY LINE DETECTOR

STANLEY
FATMAX



- Range/diameter: 300m/600m
- Accuracy: up to +/- 1 mm @ 40 m, 4 settings depending on the application
- Digital display window can be read from the front and back, with a large detection area +/- 50 mm to accurately detect the laser line
- Sound signal via 2 loudspeakers on the side and bottom, for correct levelling
- Memory function for receiving and holding heights at the touch of a button
- 2 strong magnets on side and top to attach to metal frames
- Rubber housing
- Dustproof and completely waterproof, IP66
- Supplied with 2x AA batteries

CODE	DESCRIPTION	☐	☒	☐	PRICE
FMHT77652-0	FATMAX Digital MM Receiver for Rotary Laser (Red)*	X	3	3	2 5 3 5 6 0 1 7 7 6 5 2 7
FMHT77653-0	FATMAX Digital MM Receiver for Rotary Laser (Green)*	X	3	3	2 5 3 5 6 0 1 7 7 6 5 3 4

*Not in the Nordic assortment - special order required

FATMAX® LD200 DIGITAL ROTARY LINE DETECTOR FOR CROSS LINE LASERS

STANLEY
FATMAX



- Receiver for cross line lasers
- Range up to 50 m

CODE	DESCRIPTION	☐	☒	☐	PRICE
FMHT1-74267	FATMAX LD200-G line detector for cross line lasers (green)	-	2	3	2 5 3 5 6 1 1 7 4 2 6 7 5
1-77-132	FATMAX LD200 line detector for cross line lasers (red)	-	1	3	2 5 3 5 6 1 1 7 7 1 3 2 3

STUD SENSORS

MOISTURE METER



- Measure moisture of building material from 0.2% to 2.0%
- Measure wood moisture from 6% to 44%
- Dual measuring scale, LCD display with bar graph
- Built-in battery for checking and verification measurement
- Automatic shut-off saves battery energy
- Battery operated for on-the-go power
- Shockproof housing
- Replaceable threaded probes
- Convenient pocket-sized device
- Complete with protective cover, including 3x CR-2-32 button batteries

CODE	DESCRIPTION	☐	☒	☐	PRICE
0-77-030	moisture meter	X	2	3	2 5 3 5 6 0 1 7 7 0 3 0 3

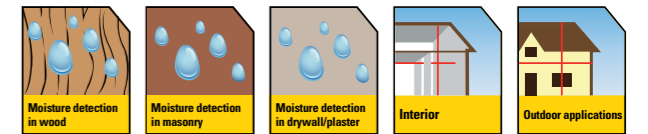

INTELLILASER PRO



- Multi-Line Laser with wall studs - and alternating current detector
- 6 m working range
- Automatic calibration
- Detects wood and metal stud edges up to 38mm depth and AC cables up to 51mm depth
- 180° rotatable laser head for vertical and horizontal levelling
- Audible alarm to indicate stud edge
- LCD backlight to see the center of the stud
- Supplied without batteries

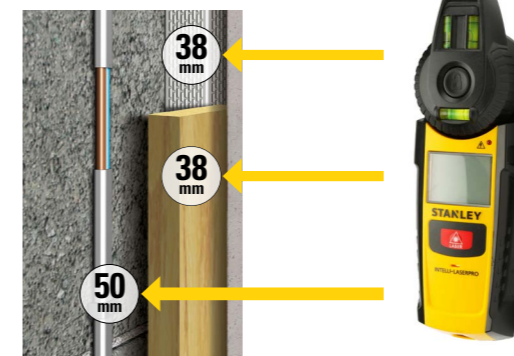

CODE	DESCRIPTION	☐	☒	☐	PRICE
0-77-260*	Intellilaser Pro	X	2	3	2 5 3 5 6 0 1 7 7 5 0 0 1

*Not in the Nordic assortment - special order required

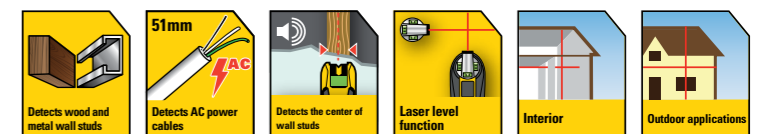

FATMAX® STUD SENSOR S300

STANLEY
FATMAX



- Detects wood and metal studs up to 38mm
- LCD display with center detector Audible/visual warning for connected AC wires
- Detects live AC wires up to 51mm
- Automatic calibration
- Soft-grip design
- Marking slot to mark the center
- Features a scan mode for accurate detection of ferrous metal to 75mm depth and 38mm for copper
- Extended model with LCD backlight for easy readability even in low light.
- LCD display with center detector
- Supplied without batteries

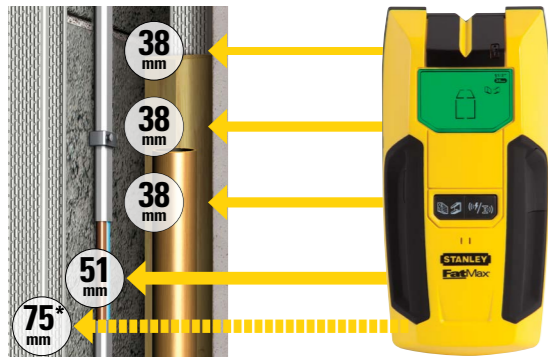

*ferrous metals only in scan mode

CODE	DESCRIPTION				PRICE
FMHT0-77407	FATMAX Stud Sensor S300	-	2	3 253560 774073	

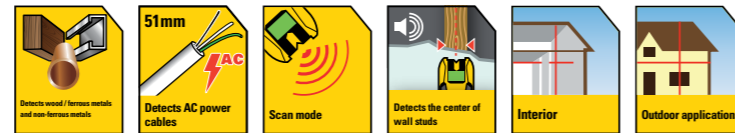

S160 STUD SENSOR



- Detects wood studs up to 25mm and metal studs up to 38mm
- Detects live electrical cables (230V) up to 50 mm
- Automatic calibration
- Detection and marking point for the center point of wood/metal wall studs
- Angular tolerance - fewer errors when used at an angle
- Audible and visual (LED) indication when detecting live electrical lines
- Ultra-compact design for easy storage
- Easy operation with 1 button
- Supplied with 2x AAA batteries



CODE	DESCRIPTION				PRICE
STHT77588-0	S160 Stud Sensor	X	4	3 253560 775889	

STUD SENSOR S200



- Compact and easy to use
- Detects wood/metal studs up to 19mm
- LCD display with center detector
- Audible/visual warning for connected AC wires
- Marker channel to mark the edge of the structure
- Automatic calibration
- Soft grip
- Supplied without batteries



CODE	DESCRIPTION				PRICE
STHT0-77406	Stud Sensor S200	-	2	3 253560 774066	

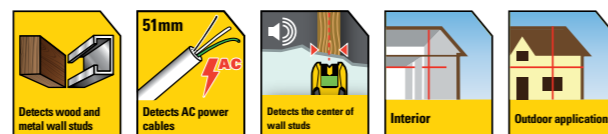

S110 STUD SENSOR



- Detects wood/metal studs up to 19mm
- Detects live electrical lines (230V) up to 50 mm
- Automatic calibration
- Detection and marking point for the center point of wood/metal wall studs
- Angular tolerance - fewer errors when used at an angle
- Audible and visual (LED) indication when detecting live electrical lines
- Ultra-compact design for easy storage
- Easy operation with 1 button
- Supplied with 2x AAA batteries

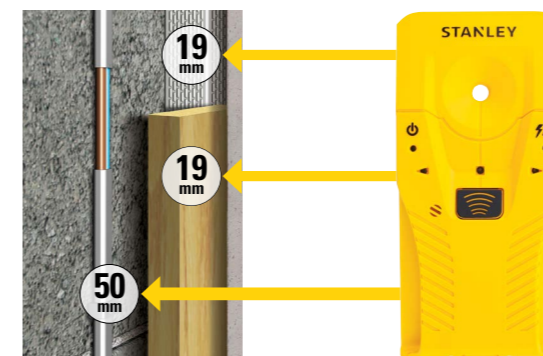

CODE	DESCRIPTION				PRICE
STHT77587-0	S110 Stud Sensor	X	4	3 253560 775872	

INSPECTION CAMERA

- Inspection Camera with 1m flexible tube for extended reach through most holes and behind most surfaces
- 8mm wide camera head for minimal surface damage and access to most cavities and crevices
- Brightness / Contrast control - Eight different levels of brightness provide maximum visibility in dark environments
- Color LCD Monitor - size 2.31", 64x48 pixels
- Water and dust resistance: IP67. Camera wall can withstand extreme conditions in the workplace
- LED light on the sensor for extra visibility
- Rotary Image Positions - rotate the display to get the best possible angle when viewing inaccessible surfaces
- Supplied with 4x AA batteries



CODE	DESCRIPTION				PRICE
STHT0-77363	Inspection camera	X	2		



FATMAX® IR THERMOMETER

**STANLEY
FATMAX**



- Thermal leak detection - from a reference temperature (green screen), scanning an area will show a red screen for higher temperature detection and blue screen for lower temperature
- Optics 20:1, allows users to measure a 32 cm circle from 2.5 m away
- Accuracy of 2% or +/- 2 degrees - for extremely accurate measurements
- Contrast backlit display - ensures visibility in all lighting conditions
- Temperature range from -50° to 1350°C - wide range allows users to effectively complete desired tasks
- Unit of measurement: Fahrenheit / Celsius
- Emission of 0.95 and response time of 1 second
- IP 20 for protection against dust
- Rubber non-slip housing
- Supplied in a sturdy case, including 9V battery

CODE	DESCRIPTION				PRICE
FMHT0-77422	FATMAX IR Thermometer	X	2		

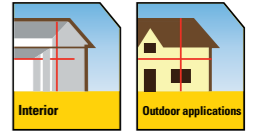

THERMOMETER



- Infrared thermometer
- Thermal leak detection - from a reference temperature (green screen), scanning an area will show a red screen for higher temperature detection and blue screen for lower temperature
- Optics 8:1, allows users to measure a 32 cm circle from 2.5 m away
- Accuracy of 2% or +/- 2 degrees - for extremely accurate measurements
- Contrast backlit display - ensures visibility in all lighting conditions
- Temperature range from -38° to 520°C - wide range allows users to effectively complete desired tasks
- IP 20 for protection against dust
- Supplied with wristband and 9V battery

CODE	DESCRIPTION				PRICE
STHT0-77365	Thermometer	X	2		

WALL PLUG TESTER



- Quickly check the wall plug status
- Quick diagnostic / time saving by not dismantling the wall plug
- Easy to use and compact
- LED Indicate Condition of the wiring (Correct, Missing Earth, Live-Earth Reverse, Live-Neutral Reverse, Missing Neutral)

CODE	DESCRIPTION				PRICE
FMHT82569-6	Wall Plug Tester	X	20	3253566825694	

MULTI-METERS

FATMAX® MULTI-METER

STANLEY
FATMAX



- Voltage AC / DC :600V
- Continuity: $\leq 30\Omega$
- Current: C/DC: 10A
- Resistance: 40M Ω
- Diode check 3.0V/0.8mA
- Multi-meter with 7 functions
- cat III

CODE	DESCRIPTION				PRICE
FMHT0-77419	FATMAX Multi-meter*	X	2		

*Not in the Nordic assortment - special order required

FATMAX® DIGITAL MULTI-METER SMART

STANLEY
FATMAX



- Dual display - ability to keep 2 values on screen at the same time
- Illuminated screen
- "Hold" function - allows to hold a value for a few seconds
- Smart function automatically detects the correct measurement
- Max min measurement
- Strong housing
- NCV (Non contact voltage)
- Supplied with 2x AAA batteries

CODE	DESCRIPTION				PRICE
FMHT82563-0	FATMAX Digital Multi-meter SMART	X	2		

FATMAX® DIGITAL MULTI-METER SMART CLAMP

STANLEY
FATMAX



- Clamp meter - Multi-meter measures current up to 600A
- Dual display - ability to keep 2 values on screen at the same time
- "Hold" function - allows to hold a value for a few seconds
- Smart function automatically detects the correct measurement
- Max min measurement
- Strong housing
- NCV (Non contact voltage)
- Supplied with 3x AAA batteries

CODE	DESCRIPTION				PRICE
FMHT82564-0	FATMAX Digital Multi-meter SMART CLAMP	X	2		

FATMAX® DIGITAL MULTI-METER

STANLEY
FATMAX



- Single display
- "Hold" function - allows to hold a value for a few seconds
- AC/DC A & V measurements
- Strong housing
- Continuity $\leq 30\Omega$
- Supplied with 2x AAA batteries

CODE	DESCRIPTION				PRICE
FMHT82565-0	FATMAX Digital Multi-meter	X	2		

MULTI-METER

- Multi-meter with 7 functions and 2 measuring units
- Battery Tester - Tests AAA, AA, C, D, 1.5 volt, button cell and 9 volt batteries
- Current DC: 200 μ / 2000 μ / 20m / 200m / 10A
- Diode Check: 2.8V / 1mA
- Resistance: 200/2000 / 20k / 200k / 2000k Ω
- Temperature: 0~1000
- AC voltage: 200 / 300V
- DC voltage: 200m / 2000m / 20/200 / 300V
- Continuity: $\leq 30\Omega$
- Cat III safety established - suitable for Category 3 standards
- Rugged molded housing, shock resistant and comfortable ergonomic design
- LCD display, large digits for easy reading
- Fold-out foot at the back of the device for hands-free use of the device



CODE	DESCRIPTION				PRICE
STHT0-77364	Multi-meter	X	2		

FATMAX® VOLT TESTER

STANLEY
FATMAX



- LED display - measured value can be read immediately on the display
- Polarity indication
- Earth leakage protection
- IP54

CODE	DESCRIPTION				PRICE
FMHT82566-0	FAMAX Volt tester	X	5		

STANLEY® FATMAX® NON CONTACT METAL AND VOLTAGE DETECTOR

STANLEY
FATMAX



- "Non contact" AC Voltage detector
- Allows to measure voltage without contact
- Metal detection $\leq 20\text{ mm}$
- AC Voltage Range: 20V~1000V
- Operates on 1x 12V A23 battery (not included)

CODE	DESCRIPTION				PRICE
FMHT82567-0	STANLEY® FATMAX® Non Contact Metal and Voltage Detector	X	5		

THE MEASURE OF A PRO™



HAMMERS

Designed for the professional, STANLEY® hammers feature specific heads and weights for building and demo along with secure grips, and fatigue-reducing handles.

We've carried out extensive research when developing our latest range of ANTIVIBE™ hammers. New vibration dampening technology ensures ultimate protection against hand and arm stress and yet delivers more striking power than traditional designs. The unique ANTIVIBE™ collars absorb potentially harmful shockwaves transferring additional power into every strike. Giving you the ultimate power and control.



FATMAX® HAMMER

Performance from within

We have conducted extensive research to develop ANTIVIBE™ hammers. Thanks to the new technology to dampen vibrations, your hands and arms are optimally protected against shocks. And yet you have more power than with traditional hammers. So you get the ultimate power and control - in every strike.

ANTIVIBE™ HAMMERS



THE IDEAL COMBINATION OF POWER AND COMFORT

Head and core are made from 1 single piece.
 Thermal treatment of the impact area prevents wear.
 Exceptional durability head with enlarged hitting area
 Exclusive tuning fork shock absorber system for very good protection against shocks.
 Ergonomic handle in flexible polyurethane coating for optimal grip and perfect balance.

Comparative analysis of the dampening effect

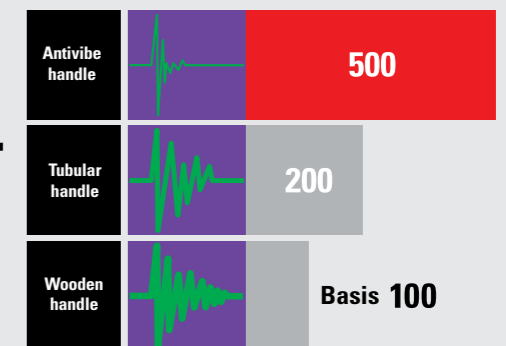

ANTIVIBE SYSTEM

This system has been specially developed to reduce vibrations and thus also reduces user fatigue.

COMPO-CAST HAMMERS

NO RECOIL

Small steel balls in the head of the hammer ensure that the hammer does not bounce back after the strike.

NO SPARKS

No part of the metal is left unprotected, which allows the hammers to be used in places where even the smallest spark could cause an explosion.

SHOCKPROOF

The head and metal handle are completely covered with a thick layer of urethane to protect tools and surfaces from hammer impact.

DURABILITY

The handle is soldered to the head for longer life. Solid steel shaft for reinforcement.

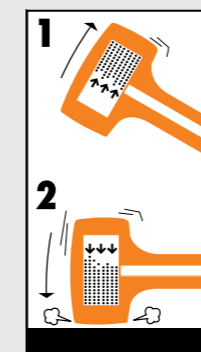

With each hit, the metal balls moves to absorb vibrations, avoid recoil, and improve control.

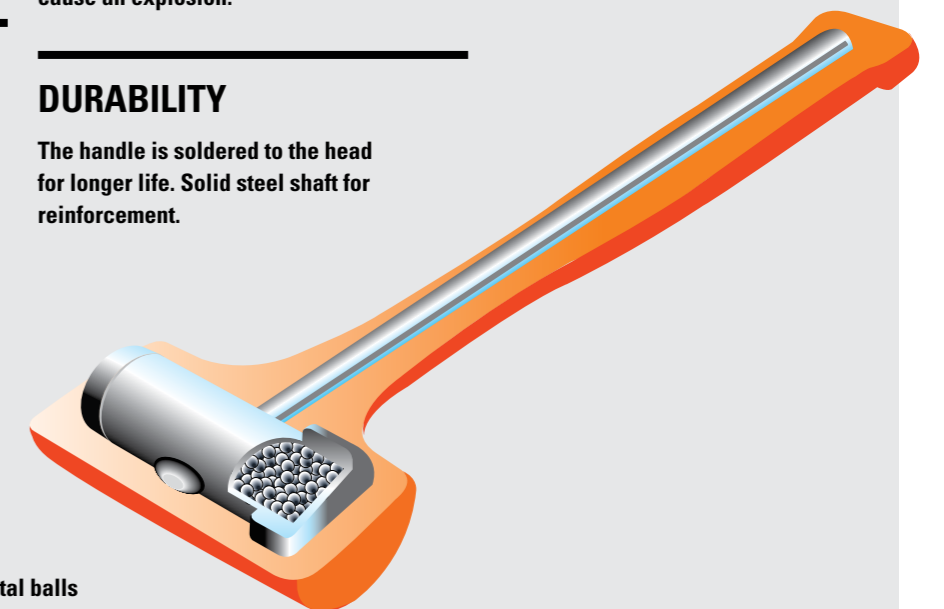



GLASSFIBER HAMMER

The longer handle and fiberglass shaft provide even better performance and durability.

CLAW HAMMERS

FATMAX® PRO ULTRA-LIGHT CURVED CLAW HAMMER

STANLEY
FATMAX

- Patented MIG (Metal Inert Gas) welding technology makes the hammer 40% lighter
- 100% steel for strength and durability
- New light weight (390 gr) design
- Exclusive dual tempered head rims & claw reduces steel chipping
- Magnetic nail starter for hands free use
- This hammer combines the weight of titanium with the strength of steel



CODE	DESCRIPTION				PRICE
XTH1-51148	FATMAX Pro Ultra-light Claw Hammer	-	4		

FATMAX® PRO ULTRA-LIGHT CURVED CLAW HAMMER - STRAIGHT CLAW

STANLEY
FATMAX

- Patented MIG (Metal Inert Gas) welding technology makes the hammer 40% lighter
- 100% steel for strength and durability
- New light weight (390 gr) design
- Exclusive dual tempered head rims & claw reduces steel chipping
- Magnetic nail starter for hands free use
- This hammer combines the weight of titanium with the strength of steel



CODE	DESCRIPTION				PRICE
XTH1-51123	FATMAX Pro Ultra-light Claw Hammer*	-	4		

*Not in the Nordic assortment - special order required

FATMAX® CURVED CLAW HAMMER NEXT GENERATION

STANLEY
FATMAX

- Patented Over-Sized Strike Face 25% larger "Sweet Spot"
- Patented AntiVibe™ hammer
- Renewed design and softer hammer
- Accurately balanced head
- AntiVibe™ Proprietary Tuning Fork Designed to reduce vibration and arm fatigue



CODE	DESCRIPTION				PRICE
FMHT1-51275	FATMAX Curved Claw Hammer AntiVibe Next Gen 450gr	X	4		
FMHT1-51277	FATMAX Curved Claw Hammer AntiVibe Next Gen 570gr	X	4		

FATMAX® CLAW HAMMER NEXT GEN - STRAIGHT CLAW

STANLEY
FATMAX



- Patented Over-Sized Strike Face 25% larger "Sweet Spot"
- Patented AntiVibe™ hammer
- Renewed design and softer hammer
- Accurately balanced head
- AntiVibe™ Proprietary Tuning Fork Designed to reduce vibration and arm fatigue

CODE	DESCRIPTION				PRICE
FMHT1-51276	FATMAX Claw Hammer AntiVibe Next Gen 450gr - Straight Claw	X	4	3	2 5 3 5 6 1 5 1 2 7 6 6
FMHT1-51278	FATMAX Claw Hammer AntiVibe Next Gen 570gr - Straight Claw	X	4	3	2 5 3 5 6 1 5 1 2 7 8 0

CURVED CLAW HAMMER FIBERGLASS



- Bi-material non-slip hammer
- Longer Hammer for improved performance
- Overstrike protection for added durability
- Fiberglass handle for strength & durability
- Epoxy bonded head provides tough connection to ensure no separation during normal use

CODE	DESCRIPTION				PRICE
STHT0-51309	Claw hammer Fiberglass 450gr	-	4	3	2 5 3 5 6 0 5 1 3 0 9 2
STHT0-51310	Claw hammer Fiberglass 560gr	-	4	3	2 5 3 5 6 0 5 1 3 1 0 8

CLAW HAMMER STEELMASTER™



- Tempered steel head for strength, durability and safety
- Tempered head edge –for durability and safety
- Ergonomically shaped Hammer (DynagGrip® Pro) – for comfortable grip and more safety
- Connection of head and Hammer - withstands a 5 ton impact
- Tubular oval shaft combines strength with a lightweight feel

CODE	DESCRIPTION				PRICE
1-51-031	Claw hammer Steelmaster 450gr	-	4	5	0 0 0 3 6 6 5 1 0 3 1 6
1-51-033	Claw hammer Steelmaster 570gr	-	4	5	0 0 0 3 6 6 5 1 0 3 3 0

CLAW HAMMER BLUE STRIKE



- Tempered and forged head for strength and durability
- Tubular oval shaft combines strength with a lightweight feel

CODE	DESCRIPTION				PRICE
1-51-488	Claw hammer Blue Strike 450gr	-	6	3	2 5 3 5 6 1 5 1 4 8 8 3
1-51-489	Claw hammer Blue Strike 570gr	-	6		3253561514890

BLACKSMITH HAMMERS

BLACKSMITH HAMMER FIBERGLASS



- Bi-material non-slip hammer
- Longer hammer for improved performance
- Overstrike protection for added durabilityFiberglass handle for strength & durability
- Epoxy bonded head provides tough connection to ensure no separation during normal use

CODE	DESCRIPTION				PRICE
STHT0-54158	Blacksmith Hammer Fiberglass 160gr	-	4	3	2 5 3 5 6 0 5 4 1 5 8 3
STHT0-54159	Blacksmith Hammer Fiberglass 315gr	-	4	3	2 5 3 5 6 0 5 4 1 5 9 0
STHT0-54160	Blacksmith Hammer Fiberglass 500gr	-	4	3	2 5 3 5 6 0 5 4 1 6 0 6

BLACKSMITH HAMMER WOOD



- Ash wood hammer (high quality) for durability and balance
- Tempered steel head for strength, durability and safety
- Flat head with chamfered corners gives strength and prevents damage
- Unbreakable hammer thanks to super strong connection of head and Hammer - for more safety
- DIN 6475

CODE	DESCRIPTION				PRICE
1-54-638	Blacksmith Hammer Wood 100gr*	-	4	3	2 5 3 5 6 1 5 4 6 3 8 9
1-54-641	Blacksmith Hammer Wood 315gr*	-	4	3	2 5 3 5 6 1 5 4 6 4 1 9
1-54-642	Blacksmith Hammer Wood 400gr*	-	4	3	2 5 3 5 6 1 5 4 6 4 2 6
1-54-643	Blacksmith Hammer Wood 500gr*	-	4	3	2 5 3 5 6 1 5 4 6 4 3 3

*Not in the Nordic assortment - special order required

LOCKSMITH HAMMERS

LOCKSMITH HAMMER FIBERGLASS



- Bi-material hammer
- Longer hammer for improved performance
- Overstrike protection for added durability
- Fiberglass handle for strength and durability
- Epoxy bonded head provides tough connection to ensure no separation during normal use

CODE	DESCRIPTION				PRICE
STHT0-51906	Locksmith hammer Fiberglass 200gr	-	4	3	2 5 3 5 6 0 1 5 1 9 0 6 3
STHT0-51907	Locksmith hammer Fiberglass 300gr	-	4	3	2 5 3 5 6 0 1 5 1 9 0 7 0
STHT0-51908	Locksmith hammer Fiberglass 500gr	-	4	3	2 5 3 5 6 0 1 5 1 9 0 8 7
STHT0-51909	Locksmith hammer Fiberglass 800gr	-	4	3	2 5 3 5 6 0 1 5 1 9 0 9 4
STHT0-51910	Locksmith hammer Fiberglass 1000gr	-	4	3	2 5 3 5 6 0 1 5 1 9 1 0 0

LOCKSMITH HAMMER FIBERGLASS



- Bi-material non-slip hammer
- Longer hammer for improved performance
- Overstrike protection for added durability
- Fiberglass handle for strength & durability
- Epoxy bonded head provides tough connection to ensure no separation during normal use

CODE	DESCRIPTION				PRICE
STHT0-54129	Locksmith hammer Fiberglass 200gr	-	4	3	2 5 3 5 6 0 1 5 4 1 2 9 3
STHT0-54131	Locksmith hammer Fiberglass 300gr	-	4	3	2 5 3 5 6 0 1 5 4 1 3 1 6
STHT0-54154	Locksmith hammer Fiberglass 500gr	-	4	3	2 5 3 5 6 0 1 5 4 1 5 4 5
STHT0-54155	Locksmith hammer Fiberglass 800gr	-	2	3	2 5 3 5 6 0 1 5 4 1 5 5 2
STHT0-54156	Locksmith hammer Fiberglass 1000gr	-	2	3	2 5 3 5 6 0 1 5 4 1 5 6 9
STHT0-54157	Locksmith hammer Fiberglass 1250gr	-	2	3	2 5 3 5 6 0 1 5 4 1 5 7 6

LOCKSMITH HAMMER WOOD



- Ash wood hammer (high quality) for durability and balance
- Tempered steel head for strength, durability and safety
- Flat head with chamfered corners provides strength and prevents damage
- Unbreakable hammer thanks to super strong connection of head and hammer - for more safety

CODE	DESCRIPTION				PRICE
1-51-171	Locksmith Hammer Wood 100gr*	-	4	3	2 5 3 5 6 1 1 5 1 1 7 1 4
1-51-172	Locksmith Hammer Wood 200gr	-	4	3	2 5 3 5 6 1 1 5 1 1 7 2 1
1-51-173	Locksmith Hammer Wood 300gr	-	4	3	2 5 3 5 6 1 1 5 1 1 7 3 8
1-51-174	Locksmith Hammer Wood 400gr*	-	4	3	2 5 3 5 6 1 1 5 1 1 7 4 5
1-51-175	Locksmith Hammer Wood 500gr*	-	4	3	2 5 3 5 6 1 1 5 1 1 7 5 2
1-51-178	Locksmith Hammer Wood 800gr*	-	2	3	2 5 3 5 6 1 1 5 1 1 7 8 3

*Not in the Nordic assortment - special order required

CLUB HAMMERS

CLUB HAMMER FIBERGLASS



- Bi-material non-slip club
- Longer club for improved performance
- Overstrike protection for added durability
- Fiberglass handle for strength & durability
- Epoxy bonded head provides tough connection to ensure no separation during normal use

CODE	DESCRIPTION				PRICE
STHT0-54126	Club hammer Fiberglass 1000gr	-	2	3	2 5 3 5 6 0 1 5 4 1 2 6 2
STHT0-54127	Club hammer Fiberglass 1250gr	-	2	3	2 5 3 5 6 0 1 5 4 1 2 7 9
STHT0-54128	Club hammer Fiberglass 1500gr	-	2	3	2 5 3 5 6 0 1 5 4 1 2 8 6

CLUB HAMMER WOODEN



- Ash wood club (high quality) for durability and balance
- Tempered steel head for strength, durability and safety
- Flat head with chamfered corners gives strength and prevents damage
- Unbreakable club thanks to super strong connection of head and club - for more safety

CODE	DESCRIPTION				PRICE
1-54-051	Club 1000gr	-	2	3	2 5 3 5 6 1 1 5 4 0 5 1 6
1-54-052	Club 1250gr	-	2	3	2 5 3 5 6 1 1 5 4 0 5 2 3
1-54-053	Club 1500gr	-	2	3	2 5 3 5 6 1 1 5 4 0 5 3 0

CONSTRUCTION HAMMERS

RHINE TUBULAR STEELMASTER HAMMER



- Tempered steel head for strength and durability
- Ergonomically shaped hammer (Dynagrip® Pro) – for comfortable grip and more safety
- 5 ton force fit head to handle assembly for improved safety
- Sharp chisel for cutting bricks and slate

CODE	DESCRIPTION				PRICE
1-51-039	Rhine tubular steelmaster hammer 500gr	-	6	3	2 5 3 5 6 1 1 5 1 0 3 9 7

COFFREUR HAMMER 750GR



- Bi-material non-slip hammer
- Longer club for improved performance
- Overstrike protection for added durability
- Fiberglass handle for strength & durability
- Epoxy bonded head provides tough connection to ensure no separation during normal use

CODE	DESCRIPTION				PRICE
STHT0-54123	Coffreur hammer 750gr	-	2	3	2 5 3 5 6 0 1 5 4 1 2 3 1

LATH HAMMER FIBERGLASS 600GR



- Bi-material grip non-slip lath hammer
- Longer hammer for improved performance
- Overstrike protection for added durability
- Fiberglass handle for strength & durability
- Epoxy bonded head provides tough connection to ensure no separation during normal use

CODE	DESCRIPTION				PRICE
STHT0-51311	Lath hammer Fiberglass 600gr	-	6	3	2 5 3 5 6 0 1 5 1 3 1 1 5

LATH HAMMER ANTIVIBE 600GR



- Flexible ergonomic handle
- Head and handle forged in one part
- Heat treatment anti-glare of the zone of striking
- Flat squared head
- Patented AntiVibe™ hammer

CODE	DESCRIPTION				PRICE
1-51-937	Lath hammer Antivibe 600gr	-	6		3253561519376

LATH HAMMER STEEL



- Tempered and forged head with flat surface for better results
- Connection of head and hammer - withstands a 5 ton impact
- Chrome plated tubular handle and moulded anatomical handle
- Magnetic nail starter for hands free use
- Protruding claw, to pierce slate before driving the nail through
- Ergonomically shaped hammer (Dynagrip® Pro) – for comfortable grip and more safety
- DIN 7239

CODE	DESCRIPTION	☐	☒	☐	PRICE
1-51-037	Lath hammer 600gr	-	2	3 2535611510373	

FATMAX® DEMOLITION HAMMER 620GR

STANLEY
FATMAX



- Demolition hammer of 620g that is suitable for removing floor panels, plates and plasterboard, for example
- Large striking surface for everyday nail applications
- Claw designed for 2x4 lumber
- Made in one piece
- Longer hammer for optimum demolition performance
- Ergonomic grip for comfort and vibration dampening

CODE	DESCRIPTION	☐	☒	☐	PRICE
FMHT51367-2	FATMAX Demolition hammer 620gr*	-	4	3 25356211513670	

*Not in the Nordic assortment - special order required

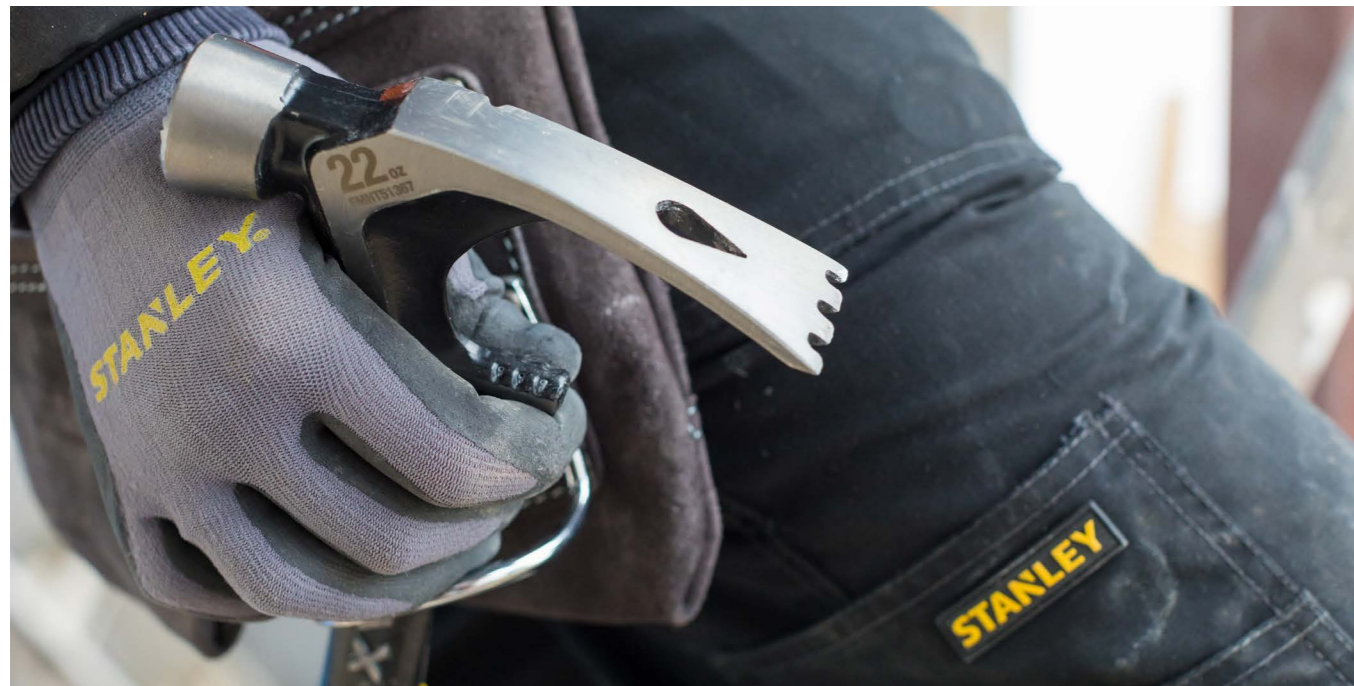

SLEDGEHAMMER

The power when you need it

STANLEY sledge hammers delivers the ultimate striking force with minimum effort. We combined the very latest ANTIVIBETM technology and glass fibre handle designs with a specially shaped bullet head for maximum performance. You can now get the job done quicker. And use less effort than with competitor hammers.

SPECIALITY HAMMERS

FATMAX® SLEDGEHAMMER ANTI-VIBRATION

STANLEY
FATMAX



- Fiberglass core absorbs vibrations and impact shock
- Polypropylene layer for impact protection
- FatMax AntiVibe shock absorbing layer that helps reduce vibrations in the handle
- Forged hammer head permanently bonded to the handle for durability with bullet nose design provides 2x more concentrated striking force

CODE	DESCRIPTION	☐	☒	☐	PRICE
FMHT1-56010	FATMAX Sledgehammer Anti-vibration 2.7kg	X	2	3	2 5 3 5 6 1 1 5 6 0 1 0 1
FMHT1-56011	FATMAX Sledgehammer Anti-vibration 3.6kg	X	2	3	2 5 3 5 6 1 1 5 6 0 1 1 8
FMHT1-56019	FATMAX Sledgehammer Anti-vibration 4.5kg	X	2	3	2 5 3 5 6 1 1 5 6 0 1 9 4

FATMAX® SLEDGEHAMMER ANTI-VIBRATION

STANLEY
FATMAX



- Fiberglass core absorbs vibrations and impact shock
- Polypropylene layer for impact protection
- FatMax AntiVibe shock absorbing layer that helps reduce vibrations in the handle
- Forged hammer head permanently bonded to the handle for durability with bullet nose design provides 2x more concentrated striking force

CODE	DESCRIPTION	☐	☒	☐	PRICE
FMHT1-56008	FATMAX Sledgehammer Anti-vibration 1814gr - with pointed nose	X	2	3	2 5 3 5 6 1 1 5 6 0 0 8 8
FMHT1-56009	FATMAX Sledgehammer Anti-vibration 1814gr *	X	2	3	2 5 3 5 6 1 1 5 6 0 0 9 5

**Not in the Nordic assortment - special order required*

ANTIVIBE™ CLUB HAMMER



- Club hammer for use in confined spaces with little room for full arc swing
- Applications include striking chisels, punches, and star-drills and many industrial applications

CODE	DESCRIPTION	☐	☒	☐	PRICE
1-56-001	AntiVibe Club Hammer 1360gr	-	4	3	2 5 3 5 6 1 1 5 6 0 0 1 9

CROSS PEEN HAMMER



- Quality hammer with ash shaft - keeps hammer in perfect balance for optimum performance

CODE	DESCRIPTION	☐	☒	☐	PRICE
1-54-077	Cross Peen hammer 100gr*	-	96	5	0 0 0 3 6 6 1 5 4 0 7 7 1

**Not in the Nordic assortment - special order required*

GRAPHITE BALL PEIN HAMMER



- 24 torque stabilizing bars
- Patented Anti-Vibe™ technology reduces vibration
- Bright colour accents, easy to find on work site
- Graphite core shaft for maximum strength
- One-piece forged construction for strength and durability
- Rim temper reduces likelihood of chipping when striking metal objects
- Shock dampening core
- Rim tempered poll and ball pein prevents chipping
- Rim temper reduces likelihood of chipping when striking metal objects
- Top of the hammer head is machined flat to allow it to stand upright on the shop floor or work bench

CODE	DESCRIPTION	☐	☒	☐	PRICE
1-54-716	Graphite Ball Pein hammer 450g	-	-	-	3253561547164

RUBBER/COMPO-CAST® HAMMERS

PLASTIC MALLET

- One-piece synthetic mallet with impact sockets
- For general use



CODE	DESCRIPTION				PRICE
1-57-053	Plastic mallet 320gr*	-	2	3 2 5 3 5 6 1 5 7 0 5 3 7	

*Not in the Nordic assortment - special order required

RUBBER MALLET

- Rubber head
- Wooden mallet
- For mechanical work



CODE	DESCRIPTION				PRICE
1-51-104*	Rubber Hammer 450gr	-	2	3 2 5 3 5 6 1 5 1 1 0 4 2	

*Not in the Nordic assortment - special order required

HAMMER/SLEDGE COMPO-CAST® STANDARD

- One-piece urethane hammer/sledge, prevents workpiece damage
- Head filled with steel balls that move on impact - absorbing recoil
- Not electrically conductive
- Spark-free



CODE	DESCRIPTION				PRICE
1-57-530	Hammer/sledge Compo-Cast 280gr	-	1	3 2 5 3 5 6 1 5 7 5 3 0 3	
1-57-531	Hammer/sledge Compo-Cast 500gr	-	1	3 2 5 3 5 6 1 5 7 5 3 1 0	
1-57-532	Hammer/sledge Compo-Cast 600gr	-	1	3 2 5 3 5 6 1 5 7 5 3 2 7	
1-57-533	Hammer/sledge Compo-Cast 1200gr	-	1	3 2 5 3 5 6 1 5 7 5 3 3 4	
1-57-534	Hammer/sledge Compo-Cast 1500gr	-	1	3 2 5 3 5 6 1 5 7 5 3 4 1	
1-57-550	Hammer/sledge Compo-Cast 2250gr	-	1	3253561575501	
1-57-552	Hammer/sledge Compo-Cast 4700gr	-	1	3253561575525	
1-57-554	Hammer/sledge Compo-Cast 5200gr	-	1	3253561575549	



DEMOLITION TOOLS

Stanley's demolition lineup is turning more than a few heads. Why? Because we make demolition tools that are more than just tough and strong. Our Wonder Bars[®] have been engineered to make pulling and prying easier. Stanley demolition bars are engineered with the professional in mind. They are forged from high-carbon steel with a trilobe design that can withstand up to 175kg-force meter of bending momentum.

PRACTICAL INFO

THE BEST DEMOLITION TOOLS

FUBARS

A unique tool from STANLEY for multiple purposes, available in multiple sizes. They can be used for prying, splitting, bending, hitting and nail pulling. The FATMAX FuBar should become an important part of any contractor's toolbox.



WONDER BARS

Extremely useful for prying, nail pulling and bending material and available in many sizes.



PRECISION BARS

Shorter bars for close up applications, including some with extra-wide lifting surfaces to spread the load. This allows you to gently lift and remove existing castings with minimal damage.



CROWBARS

FATMAX® PRO FUBAR™

STANLEY
FATMAX



- One-piece steel bar for added durability
- 4-in-1 tool for prying, splitting, board bending, and striking jobs
- Tempered face prevents chipping
- Double serrated jaws to grip wood and floor coverings
- Nail puller to pull out nails effortlessly

CODE	DESCRIPTION				PRICE
1-55-099	FATMAX Pro Fubar*	-	1	3 2 5 3 5 6 1 1 5 5 0 9 9 7	

*Not in the Nordic assortment - special order required

FATMAX® FUBAR II

STANLEY
FATMAX



- One-piece steel bar for added durability
- Hammer: 620 g
- Tempered face prevents chipping
- crowbar
- Nail puller
- Double serrated jaws to grip wood and floor coverings
- Ergonomic handle for excellent comfort and control

CODE	DESCRIPTION				PRICE
1-55-119	FATMAX Fubar II*	-	1	3 2 5 3 5 6 1 1 5 5 1 1 9 2	

*Not in the Nordic assortment - special order required

FATMAX® WONDER BAR

STANLEY
FATMAX



- Light weight
- Precision ground edge
- Wider pry bar for more leverage

CODE	DESCRIPTION				PRICE
1-55-516	FATMAX Wonder Bar 380mm	-	16	3 2 5 3 5 6 1 1 5 5 5 1 6 9	

WONDER BAR®



- Forged steel version for extra hardness
- Flattened corners for better operation
- Ideal for pulling nails, lifting or prying
- Flattened nail slot at the ends of the demolition bit

CODE	DESCRIPTION				PRICE
1-55-515	Wonder Bar 300mm	-	4	3 2 5 3 5 6 1 1 5 5 5 1 5 2	

SUPER WONDER BAR®



- Polished and grooved claws
- Groove for nail pulling and hanging
- Forged high carbon steel extra hardened for extra strength
- Curved shaft for use when lifting planks
- Yellow color for easier identification and loss prevention
- Polished claws at the right angle for nail removal in hard to reach places

CODE	DESCRIPTION				PRICE
1-55-525	Super Wonder Bar 400mm	-	4		

WONDER BAR® X21



- Polished and grooved claws
- Groove for nail pulling and hanging
- Forged high carbon steel extra hardened for extra strength
- Yellow color for easier identification and loss prevention
- Polished claws at the right angle for nail removal in hard to reach places

CODE	DESCRIPTION				PRICE
1-55-526	Wonder Bar 530mm	-	4		

FATMAX® FINE PRY BAR NARROW CLAW

STANLEY
FATMAX



- Polished and ground claw for precision work
- Bi-material non-slip handle
- Yellow finish for better visibility
- Flat face

CODE	DESCRIPTION				PRICE
FMHT1-55008	FATMAX Fine pry bar Narrow Claw 250 mm	X	2		
FMHT1-55010	FATMAX Fine pry bar Narrow Claw 300 mm	X	2		

FATMAX® FINE PRY BAR WIDE CLAW

STANLEY
FATMAX



- Polished and ground claw for precision work
- Bi-material non-slip handle
- Yellow finish for better visibility
- Flat face

CODE	DESCRIPTION				PRICE
FMHT1-55009	FATMAX Fine pry bar Wide Claw 250 mm	X	2		

PRY BAR FINE NARROW CLAW



- Polished and grooved claws for easier nail pulling
- Polished and grooved spatula for removing profiles

CODE	DESCRIPTION				PRICE
0-55-114	Pry bar Fine Narrow Claw 250 mm	X	2		

PRY BAR FINE BROAD CLAW



- Polished and grooved claws for easier nail pulling
- Polished and grooved spatula for removing profiles

CODE	DESCRIPTION				PRICE
0-55-116	Pry bar Fine Wide Claw 200 mm	X	2		
0-55-117	Pry bar Fine Wide Claw 250 mm	X	2		

THE MEASURE OF A PRO™



CLAMPS AND VICES

Clamps and vises come in all shapes and sizes and are meant for a variety of tasks, but they have some things in common. A good clamp or vise is easy to tighten and adjust; it holds securely; and it won't mar the surface it's clamped to. Stanley trigger clamps have three-times the travel of competitive clamps and can be adjusted with one hand. Our vises have roll-forged threads for precise adjustment and durability. Our F clamps have removable jaw pads to protect surfaces. Stanley offers a variety of clamps and vises so customers can match the size and shape to the job at hand.

PRACTICAL INFO

THE BEST CLAMPS FOR YOUR NEEDS

When making your choice, always keep in mind what you intend to do with the clamp and choose the size and performance accordingly – too heavy and too powerful and you may damage a fine work, too light and you can damage the clamp.

FATMAX® TRIGGER CLAMP

These provide the easiest and fastest adjustment and are ideal for clamping material on the workbench and for holding parts together during gluing. By reversing the jaws, they can be used to spread surfaces apart in a safe and controlled manner.



CORNER CLAMPS

Suitable for clamping one corner at a time. They have the advantage that they can be clamped on the workbench, so that both hands are free to make final adjustments.



C-CLAMPS

Forged from heavy duty malleable iron for added strength. They are used in the same situations as the 'F' clamps, but can handle a higher terminal load. 100 mm and 150 mm are the most convenient sizes.



SPRING CLIPS

Ideal for many small light tasks such as cloths, etc.





BAND CLAMP

A 4.5 m long nylon strap can be used to clamp any shape. Two clamps in combination with rigid rods make this clamp very powerful and offer a very large capacity. No additional tools are required to tension the clamp.









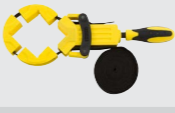

FATMAX® TRIGGER CLAMPS
Hold longer and tighter

CLAMPS AND VICES

TYPE	IMAGE	PRODUCT CODE	Weight (g)	Length (mm)	Throat Depth (mm)	Clamping Capacity (mm)	Spreading capacity (mm)	Clamping force (kg)
FATMAX® TRIGGER CLAMPS		FMHT0-83231			38	120	195	15
		FMHT0-83232			76	150	270	63
		FMHT0-83233			76	300	420	63
		FMHT0-83234			78	150	330	135
		FMHT0-83235			78	300	480	135
		FMHT0-83211			78	450	1080	135
		FMHT0-83213			90	450	690	270
		FMHT0-83236			78	600	780	135
		FMHT0-83237			78	900	1080	135
		FMHT0-83238			90	150	390	270
		FMHT0-83239			90	300	540	270
		FMHT0-83240			90	600	840	270
		FMHT0-83241			90	900	1140	270
		FMHT0-83242			90	1250	1490	270
FATMAX® CLUTCH LOCK F CLAMP		FMHT0-83244				200		
		FMHT0-83245				400		
		FMHT0-83246				600		
		FMHT0-83247				800		

CLAMPS AND VICES

TYPE	IMAGE	PRODUCT CODE	Weight (g)	Length (mm)	Throat Depth (mm)	Clamping Capacity (mm)	Spreading capacity (mm)	Clamping force (kg)
MAXSTEEL "C" CLAMPS		0-83-033	670	75	57			680
		0-83-034	980	100	75			680
		0-83-035	1820	150	89			680
		0-83-036	2534	200	100			1000
SPRING CLAMPS		STHT0-83199				50		
		STHT0-83200				100		
METAL SPRING CLAMPS		9-83-079	77			25		
		9-83-080	198			50		
BAILEY BAND CLAMP		0-83-100	465			450		
BAILEY CORNER CLAMP		0-83-121	275		15	75		
BAILEY CORNER CLAMP		0-83-122	1010		30	57		
MULTI-ANGLE BASE VISE 360°		1-83-069	1600		40	70		25
MAXSTEEL VISE		1-83-065	6000		85	100		1100
MAXSTEEL VISE HEAVY DUTY APPLICATIONS		1-83-066	13000		85	100		1400
		1-83-067	18000		95	125		1800
		1-83-068	27000		105	150		2200

CLAMPS AND VICES

TYPE	IMAGE	MATERIAL				APPLICATIONS							
		Wood	Steel	Soft materials	Synthetic material	Support for fixing, screwing, gluing	Ear function (ribbed steel equipment)	Mounting on work tables	To make furniture	Adhesive applications	Adhesive applications	90° clamping applications	Framework
FATMAX® TRIGGER CLAMPS		**	**	**	**	●	●	●	●	●	●		
FATMAX® CLUTCH LOCK F CLAMP		**	**	**	**	●	●	●	●	●			
MAXSTEEL "C" CLAMP		**	**	**	**	●	●	●	●	●			
SPRING CLAMP		*	**	*	*	●	●	●	●	●			
SPRING CLAMP		*	***	*	*				●	●			
BAILEY BAND CLAMP		***		***				●	●			●	
BAILEY CORNER CLAMP		***		*					●		●	●	
BAILEY CORNER CLAMP		***		***					●		●	●	
MULTI-ANGLE BASE VISE 360°		*	***			●							
BANKSCHROEF		*	***	*		●							

CLAMPS AND VICES

FATMAX® TRIGGER CLAMP

STANLEY
FATMAX

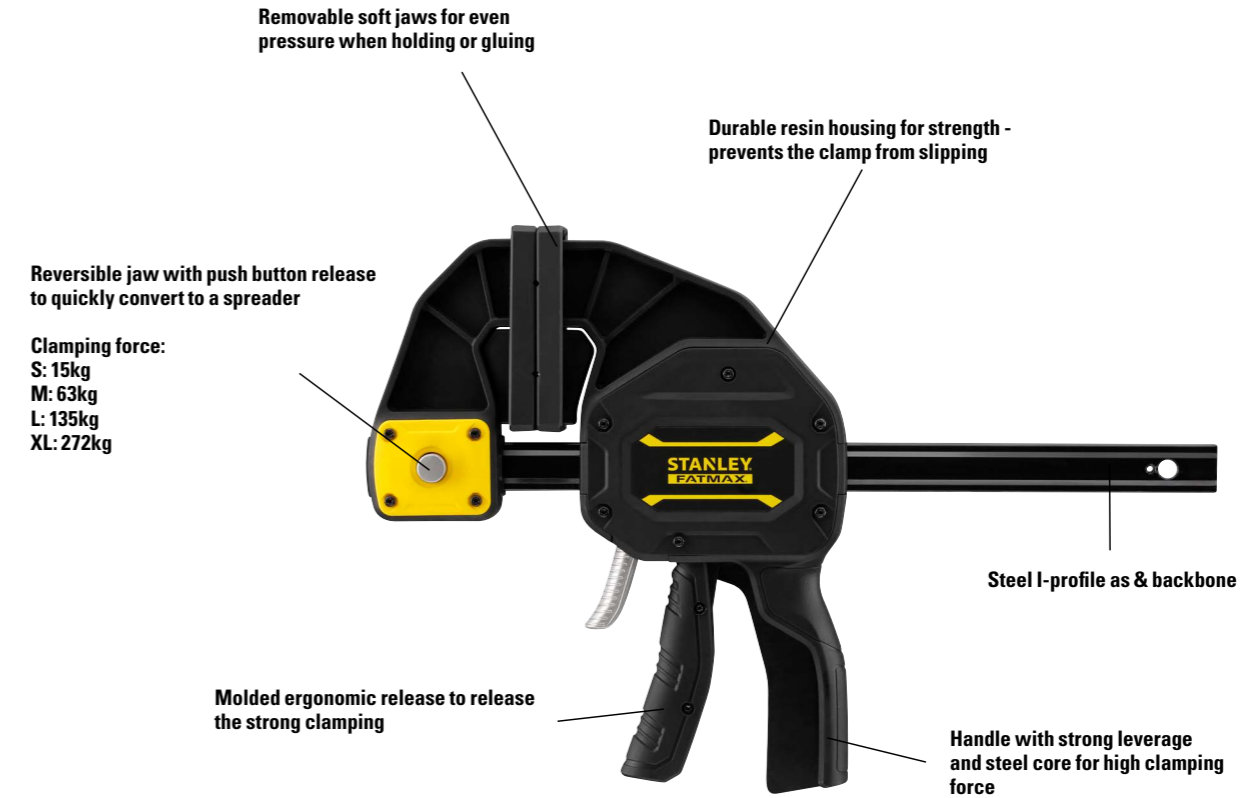

FMHT0-83243
Trigger Clamp 4-pack



CODE	DESCRIPTION	📧	📦	📊	PRICE
FMHT0-83231	FATMAX S Trigger clamp - 120mm	-	6	3 253560 832315	
FMHT0-83232	FATMAX M Trigger clamp - 150mm	-	4	3 253560 832322	
FMHT0-83233	FATMAX M Trigger clamp - 300mm	-	4	3 253560 832339	
FMHT0-83234	FATMAX L Trigger clamp - 150mm	-	4	3 253560 832346	
FMHT0-83235	FATMAX L Trigger clamp - 300mm	-	4	3 253560 832353	
FMHT0-83211	FATMAX L Trigger clamp - 450mm	-	4	3 253560 832117	
FMHT0-83236	FATMAX L Trigger clamp - 600mm	-	4	3 253560 832360	
FMHT0-83237	FATMAX L Trigger clamp - 900mm	-	2	3 253560 832377	
FMHT0-83238	FATMAX XL Trigger clamp - 150mm	-	4	3 253560 832384	
FMHT0-83239	FATMAX XL Trigger clamp - 300mm	-	4	3 253560 832391	
FMHT0-83213	FATMAX XL Trigger clamp - 450mm	-	4	3 253560 832131	
FMHT0-83240	FATMAX XL Trigger clamp - 600mm	-	4	3 253560 832407	
FMHT0-83241	FATMAX XL Trigger clamp - 900mm	-	2	3 253560 832414	
FMHT0-83242	FATMAX XL Trigger clamp - 1250mm	-	2	3 253560 832421	
FMHT0-83243	FATMAX Trigger Clamp 4-pack			3253560832438	

FATMAX® CLUTCH LOCK F CLAMP

STANLEY
FATMAX



- Cast iron housing for strength and durability
- Strong locking to prevent sudden movement
- Cold-rolled steel limits bending under tension
- Soft handle for comfort at high force
- Soft protective caps prevent damage to the work material

CODE	DESCRIPTION				PRICE
FMHT0-83244	FATMAX Clutch Lock F Clamp 200 mm	-	4		
FMHT0-83245	FATMAX Clutch Lock F Clamp 400 mm	-	2		
FMHT0-83246	FATMAX Clutch Lock F Clamp 600 mm	-	2		
FMHT0-83247	FATMAX Clutch Lock F Clamp 800 mm	-	2		

MAXSTEEL® "C" CLAMP

- Striking anti-rust finish
- Rigid design
- Iron and steel construction for heavy duty applications
- Threaded for smooth use and durability
- Extra large T-shaped handle for extra turning power
- Clamping force:
- 0-83-033/034/035: 680kg



CODE	DESCRIPTION				PRICE
0-83-033	75mm/3" C-Clamp	X	12		
0-83-034	100mm/4" C-Clamp*	X	12		
0-83-035	150mm/6" C-Clamp*	X	8		

*Not in the Nordic assortment - special order required

SPRING CLIP

- Large & deep jaws for maximum clamping capacity
- Smooth unlocking
- Pivoting guards hold both straight and rounded objects
- Precise clamping without ratchet teeth
- Clamp springs open automatically when unlocked
- Soft handle for comfort at high force



CODE	DESCRIPTION				PRICE
STHT0-83199	Spring clamp - 50 mm	-	6		
STHT0-83200	Spring clamp - 100 mm	-	6		

METAL SPRING CLIPS



- Protective caps formed by injection
- Stamped metal construction for added strength
- Ergonomically designed handles for safety and stability
- Cold formed springs for durability

CODE	DESCRIPTION				PRICE
9-83-079	25mm/1" Metal Spring Clip	X	50		
9-83-080	50mm/2" Metal Spring Clip	X	30		

SPRING CLAMP SET - 16 PCS



- Bag of 16 spring clamps, ideal for light holding and clamping
- Cold rolled steel springs for durability
- Reinforced nylon construction
- Various sizes for common holding tasks
- Rotating clamping jaws, toothed jaw pads

CODE	DESCRIPTION				PRICE
STHT0-83094	Spring clamp set - 16 pcs	X	6		

BAILEY® BAND CLAMP



- 4.5m belt length for large and irregular objects
- Bi-material, trilobular handle for increased comfort and turning power
- Metal and reinforced nylon construction for strength and durability

CODE	DESCRIPTION				PRICE
0-83-100	4.5/15" Band clamp	X	4		

BAILEY® CORNER CLAMP FOR LIGHT DUTY APPLICATIONS



- Individually adjustable clamping arms to clamp material of the same or different thickness at right angles
- Mounting holes to secure the clamp to the work surface
- Durable cast aluminum construction

CODE	DESCRIPTION				PRICE
0-83-121	Corner clamp	X	4		

BAILEY® CORNER CLAMP FOR HEAVY DUTY APPLICATIONS



- Pronounced design to clamp material of the same or different thickness at right angles
- Patented rotatable head for use as a parallel screw clamp
- Comfort and maximum turning power thanks to bi-material trilobular handle
- Mounting holes to secure the clamp to the work surface
- Die-cast zinc construction for durability during heavy duty applications

CODE	DESCRIPTION				PRICE
0-83-122	Heavy Duty Corner Clamp	X	2		

MULTI-ANGLE VISE 360°



- Lockable knee joint: rotates 360°
- Convenient thanks to multiple positions
- Cast aluminum construction - light but strong
- Clamp capacity: 80mm
- Removable protective covers
- Base can be fixed on workbench for extra stability

CODE	DESCRIPTION				PRICE
1-83-069	Multi Angle Vise 360	-	2		

QUICK-RELEASE VICE



- Vice with quick-release system
- One-hand lever to easily open and close jaws for quick repositioning
- Steel construction for greater durability and long life
- Rubber guards can be removed to use steel jaws if required
- Secure the thread to a workbench for a firm grip and easy repositioning
- Clamping capacity: 160 kg

CODE	DESCRIPTION				PRICE
0-83-179	Quick-release screw	X	2		

MAXSTEEL® VISE



- Durable cast iron construction for strength
- Threaded for smooth use and durability
- Base can be fixed on a workbench for stability
- Base pivots for versatile use
- Chrome handles and screw against corrosion
- Clamping force: 1100 kg

CODE	DESCRIPTION				PRICE
1-83-065	100mm/4" Vise	-	1		

MAXSTEEL® HEAVY DUTY VISE



- Durable cast iron construction for strength
- Threaded for smooth use and durability
- Base can be fixed on a workbench for stability
- Base pivots for versatile use
- Chrome handles and screw against corrosion
- Clamping force:
 - 1-83-066: 1400 kg
 - 1-83-067: 1800 kg
 - 1-83-068: 2200 kg

CODE	DESCRIPTION				PRICE
1-83-066	100mm/4" Heavy Duty Vise	-	1		
1-83-067	125mm/5" Heavy Duty Vise	-	1		
1-83-068	150mm/6" Heavy Duty Vise*	-	1		

*Not in the Nordic assortment - special order required

SUCCION PADS



- Adherence against selected surface and tightening of the handles
- Carrying power : 60kg (30kg per head)
- diameter each rubber : 120mm
- Double headed suction cup for transport
- Double rubber suction pad
- Locking by 2 swinging levers
- Single suction pad has a maximum load of 20kg, safe working load of 10kg
- Double suction pad has a maximum load of 40kg, safe working load of 25kg
- 1 head suction pad (2-14-053) - diameter : 120mm

CODE	DESCRIPTION				PRICE
2-14-053	Suction pad - single	-	1		3253562140531
2-14-054	Suction pads - 2 heads	-	1		3253562140548

THE MEASURE OF A PRO™



SAWS

STANLEY saws are designed for manual precision, accuracy, and sharpness, our handsaws can cut through endless tasks. Whether you're working with molding, trim, or cutting with or across the woodgrain, we have the tool for you.

PRACTICAL INFO

THE BEST SAWS TO MEET YOUR NEEDS

Choosing a hand saw is about selecting the right size and type of saw teeth for a specific job. Tooth size is measured in the number of full teeth per inch (tpi). Fewer and larger teeth give a fast cut, while more and smaller teeth ensure a finer finish.

The table below is a quick guide to which sawtooth size is best suited for different requirements. The number of teeth and the suggested applications can be found in the properties for all saws on the following pages.

FATMAX® BLADEARMOR® ☆☆☆☆☆

STANLEY
FATMAX

BLADE THICKNESS:
1 mm

BLADEARMOR - APPLIFLON INDUCTION
HARDENED PROTECTIVE COATING
For less resistance during sawing and against
rust formation

TRI-MATERIAL HANDLE
WITH FINGER REST
for extra comfort

INDUCTION HARDENED TEETH
for extra long life



TRIPLE GROUND TOOTH TECHNOLOGY
for faster and smoother sawing:
cutting in both push and pull motion

BLADE MARKINGS
for quickly marking of different angles

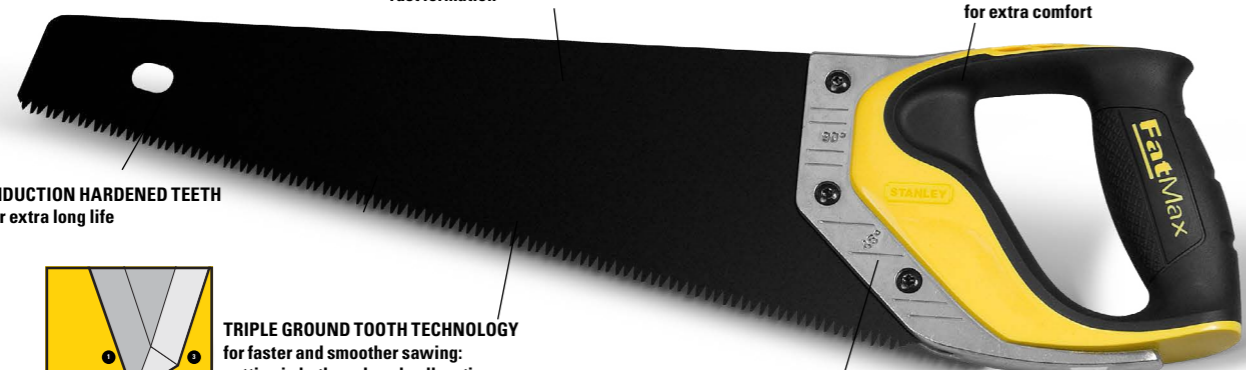

SHARPCUT ☆☆☆

STANLEY

Blade thickness: 0,85 mm



JET-CUT BLADEARMOR® ☆☆☆☆☆

STANLEY

Blade thickness: 0,85 mm*
Deeper teeth



*ook beschikbaar zonder BladeArmor®



TRADECUT ☆☆☆

STANLEY

Blade thickness: 0,85 mm



SPECIALITY HAND SAWS

For specific applications and materials
such as jab saws, drywall saws,
aerated concrete saws, hacksaws, etc.



	SAW APPLICATION	SAW TEETH REQUIRED
CONSTRUCTION WORK	Construction carpentry, joists, stud framing, chipboard	LARGE TEETH 7 teeth per inch
FINISH WORK	Architraves and mouldings panelling, flooring, PVC	SMALL TEETH 11 teeth per inch
SPECIALIST WORK	Flooring, PVC pipes and mouldings, plasterboard and drywall panels, cellular concrete	SPECIALLY DESIGNED SAWS With different numbers and types of teeth to suit specific tasks

SAWS FOR WOOD

FATMAX® JETCUT HAND SAW

STANLEY
FATMAX

AVAILABLE IN 7 TEETH PER INCH - for rough cuts
AVAILABLE IN 11 TEETH PER INCH - for fine cutting

HANDLE MADE OF ANTICHOOC
PLASTIC AND SOFT
ELASTOMER
for a better and more
comfortable grip

WITH APPLIFLON COATING
for lower resistance during
cutting and against rust formation

BLADE THICKNESS: 1 MM
less wobble,
better control

DEEPER INSERTED TEETH
for faster cutting
INDUCTION HARDENED TEETH
the blade stays sharp longer



TOOTH WITH 3 CUTTERS
for faster and smoother cuts

HANDLE WITH MARKED ANGLES
FOR 45° AND 90°

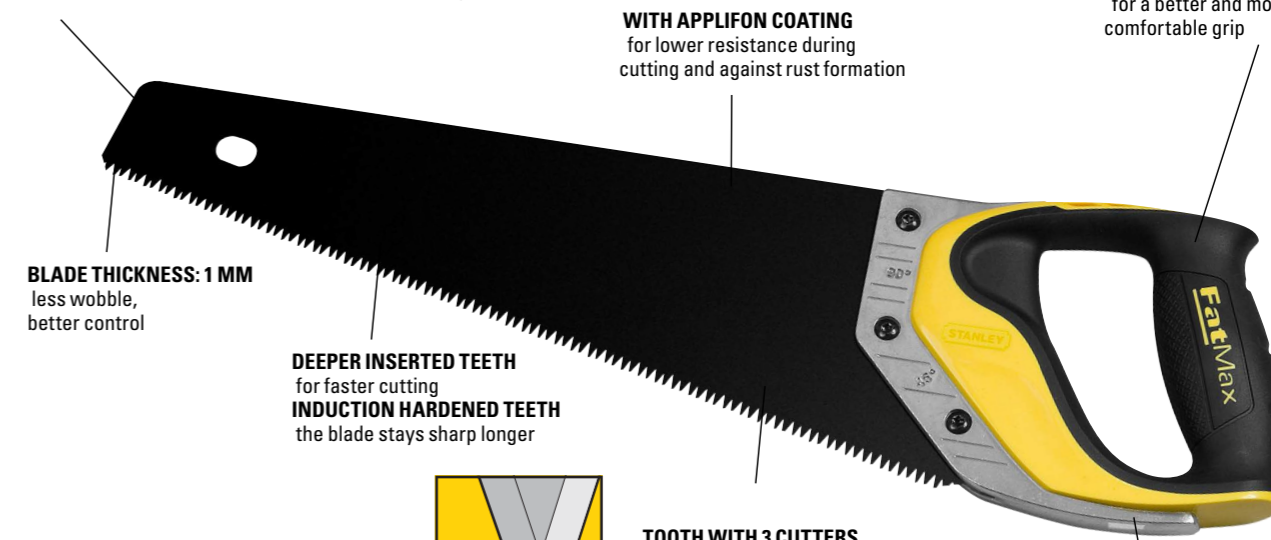

CODE	DESCRIPTION				PRICE
2-20-528	FATMAX JetCut Hand saw 380 mm - 7T/inch	-	6	3 2 5 3 5 6 2 1 2 0 5 2 8 5	
2-20-529*	FATMAX JetCut Hand saw 500 mm - 7T/inch	-	6	3 2 5 3 5 6 2 1 2 0 5 2 9 2	
2-20-530	FATMAX JetCut Hand saw 550 mm - 7T/inch	-	6	3 2 5 3 5 6 2 1 2 0 5 3 0 8	
2-20-533*	FATMAX JetCut Hand Saw 450mm - 11T/inch	-	6	3 2 5 3 5 6 2 1 2 0 5 3 3 9	

*Not in the Nordic assortment - special order required. Minimum order quantity applied.

JETCUT HAND SAW SP



- Bi-Material handle for reduces vibrations and increased comfort - improved comfort and control
- With APPLIFLON coating for lower resistance during cutting and against corrosion
- Tothing with 3 cutting edges - for faster and smoother cuts
- Blade thickness: 0.85mm - less wobbling, better control
- Deeper cut teeth for faster cutting
- Special teeth for 20-50% faster and smoother cutting
- Induction hardened teeth - the blade stays sharp longer
- Handle with marking angles for 45° and 90°
- Available in 7 teeth per inch for coarse cuts

CODE	DESCRIPTION				PRICE
2-20-151*	JetCut Hand Saw SP 500mm - 7T/inch	-	6	3 2 5 3 5 6 2 1 2 0 1 5 1 5	

*Not in the Nordic assortment - special order required. Minimum order quantity applied.

JETCUT HAND SAW LAMINATOR

- Universal "Hardpoint" teeth and handle with marking angles for 45° and 90°
- Suitable for laminate



CODE	DESCRIPTION	☐	☒	☐	PRICE
2-20-180	JetCut Laminator 450mm - 11T/inch	-	6	3 253562 201805	

JETCUT HAND SAW

- Bi-Material handle for reduces vibrations and increased comfort - improved comfort and control
- Tothing with 3 cutting edges - for faster and smoother cuts
- Blade thickness: 0.85mm - less wobbling, better control
- Deeper cut teeth for faster cutting
- Induction hardened teeth - the blade stays sharp longer
- Handle with marking angles for 45° and 90°
- Available in 7 teeth per inch for coarse cuts - for soft wood, plastic coated chipboard and PVC
- Available in 11 teeth per inch for fine cuts - for both hard and soft wood, as well as a wide selection of plastic coated chipboard



CODE	DESCRIPTION	☐	☒	☐	PRICE
2-15-281*	JetCut Hand saw SP 380 mm - 7T/inch*	-	6	3 253562 152817	
2-15-283*	JetCut Hand Saw SP 450mm - 7T/inch*	-	6	3 253562 152831	
2-15-288*	JetCut Hand Saw SP 500mm - 7T/inch*	-	6	3 253562 152886	
2-15-289	JetCut Hand saw SP 550 mm - 7T/inch	-	6	3 253562 152893	
2-15-594	JetCut Hand saw HP Fine 380 mm - 11T/inch	-	6	3 253562 155948	
2-15-595*	JetCut Hand saw HP Fine 450 mm - 11T/inch*	-	6	3 253562 155955	
2-15-599	JetCut Hand saw HP Fine 500 mm - 11T/inch	-	6	3 253562 155993	
2-15-244	JetCut Hand saw HP Fine 550 mm - 11T/inch	-	6	3 253562 152442	

*Not in the Nordic assortment - special order required. Minimum order quantity applied.

TRADECUT HAND SAW

- Bi-Material handle for reduces vibrations and increased comfort - improved comfort and control
- Ergonomic design, optimal position of the fingers for extra control and comfort
- Tothing with 3 cutting edges - for faster and smoother cuts
- Blade thickness: 0.85mm - less wobbling, better control
- Induction hardened teeth - the blade stays sharp longer
- Ultrasonically welded saw blade and handle for extra durability
- Handle with marking angles for 45° and 90°
- Available in 8 teeth per inch for coarse cuts
- Available in 11 teeth per inch for fine cutting



CODE	DESCRIPTION	☐	☒	☐	PRICE
STHT20348-1	Tradecut Hand saw Universal 380 mm - 8T/inch	-	10	3 253561 203480	
STHT20354-1	Tradecut Hand saw Universal 450 mm - 8T/inch*	-	10	3 253561 203541	
STHT20350-1	Tradecut Hand saw Universal 500 mm - 8T/inch*	-	10	3 253561 203503	
STHT1-20352	Tradecut Hand saw Universal 550 mm - 8T/inch	-	10	3 253561 203527	
STHT20349-1	Tradecut Hand saw Fine 380 mm - 11T/inch	-	10	3 253561 203497	
STHT20355-1	Tradecut Hand saw Fine 450 mm - 11T/inch*	-	10	3 253561 203558	
STHT20351-1	Tradecut Hand saw Fine 500 mm - 11T/inch*	-	10	3 253561 203510	
STHT1-20353	Tradecut Hand saw Fine 550 mm - 11T/inch	-	10	3 253561 203534	

*Not in the Nordic assortment - special order required. Minimum order quantity applied.

SHARPCUT HAND SAW

- Ergonomic bi-material handle - improved comfort and control
- Ergonomic design, optimal position of the fingers for extra control and comfort
- Tothing with 2 cutting surfaces
- Blade thickness: 0.85mm - less wobbling, better control
- Induction hardened teeth - the blade stays sharp longer
- Ultrasonically welded saw blade and handle for extra durability
- Handle with marking angles for 45° and 90°
- Available in 7 teeth per inch for coarse cuts
- Available in 11 teeth per inch for fine cutting



CODE	DESCRIPTION	☐	☒	☐	PRICE
STHT20366-1	SharpCut Hand saw 380 mm - 7T/inch	-	10	3 253561 203664	
STHT20369-1	SharpCut Hand saw 380 mm - 11T/inch	-	10	3253561203695	
STHT20367-1*	SharpCut Hand Saw 500mm - 7T/inch*	-	10	3 253561 203671	
STHT20368-1	SharpCut Hand saw 550 mm - 7T/inch	-	10	3 253561 203688	
STHT20371-1*	SharpCut Hand Saw 500mm - 11T/inch*	-	10	3 253561 203718	
STHT20372-1	SharpCut Hand Saw 550mm - 11T/inch	-	10	3 253561 203725	
STHT20368-9	SharpCut Hand Saw 550mm - 7T/inch - Display x24	-	24	3253569203680	
STHT20372-9	SharpCut Hand Saw 550mm - 11T/inch - Display x24	-	24	3253569203727	

*Not in the Nordic assortment - special order required. Minimum order quantity applied.

FATMAX® TENON SAW

STANLEY
FATMAX



- Bi-Material handle for reduces vibrations and increased comfort bolted to the blade
- Reinforced back for better control when cutting
- Tothing with 3 cutting edges - for faster and smoother cuts
- Handle with marking angles for 45° and 90°
- Available in 11 teeth per inch
- Available in 13 teeth per inch

CODE	DESCRIPTION				PRICE
2-17-199	FATMAX Tenon Saw 300mm - 11T/inch	X	4		
2-17-201	FATMAX Tenon Saw 350mm - 11T/inch	X	4		
2-17-202	FATMAX Tenon Saw 350mm - 13T/inch	X	4		

FATMAX® FLOORBOARD SAW

STANLEY
FATMAX



- Bi-Material handle for reduces vibrations and increased comfort bolted to the blade
- Extra teeth on the round nose for cutting blind slots and holes
- Handles with marking angles 45° and 90°

CODE	DESCRIPTION				PRICE
2-17-204	FATMAX Floorboard Saw 350 mm - 14T/inch	X	4		

STANLEY® FATMAX® REVERSIBLE FLUSH CUT SAW

STANLEY
FATMAX



- Quick reversible towel saw
- Ergonomic handle
- Reinforced back
- Extra wide saw blade for fine wood cutting

CODE	DESCRIPTION				PRICE
0-15-252	FATMAX Reversible Flush Cut Saw	-	8		

MITER BOXES

MITER BOX METAL ADJUSTABLE



- Precision miter box
- Specially hardened and tempered replacement blade with extra fine teeth
- Tightening screw on blade facilitates blade changes and ensures a clean and precise cut
- Miter box and saw guides
- Miter adjustable at 30, 45, 60, and 90°
- Adjustable length gauge for repeated cuts
- Handle with comfortable elastomer strip
- Workpiece can be fastened quickly by adjustable clamp nails
- Including saw blade (1-20-809) 560 mm

CODE	DESCRIPTION				PRICE
1-20-800	Miter Box Metal Adjustable L560 mm/W143 mm/H95 mm	-	1		
1-20-809	Spare Blade Miter Saw 1-20-800	-	1		

PLASTIC MITER BOX WITH MITER SAW

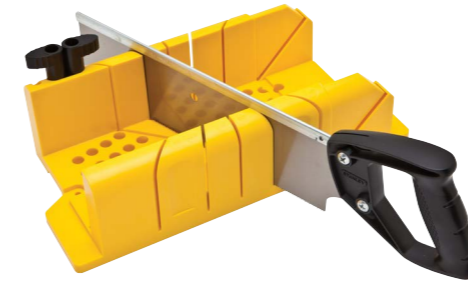

- Plastic miter box - miter saw with fine teeth included
- Built-in saw stop to prevent damage to the miter box
- Adjustable to angles of 90°, 45° and 22.5°
- Object can be fixed thanks to 2 supplied pins

CODE	DESCRIPTION				PRICE
1-20-600	Plastic Miter Box with Miter Saw L300 mm/W130 mm/H80 mm	X	6		

PLASTIC MITER BOX WITHOUT MITER SAW

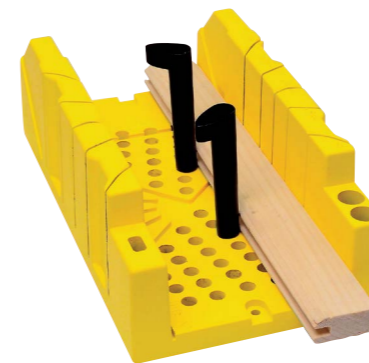

- Plastic miter box
- Built-in saw stop to prevent damage to the miter box
- Adjustable to angles of 90°, 45° and 22.5°
- Object can be fixed thanks to 2 supplied pins

CODE	DESCRIPTION				PRICE
1-20-112	Miter box Plastic L300 mm/W130 mm/H80 mm	-	6		

MITER BOX PLASTIC ABS WITH MITER SAW

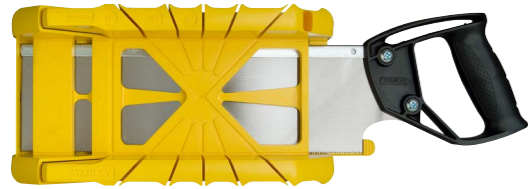

- Light anti-choc ABS miter box with miter saw
- Holes in the bottom to attach miter box to workbench
- Adjustable to angles of 90°, 45° and 22.5°
- Object can be fixed thanks to 2 supplied pins

CODE	DESCRIPTION				PRICE
1-19-800	Plastic Miter Box with Miter Saw L350 mm/W143 mm/H95 mm	-	8	3 2535611198007	

MITER BOX PLASTIC ABS WITHOUT MITER SAW



- Light anti-shock ABS miter box
- Holes in the bottom to attach miter box to workbench
- Adjustable to angles of 90°, 45° and 22.5°
- Object can be fixed thanks to 2 supplied pins

CODE	DESCRIPTION				PRICE
1-19-212	Miter box Plastic L300 mm/W143 mm/H95 mm	-	8	3 2535611192128	

MITER BOX WOOD



- Traditional miter box made of dried beech wood, capacity: 120 mm
- Glued and screwed for strength
- Adjustable to angles of 45° and 90°
- Equipped with suspension eye to fix the miter box to the work table

CODE	DESCRIPTION				PRICE
1-19-194*	Miter Box Wood L350 mm/W122 mm/H60 mm	-	2	3 2535611191947	

*Not in the Nordic assortment - special order required. Minimum order quantity applied.

MITER BOX WOOD STANDARD



- Traditional miter box made of dried beech wood
- Glued and screwed for strength
- Adjustable to angles of 45° and 90°
- Equipped with suspension eye to fix the miter box to the work table

CODE	DESCRIPTION				PRICE
1-19-190*	Miter Box Wood L250 mm/W65 mm/H40 mm	-	2	3 2535611191909	
1-19-191	Miter Box Wood L300 mm/W65 mm/H48 mm	-	2	3 2535611191916	
1-19-192*	Miter Box Wood L350 mm/W82 mm/H48 mm	-	2	3 2535611191923	

*Not in the Nordic assortment - special order required. Minimum order quantity applied.

SPECIFIC SAWS

FATMAX® HAND SAW FOR PVC

STANLEY
FATMAX



- Bi-Material handle for reduces vibrations and increased comfort bolted to the blade
- Tothing with 3 cutting edges - for faster and smoother cuts

CODE	DESCRIPTION				PRICE
2-17-206	FATMAX PVC Hand saw 300 mm - 11T/inch	X	4	3 2535621172068	

FATMAX® COMPASS SAW

STANLEY
FATMAX

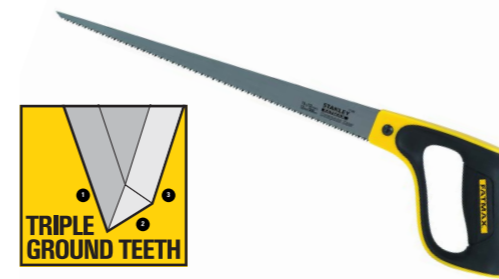

- Bi-Material handle for reduces vibrations and increased comfort bolted to the blade
- Fine-toothed - 9 teeth per inch
- Tothing with 3 cutting edges - for faster and smoother cuts

CODE	DESCRIPTION				PRICE
2-17-205	FATMAX Compass saw 300 mm	X	4	3 2535621172051	

STANLEY® FATMAX® MULTI-SAW WITH RECIPROCAL AND HACK BLADES

STANLEY
FATMAX



- Saw with a hacksaw blade and hacksaw blade
- Ergonomic handle
- Handy for working in limited space

CODE	DESCRIPTION				PRICE
0-20-220	FATMAX Multi saw	X	6	3 253560202200	

FATMAX® JAB SAW

STANLEY
FATMAX



- Sharpened point and thicker blade for easier cutting through drywall
- Tothing with 3 cutting edges - for faster and smoother cuts
- Hardened and tempered blade - ergonomic handle
- Handle made of anti-shock plastic and soft elastomer for a better, comfortable grip and control
- Long, smooth pad, facilitates blade pushing and turning through drywall
- 2-20-556: Supplied with pouch

CODE	DESCRIPTION				PRICE
0-20-556	Jab saw FATMAX 355 mm - 7T/ inch	X	6	3 253560205560	
2-20-556	Jab saw FATMAX 355 mm - 7T/ inch + Holder	X	6	3 2535621205568	
7-20-556	Jab saw FATMAX 355 mm - 7T/ inch + Holder - Display x10	X	10	3253567205563	

FATMAX® FOLDABLE JAB SAW

STANLEY
FATMAX

- 8T/inch - suitable for drywall
- Tothing with 3 cutting edges - for faster and smoother cuts
- Locking mechanism in 3 positions (90°, 135° and 180°) for maximum flexibility - suitable for work in corners and against ceilings
- Ergonomic handle
- Folds compactly for safety
- Sharp point for piercing drywall



CODE	DESCRIPTION				PRICE
FMHT0-20559	FATMAX Foldable Saber Saw	X	6	3 2 5 3 5 6 0 1 2 0 5 5 6 0	

JAB SAW

- Suitable for cut-outs for sockets in drywall
- Sharpened point and thicker blade for easier cutting through drywall
- Long, smooth pad, facilitates blade pushing and turning through drywall



CODE	DESCRIPTION				PRICE
0-15-206*	Jab Saw 150mm - 6T/inch*	X	6	3 2 5 3 5 6 0 1 1 5 2 0 6 2	

*Not in the Nordic assortment - special order required. Minimum order quantity applied.

FATMAX® JAPANESE SAW

STANLEY
FATMAX

- Tothing with 3 cutting edges - for faster and smoother cuts
- Bi-Material handle for reduces vibrations and increased comfort
- Flexible saw blade for difficult work : resharpenable



CODE	DESCRIPTION				PRICE
0-20-331	FATMAX Japanese Saw	X	6	3 2 5 3 5 6 0 1 2 0 3 3 1 3	
3-20-331	FATMAX Japanese Saw Blades (1 piece)	X	4	3 2 5 3 5 6 3 1 2 0 3 3 1 0	

FATMAX® JAPANESE SAW FINE

STANLEY
FATMAX

- Saw blade for fine work at the workplace (17 teeth/inch)
- Tothing with 3 cutting edges - for faster and smoother cuts
- Bi-Material handle for reduces vibrations and increased comfort
- Flexible saw blade for difficult work : resharpenable
- Saw blade size: 250 mm



CODE	DESCRIPTION				PRICE
0-20-500*	Japanese Saw Fine 600 mm*	X	4	3 2 5 3 5 6 0 1 2 0 5 0 0 3	

*Not in the Nordic assortment - special order required. Minimum order quantity applied.

FATMAX® JAPANESE SAW FINE AND COARSE

STANLEY
FATMAX

- Saw blade for fine (17 teeth/inch) & coarse (8 teeth/inch) work
- Tothing with 3 cutting edges - for faster and smoother cuts
- Bi-Material handle for reduces vibrations and increased comfort
- Flexible saw blade for difficult work: resharpenable
- Saw blade size: 250 mm



CODE	DESCRIPTION				PRICE
0-20-501	Japanese Saw Fine/Coarse 600 mm	X	4	3 2 5 3 5 6 0 1 2 0 5 0 1 0	

CELLULAR CONCRETE SAW

- Hand saw with coarse teeth (1.2 teeth per 25 mm), ideal for building blocks and soft stone
- Anti-choc ABS handle attached to saw with 2 screws
- Handle with marking angles for 45° and 90°
- Induction hardened teeth - the blade stays sharp longer



CODE	DESCRIPTION				PRICE
1-15-441	Cellular Concrete Saw 650mm - 1.2T/inch	-	4	3 2 5 3 5 6 1 1 1 5 4 4 1 6	

FATMAX® HAND SAW PLASTERBOARD 550 MM

STANLEY
FATMAX

- Redesigned handle, combination of 3 materials for maximum ease of use, ergonomics and durability
- With APPLIFON coating for lower resistance during cutting and against rust formation
- Induction hardened teeth - the blade stays sharp longer
- Tothing with 3 cutting edges - for faster and smoother cuts
- 7 teeth per inch
- Handle with marking angles for 45° and 90°



CODE	DESCRIPTION				PRICE
2-20-534	FATMAX Hand saw Plasterboard 550 mm - 7T/inch	-	6	3 2 5 3 5 6 2 1 2 0 5 3 4 6	

JETCUT PLASTERBOARD SAW APPLIFLON

- Handle made of anti-shock plastic and soft elastomer for a better, comfortable grip and control
- Induction hardened teeth - the blade stays sharp longer
- Tothing with 3 cutting edges - for faster and smoother cuts
- Combination saw with conventional teeth at the front for ease of starting cuts and long flexible teeth at the back for a quick and clean finish
- Handle with marking angles for 45° and 90°
- With APPLIFON coating for lower resistance during cutting and against rust formation
- Ideal for cutting plasterboard



CODE	DESCRIPTION				PRICE
2-20-149	JetCut Plasterboard Saw APPLIFLON 550 mm - 7T/inch	-	6		

JETCUT DRYWALL SAW

- Handle made of anti-shock plastic and soft elastomer for a better, comfortable grip and control
- "HardPoint" teeth, does not need to be sharpened
- JetCut teeth with three cutting edges for faster and smoother cuts
- Combination saw with conventional teeth at the front for ease of starting cuts and long flexible teeth at the back for a quick and clean finish
- Handle with marking angles for 45° and 90°
- Ideal for cutting plasterboard



CODE	DESCRIPTION				PRICE
2-20-037	JetCut Drywall Saw 550mm - 7T/inch	-	6		

JIGSAW

- Round, chrome-plated steel frame stretched
- Hardened and tempered High carbon steel for sharpness retention saw blade
- Blade is tightened by turning the handle
- Supplied with 3 spare blades



CODE	DESCRIPTION				PRICE
0-15-106	FATMAX Jigsaw 6 3/4"	X	6		
0-15-061	Jigsaw blade	X	10		



PRACTICAL INFO

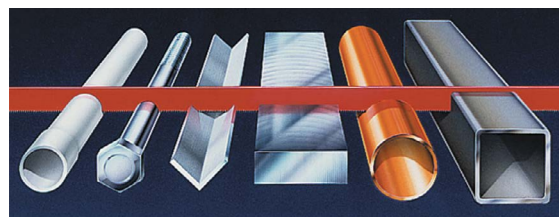

SLOPED NOSE PROFILE
Allows cutting in places that are difficult to reach and has a capacity of 100 mm

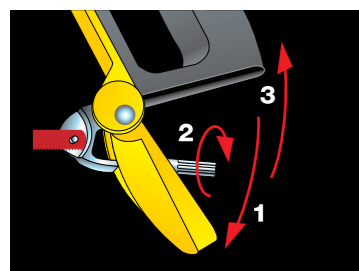
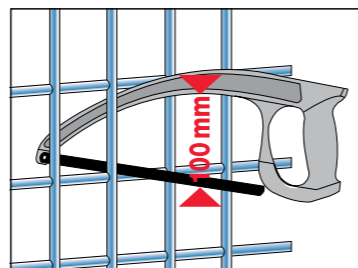

PATENTED QUICK BLADE CHANGE AND PATENTED BLADE TENSION
Easy tension memorisation and adjustment using a tightening wheel

HACK SAW FRAME

TURBO CUT™

1. H.L.E.-steel blade
2. Bi-material handle for intensive use. Groove support for precise guidance

SAW APPLICATION	REQUIRED SAW TEETH
For cutting soft or hard materials: semi-soft steel, cast iron, bronze.	8 TEETH PER CM
For cutting hard metals, steel and obtuse angles. Best suited for all uses.	10 TEETH PER CM
For cutting material with a thickness of less than 3 mm, fine tubes/pipes, profiles and sharp corners.	12 TEETH PER CM

SAWING METAL

HACKSAW FATMAX®

STANLEY
FATMAX



- Front handle with thumb rest
- Sturdy injection molded steel frame
- Tensioning mechanism protects the regulating wheel
- Spring-operated tension system
- Non-slip handle with magazine for spare blades
- Tension up to 150 kg
- Maximum cutting capacity 127 mm

CODE	DESCRIPTION				PRICE
1-20-531	FATMAX Hacksaw 300mm - 24T/inch	-	2		

FATMAX® 5 IN 1 HACKSAW

STANLEY
FATMAX



- Unique saw with 5 different saw blade settings
- Standard position of the hacksaw blade 90° with large cutting depth (120 mm) - can also be placed at an angle of 45°
- Hacksaw blade can be placed on the yellow handle as a compact hacksaw
- Saw blade can be mounted on the front of the yellow or black handle as a scrub saw
- Load up to 100kg
- Magazine for spare blades in the handle: Supplied with hacksaw blade and wood saw blade

CODE	DESCRIPTION				PRICE
0-20-108	FATMAX 5in1 Hacksaw	-	4		

HACKSAW TURBOCUT



- Fiberglass clad steel frame for maximum strength, rigidity and shock absorption
- Ergonomically designed bi-material frame and comfortable handle
- Patented quick tension and release system to replace and tighten the blade
- Maximum cutting capacity 110 mm
- Tension up to 80kg

CODE	DESCRIPTION				PRICE
1-20-110	Hacksaw frame Bi-Material TurboCut 300 mm - 24T/inch	-	4		

HACKSAW



- Sturdy steel frame
- Ribbed plastic handle for better grip
- Four blade positions for vertical and horizontal cutting
- Traditional wing nut for clamping the saw blade
- Maximum cutting capacity 95 mm
- Tension up to 100kg

CODE	DESCRIPTION				PRICE
1-15-122	Hacksaw frame 300 mm - 24T/inch	-	6		

HACKSAW - WOODEN HANDLE

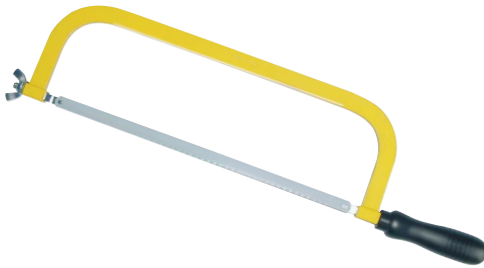

- Saw blade adjustable in 4 positions
- Supplied with flexible LION saw blade
- Maximum cutting capacity 95 mm
- Total length 510 mm

CODE	DESCRIPTION				PRICE
1-15-123	Hacksaw - wooden handle*	-	5		

*Not in the Nordic assortment - special order required. Minimum order quantity applied.

FATMAX® MINI HACKSAW 300

STANLEY
FATMAX



- Rigid steel frame with knurled blade mounting screw
- Straight injection molded handle
- Blade length adjustable
- Flexible blade can be used for recessed cuts
- Suitable for all blade lengths and broken blades

CODE	DESCRIPTION				PRICE
0-15-211	FATMAX Mini Hacksaw Frame 300 mm	X	10		

MINI HACKSAW 250



- One piece injection molded frame with blade fixing screw
- Blade length adjustable
- Flexible blade can be used for recessed cuts
- Suitable for all blade lengths and broken blades

CODE	DESCRIPTION				PRICE
0-20-807	Hacksaw frame Mini 300 mm	X	6		

HACKSAW JUNIOR



- Comfortable molded handle
- Nickel plated square section frame for high strength and impact resistance
- Quick release lever to clamp and replace the blade

CODE	DESCRIPTION				PRICE
0-15-218	Hacksaw frame Junior 150 mm	X	10		
3-15-905	Hacksaw blade 150 mm - 5 pcs/card	X	10		

MINI HACKSAW WITH PLASTIC PISTOL GRIP



- Easy tensioning of the saw blade with the tensioning screw
- Supplied with 150mm saw blade

CODE	DESCRIPTION				PRICE
1-15-317	Hacksaw frame Mini 150 mm	-	12		
3-15-905	Hacksaw blade 150 mm - 5 pcs/card	X	10		

SPARE BLADES HACKSAWS

FATMAX® HACKSAW BLADES

STANLEY
FATMAX



- Bimaterial, flexible saw blade
- 3x sharper and 15x longer life than standard carbon steel saw blades
- Available in 300mm (18, 24 and 32 TPI)

CODE	DESCRIPTION				PRICE
FMHT0-20194	FATMAX Hacksaw Blades 300 mm 18TPI - 2 pcs	X	10	3	2 5 3 5 6 0 1 2 0 1 9 4 4
FMHT0-20195	FATMAX Hacksaw Blades 300 mm 24TPI - 2 pcs	X	10	3	2 5 3 5 6 0 1 2 0 1 9 5 1
FMHT0-20196	FATMAX Hacksaw Blades 300 mm 32TPI - 2 pcs	X	10	3	2 5 3 5 6 0 1 2 0 1 9 6 8
FMHT0-20232	FATMAX Hacksaw blades 300 mm mix - 5 pieces*	X	5	3	2 5 3 5 6 0 2 0 2 3 2 3
FMHT2-20209	FATMAX Hacksaw Blades 300 mm 24TPI - 10 pcs	X	5	3	2 5 3 5 6 2 2 0 2 0 9 3

*Not in the Nordic assortment - special order required. Minimum order quantity applied.

HACKSAW BLADE LASER CUT



- Fully heat treated high speed steel (HSS)
- Sturdy and strong performing blade

CODE	DESCRIPTION				PRICE
1-15-558	Hacksaw blade 300 mm - 24T/ inch (box 100)*	-	1	3	2 5 3 5 6 1 1 5 5 5 8 1
1-15-559	Hacksaw blade 300 mm - 32T/ inch (box 100)*	-	1	3	2 5 3 5 6 1 1 5 5 5 9 8
2-15-558	Hacksaw blade 300mm - 24T/ inch (5pcs/card)*	X	5	3	2 5 3 5 6 2 1 5 5 5 8 0

*Not in the Nordic assortment - special order required. Minimum order quantity applied.

HACKSAW BLADE RUBIS



- Fully heat treated molybdenum steel (HSS)
- Rigid, extra durable blade - designed to cut all types of metal

CODE	DESCRIPTION				PRICE
0-15-900*	Hacksaw blade 300 mm - Mix (5 pieces/card)	X	5	3	2 5 3 5 6 0 1 5 9 0 0 9
0-15-906	Hacksaw blade 300mm - 24T/ inch (2pcs/card)	X	5	3	2 5 3 5 6 0 1 5 9 0 6 1
1-15-906	Hacksaw blade 300 mm - 24T/ inch (box 100)	-	1	3	2 5 3 5 6 1 1 5 9 0 6 0
2-15-906*	Hacksaw blade 300mm - 24T/ inch (5pcs/card)	X	5	3	2 5 3 5 6 2 1 5 9 0 6 9
1-15-907*	Hacksaw blade 300 mm - 32T/ inch (box 100)	-	1	3	2 5 3 5 6 1 1 5 9 0 7 7

*Not in the Nordic assortment - special order required. Minimum order quantity applied.

HACKSAW BLADE LION



- Flexible general purpose tool steel hacksaw blade

CODE	DESCRIPTION				PRICE
0-15-801*	Hacksaw blade 300 mm - Mix (5 pcs/card)*	X	5	3	2 5 3 5 6 0 1 5 8 0 1 9
0-15-842	Hacksaw Blade 300mm - 24T/inch (2pcs/card)	X	10	3	2 5 3 5 6 0 1 5 8 4 2 2
1-15-842*	Hacksaw blade 300mm - 24T/inch (box 100)*	-	1	3	2 5 3 5 6 1 1 5 8 4 2 1
2-15-842	Hacksaw Blade 300mm - 24T/inch (5pcs/card)	X	5	3	2 5 3 5 6 2 1 5 8 4 2 0

*Not in the Nordic assortment - special order required. Minimum order quantity applied.

SAW SETS

3 IN 1 SAW



- 3 saws in 1: a universal pull saw blade, a hacksaw blade and a scrub saw
- Soft grip handle for enhanced control and comfort

CODE	DESCRIPTION				PRICE
0-20-092	3in1 Saw	X	2	3	2 5 3 5 6 0 2 0 0 9 2 3

TREE/PRUNING SAWS

RAKER TOOTH BOW SAW HP



- Oval tubular steel frame, for strength
- Simple system for changing and tensioning saw blades
- American teeth induction hardened - the blade stays sharp longer
- Handle with anti-shock hand protection
- Blade with straight teeth, suitable for green and wet wood

CODE	DESCRIPTION				PRICE
1-15-379	Raker Tooth Bow Saw HP 530 mm	-	6	3 253561 153792	
1-15-368	Raker Tooth Bow Saw HP 610 mm	-	6	3 253561 153686	
1-15-403	Raker Tooth Bow Saw HP 760 mm	-	6	3 253561 154034	

SPARE BLADES TREE/PRUNING SAWS

RAKER SAW BLADE



- Straight teeth for dried wood
- Made of high quality Swedish steel
- Induction hardened teeth - the blade stays sharp longer

CODE	DESCRIPTION				PRICE
1-15-382	Raker saw blade 530 mm	-	10	3 253561 153822	
1-15-385	Raker saw blade 610 mm	-	10	3 253561 153853	
1-15-388	Raker saw blade 750 mm	-	10	3 253561 153884	

RAKER/HACKSAW



- Medium duty, tubular steel frame with oval section for strength
- Steel hand protection
- Simple system to replace and tighten the blade
- Supplied with a raker blade for green wood and one hacksaw blade for hacksaws

CODE	DESCRIPTION				PRICE
1-20-447	Tree/Hacksaw 300 mm	-	6	3 253561 204470	
1-20-437	Raker saw blade 300 mm	-	10	3 253561 204371	

RAKER TOOTH BOW SAW BLADE



- Blade with American teeth, suitable for green and wet wood
- Made of high quality Swedish steel
- Induction hardened teeth - the blade stays sharp longer

CODE	DESCRIPTION				PRICE
1-15-439	Raker Tooth Bow Saw blade 530 mm	-	10	3 253561 154393	
1-15-446	Raker Tooth Bow Saw blade 610 mm	-	10	3 253561 154461	
1-15-448	Raker Tooth Bow Saw blade 750 mm	-	10	3 253561 154485	



THE MEASURE OF A PRO™



CHISELS AND PUNCHES

Dress, shape, drive and refine hard materials from masonry to metal with professional-grade STANLEY® cold chisels, punches, and files.



FATMAX® CHISELS

**STANLEY
FATMAX**

These FATMAX® chisels are made with hardened, tempered high-chrome carbon alloy steel blades for edge retention. They are 50% stronger than Stanley wood chisels. They are constructed with a steel thru-tang shaft and a steel striking cap for use with steel-headed hammers.

STANLEY chisels are sharpened to an exact 25° angle and can be used for all types of applications. For even sharper cutting, they can also be sharpened at an angle of 30°.

Standard angle (25°)



Sharpening angle (30°)

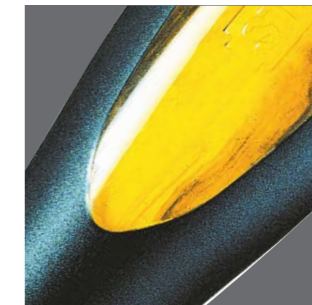

BIMATERIAL HANDLE

A flexible urethane coating ensures optimum ease of use. The FATMAX® handle is longer and provides greater precision when handling the chisel.

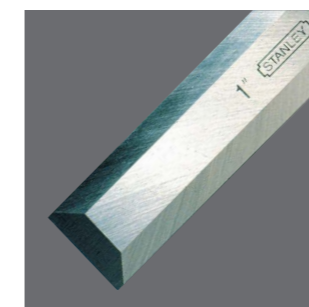

BLADE OF HIGH QUALITY

Blade of professional quality EN31 for exceptional cutting performance

METAL END CAP

Protects the chisel during intensive use and against the impact of hammer strikes. Ideal for striking & for durability and long life.



THRU TANG DESIGN

Superior Thru Tang design – 50% stronger* handle for extra reassurance and durability.

CHISELS SWEETHEART AND BAILEY

CHISEL SET SWEETHEART 8-PIECE

· 3, 6, 10, 12, 16, 18, 25, 32mm



CODE	DESCRIPTION				PRICE
1-16-793	Sweetheart Chisel set 8-piece*	-	3		

*Not in the Nordic assortment - special order required. Minimum order quantity applied.

CHISELS BAILEY

CHISEL BAILEY®



· Beech wood handle
· Copper finish
· Hardened and tempered blade with protective cap

CODE	DESCRIPTION				PRICE
2-16-382*	Wood chisel 6 mm*	X	5		
2-16-383*	Wood chisel 8 mm*	X	5		
2-16-384*	Wood chisel 10 mm*	X	5		
2-16-385*	Wood chisel 12 mm*	X	5		
2-16-386*	Wood chisel 14 mm*	X	5		
2-16-387*	Wood chisel 15 mm*	X	5		
2-16-388*	Wood chisel 16 mm*	X	5		
2-16-389*	Wood chisel 18 mm*	X	5		
2-16-390*	Wood chisel 20 mm*	X	5		
2-16-391*	Wood chisel 22 mm*	X	5		
2-16-392*	Wood chisel 25 mm*	X	5		
2-16-393*	Wood chisel 28 mm*	X	5		
2-16-394*	Wood chisel 30 mm*	X	5		
2-16-395*	Wood chisel 35 mm*	X	5		
2-16-396*	Wood chisel 40 mm*	X	5		

*Not in the Nordic assortment - special order required. Minimum order quantity applied.

WOOD CHISEL SET BAILEY® 5-PIECE WOODEN BOX

· Beech wood handle
· Copper finish
· Supplied in a wooden box
· 6, 10, 15, 20, 25mm



CODE	DESCRIPTION				PRICE
2-16-217	Wood chisel set Bailey 5-piece Wooden Box	X	2		

CHISEL SET BAILEY® 6-PIECE PLASTIC BOX

· Beech wood handle
· Copper finish
· Hardened and tempered blade with protective cap
· 6, 10, 12, 16, 20, 25mm
· Contents: 16-382, 16-384, 16-385, 16-388, 16-392, 16-390
· Also available separately



CODE	DESCRIPTION				PRICE
1-16-416*	Wood chisel set 6-piece (6, 10, 12, 16, 20, 25 mm)	-	1		

*Not in the Nordic assortment - special order required. Minimum order quantity applied.

CHISELS FATMAX®

FATMAX® CHISELS

STANLEY
FATMAX



- Blade extends into impact head, making the handle up to 50% stronger and less likely to break
- Steel striking head - can be used with a hammer
- High quality steel blade - maintains sharpness and quality of cutting surface and edges
- Ergonomic handle - for improved grip and maximum control
- Full-length blade protection - for extra safety

CODE	DESCRIPTION				PRICE
0-16-251	FATMAX Chisel 6 mm	X	1		
0-16-252	FATMAX Chisel 8 mm	X	1		
0-16-253	FATMAX Chisel 10 mm	X	1		
0-16-254	FATMAX Chisel 12 mm	X	1		
0-16-255	FATMAX Chisel 14 mm	X	1		
0-16-256	FATMAX Chisel 15 mm	X	1		
0-16-257	FATMAX Chisel 16 mm	X	1		
0-16-258	FATMAX Chisel 18 mm	X	1		
0-16-259	FATMAX Chisel 20 mm	X	1		
0-16-260	FATMAX Chisel 22 mm	X	1		
0-16-261	FATMAX Chisel 25 mm	X	1		
0-16-262	FATMAX Chisel 30 mm	X	1		
0-16-263	FATMAX Chisel 32 mm	X	1		
0-16-264	FATMAX Chisel 35 mm	X	1		
0-16-265	FATMAX Chisel 38 mm*	X	1		
0-16-266	FATMAX Chisel 40 mm	X	1		
0-16-267	FATMAX Chisel 50 mm	X	1		

*Not in the Nordic assortment - special order required. Minimum order quantity applied.

FATMAX® MORTISE CHISEL SET

STANLEY
FATMAX



- 2-16-268: 12, 18, 25mm
- 2-16-270: 10, 15, 20mm
- 2-16-271: 6, 10, 15, 20, 25mm

CODE	DESCRIPTION				PRICE
2-16-270	FATMAX chisel set 3-piece (10, 15, 20 mm)	X	1		
2-16-268	FATMAX Mortise Chisel Set 3 Pieces (12, 18, 25 mm)*	X	1		
2-16-271	FATMAX Mortise Chisel Set 5 Pieces (6, 10, 15, 20, 25 mm)	X	1		

*Not in the Nordic assortment - special order required. Minimum order quantity applied.

FATMAX® CHISEL WITH DOUBLE CUTTING EDGE

STANLEY
FATMAX



- With cutting surface on the side of the chisel for additional applications
- Steel core for more durability
- Hardened and tempered carbon steel blade
- Bi-material handle for extra comfort
- Impact cap
- Long blade for more control during work
- Blade width 25 mm

CODE	DESCRIPTION				PRICE
FMHT0-16067	FATMAX Chisel with Double Cutting Edge	X	16		

STANLEY® FATMAX® UTILITY WRECKING CHISEL

STANLEY
FATMAX



- Demolition chisel with double cutting edge
- Suitable for multiple applications: demolishing, prying, splitting
- Impact cap
- Bi-material handle for extra comfort
- Curved handle with extra finger protection
- Supplied with bag

CODE	DESCRIPTION				PRICE
FMHT16693-0	STANLEY® FATMAX® Utility Wrecking Chisel	X	8		

STANLEY® FATMAX® 25 MM POCKET CHISEL

STANLEY
FATMAX



- Each side of the handle folds around the blade thanks to an innovative mechanism
- The blade can be safely stored in the handle
- Tempered carbon steel with sharp edge
- Impact cap for added durability
- Short blade for extra power and control

CODE	DESCRIPTION				PRICE
FMHT0-16145	STANLEY® FATMAX® 25 mm Pocket Chisel	X	16		

CHISELS DYNAGRIP™

CHISEL DYNAGRIP™



- Steel striking head - can be used with a hammer
- Longer ergonomic handle - for an improved grip and maximum control
- Steel blade - for strength and durability
- Pre-sharpened blade - ready to use
- Full-length blade protection - for extra safety

CODE	DESCRIPTION				PRICE
0-16-870	Chisel Dynagrip 6 mm	X	1		
0-16-871	Chisel Dynagrip 8 mm	X	1		
0-16-872	Chisel Dynagrip 10 mm	X	6		
0-16-873	Chisel Dynagrip 12 mm	X	1		
0-16-874	Chisel Dynagrip 14 mm	X	1		
0-16-875	Chisel Dynagrip 15 mm*	X	1		
0-16-876	Chisel Dynagrip 16 mm	X	1		
0-16-877	Chisel Dynagrip 18 mm	X	1		
0-16-878	Chisel Dynagrip 20 mm	X	1		
0-16-879	Chisel Dynagrip 22 mm	X	1		
0-16-880	Chisel Dynagrip 25 mm	X	1		
0-16-881	Chisel Dynagrip 32 mm	X	1		
0-16-882	Chisel Dynagrip 38 mm	X	1		
0-16-889	Chisel Dynagrip 28 mm*	X	6		
0-16-890	Chisel Dynagrip 30 mm*	X	1		
0-16-891	Chisel Dynagrip 35 mm	X	1		
0-16-892	Chisel Dynagrip 40 mm*	X	6		

*Not in the Nordic assortment - special order required. Minimum order quantity applied.

CHISEL SET DYNAGRIP™ 5-PIECE



- 2-16-885: 6, 12, 18, 25, 32mm
- 2-16-888: 6, 10, 15, 20, 25mm

CODE	DESCRIPTION				PRICE
2-16-885	Chisel set Dynagrip 5-piece (6, 12, 18, 25, 32 mm)	X	6		
2-16-888	Chisel set Dynagrip 5-piece (6, 10, 15, 20, 25 mm)*	-	1		

CHISEL SET DYNAGRIP™ 3-PIECE

- 2-16-883: 12, 18, 25mm
- 2-16-887: 10, 15, 20mm



CODE	DESCRIPTION				PRICE
2-16-883	Chisel set Dynagrip 3-piece (12, 18, 25 mm)	X	6		
2-16-887	Chisel set Dynagrip 3-piece (10, 15, 20 mm)*	-	1		

CHISELS BASIC

WOOD CHISELS 5002



- Blade with anti-corrosion coating
- Polypropylene handle, virtually unbreakable

CODE	DESCRIPTION				PRICE
0-16-535	Wood chisel 6 mm*	X	6		
0-16-537	Wood chisel 8 mm*	X	6		
0-16-539	Wood chisel 10 mm*	X	6		
0-16-540	Wood chisel 12 mm	X	6		
0-16-542	Wood chisel 14 mm*	X	6		
0-16-547	Wood chisel 16 mm*	X	6		
0-16-545	Wood chisel 18 mm	X	6		
0-16-548	Wood chisel 20 mm*	X	6		
0-16-549	Wood chisel 22 mm*	X	6		
0-16-551	Wood chisel 25 mm	X	6		
0-16-554	Wood chisel 32 mm*	X	6		
0-16-558	Wood chisel 38 mm*	X	6		

*Not in the Nordic assortment - special order required. Minimum order quantity applied.

MORTISE CHISEL SET BASIC 3-PIECE



- Blade with anti-corrosion coating
- Polypropylene handle, virtually unbreakable
- 12, 18, 25mm

CODE	DESCRIPTION				PRICE
0-16-128	Mortise chisel set Basic 3-piece	X	12		

MORTISE CHISEL SET BASIC 4-PIECE



- Blade with anti-corrosion coating
- Polypropylene handle, virtually unbreakable
- 6, 12, 18, 25mm

CODE	DESCRIPTION				PRICE
0-16-129	Mortise chisel set Basic 4-piece	X	12		

MORTISE CHISEL SET BASIC 6-PIECE



- Blade with anti-corrosion coating
- Polypropylene handle, virtually unbreakable
- With oil and sharpening stone
- 6, 12, 18, 25mm

CODE	DESCRIPTION				PRICE
0-16-130	Mortise chisel set Basic 6-piece	-	6		

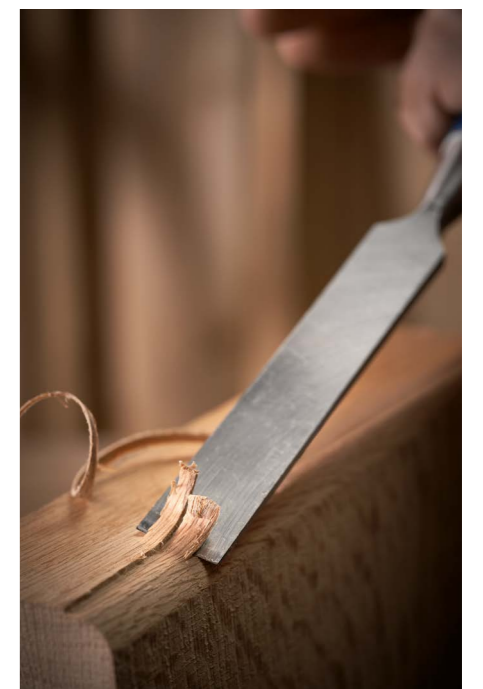

COLD CHISELS FATMAX®

FATMAX® POINTING CHISEL

STANLEY
FATMAX



- With rubber handle
- With hand protection

CODE	DESCRIPTION				PRICE
4-18-327	FATMAX joint chisel 75 mm	-	3		
4-18-328	FATMAX joint chisel 100 mm	-	3		

FATMAX® CONCRETE POINT CHISEL

STANLEY
FATMAX



- With rubber handle
- With hand protection

CODE	DESCRIPTION				PRICE
4-18-329	FATMAX Concrete point chisel 19 mm	-	3		

FATMAX® TRENCH CHISEL

STANLEY
FATMAX



- With rubber handle
- With hand protection

CODE	DESCRIPTION				PRICE
4-18-330	FATMAX Trench chisel 56 mm	-	3		

FATMAX® FLOOR CHISEL

STANLEY
FATMAX



- With rubber handle
- With hand protection

CODE	DESCRIPTION				PRICE
4-18-331	FATMAX Floor chisel 75 mm	-	3		

FATMAX® MASON'S CHISEL

STANLEY
FATMAX



- With rubber handle
- With hand protection

CODE	DESCRIPTION				PRICE
4-18-333	FATMAX mason's chisel 45 mm	-	3		

FATMAX® COLD CHISEL

STANLEY
FATMAX



- With rubber handle
- With hand protection
- Suitable for steel

CODE	DESCRIPTION				PRICE
4-18-332	FATMAX Cold Chisel 25 mm (Long)	-	3		

MASON'S CHISEL

- Chrome vanadium steel - formed in one piece for strength and durability
- Hardened and tempered for extended life and safety
- Powder coated finish for increased visibility



CODE	DESCRIPTION				PRICE
4-18-294	Mason's chisel 45 mm*	-	3		

*Not in the Nordic assortment - special order required. Minimum order quantity applied.

JOINT CHISEL

- Chrome vanadium steel - formed in one piece for strength and durability
- Hardened and tempered for extended life and safety
- Powder coated finish for increased visibility



CODE	DESCRIPTION				PRICE
4-18-297	Joint chisel 100 mm*	-	3		

*Not in the Nordic assortment - special order required. Minimum order quantity applied.

COLD CHISEL

- Chrome vanadium steel - formed in one piece for strength and durability
- Hardened and tempered for extended life and safety
- Powder coated finish for increased visibility
- Suitable for steel



CODE	DESCRIPTION				PRICE
4-18-286	Cold chisel 10 mm	-	3		
4-18-287	Cold chisel 12 mm*	-	3		
4-18-288	Cold chisel 16 mm	-	3		
4-18-289	Cold chisel 19 mm	-	3		
4-18-290	Cold chisel 22 mm	-	3		
4-18-291	Cold chisel 25 mm (Long)	-	3		

*Not in the Nordic assortment - special order required. Minimum order quantity applied.

COLD CHISEL FLAT

- Chrome vanadium steel - formed in one piece for strength and durability
- Hardened and tempered for extended life and safety
- Powder coated finish for increased visibility
- Suitable for steel

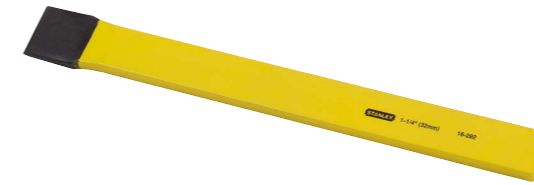

CODE	DESCRIPTION				PRICE
4-18-292	Cold chisel 32 mm (Flat)	-	3		

COLD CHISEL SET 3 PCS

- Chrome vanadium steel - formed in one piece for strength and durability
- Hardened and tempered for extended life and safety
- Powder coated finish for increased visibility
- Suitable for steel



CODE	DESCRIPTION				PRICE
4-18-298	Cold chisel set 3 pieces	X	3		

COLD CHISEL AND PUNCH SET 12-PIECE

- Chrome vanadium steel - formed in one piece for strength and durability
- Hardened and tempered for extended life and safety
- Powder coated finish for increased visibility
- Suitable for steel



CODE	DESCRIPTION				PRICE
4-18-299	Cold chisel and punch set 12 pieces	X	3		

PUNCHES & CENTER POINTS

FATMAX® 2IN1 PUNCH

STANLEY
FATMAX

- Punch set 2 in 1: 1.6 mm and 0.8 mm
- Bi-material non-slip handle

CODE	DESCRIPTION				PRICE
1-58-501	FATMAX 2in1 Punch	X	4		



DYNAGRIP® PUNCH

- Hardened and tempered steel for durability
- Elastomer cover for a better grip
- The nails are 25% longer to get into difficult places
- Long flattened tip for easier nail alignment
- 3 sizes in different colors to easily identify the punches

CODE	DESCRIPTION				PRICE
0-58-911	Punch Dynagrip 0.8 mm	X	6		
0-58-912	Punch Dynagrip 1.6 mm	X	6		
0-58-913	Punch Dynagrip 2.4 mm	X	6		



DYNAGRIP PUNCH SET 3-PIECE

- Induction hardened steel for safety and improved performance
- Color coded for quick identification
- Rubber cover for a better grip
- Longer design for use in hard to reach places
- Suitable for finishing nails

CODE	DESCRIPTION				PRICE
0-58-930	Dynagrip Punch set 3-piece	X	6		



PUNCH

- Hardened and tempered steel
- Knurled handle for an easy grip
- Square striking head with flattened corners

CODE	DESCRIPTION				PRICE
0-58-111	Punch 0.8 mm	X	6		
0-58-112	Punch 1.6 mm	X	6		
0-58-113	Punch 2.4 mm	X	6		
0-58-114	Punch 3.2 mm	X	6		



CENTER POINT

- Hardened and tempered steel center point
- Knurled handle for an easy grip
- Square striking head with flattened corners

CODE	DESCRIPTION				PRICE
0-58-120	Center point 3.2 mm	X	6		



CENTER POINT 10 MM

- Hardened and tempered for extended service life
- Powder coated finish for increased visibility
- Molded in one piece for strength and durability

CODE	DESCRIPTION				PRICE
4-18-236	Center point 10 mm*	-	3		

*Not in the Nordic assortment - special order required. Minimum order quantity applied.



PUNCH SET 6 PCS

- Chrome vanadium steel - formed in one piece for strength and durability
- Hardened and tempered for extended life and safety
- Powder coated finish for increased visibility

CODE	DESCRIPTION				PRICE
4-18-226	Punch Set 6 pcs	X	3		



THE MEASURE OF A PRO™



PLANES

STANLEY has built a worldwide reputation for exceptional planing quality, which remains the reference of choice among professional users to this day.

BAILEY SMOOTHING BENCH PLANE

CHOOSING A PLANE

The Stanley range of planes covers all your likely needs and they all feature the finest hardened, tempered and precision ground chrome carbon alloy steel cutters. As a general guide the longer and wider the plane the truer the surface along the length of the timber will be.

BAILEY PLANE

General purpose bench plane for workshop, site or fine finishing

REPLACEABLE BLADE PLANE

For stock removal, smoothing and rebating wood

SMALL BENCH PLANES / BLOCK PLANES

For final finishing and for use with one hand.

REPLACEABLE BLADE BLOCK PLANE

Blade can be positioned for standard use or bull nose for working in corners

REBATE PLANES

For grooves and large works.

CABINETMAKER'S PLANES

For delicate joinery.

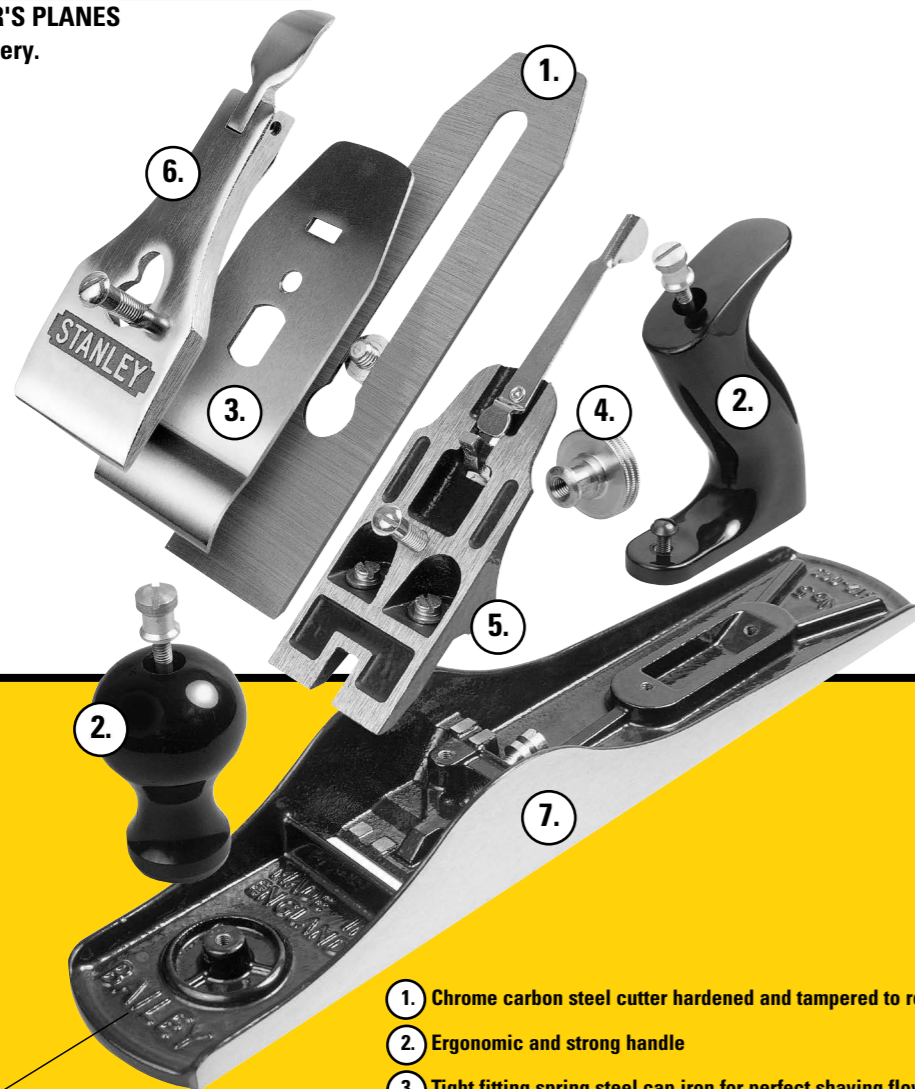

THE BAILEY PLANE
ALL STANLEY KNOW-HOW
IN ONE SINGLE PLANER.

1. Chrome carbon steel cutter hardened and tempered to retain a keen cutting edge
2. Ergonomic and strong handle
3. Tight fitting spring steel cap iron for perfect shaving flow
4. Finger tip adjustment for depth of cut and cutter alignment
5. Fully adjustable frog for all tasks and timber types
6. Kidney shaped lever cap screw hole prevents accidental slippage of cutter
7. Precision cast fine grey iron base for stability and wear resistance. Precision round base and sides ensure performance to the highest tolerances

BAILEY® PLANERS

BENCH PLANE N°4



- Suitable for general use
- Cherry wood handles
- Sturdy brass adjusters
- 1 simple adjustment mechanism for lateral and depth control
- Convenient and quick mechanism to adjust the mouth
- Base and cleat molded in 1 piece to reduce vibration
- Cast iron base
- Smooth ground sole, accurate between .07 and .003 mm
- Cutting angle 45°
- A2 steel chisel - 3 mm

CODE	DESCRIPTION				PRICE
1-12-136	Bench plane n°4 - 245 x 50 mm	-	1	3 2 5 3 5 6 1 1 1 2 1 3 6 4	

STANLEY® "NO. 62" SWEETHEART™ LOW ANGLE JACK PLANE



- Suitable for larger surfaces
- Cherry wood handles
- Sturdy brass adjusters
- 1 simple adjustment mechanism for lateral and depth control
- Convenient and quick mechanism to adjust the mouth
- Base and cleat molded in 1 piece to reduce vibration
- Cast iron base
- Smooth ground sole, accurate to .07-.003 mm
- Cutting angle 12°
- A2 steel chisel - 4.7mm

CODE	DESCRIPTION				PRICE
1-12-137	STANLEY® "No. 62" Sweetheart™ Low Angle Jack Plane*	-	1	3 2 5 3 5 6 1 1 1 2 1 3 7 1	

*Not in the Nordic assortment - special order required. Minimum order quantity applied.. Minimum order quantity applied.

STANLEY® BAILEY® PROFESSIONAL SMOOTHING PLANE



- For general use
- Painted, black steel version with smooth ground sole and sides
- With adjustable frog and fine adjustment

CODE	DESCRIPTION				PRICE
1-12-003	STANLEY® BAILEY® Professional Smoothing Plane n°3 - 240 x 45 mm	X	1	5 0 0 0 3 6 6 1 1 2 0 0 3 4	
1-12-004	STANLEY® BAILEY® Professional Smoothing Plane n°4 - 245 x 50 mm	X	1	5 0 0 0 3 6 6 1 1 2 0 0 4 1	

JACK PLANE BAILEY® N°5



- General usage
- Rapid removal of chips prior to construction work
- Smooth sole

CODE	DESCRIPTION				PRICE
1-12-005	Jack plane Bailey n°5 - 350 x 50 mm	X	6	5 0 0 0 3 6 6 1 1 2 0 0 5 8	

FORE PLANE BAILEY® N°6



- Precise Plane of protruding edges and to plane wide long planks
- Smooth sole

CODE	DESCRIPTION				PRICE
1-12-006	Driving plane Bailey n°6 - 450 x 60 mm*	-	1	3 2 5 3 5 6 1 1 1 2 0 0 6 0	

*Not in the Nordic assortment - special order required. Minimum order quantity applied.

FORE PLANE BAILEY® N°7



- Precise Plane of protruding edges and to plane wide long planks
- Smooth sole

CODE	DESCRIPTION				PRICE
1-12-007	Driving plane Bailey n°7 - 560 x 60 mm	-	1	3 2 5 3 5 6 1 1 1 2 0 0 7 7	

HANDYMAN PLANER

BENCH PLANE HANDYMAN



- For general use
- With smooth ground sole and sides
- With adjustable frog

CODE	DESCRIPTION				PRICE
1-12-203	Bench Plane Handyman (H1203) - 240 x 45 mm	X	1	5 0 0 0 3 6 6 1 1 2 2 0 3 8	
0-12-312	Iron 45MM for 1-12-203 (H1203)				
1-12-204	Bench Plane Handyman (H1204) - 245 x 50 mm	X	1	5 0 0 0 3 6 6 1 1 2 2 0 4 5	
12/1/205	Jack plane Handyman (H1205) - 356x50mm	X	1	5 0 0 0 3 6 6 1 1 2 2 0 5 2	

IRON FOR HANDYMAN AND BAILEY®



- Made of chrome-plated carbon steel for long-lasting sharpness
- For correct adjustment when sharpening (25°)
- Suitable for 1-12-004, 1-12-005, 1-12-204 and 1-12-205

CODE	DESCRIPTION				PRICE
0-12-313	Planer blade Single 50 mm	X	6	3 2 5 3 5 6 0 1 1 2 3 1 3 0	

SB BENCH PLANERS

BENCH PLANE SB3 AND SB4



- For light Plane work
- Simple adjustment of the chisel by means of 2 adjusting screws

CODE	DESCRIPTION	✉	✕	📊	PRICE
1-12-033	Bench plane SB3 210 x 45 mm	X	1	5 000366 120331	
1-12-034	Bench plane SB4 245 x 50 mm	X	1	3 253561 120343	

REPLACEMENT IRONS - OVERVIEW TABLE

Planer	Iron Dimnesions	Replacement iron	Planer	Iron Dimnesions	Replacement iron
0-12-105	8.10 mm x 50.75 mm	0-12-378	1-12-102	33.35 mm x 100 x 25 mm	0-12-202
1-12-003	44.52 mm x 187 mm	0-12-312	1-12-116	41.5 mm x 111 mm	0-12-330
1-12-004	51.1 mm x 190 mm	0-12-313	1-12-136	50.88 mm x 130.3 mm	0-12-141
1-12-005	51.1 mm x 190 mm	0-12-313	1-12-137	49.45 mm x 110.5 mm	12-142-1
1-12-006	60.35 mm x 190 mm	0-12-315	1-12-139	41.32 mm x 107.97 mm	0-12-143
1-12-007	60.35 mm x 190 mm	0-12-315	1-12-151	55mm (W)	0-12-350
1-12-020	41.5 mm x 112.35 mm	0-12-504	1-12-152	55mm (W)	0-12-350
1-12-033	44.8 x 83 x 2mm	0-12-133	1-12-203	44.52 mm x 187 mm	0-12-312
1-12-034	51.18 mm x 94 mm	0-12-134	1-12-204	51.1 mm x 190 mm	0-12-313
1-12-045	60.35 mm x 190 mm	0-12-315	1-12-205	51.1 mm X 190 mm	0-12-313
1-12-060	41.5 mm x 112 x 35 mm	0-12-504	1-12-220	41.5 mm X 112.35 mm	0-12-504
1-12-078	38.9 x 103.8 x 2mm	1-12-333	12-004	51.1 mm X 190 mm	0-12-313
1-12-090		1-12-328	12-005	51.1 mm X 190 mm	0-12-313
1-12-100	50.7 x 8 x 0.76mm	0-12-376 0-12-378 0-12-379	12-060	35 mm X 112 mm	0-12-504
			12-102	33.35 mm X 100 x 25 mm	0-12-202
			12-220	41.52 mm X 112 x 35 mm	0-12-504
			5-12-020	41.52 mm X 112.35 mm	0-12-504
			5-12-060	35 mm X 112 mm	0-12-504
			STHT12164-8	190X51X2 mm	TBC
			STHT12165-8	190X51X2 mm	TBC

REPLACEMENT BLADE PLANERS

REPLACEMENT BLADE PLANE RB10



- Plane with smooth sole and sides
- Can be used as a rabbet plane, Bench plane
- Fully depth adjustable
- Supplied with 6 spare blades, quickly replaceable and safely stored in the handle

CODE	DESCRIPTION	✉	✕	📊	PRICE
1-12-100	Combination slicer RB10 260 x 50 mm	X	6	5 000366 121000	

REPLACEMENT BLADE PLANE RB5



- Light, cast model plane with machined sole
- Can be used as a rabbet plane, Bench plane and nose plane
- Spare blades can be safely stored in the handle
- Supplied with 2 spare blades (0-12-378)

CODE	DESCRIPTION	✉	✕	📊	PRICE
0-12-105	Replacement blade plane RB5 150 x 50 mm	X	2	3 253560 121051	

PLANER CUTTER



- 12-378 : straight for grooving or Plane edges (RB108)
- For use on 1-12-100 (RB10) and 0-12-105 (RB5)

CODE	DESCRIPTION	✉	✕	📊	PRICE
0-12-378	Planer cutter Straight 50 mm - 5 pcs/card	X	10	3 253560 123789	

BLOCK PLANERS

BLOCK PLANE 60 1/2



- Fully adjustable cutting depth, alignment and jaw opening
- Cutting angle : 13.5°
- For end grain and plastic

CODE	DESCRIPTION				PRICE
12-1-060	Block Plane 60 1/2 150 x 35mm	X	1	2 5 3 5 6 1 1 2 0 6 0 2	

PLANER CUTTER FOR 12-060 (NEW MODEL)

- Made of chrome-plated carbon steel for long-lasting sharpness

CODE	DESCRIPTION				PRICE
0-12-504	Plane cutter 1-12-060 New 35 mm	X	6	2 5 3 5 6 0 1 2 5 0 4 2	



BLOCK PLANE 9 1/2



- Fully adjustable cutting depth, alignment and jaw opening
- Cutting angle : 21°
- For fine grain finishing and general Plane

CODE	DESCRIPTION				PRICE
12/1/020	Block plane 9 1/2 160 x 40 mm	X	1	2 5 3 5 6 1 1 2 0 2 0 6	

BLOCK PLANE 220



- Fully adjustable cutting depth and alignment
- General Plane
- Cutting angle: 21°

CODE	DESCRIPTION				PRICE
1-12-220	Block plane 220 180 x 40 mm	X	1	2 5 3 5 6 1 1 2 2 2 0 0	

PLANER CUTTER FOR 12-020 AND 12-220 (NEW MODEL)

- Made of chrome-plated carbon steel for long-lasting sharpness
- For use on:
 - 1-12-020 Bench Plane 9 1/2 160 x 40 mm
 - 1-12-220 Bench Plane 220 180 x 40 mm

CODE	DESCRIPTION				PRICE
0-12-508	Planer tool 1-12-020 / 1-12-220 New 40 mm	X	6	2 5 3 5 6 0 1 2 5 0 8 0	



BLOCK PLANE 110



- Easy to set up
- Bench plane for general Plane work
- Cutting angle: 21°

CODE	DESCRIPTION				PRICE
1-12-116	Block plane 110 180 x 40 mm	X	1	2 5 3 5 6 1 1 2 1 1 6 6	

BLOCK PLANE 102



- Easy to set up
- Bench plane for general Plane work
- Cutting angle: 21°

CODE	DESCRIPTION				PRICE
1-12-102	Block plane 102 140 x 34 mm	-	1	2 5 3 5 6 1 1 2 1 0 2 9	

SPECIFIC PLANERS

REBATE PLANE



- Sharpened sole and sides
- Integrated handle
- Fully adjustable, with pre-cutter, complete with width and depth guide
- Black lacquered version

CODE	DESCRIPTION				PRICE
12/1/078	Rebate plane 255 x 38 mm	-	1	3 253561 120787	

GHOST SHAVE



- Easy to set up
- 12-151: flat sole for flat and convex surfaces
- 12-152: round sole for concave surfaces

CODE	DESCRIPTION				PRICE
1-12-151	Spoke slicer Flat 55 mm	-	1	5 000366 121512	
1-12-152	Spoke slicer Round 55 mm	-	1	5 000366 121529	

PLANER ACCESSORIES

SHARPENING SET 3 PIECES



- Lacquered clamp, for clamping planer blades and plug-in chisels
- Fold-out protractor with precise positions (25°, 30° and 35°)
- For sharpening and greasing all planers and chisels in widths from 3 to 60 mm
- For a precise sharp angle
- With sharpening stone: one side for degreasing and one side for sharpening

CODE	DESCRIPTION				PRICE
0-16-050	Sharpening set 3 pieces	X	4	3 253560 160500	

**Other spare parts are available
through our after-sales service**

2helpU.com

**FOR SERVICE OR
REPAIRS PLEASE CONTACT:**

Nordics: Aftersales.Nordics@SBDinc.com

THE MEASURE OF A PRO™



FILES AND SURFORM®

Owning quality finishing tools says a lot about how serious a woodworker you are. Stanley's line of finishing tools is made with quality materials. The parts are precision ground. And they have features that give woodworkers greater control and accuracy.

STANLEY is the inventor of SURFORM, a must-have hand tool. It is the ideal solution for processing, sanding, rasping, shaping, filing and smoothing all types of materials. In short, SURFORM is always ready for use.

FILES

PROFILE						SLIDE		
						SMOOTH	SEMI-SMOOTH	HYBRID
FLAT	SQUARE	TRIANGLE	Half round	ROUND	CHAINSAW			
General applications	General and angles	sharp angles	Corners and arcs	Holes and arches	Chainsaw	Fine finish	General finish	Fast application

TRIANGULAR FILE



- High carbon steel for sharpness retention
- Bi-Material handle for reduces vibrations and increased comfort

CODE	DESCRIPTION				PRICE
0-22-461	Triangular File Semi-smooth 150 mm	X	3		
0-22-460	Triangular File Bastard 200 mm	X	3		
0-22-462	Triangular File Semi-smooth 200 mm	X	3		

HALF ROUND FILE



- High carbon steel for sharpness retention
- Bi-Material handle for reduces vibrations and increased comfort

CODE	DESCRIPTION				PRICE
0-22-494	Half Round File Bastard 150 mm*	X	3		
0-22-455	Half round File Semi-smooth 150 mm*	X	3		
0-22-501	Half Round File Bastard 200 mm	X	3		
0-22-456	Half round File Semi-smooth 200 mm	X	3		

*Not in the Nordic assortment - special order required. Minimum order quantity applied.

FLAT FILE



- High carbon steel for sharpness retention
- Bi-Material handle for reduces vibrations and increased comfort

CODE	DESCRIPTION				PRICE
0-22-486	Flat File Bastard 150 mm*	X	3		
0-22-450	Flat File Semi-smooth 150 mm	X	3		
0-22-441	Flat File Bastard 200 mm	X	3		
0-22-451	Flat File Semi-smooth 200 mm	X	3		
0-22-499	Flat File Sweet 200 mm	X	3		

*Not in the Nordic assortment - special order required. Minimum order quantity applied.

ROUND FILE



- High carbon steel for sharpness retention
- Bi-Material handle for reduces vibrations and increased comfort

CODE	DESCRIPTION				PRICE
0-22-442	Round File Bastard 150 mm	X	3		
0-22-496	Round File Semi-smooth 150 mm	X	3		
0-22-443	Round File Bastard 200 mm	X	3		
0-22-444	Round File Semi-smooth 200 mm	X	3		

SQUARE FILE



- High carbon steel for sharpness retention
- Bi-Material handle for reduces vibrations and increased comfort

CODE	DESCRIPTION				PRICE
0-22-458	Square File Semi-smooth 150 mm	X	3		

CHAIN SAW FILE



- High carbon steel for sharpness retention
- Bi-Material handle for reduces vibrations and increased comfort

CODE	DESCRIPTION				PRICE
0-22-491	Chainsaw File 200 x 4 mm*	X	3		
0-22-492	Chainsaw File 200 x 4.8 mm*	X	3		

*Not in the Nordic assortment - special order required. Minimum order quantity applied.

TAPER SAW FILE



- High carbon steel for sharpness retention
- Bi-Material handle for reduces vibrations and increased comfort

CODE	DESCRIPTION				PRICE
0-22-487	Taper saw File Semi-smooth 150 mm*	X	3		
0-22-488	Taper saw File Sweet 150 mm*	X	3		

*Not in the Nordic assortment - special order required. Minimum order quantity applied.

SET NEEDLE FILES 6 PCS



- High carbon steel for sharpness retention
- Bi-Material handle for reduces vibrations and increased comfort

CODE	DESCRIPTION				PRICE
0-22-500	Set Needle Files 6 pcs	X	10		

FILES SET 150 MM 3-PIECE



- High carbon steel for sharpness retention
- Bi-Material handle for reduces vibrations and increased comfort
- Contents: triangular, flat and round file

CODE	DESCRIPTION				PRICE
0-22-445	Set Files Bastard 150 mm 3-piece*	X	4		

*Not in the Nordic assortment - special order required. Minimum order quantity applied.

SET FILES SEMI-SMOOTH 200 MM 3-PIECE



- High carbon steel for sharpness retention
- Bi-Material handle for reduces vibrations and increased comfort
- Contents: triangular, flat and Half round file

CODE	DESCRIPTION				PRICE
0-22-464	Set Files Semi-smooth 200 mm 3-piece	X	4		

RASPS

HALF ROUND RASP



- High carbon steel for sharpness retention
- Bi-Material handle for reduces vibrations and increased comfort

CODE	DESCRIPTION				PRICE
0-22-469	Half round Rasp Bastard 200 mm*	X	3		
0-22-471	Half round Grater Semisweet 200 mm	X	3		

*Not in the Nordic assortment - special order required. Minimum order quantity applied.

FLAT RASP



- High carbon steel for sharpness retention
- Bi-Material handle for reduces vibrations and increased comfort

CODE	DESCRIPTION				PRICE
0-22-465	Flat Rasp Bastard 200 mm	X	3		
0-22-467	Flat Grater Semi-sweet 200 mm	X	3		

ROUND RASP



- High carbon steel for sharpness retention
- Bi-Material handle for reduces vibrations and increased comfort

CODE	DESCRIPTION				PRICE
0-22-473	Round Rasp Bastard 200 mm*	X	3		
0-22-475	Round Grater Semi-sweet 200 mm	X	3		

*Not in the Nordic assortment - special order required. Minimum order quantity applied.

RASP SET 200 MM 3-PIECE



- High carbon steel for sharpness retention
- Bi-Material handle for reduces vibrations and increased comfort
- Contents: round, semi-circular and flat rasp

CODE	DESCRIPTION				PRICE
0-22-477	Set Rasp Bastard 200 mm 3-piece	X	4		

WHICH SPARE BLADE FITS IN WHICH SURFORM?

	5-21-293 Standard	5-21-393 Half round	5-21-299 Half round	5-21-508 Metal / PVC	5-21-291 Round	5-21-398 Half round	5-21-515 Half round
Wood	•	•	•		•	•	•
Soft woods	•	•	•		•	•	•
Hard wood	•	•					
Fiberboard	•		•		•		•
Multiplex	•		•		•		•
Chipboard	•		•		•		•
Vinyl	•	•	•		•	•	•
Rubber	•		•		•		•
Plastic	•	•	•		•	•	•
Plaster/Gips	•		•		•		•
Limestone	•		•		•		•
Glasfiber	•		•	•	•		•
Brass		•		•		•	
Lead		•		•		•	•
Aluminium		•		•		•	
Copper		•		•		•	
Soft steel				•			
Synthetic material				•			•
Polyester sheets			•	•		•	•
Nylon	•		•		•		•
Linoleum	•		•		•		•
Ceramics		•			•		
Suitable for	5-21-295	5-21-296	5-21-103	5-21-122	5-21-297	5-21-399 5-21-102 5-21-104	5-21-115

SURFORM® METAL

SURFORM® METAL



- Can be used as a plane or file
- Fitted with standard replaceable cutting blade

CODE	DESCRIPTION				PRICE
5-21-122	Surform Metal Plane 255 mm	X	2	3 2 5 3 5 6 5 2 1 1 2 2 1	

SURFORM® METAL BODY PLANE



- Fitted with standard replaceable cutting blade
- With fixed plastic handle

CODE	DESCRIPTION				PRICE
5-21-296	Surform Metal Plane 255 mm	X	2	3 2 5 3 5 6 5 2 1 2 9 6 9	

SURFORM® METAL BODY FLAT FILE



- For pull and push operations depending on the direction of blade position
- Fitted with standard replaceable cutting blade

CODE	DESCRIPTION				PRICE
5-21-295	Surform Metal Body Flat File 255 mm	X	2	3 2 5 3 5 6 5 2 1 2 9 5 2	

SURFORM® ROUND FILE

· For enlarging holes and shaping tightly curved surfaces



CODE	DESCRIPTION				PRICE
5-21-297	Surform Round File 250 mm	X	2	2 5 3 5 6 5 1 2 1 2 9 7 6	

SURFORM® METAL BODY BLOCK PLANE

· Tool for one-handed use, especially for smoothing sharp edges and narrow surfaces



CODE	DESCRIPTION				PRICE
5-21-399	Surform Metal Body Block Plane 140 mm	X	2	2 5 3 5 6 5 1 2 1 3 9 9 7	

PLANE SURFORM® PLASTIC

SURFORM® PLASTIC MOULDED BODY PLANE

· Lightweight, plastic version
· Thumb screw for quick blade release - no tools required



CODE	DESCRIPTION				PRICE
5-21-103	Surform planer file Hobby 255 mm	X	6	2 5 3 5 6 5 1 2 1 1 0 3 0	

SURFORM® PLASTIC MOULDED BODY FLAT FILE

· Lightweight, plastic version
· Slightly curved blade to remove more material, especially when pulling
· Thumb screw for quick blade release - no tools required



CODE	DESCRIPTION				PRICE
5-21-102	Surform Moulded Body Flat File 140 mm	X	6	2 5 3 5 6 5 1 2 1 1 0 2 3	

SURFORM® PLASTIC MOULDED BODY BLOCK PLANE

· Light plastic version
· Thumb screw for quick blade release - no tools required



CODE	DESCRIPTION				PRICE
5-21-104	Surform Moulded Body Block Plane Hobby 140 mm	X	6	2 5 3 5 6 5 1 2 1 1 0 4 7	

SURFORM® MOULDED BODY SHAVER TOOL

· Light plastic version
· Operates by pulling



CODE	DESCRIPTION				PRICE
5-21-115	Surform Moulded Body Shaver Tool 65mm	X	6	2 5 3 5 6 5 1 2 1 1 1 5 3	

SURFORM®

SURFORM, ALWAYS READY TO USE

The STANLEY® SURFORM® sands, rasps, smoothes, shapes and files all types of materials. The secret of its success lies in the blade: hundreds of teeth, sharpened and preset, work like little scrapers. You do not need to sharpen or adjust the blade.

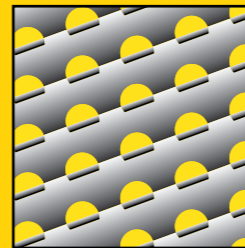

ADJUSTABLE HANDLE
Can be used as a plane
or as a file.



SURFORM® SPARE BLADES

SPARE BLADE STANDARD



- General planing work, also for sharp edges
- For all 250mm frames
- Suitable for types: 5-21-295, 21-296, 5-21-122 and 5-21-103

CODE	DESCRIPTION				PRICE
5-21-293	Surform Spare blade Standard 255 x 42 mm	X	12		

SPARE BLADE FINE CUT



- For fine finishing of hardwood, grain and soft metal
- Suitable for types: 5-21-399, 21-102 and 5-21-104

CODE	DESCRIPTION				PRICE
5-21-398	Surform Spare Blade Fine cut Short 140 x 42 mm	X	12		
5-21-393	Surform Spare blade Fine cut 255 x 42 mm	X	12		

SPARE BLADE HALF ROUND



- For fast chip removal and modeling of curved surfaces
- For all 250mm frames
- Suitable for types: 5-21-295, 5-21-296, 5-21-122 and 5-21-103

CODE	DESCRIPTION				PRICE
5-21-299	Surform Spare Blade Half round 255 x 39 mm	X	12		

SPARE BLADE METAL AND PLASTICS



- Suitable for soft metals and plastics
- For all 250mm frames
- Suitable for types: 5-21-295, 5-21-296, 5-21-122 and 5-21-103

CODE	DESCRIPTION				PRICE
5-21-508	Surform Spare Blade 255 x 42 mm	X	12		

SPARE BLADE ROUND



- Ideal for shaping and smoothing holes and curves
- Suitable for type: 5-21-297

CODE	DESCRIPTION				PRICE
5-21-291	Surform Spare Blade Round 255 x 15 mm	X	6		

SPARE BLADE SHAVER TOOL



- For quick removal of pieces, works by pulling
- Suitable for type: 5-21-115

CODE	DESCRIPTION				PRICE
5-21-515	Surform Spare Blade Scraper 60 x 42 mm	X	12		

THE MEASURE OF A PRO™





SCREWDRIVERS, BITS HEX KEYS

Drive bolts and screws with reliable precision. STANLEY® screwdrivers and hex keys deliver dependable, no-nonsense performance every time. Comfort, quality and versatility are the three attributes we engineer into our screwdriver line. Stanley screwdriver handles are shaped and sized to provide comfort in the hand and torque at the fastener head. The materials and construction are of the highest quality to resist corrosion, chipping and breaking. And with tips ranging from standard to Phillips® to Torx® to flat, STANLEY screwdrivers cover almost every application.





PRACTICAL INFO

OUR ASSORTMENT

Large selection of screwdrivers adapted to each type of screw.

STANLEY ESSENTIAL	STANLEY CUSHION GRIP	STANLEY FATMAX
		
<p>CHROME VANADIUM BLADE Soft handle for comfort Hardened tip</p>	<p>MAGNETIC TIP Steel blade with chrome finish Bi-material handle</p>	<p>STAINLESS STEEL Stainless steel blade Doesn't give rust a chance</p> <p>BOLSTER These screwdrivers incorporate an additional hexagonal bolster for high torque applications, when used with an open end spanner.</p> <p>EXTRA DURABLE TIP 50% longer life*</p>
		<p>Manufactured from heavy-duty carbon silicon steel for outstanding durability and reduced risk of tip breakage.</p>

* Compared to STANLEY Cushion Grip screwdrivers

FLARED	PARALLEL	PHILLIPS	POZI	TORX
				
The collar is flared	The tip has the same width as of the screw			

FATMAX® SCREWDRIVERS

FATMAX® SCREWDRIVER STANDARD FLAT

STANLEY
FATMAX

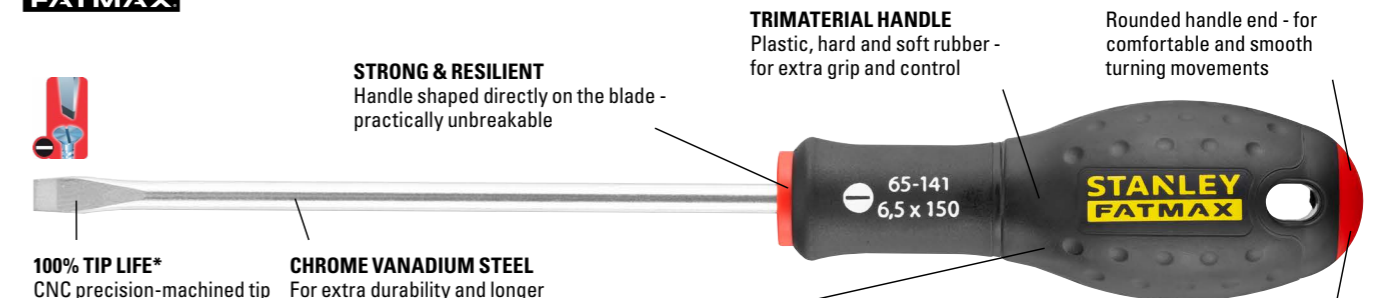

STRONG & RESILIENT
Handle shaped directly on the blade - practically unbreakable

TRIMATERIAL HANDLE
Plastic, hard and soft rubber - for extra grip and control

Rounded handle end - for comfortable and smooth turning movements

100% TIP LIFE*
CNC precision-machined tip for strength, performance and long product life. Ensures optimum dimensional fit, accuracy, control, and reduces cam out. Sand-blasted for protection against corrosion and wear.

CHROME VANADIUM STEEL
For extra durability and longer life

LARGE, COMFORTABLE HANDLE
Large diameter, tri-material soft-grip handle offers excellent torque for driving wood screws. Provides outstanding comfort and grip

COLOR CODING
Clear tip ID on the handle enables easy identification of the right screwdriver for each job

CODE	DESCRIPTION	☐	☒	☒	PRICE	CODE	DESCRIPTION	☐	☒	☒	PRICE
1-65-477*	FATMAX Screwdriver Standard flat 2.5 x 50 mm*	-	6	3	2 5 3 5 6 1 6 5 4 7 7 0	0-65-483*	FATMAX Screwdriver Standard flat 5.5 x 150 mm*	X	6	3	2 5 3 5 6 0 6 5 4 8 3 2
0-65-478*	FATMAX Screwdriver Standard flat 2.5 x 75 mm*	X	6	3	2 5 3 5 6 0 6 5 4 7 8 8	1-65-483*	FATMAX Screwdriver Standard flat 5.5 x 150 mm*	-	6	3	2 5 3 5 6 1 6 5 4 8 3 1
1-65-478*	FATMAX Screwdriver Standard flat 2.5 x 75 mm*	-	6	3	2 5 3 5 6 1 6 5 4 7 8 7	0-65-141	FATMAX Screwdriver Standard flat 6.5 x 150 mm	X	6	3	2 5 3 5 6 0 6 5 1 4 1 1
0-65-479	FATMAX Screwdriver Standard flat 3 x 75 mm	X	6	3	2 5 3 5 6 0 6 5 4 7 9 5	1-65-141*	FATMAX Screwdriver Standard flat 6.5 x 150 mm*	-	6	3	2 5 3 5 6 1 6 5 1 4 1 0
1-65-479*	FATMAX Screwdriver Standard flat 3 x 75 mm*	-	6	3	2 5 3 5 6 1 6 5 4 7 9 4	0-65-137	FATMAX Screwdriver Standard flat 8 x 150 mm	X	6	3	2 5 3 5 6 0 6 5 1 3 7 4
1-65-480*	FATMAX Screwdriver Standard flat 3 x 100 mm*	-	6	3	2 5 3 5 6 1 6 5 4 8 0 0	1-65-137*	FATMAX Screwdriver Standard flat 8 x 150 mm*	-	6	3	2 5 3 5 6 1 6 5 1 3 7 3
0-65-016	FATMAX Screwdriver Standard flat 4 x 100 mm	X	6	3	2 5 3 5 6 0 6 5 0 1 6 2	0-65-138	FATMAX Screwdriver Standard flat 8 x 175 mm	X	6	3	2 5 3 5 6 0 6 5 1 3 8 1
0-65-481	FATMAX Screwdriver Standard flat 4 x 125 mm	X	6	3	2 5 3 5 6 0 6 5 4 8 1 8	1-65-138*	FATMAX Screwdriver Standard flat 8 x 175 mm*	-	6	3	2 5 3 5 6 1 6 5 1 3 8 0
1-65-481*	FATMAX Screwdriver Standard flat 4 x 125 mm*	-	6	3	2 5 3 5 6 1 6 5 4 8 1 7	0-65-139	FATMAX Screwdriver Standard flat 10 x 200 mm	X	6	3	2 5 3 5 6 0 6 5 1 3 9 8
0-65-098	FATMAX Screwdriver Standard flat 5.5 x 100 mm	X	6	3	2 5 3 5 6 0 6 5 0 9 8 8	1-65-139*	FATMAX Screwdriver Standard flat 10 x 200 mm*	-	6	3	2 5 3 5 6 1 6 5 1 3 9 7
1-65-098*	FATMAX Screwdriver Standard flat 5.5 x 100 mm*	-	6	3	2 5 3 5 6 1 6 5 0 9 8 7	0-65-143	FATMAX Screwdriver Standard flat 12 x 250 mm	X	6	3	2 5 3 5 6 0 6 5 1 4 3 5
0-65-482	FATMAX Screwdriver Standard flat 5.5 x 125 mm	X	6	3	2 5 3 5 6 0 6 5 4 8 2 5	1-65-143*	FATMAX Screwdriver Standard flat 12 x 250 mm*	-	6	3	2 5 3 5 6 1 6 5 1 4 3 4
1-65-482*	FATMAX Screwdriver Standard flat 5.5 x 125 mm*	-	6	3	2 5 3 5 6 1 6 5 4 8 2 4						

*Not in the Nordic assortment - special order required. Minimum order quantity applied.

FATMAX® SCREWDRIVERS PARALLEL

STANLEY
FATMAX

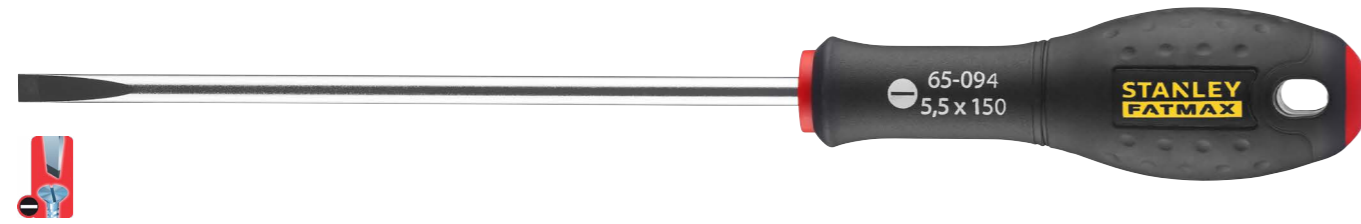

CODE	DESCRIPTION				PRICE
0-65-006	FATMAX Screwdrivers Parallel 2.5 x 50 mm	X	6		
1-65-006*	FATMAX Screwdrivers Parallel 2.5 x 50 mm*	-	6		
0-64-978	FATMAX Screwdrivers Parallel 3 x 50 mm	X	6		
1-64-978*	FATMAX Screwdrivers Parallel 3 x 50 mm*	-	6		
0-65-008*	FATMAX Screwdrivers Parallel 3 x 100 mm*	X	6		
1-65-008*	FATMAX Screwdrivers Parallel 3 x 100 mm*	-	6		
0-64-979*	FATMAX Screwdrivers Parallel 3 x 150 mm*	X	6		
1-64-979	FATMAX Screwdrivers Parallel 3 x 150 mm	-	6		
0-64-983*	FATMAX Screwdrivers Parallel 3.5 x 75 mm*	X	6		
1-64-983*	FATMAX Screwdrivers Parallel 3.5 x 75 mm*	-	6		
0-64-984*	FATMAX Screwdrivers Parallel 3.5 x 100 mm*	X	6		
1-64-984*	FATMAX Screwdrivers Parallel 3.5 x 100 mm*	-	6		
0-65-017	FATMAX Screwdrivers Parallel 4 x 100 mm	X	6		
1-65-017*	FATMAX Screwdrivers Parallel 4 x 100 mm*	-	6		
0-65-093*	FATMAX Screwdrivers Parallel 4 x 150 mm*	X	6		
1-65-093*	FATMAX Screwdrivers Parallel 4 x 150 mm*	-	6		
1-65-476*	FATMAX Screwdrivers Parallel 5.5 x 125 mm*	-	6		
0-65-094	FATMAX Screwdrivers Parallel 5.5 x 150 mm	X	6		
1-65-094*	FATMAX Screwdrivers Parallel 5.5 x 150 mm*	-	6		
0-65-096	FATMAX Screwdrivers Parallel 6.5 x 150 mm	X	6		
1-65-096*	FATMAX Screwdrivers Parallel 6.5 x 150 mm*	-	6		
1-65-097*	FATMAX Screwdrivers Parallel 6.5 x 200 mm*	-	6		

*Not in the Nordic assortment - special order required. Minimum order quantity applied.

FATMAX® SCREWDRIVERS PARALLEL STUBBY

STANLEY
FATMAX



CODE	DESCRIPTION				PRICE
1-65-484	FATMAX Screwdrivers Parallel 4 x 30 mm	-	6		
0-65-400	FATMAX Screwdrivers Parallel 5.5 x 30 mm	X	6		
1-65-400*	FATMAX Screwdrivers Parallel 5.5 x 30 mm*	-	6		
0-65-404*	FATMAX Screwdrivers Parallel 6.5 x 30 mm*	X	6		
1-65-404*	FATMAX Screwdrivers Parallel 6.5 x 30 mm*	-	6		

*Not in the Nordic assortment - special order required. Minimum order quantity applied.

FATMAX® SCREWDRIVER PHILLIPS

STANLEY
FATMAX



CODE	DESCRIPTION				PRICE
0-65-204	FATMAX Screwdriver Phillips PH00 x 50 mm	X	6		
1-65-204*	FATMAX Screwdriver Phillips PH00 x 50 mm*	-	6		
0-65-206	FATMAX Screwdriver Phillips PH0 x 75 mm	X	6		
1-65-206*	FATMAX Screwdriver Phillips PH0 x 75 mm*	-	6		
0-65-207	FATMAX Screwdriver Phillips PH1 x 100 mm	X	6		
1-65-207*	FATMAX Screwdriver Phillips PH1 x 100 mm*	-	6		
1-65-208*	FATMAX Screwdriver Phillips PH1 x 250 mm*	-	6		
0-65-209*	FATMAX Screwdriver Phillips PH2 x 125 mm*	X	6		
1-65-209	FATMAX Screwdriver Phillips PH2 x 125 mm	-	6		
0-65-224*	FATMAX Screwdriver Phillips PH2 x 250 mm*	X	6		
1-65-224*	FATMAX Screwdriver Phillips PH2 x 250 mm*	-	6		
0-65-316*	FATMAX Screwdriver Phillips PH3 x 150 mm*	X	6		
1-65-316	FATMAX Screwdriver Phillips PH3 x 150 mm	-	6		
0-65-317*	FATMAX Screwdriver Phillips PH4 x 200 mm*	X	6		
1-65-317*	FATMAX Screwdriver Phillips PH4 x 200 mm*	-	6		

*Not in the Nordic assortment - special order required. Minimum order quantity applied.

FATMAX® SCREWDRIVER PHILLIPS STUBBY

STANLEY
FATMAX



CODE	DESCRIPTION				PRICE
0-65-406	FATMAX Screwdriver Phillips PH1 x 30 mm	X	6		
1-65-406*	FATMAX Screwdriver Phillips PH1 x 30 mm*	-	6		
0-65-407	FATMAX Screwdriver Phillips PH2 x 30 mm	X	6		
1-65-407*	FATMAX Screwdriver Phillips PH2 x 30 mm*	-	6		

*Not in the Nordic assortment - special order required. Minimum order quantity applied.

FATMAX® SCREWDRIVER POZIDRIV STUBBY

STANLEY
FATMAX



CODE	DESCRIPTION				PRICE
0-65-408*	FATMAX Screwdriver Pozidriv PZ1 x 30 mm*	X	6		
1-65-408*	FATMAX Screwdriver Pozidriv PZ1 x 30 mm*	-	6		
0-65-409*	FATMAX Screwdriver Pozidriv PZ2 x 30 mm	X	6		
1-65-409*	FATMAX Screwdriver Pozidriv PZ2 x 30 mm*	-	6		

*Not in the Nordic assortment - special order required. Minimum order quantity applied.

FATMAX® SCREWDRIVER POZIDRIV

STANLEY
FATMAX

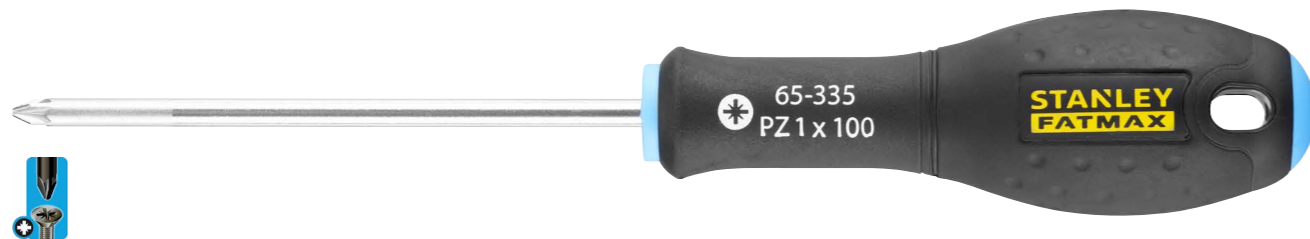

CODE	DESCRIPTION				PRICE
0-65-319	FATMAX Screwdriver Pozidriv PZ0 x 75 mm	X	6		
1-65-319*	FATMAX Screwdriver Pozidriv PZ0 x 75 mm*	-	6		
0-65-335	FATMAX Screwdriver Pozidriv PZ1 x 100 mm	X	6		
1-65-335*	FATMAX Screwdriver Pozidriv PZ1 x 100 mm*	-	6		
0-65-336*	FATMAX Screwdriver Pozidriv PZ1 x 250 mm*	X	6		
1-65-336*	FATMAX Screwdriver Pozidriv PZ1 x 250 mm*	-	6		
0-65-337	FATMAX Screwdriver Pozidriv PZ2 x 125 mm	X	6		
1-65-337*	FATMAX Screwdriver Pozidriv PZ2 x 125 mm*	-	6		
0-62-571*	FATMAX Screwdriver Pozidriv PZ2 x 250 mm*	X	6		
1-62-571*	FATMAX Screwdriver Pozidriv PZ2 x 250 mm*	-	6		
0-65-338	FATMAX Screwdriver Pozidriv PZ3 x 150 mm	X	6		
1-65-338*	FATMAX Screwdriver Pozidriv PZ3 x 150 mm*	-	6		
0-65-339*	FATMAX Screwdriver Pozidriv PZ4 x 200 mm*	X	6		
1-65-339*	FATMAX Screwdriver Pozidriv PZ4 x 200 mm*	-	6		

*Not in the Nordic assortment - special order required. Minimum order quantity applied.

FATMAX® SCREWDRIVERS TORX

STANLEY
FATMAX



CODE	DESCRIPTION				PRICE
0-65-340	FATMAX Screwdriver Torx T10 x 75 mm	X	6		
1-65-340*	FATMAX Screwdriver Torx T10 x 75 mm*	-	6		
0-65-395	FATMAX Screwdriver Torx T15 x 75 mm	X	6		
1-65-395*	FATMAX Screwdriver Torx T15 x 75 mm*	-	6		
0-65-396	FATMAX Screwdriver Torx T20 x 100 mm	X	6		
1-65-396*	FATMAX Screwdriver Torx T20 x 100 mm*	-	6		
0-65-397	FATMAX Screwdriver Torx T25 x 100 mm	X	6		
1-65-397*	FATMAX Screwdriver Torx T25 x 100 mm*	-	6		
0-65-398	FATMAX Screwdriver Torx T30 x 125 mm	X	6		
1-65-398*	FATMAX Screwdriver Torx T30 x 125 mm*	-	6		
0-65-399	FATMAX Screwdriver Torx T40 x 125 mm	X	6		
1-65-399*	FATMAX Screwdriver Torx T40 x 125 mm*	-	6		
FMHT65387-0	FATMAX Screwdriver Torx set - T10 - T15 - T25 - T27 - T30 - T40	-	6		3253560653873

*Not in the Nordic assortment - special order required. Minimum order quantity applied.

FMHT65387-0



FATMAX® SCREWDRIVERWRENCH TORX TAMPERPROOF/RESITORX

STANLEY
FATMAX



CODE	DESCRIPTION				PRICE
FMHT65380-0	FATMAX Screwdriver Torx T10 × 75 mm tamperproof	X	6	3 2 5 3 5 6 0 1 6 5 3 8 0 4	
FMHT65381-0	FATMAX Screwdriver Torx T15 × 75 mm tamperproof	X	6	3 2 5 3 5 6 0 1 6 5 3 8 1 1	
FMHT65382-0	FATMAX Screwdriver Torx T20 × 100 mm tamperproof	X	6	3 2 5 3 5 6 0 1 6 5 3 8 2 8	
FMHT65383-0	FATMAX Screwdriver Torx T25 × 100 mm tamperproof	X	6	3 2 5 3 5 6 0 1 6 5 3 8 3 5	
FMHT65384-0	FATMAX Screwdriver Torx TT27 × 125 mm tamperproof	X	6	3 2 5 3 5 6 0 1 6 5 3 8 4 2	
FMHT65385-0	FATMAX Screwdriver Torx T30 × 125 mm tamperproof	X	6	3 2 5 3 5 6 0 1 6 5 3 8 5 9	
FMHT65386-0	FATMAX Screwdriver Torx T40 × 125 mm tamperproof	X	6	3 2 5 3 5 6 0 1 6 5 3 8 6 6	

FATMAX® 5 PCS SCREWDRIVER SET PARALLEL/STANDARD FLAT/PHILLIPS

STANLEY
FATMAX



- Parallel 3.5×75mm, 5.5×125mm
- Standard flat 8 × 100mm
- Phillips PH1×100mm, PH2×125mm

CODE	DESCRIPTION				PRICE
0-65-436*	FATMAX Screwdriver set 5-pcs St/Par/Ph*	X	6	3 2 5 3 5 6 0 1 6 5 4 3 6 8	

**Not in the Nordic assortment - special order required. Minimum order quantity applied.*

FATMAX® 5 PCS SCREWDRIVERPARALLEL/PHILLIPS DRIVER SET

STANLEY
FATMAX



- Parallel 3.5 × 75mm, 4 × 100mm, 5.5 × 125mm
- Phillips PH1×100mm, PH2×125mm

CODE	DESCRIPTION				PRICE
0-65-440	FATMAX Screwdriver set 5 Pcs Par/Ph	X	6	3 2 5 3 5 6 0 1 6 5 4 4 0 5	

FATMAX® 6 PCS SCREWDRIVER SET TORX

STANLEY
FATMAX



- Torx T10×75mm, T15×75mm, T20×100mm, T25×100mm, T30×125mm, T40×125mm

CODE	DESCRIPTION				PRICE
0-65-099	FATMAX Screwdriver set 6-pcs Torx	X	6	3 2 5 3 5 6 0 1 6 5 0 9 9 5	

FATMAX® 6 PCS SCREWDRIVER SET PHILLIPS

STANLEY
FATMAX



- Content: 3.5×75, 4×100, 5.5×125, PH0, PH1 & PH2

CODE	DESCRIPTION				PRICE
FMHT0-62626*	FATMAX Screwdriver set 6-pcs PH*	X	6	3 2 5 3 5 6 0 1 6 2 6 2 6 6	

**Not in the Nordic assortment - special order required. Minimum order quantity applied.*

FATMAX® 6 PCS SCREWDRIVER SET POZIDRIV

STANLEY
FATMAX

- Parallel 3.5×75mm, 5.5×150mm
- Standard flat 5.5×100mm, 8×150mm
- Pozidriv PZ1×100, PZ2×125mm



CODE	DESCRIPTION				PRICE
0-65-428*	FATMAX Screwdriver set 6-pcs St/Par/Poz*	X	6	3 253560 654283	

**Not in the Nordic assortment - special order required. Minimum order quantity applied.*

FATMAX® 7 PCS SCREWDRIVER SET PHILLIPS

STANLEY
FATMAX

- Content: 2.5×50, 3.5×75, 4×100, 5.5×125, 6.5×150, PH1 & PH2



CODE	DESCRIPTION				PRICE
FMHT0-62627*	FATMAX Screwdriver set 7-pcs PH*	X	6	3 253560 626273	

**Not in the Nordic assortment - special order required. Minimum order quantity applied.*

FATMAX® 6 PCS SCREWDRIVER SET WITH WATERPUMP PLIER

STANLEY
FATMAX

- Content: 3.5 × 75, 4 × 100, 5.5 × 125, PH1, PH2 & pipe wrench



CODE	DESCRIPTION				PRICE
FMHT0-62639	FATMAX Screwdriver set Water pump plier 6 pcs	X	6	3 253560 626396	

FATMAX® 7 PCS SCREWDRIVER SET POZIDRIV

STANLEY
FATMAX

- Parallel 3.5×75mm, 3×100mm
- Standard flat 5.5×100mm, 8×150mm
- Pozidriv PZ0 × 75mm, PZ1 × 100mm, PH2 × 125mm



CODE	DESCRIPTION				PRICE
0-65-425	FATMAX Screwdriver set 7-pcs St/Par/Poz	X	6	3 253560 654252	

FATMAX® 7 PCS SCREWDRIVER SET PHILLIPS/POZIDRIV

STANLEY
FATMAX

- Parallel 3.5×75mm, 5.5×125mm
- Standard flat 6.5 × 150mm
- Phillips PH1×100mm, PH2×125mm
- Pozidriv PZ1 × 100mm PZ2 × 125mm



CODE	DESCRIPTION				PRICE
0-65-438	FATMAX Screwdriver set 7-pcs St/Par/Ph/Poz	X	6	3 253560 654382	

FATMAX® 8 PCS SCREWDRIVER SET PHILLIPS

STANLEY
FATMAX

- Parallel 3.5×75mm, 5.5×125mm
- Standard flat 4 × 100mm, 6.5 × 150mm, 8 × 150mm
- Phillips PH0 × 75mm, PH1 × 100mm, PH2 × 125mm



CODE	DESCRIPTION				PRICE
0-65-437	FATMAX Screwdriver set 8-pcs St/Par/Ph	X	6	3 253560 654375	

FATMAX® 9 PCS SCREWDRIVER SET POZIDRIV

STANLEY
FATMAX



- Parallel 3 × 50mm, 4 × 100mm, 6.5 × 30mm
- Standard flat 5.5 × 100mm, 6.5 × 150mm, 8 × 150mm
- Pozidriv PZ0 × 75mm, PZ1 × 100mm, PZ2 × 100mm

CODE	DESCRIPTION	☐	☒	☐	PRICE
FMHT65424-0*	FATMAX Screwdriver set 9-pcs St/Par/Poz*	X	10	3	2 5 3 5 6 1 1 6 5 4 2 4 4

*Not in the Nordic assortment - special order required. Minimum order quantity applied.

FATMAX® 10 PCS SCREWDRIVER SET PHILLIPS

STANLEY
FATMAX



- Parallel 3 × 50mm, 4 × 100mm
- Standard flat 5.5 × 100mm, 6.5 × 150mm, 8 × 150mm
- Phillips PH00 × 50mm, PH0 × 75mm, PH1 × 100mm, PH2 × 125mm
- Voltage tester

CODE	DESCRIPTION	☐	☒	☐	PRICE
FMHT65439-0*	FATMAX Screwdriver set 10-pcs St/Par/Ph/Voltage tester	X	10	3	2 5 3 5 6 1 1 6 5 4 3 9 8 51.50

*Not in the Nordic assortment - special order required. Minimum order quantity applied.

FATMAX® 12 PCS SCREWDRIVER SET PHILLIPS/POZIDRIV

STANLEY
FATMAX



- Parallel 2.5 × 50mm, 4 × 100mm, 5.5 × 150mm, 6.5 × 30mm
- Standard flat 5.5×100mm, 8×150mm
- Phillips PH0 × 75mm, PH1 × 100mm, PH2 × 125mm
- Pozidriv PZ0 × 75mm, PH1 × 100mm, PZ2 × 125mm

CODE	DESCRIPTION	☐	☒	☐	PRICE
FMHT65426-0*	FATMAX Screwdriver set 12-pcs St/Par/Ph/Poz*	X	10	3	2 5 3 5 6 1 1 6 5 4 2 6 8

*Not in the Nordic assortment - special order required. Minimum order quantity applied.

FATMAX® BOLSTER SCREWDRIVERS

FATMAX® BOLSTER SCREWDRIVERS STANDARD FLAT

STANLEY
FATMAX



- Additional hex Bolster for high torque applications - use with an open end spanner
- Large diameter handle for excellent torque transmission and grip
- With soft-grip handle for comfortable use and color coded for quick selection of the right screwdriver
- Chrome vanadium steel blade for high resistance and limited risk of tip breakage
- Sandblasted tip for better screw grip and longer life

CODE	DESCRIPTION	☐	☒	☐	PRICE
FMHT0-62619	FATMAX Bolster Standard flat 6.5 × 150mm	X	6	3	2 5 3 5 6 0 1 6 2 6 1 9 8
FMHT0-62620	FATMAX Bolster Standard flat 8 × 175 mm	X	6	3	2 5 3 5 6 0 1 6 2 6 2 0 4
FMHT0-62621	FATMAX Bolster Standard flat 10 × 200 mm	X	6	3	2 5 3 5 6 0 1 6 2 6 2 1 1

FATMAX® BOLSTER SCREWDRIVER PHILLIPS

STANLEY
FATMAX



- Use more force when screwdriving thanks to the attachment
- Large diameter handle for excellent torque transmission and grip
- With soft-grip handle for comfortable use and color coded for quick selection of the right screwdriver
- Chrome vanadium steel blade for high resistance and limited risk of tip breakage
- Sandblasted tip for better screw grip and longer life

CODE	DESCRIPTION	☐	☒	☐	PRICE
FMHT0-62622	FATMAX Bolster Screwdriver PH2 × 125 mm	X	6	3	2 5 3 5 6 0 1 6 2 6 2 2 8
FMHT0-62623	FATMAX Bolster Screwdriver PH3 × 150 mm	X	6	3	2 5 3 5 6 0 1 6 2 6 2 3 5

FATMAX® BOLSTER SCREWDRIVER POZIDRIV

STANLEY
FATMAX



- Additional hex Bolster for high torque applications - use with an open end spanner
- Large diameter handle for excellent torque transmission and grip
- With soft-grip handle for comfortable use and color coded for quick selection of the right screwdriver
- Chrome vanadium steel blade for high resistance and limited risk of tip breakage
- Sandblasted tip for better screw grip and longer life

CODE	DESCRIPTION	☐	☒	☐	PRICE
FMHT0-62624	FATMAX Bolster Screwdriver PZ2 × 125 mm	X	6	3	2 5 3 5 6 0 1 6 2 6 2 4 2
FMHT0-62625	FATMAX Bolster Screwdriver PZ3 × 150 mm	X	6	3	2 5 3 5 6 0 1 6 2 6 2 5 9

PRACTICAL INFO

FATMAX® SCREWDRIVERS VDE

- High quality steel blade
- Black oxidized tip for extra protection
- Polyamide protective layer
- Guaranteed up to 1000 Volts
- Red handle (VDE)
- Identification on the handle



**STANLEY
FATMAX
BORNEO Tip**
For a better grip and fewer
damaged screws



FATMAX® VDE SCREWDRIVERS

FATMAX® SCREWDRIVERS PARALLEL VDE

**STANLEY
FATMAX**

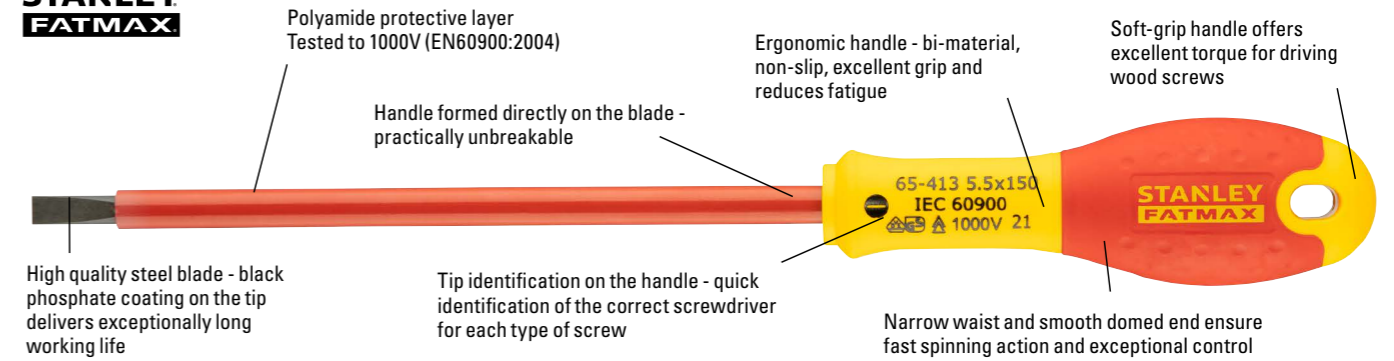

CODE	DESCRIPTION	✉	☒	📊	PRICE
0-65-410	FATMAX Screwdriver Parallel VDE 2.5 x 50 mm	X	6	3 2 5 3 5 6 0 1 1 6 5 4 1 0 8	
1-65-410*	FATMAX Screwdriver Parallel VDE 2.5 x 50 mm*	-	6	3 2 5 3 5 6 1 1 6 5 4 1 0 7	
0-65-411	FATMAX Screwdriver Parallel VDE 3.5 x 75 mm	X	6	3 2 5 3 5 6 0 1 1 6 5 4 1 1 5	
1-65-411*	FATMAX Screwdriver Parallel VDE 3.5 x 75 mm*	-	6	3 2 5 3 5 6 1 1 6 5 4 1 1 4	
0-65-412	FATMAX Screwdriver Parallel VDE 4 x 100 mm	X	6	3 2 5 3 5 6 0 1 1 6 5 4 1 2 2	
1-65-412*	FATMAX Screwdriver Parallel VDE 4 x 100 mm*	-	6	3 2 5 3 5 6 1 1 6 5 4 1 2 1	
0-65-413	FATMAX Screwdriver Parallel VDE 5.5 x 150 mm	X	6	3 2 5 3 5 6 0 1 1 6 5 4 1 3 9	
1-65-413*	FATMAX Screwdriver Parallel VDE 5.5 x 150 mm*	-	6	3 2 5 3 5 6 1 1 6 5 4 1 3 8	

*Not in the Nordic assortment - special order required. Minimum order quantity applied.

STANLEY® FATMAX® VDE MULTI-BIT 10 PIECE SCREWDRIVER SET IN POUCH

**STANLEY
FATMAX**



- Heat-treated tips deliver improved torque, corrosion protection and long working life
- Heavy-duty plastic sheath insulation runs the full length of the bar to protect the user from live current. VDE compliant and certified to 1,000V for professional applications
- Large diameter, comfortable soft-grip handle provides excellent torque for driving screws
- 10 piece set that includes: Tip blades – 1 x Slotted 3.5mm, 1 x Slotted 5.5mm, 1 x 1-Point Phillips, 1 x 2-Point Phillips, 1 x Pozi 1, 1 x Pozi 2, mains tester (125-250V), large and small handles, compact and durable tool pouch

CODE	DESCRIPTION	✉	☒	📊	PRICE
FMHT66426-0	STANLEY® FATMAX® VDE Multi-Bit 10 Piece Screwdriver Set In Pouch	X	-	3253560664268	

NEW



FATMAX® SCREWDRIVERS PHILLIPS VDE

STANLEY
FATMAX



CODE	DESCRIPTION				PRICE
0-65-414	FATMAX Screwdriver Phillips VDE PH0 × 75 mm	X	6	3	2 5 3 5 6 0 1 6 5 4 1 4 6
1-65-414*	FATMAX Screwdriver Phillips VDE PH0 × 75 mm*	-	6	3	2 5 3 5 6 1 1 6 5 4 1 4 5
0-65-415	FATMAX Screwdriver Phillips VDE PH1 × 100 mm	X	6	3	2 5 3 5 6 0 1 6 5 4 1 5 3
1-65-415*	FATMAX Screwdriver Phillips VDE PH1 × 100 mm*	-	6	3	2 5 3 5 6 1 1 6 5 4 1 5 2
0-65-416	FATMAX Screwdriver Phillips VDE PH2 × 125 mm	X	6	3	2 5 3 5 6 0 1 6 5 4 1 6 0
1-65-416*	FATMAX Screwdriver Phillips VDE PH2 × 125 mm*	-	6	3	2 5 3 5 6 1 1 6 5 4 1 6 9

*Not in the Nordic assortment - special order required. Minimum order quantity applied.

FATMAX® SCREWDRIVERS POZIDRIV VDE

STANLEY
FATMAX



CODE	DESCRIPTION				PRICE
0-65-417	FATMAX Screwdriver Pozidriv VDE PZ0 × 75 mm	X	6	3	2 5 3 5 6 0 1 6 5 4 1 7 7
1-65-417*	FATMAX Screwdriver Pozidriv VDE PZ0 × 75 mm*	-	6	3	2 5 3 5 6 1 1 6 5 4 1 7 6
0-65-418	FATMAX Screwdriver Pozidriv VDE PZ1 × 100 mm	X	6	3	2 5 3 5 6 0 1 6 5 4 1 8 4
1-65-418*	FATMAX Screwdriver Pozidriv VDE PZ1 × 100 mm*	-	6	3	2 5 3 5 6 1 1 6 5 4 1 8 3
0-65-419	FATMAX Screwdriver Pozidriv VDE PZ2 × 125 mm	X	6	3	2 5 3 5 6 0 1 6 5 4 1 9 1
1-65-419*	FATMAX Screwdriver Pozidriv VDE PZ2 × 125 mm*	-	6	3	2 5 3 5 6 1 1 6 5 4 1 9 0

*Not in the Nordic assortment - special order required. Minimum order quantity applied.

FATMAX® SCREWDRIVERS VDE BORNEO - PHILLIPS & POZI

STANLEY
FATMAX



- VDE Borneo Screwdrivers for a better grip and less damaged on the screw
- Insulated blade for safety - all STANLEY® VDE screw drivers are tested to 10,000 volts and guaranteed safe to 1,000 volts
- Soft-grip handle for comfortable use

CODE	DESCRIPTION				PRICE
FMHT0-62649	FATMAX Screwdriver set VDE Borneo Pozi PZ1 & PZ2 × 125mm	X	6	3	2 5 3 5 6 0 1 6 2 6 4 9 5
FMHT0-62648	FATMAX Screwdriver set VDE Borneo 2 pcs: PH1 x 100mm & PH2 x 125mm	X	6		3253560626488

FATMAX® 6 PCS SCREWDRIVER SET VDE - PHILLIPS

STANLEY
FATMAX

- Content: Parallel 2.5 × 50 mm, 3.5 × 75 mm, 5.5 × 150 mm - Phillips 1 × 100 mm, 2 × 125 mm - Voltage tester 3 × 64 mm



CODE	DESCRIPTION				PRICE
0-65-441	FATMAX Screwdriver set VDE 6 Pcss - Par/Ph/Voltage tester	X	6	3	2 5 3 5 6 0 1 6 5 4 4 1 2

FATMAX® 6 PCS SCREWDRIVER SET VDE - POZIDRIV

STANLEY
FATMAX

- Content: Parallel 2.5 × 50 mm, 3.5 × 75 mm, 5.5 × 150 mm - Pozidriv 1 × 100 mm, 2 × 125 mm - Voltage tester 3 × 64 mm



CODE	DESCRIPTION				PRICE
0-65-443	FATMAX Screwdriver set VDE 6 Pcss - Par/Poz/Voltage tester	X	6	3	2 5 3 5 6 0 1 6 5 4 4 3 6

FATMAX® 10 PCS SCREWDRIVER SET VDE - PHILLIPS/POZIDRIV

STANLEY
FATMAX



· Content: Parallel 2.5 x 50 mm, 3.5 x 75 mm, 5.5 x 150 mm -Phillips 0 x 75 mm, 1 x 100 mm, 2 x 125 mm - Pozidriv 0 x 75 mm, 1 x 100 mm , 2 x 125 mm - Voltage tester 3 x 64 mm

CODE	DESCRIPTION	☐	☒	☐	PRICE
FMHT62573-0*	FATMAX Screwdriver set VDE 10-pcs -Par/Ph/Poz/Voltage tester*	X	6	3 2 5 3 5 6 1 1 6 2 5 7 3 2	

*Not in the Nordic assortment - special order required. Minimum order quantity applied.

FATMAX® 5 PCS PRO SCREWDRIVER SET VDE - NARROW TIP

STANLEY
FATMAX



- VDE Borneo Screwdrivers for a better grip and less damaged on the screw
- Insulated blade for safety - all STANLEY® VDE screwdrivers are tested to 10,000 volts and guaranteed safe to 1,000 volts
- Soft-grip handle for comfortable use
- Narrow tip

CODE	DESCRIPTION	☐	☒	☐	PRICE
XTHT0-62692*	FATMAX Pro Screwdriver set VDE 5 Pcs - PH Narrow Tip*	X	6	3 2 5 3 5 6 0 1 6 2 6 9 2 1	
XTHT0-62693*	FATMAX Pro Screwdriver set VDE 5 Pcs - PZ Narrow Tip*	X	6	3 2 5 3 5 6 0 1 6 2 6 9 3 8	

*Not in the Nordic assortment - special order required. Minimum order quantity applied.

VDE SCREWDRIVER SETS



- Moulded handle to bar connection for longer life and more torque transfer from handle to screw
- Thinner towards the tip of the screwdriver
- Chrome vanadium bar
- VDE & GS qualified - Tested to 10,000V, rated to 1,000V AC
- Conforms to DIN/ ANSI regulations and is usable in all industries
- Lanyard hang hole for easy storage and for applying more torque

STHT60030-0:	Pozi: P22 x 100mm , Slotted: 4.0 x 100mm				
STHT65556-0:	3 x Slotted: 0.4 x 2.5 x 75mm, 0.8 x 4.0 x 100mm and 1.0 x 5.5 x 125mm 2 x Pozidriv: P21 x 80mm and P22 x 100mm				
STHT60031-0:	4 x Slotted: 2.5mm x 75mm, 3.5mm x 75mm, 4mm x 100mm, 5.5 x 125mm 2 x Pozidriv: P21 x 80mm, P22x 100mm, Voltage Tester				

CODE	DESCRIPTION	☐	☒	☐	PRICE
STHT60030-0	VDE Pozi and Slotted Screwdriver Set - 2 pcs	X	-	3253560600303	
STHT65556-0	VDE Screwdriver Set - 5 pcs	X	-	3253560655563	
STHT60031-0	VDE Screwdriver Set - 7 pcs	X	-	3253560600310	

CUSHION GRIP SCREWDRIVERS

CUSHIONGRIP SCREWDRIVERS STANDARD FLAT

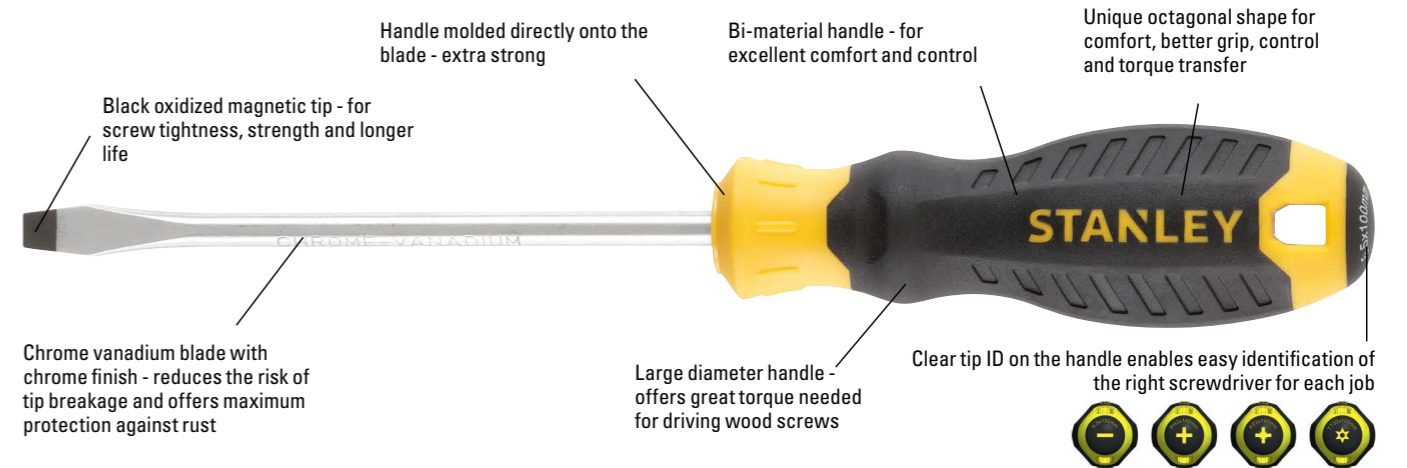

CODE	DESCRIPTION	☐	☒	☐	PRICE
STHT16146-0	Cusion grip Screwdriver Standard flat 5.5 x 100 mm	X	12	3 2 5 3 5 6 0 1 6 1 4 6 0	
STHT16148-0	Cusion grip Screwdriver Standard flat 6.5 x 150 mm	X	12	5 0 5 4 9 0 5 1 3 1 6 1 0 5	
STHT16149-0	Cusion grip Screwdriver Standard flat 8 x 150 mm	X	12	3 2 5 3 5 6 0 1 6 1 4 9 1	
STHT16150-0*	Cusion grip Screwdriver Standard flat 10 x 200 mm*	X	12	3 2 5 3 5 6 0 1 6 1 5 0 7	

*Not in the Nordic assortment - special order required. Minimum order quantity applied.



CUSHIONGRIP SCREWDRIVERS STANDARD FLAT STUBBY



CODE	DESCRIPTION	☐	☒	☐	PRICE
STHT16147-0*	Cusion grip Screwdriver Standard flat 6.5 x 45 mm*	X	12	5 0 5 4 9 0 5 1 3 1 7 3 0 0	

*Not in the Nordic assortment - special order required. Minimum order quantity applied.

CUSHIONGRIP SCREWDRIVERS PARALLEL



CODE	DESCRIPTION	☐	☒	☐	PRICE
STHT16151-0*	Cusion grip Screwdriver Parallel 2.5 x 60 mm*	X	12	3 2 5 3 5 6 0 1 6 1 5 1 4	
STHT16152-0*	Cusion grip Screwdriver Parallel 3.5 x 75 mm*	X	12	3 2 5 3 5 6 0 1 6 1 5 2 1	
STHT16195-0*	Cusion grip Screwdriver Parallel 4 x 100 mm*	X	12	3 2 5 3 5 6 0 1 6 1 9 5 8	

*Not in the Nordic assortment - special order required. Minimum order quantity applied.

CUSHIONGRIP SCREWDRIVERS PHILLIPS



CODE	DESCRIPTION				PRICE
STHT16153-0	Cushion grip Screwdriver Phillips PH0 x 60 mm	X	12		
STHT16155-0	Cushion grip Screwdriver Phillips PH1 x 75 mm	X	12		
STHT16158-0	Cushion grip Screwdriver Phillips PH2 x 100 mm	X	12		
STHT16159-0	Cushion grip Screwdriver Phillips PH3 x 150 mm	X	12		

NEW

CUSHIONGRIP SCREWDRIVERS PHILLIPS STUBBY



CODE	DESCRIPTION				PRICE
STHT16154-0*	Cushion grip Screwdriver Phillips PH1 x 45 mm*	X	12		
STHT16157-0*	Cushion grip Screwdriver Phillips PH2 x 45 mm*	X	12		

*Not in the Nordic assortment - special order required. Minimum order quantity applied.

NEW

CUSHIONGRIP SCREWDRIVERS POZIDRIV



CODE	DESCRIPTION				PRICE
STHT16161-0	Cushion grip Screwdriver Pozidriv PZ0 x 60 mm	X	12		
STHT16162-0	Cushion grip Screwdriver Pozidriv PZ1 x 75 mm	X	12		
STHT16196-0*	Cushion grip Screwdriver Pozidriv PZ2 x 45 mm*	X	12		
STHT16163-0	Cushion grip Screwdriver Pozidriv PZ2 x 100 mm	X	12		
STHT16164-0	Cushion grip Screwdriver Pozidriv PZ3 x 150 mm	X	12		

*Not in the Nordic assortment - special order required. Minimum order quantity applied.

NEW

CUSHIONGRIP SCREWDRIVERS TORX



CODE	DESCRIPTION				PRICE
STHT16177-0	Cushion grip Torx T10 x 75 mm	X	12		
STHT16178-0	Cushion grip Torx T15 x 75 mm	X	12		
STHT16179-0	Cushion grip Torx T20 x 100 mm	X	12		
STHT16180-0	Cushion grip Torx T25 x 100 mm	X	12		
STHT16181-0*	Cushion grip Torx TT27 x 100 mm*	X	12		
STHT16182-0	Cushion grip Torx T30 x 100 mm	X	12		

*Not in the Nordic assortment - special order required. Minimum order quantity applied.

NEW

CUSHIONGRIP SCREWDRIVER SET 8 PCS: PH, STANDARD FLAT, PARALLEL



- Phillips: PH0 x 60mm, PH1 x 75mm, PH2 x 45mm, PH2 x 100mm
- Parallel: 3.5x60mm, 4x100mm
- Standard flat: 5.5x100mm, 6.5x45mm

NEW

CODE	DESCRIPTION				PRICE
STHT16167-0	Cushion grip Screwdriver set 8 pcs: PH, Standard flat, Parallel	X	4		

CUSHIONGRIP SCREWDRIVER SET 6 PCS: PZ, PARALLEL, STANDARD FLAT



- Pozidriv: PZ1x75mm, PZ2x100mm
- Parallel: 3.5 x 60mm, 4.0 x 100mm
- Standard flat: 5.5x100mm, 6.5x150mm

NEW

CODE	DESCRIPTION				PRICE
STHT16172-0*	Cushion grip Screwdriver set 6 pcs: PZ, Parallel, Standard flat*	X	4		

*Not in the Nordic assortment - special order required. Minimum order quantity applied.

CUSHION GRIP SCREWDRIVER SET 6 PCS: PH, PARALLEL, STANDARD FLAT, VOLTAGE TESTER



- Phillips: PH1 × 75mm, PH2 × 45mm, PH2 × 100mm
- Parallel: 4.0 × 100mm
- Standard flat: 5.5×100mm, 6.5×45mm

NEW

CODE	DESCRIPTION				PRICE
STHT16166-0	Cushion Grip Screwdriver Set 6 Pcss: PH, Parallel, Standard flat, Voltage Tester	X	4	3 253560 161668	

STANLEY® CUSHION GRIP SCREWDRIVER SET 3 PCS: PH, PZ, STANDARD FLAT



- Phillips: PH2×100mm
- Pozidriv: PZ2 × 100mm
- Standard flat: 6.5 × 150mm

NEW

CODE	DESCRIPTION				PRICE
STHT16168-0*	CushionGrip Screwdriver set 3 pcss: PH, PZ, Standard flat*	X	4	3 253560 161682	

*Not in the Nordic assortment - special order required. Minimum order quantity applied.

CUSHIONGRIP SCREWDRIVER SET 6 PCS: PH, PARALLEL, STANDARD FLAT



- Phillips: PH1×75mm, PH2×100mm
- Parallel: 3.5 × 60mm, 4.0 × 100mm
- Standard flat: 5.5×100mm, 6.5×150mm

NEW

CODE	DESCRIPTION				PRICE
STHT16165-0*	CushionGrip Screwdriver set 6 pcss: PH, Parallel, Standard flat*	X	4	3 253560 161651	

*Not in the Nordic assortment - special order required. Minimum order quantity applied.

CUSHIONGRIP SCREWDRIVER SET 10-PCS STANDARD FLAT/PHILLIPS



- Standard flat: 6.5 × 45mm, 8 × 150mm, 3 × 75mm, 6.5 × 150mm, 5 × 100mm
- Phillips: #2 × 45mm, #1 × 100mm, #2 × 100mm, #0 × 60mm, #3 × 150mm

CODE	DESCRIPTION				PRICE
2-65-005*	CushionGrip Screwdriver set 10-pcs St/Ph*	X	6	3 253562 650054	

*Not in the Nordic assortment - special order required. Minimum order quantity applied.

STANLEY® CUSHIONGRIP SCREWDRIVER SET 4 PCSS: PH, STANDARD FLAT



- Phillips: PH1×75mm, PH2×100mm
- Standard flat: 5.5×100mm, 6.5×150mm

NEW

CODE	DESCRIPTION				PRICE
STHT16169-0	CushionGrip Screwdriver set 4 pcss: PH, Standard flat	X	24	3 253560 650131	

CUSHIONGRIP SCREWDRIVER SET 10-PCS STANDARD FLAT/POZIDRIV



- Standard flat 3 × 75mm, 5 × 100mm, 6.5 × 45mm, 6.5 × 100mm, 8 × 150mm
- Pozidriv PZ0 × 60mm, PZ1 × 75mm, PZ2 × 45mm, PZ2 × 100mm, PZ3 × 150mm

CODE	DESCRIPTION				PRICE
2-65-014	CushionGrip Screwdriver set 10-pcs St/Pz	X	6	3 253562 650146	

SCREWDRIVERS ESSENTIAL

STANLEY® SCREWDRIVER ESSENTIALS

- Essential™ series screwdriver, combines good quality for everyday use and low price
- Chrome vanadium bar for strength and corrosion resistance
- Essential screwdriver for everyday use
- Hanging hole



CODE	DESCRIPTION	☐	☒	📊	PRICE
STHT0-60273	Stanley Essential screwdriver pozidriv PZ0 x 50mm carded	X	6	3253560602734	
STHT0-60274	Stanley Essential screwdriver pozidriv PZ1 x 100mm carded	X	6	3253560602741	
STHT0-60275	Stanley Essential screwdriver pozidriv PZ2 x 30mm Stubby carded	X	6	3253560602758	
STHT0-60276	Stanley Essential screwdriver pozidriv PZ2 x 100mm carded	X	6	3253560602765	
STHT0-60280	Stanley Essential screwdriver Phillips PH0 x 50mm carded	X	6	3253560602802	
STHT0-60308	Stanley Essential screwdriver Phillips PH1 x 100mm carded	X	6	3253560603083	
STHT0-60329	Stanley Essential screwdriver Phillips PH2 x 30mm Stubby carded	X	6	3253560603298	
STHT0-60335	Stanley Essential screwdriver Phillips PH2 x 100mm carded	X	6	3253560603359	
STHT0-60358	Stanley Essential screwdriver Parallel 4mm x 100mm carded	X	6	3253560603588	
STHT0-60378	Stanley Essential screwdriver Parallel 3mm x 75mm carded	X	6	3253560603786	
STHT0-60389	Stanley Essential screwdriver Flared 5,5mm x 150mm carded	X	6	3253560603892	
STHT0-60401	Stanley Essential screwdriver Flared 6,5mm x 30mm Stubby carded	X	6	3253560604011	
STHT0-60413	Stanley Essential screwdriver Flared 6,5mm x 150mm carded	X	6	3253560604134	

SCREWDRIVERS ESSENTIAL - SETS

STANLEY® SCREWDRIVER SET ESSENTIAL 6 PCS



- Screwdriver for daily use
- Soft handle for comfort
- Chrome vanadium blade for strength and corrosion resistance
- Hardened tip for longer life
- Content: (STHT0-60208): PH0 x 50mm, PH1 x 75mm, PH2 x 100mm, Standard flat 5.5 x 100mm, 6.5 x 150mm, Parallel 3 x 75mm
- Content: (STHT0-60209): PH1 x 75mm, PH2 x 100mm, Standard flat 5.5 x 100mm, 8 x 175mm, Parallel 4 x 100mm, 6.5 x 150mm

CODE	DESCRIPTION	☐	☒	📊	PRICE
STHT0-60208*	Screwdriver set Essential 6 pcs*	-	24	3 253560 602086	
STHT0-60209	Screwdriver set Essential 6 pcs	-	24	3 253560 602093	

*Not in the Nordic assortment - special order required. Minimum order quantity applied.

STANLEY® SCREWDRIVER SET ESSENTIAL 8 PCS



- Screwdriver for daily use
- Soft handle for comfort
- Chrome vanadium blade for strength and corrosion resistance
- Hardened tip for longer life
- Content: PH0 x 50mm, PH1 x 75mm, PH2 x 100mm, Standard flat 3 x 75mm, 5.5 x 100mm, 8 x 175mm, Parallel 4 x 100mm, 6.5 x 150mm

CODE	DESCRIPTION	☐	☒	📊	PRICE
STHT0-60210*	Screwdriver set Essential 8 pcs*	-	24	3 253560 602109	

*Not in the Nordic assortment - special order required. Minimum order quantity applied.

STANLEY® SCREWDRIVER SET ESSENTIAL 10 PCS



- Screwdriver for daily use
- Soft handle for comfort
- Chrome vanadium blade for strength and corrosion resistance
- Hardened tip for longer life
- Content: PH0 x 50mm, PH1 x 75mm, PH2 x 100mm, Standard flat 5.5 x 100mm, 8 x 175mm, Parallel 3 x 75mm, 4 x 100mm, 6.5 x 150mm, PZ1 x 100mm, PZ2x100mm

CODE	DESCRIPTION	☐	☒	📊	PRICE
STHT0-60211*	Screwdriver set Essential 10 pcs*	-	16	3 253560 602116	

*Not in the Nordic assortment - special order required. Minimum order quantity applied.

STANLEY® SCREWDRIVER SET ESSENTIAL 12 PCS



- Screwdriver for daily use
- Soft handle for comfort
- Chrome vanadium blade for strength and corrosion resistance
- Hardened tip for longer life
- Content: PH1 x 75mm, PH2 x 100mm, Standard flat 5.5 x 100mm, 6.5 x 150mm, 8 x 175mm, Parallel 4 x 100mm, 5.5 x 100mm, PZ1 x 100mm, PZ2 x 100mm, T15 x 100mm, T20 x 100mm, T25 x 100mm

CODE	DESCRIPTION				PRICE
STHT0-60212*	Screwdriver set Essential 12 pcs*	-	12		

*Not in the Nordic assortment - special order required. Minimum order quantity applied.

STANLEY® SCREWDRIVER SET ESSENTIAL 20 PCS



- Screwdriver for daily use
- Soft handle for comfort
- Chrome vanadium blade for strength and corrosion resistance
- Hardened tip for longer life
- Content: PH0 x 50mm, PH1 x 75mm, PH2 x 100mm (x2), Standard flat 5.5 x 100mm (x2), 6.5 x 150mm (x2), 8 x 175mm, Parallel 2.5 x 50mm, 3 x 75mm (x2), 4 x 100mm (x2), PZ1 x 100mm, PZ2 x 100mm (x2), T10 x 100mm, T15 x 100mm, T20 x 100mm

CODE	DESCRIPTION				PRICE
STHT0-60213	Screwdriver set Essential 20 pcss	-	8		

SPECIALITY SCREWDRIVERS

STANLEY® FATMAX® AWL



- Suitable for making holes in wood before drilling and screwing
- Ergonomic handle
- Awl 0 x 75 mm

CODE	DESCRIPTION				PRICE
0-65-491	FATMAX Awl 0 x 75 mm	X	6		

STANLEY® BRADAWL



- Hardened, tempered and sharpened blades for efficient performance
- Plastic sleeve for effortless pushing and turning
- Rust resistant Nickel plating
- Textured handle for improved grip

CODE	DESCRIPTION				PRICE
0-69-014	Stanley Awl 32 x 2 mm	X	6	3253560690144	

FATMAX® VOLTAGE TESTER

STANLEY FATMAX



- Non-conductive up to 250V
- Complies with VDE, GSE and CE Standard
- Belt clip for comfort and easy storage (not on STHT0-62685)
- Visible flashing light when electrical current is detected

CODE	DESCRIPTION				PRICE
FMHT0-64985	FATMAX Voltage tester 220V-250V - tip 3.5 mm	X	36		

STANLEY® VOLTAGE TESTER 220V-250V



- Non-conductive up to 250V
- Complies with VDE, GSE and CE Standard flats
- Belt clip for comfort and easy storage (not on STHT0-62685)
- Visible flashing light when electrical current is detected

CODE	DESCRIPTION				PRICE
STHT0-66121	Voltage tester 220V-250V - tip 3.5 mm	X	6		
STHT0-62685	Extra Long Voltage tester 105 mm	X	6		

PRECISION SCREWDRIVERS

STANLEY® PRECISION SCREWDRIVER MULTIBIT 8 PCS



- Multibit set with convenient storage of bits in the handle
- Precise clamp for holding bits
- In accordance with the relevant DIN & ISO Standards
- Soft-grip handle for greater comfort and optimal control
- Supplied in convenient, reusable storage box
- Content: Parallel 1, 1.2, 1.5, 1.8, 2, 2.5 & PH000, PH00

CODE	DESCRIPTION				PRICE
STHT0-62629*	Precision screwdriver Multibit 8 pcs	X	6	3 253560 626297	

*Not in the Nordic assortment - special order required. Minimum order quantity applied.

STANLEY® PRECISION SCREWDRIVER MULTIBIT 16 PCS



- Multibit set with convenient storage of bits in the handle
- Precise clamp for holding bits
- In accordance with the relevant DIN & ISO Standards
- Soft-grip handle for greater comfort and optimal control
- Supplied in handy storage box
- Content: Parallel 1, 1.2, 1.5, 1.8, 2, 2.5 & PH000, PH00 & T5, T6, T7, T8 & Hex 0.9, 1.3, 1.5, 2

CODE	DESCRIPTION				PRICE
STHT0-62633*	Precision screwdriver Multibit 16 pcs	X	6	3 253560 626334	

*Not in the Nordic assortment - special order required. Minimum order quantity applied.

STANLEY® PRECISION TURNER HEX BIT 32 PCS



- Multibit set with convenient storage of bits in the handle
- Precise clamp for holding bits
- In accordance with the relevant DIN & ISO Standards
- Soft-grip handle for greater comfort and optimal control
- Supplied in a handy storage box
- Content: Parallel 1, 1.2, 1.5, 1.8, 2, 2.5, 3 & PH000, PH00, PH0 & PZ0, PZ1 & T5, T6, T7, T8, T9 & Hex 0.9, 1.3, 1.5, 2, 2.5, 3, 4 & T10, T15, T20 & Triwing 2, 3, 4 & Square 2, 3

CODE	DESCRIPTION				PRICE
STHT0-62634*	Precision Turner 32 Pcs Hex	X	6	3 253560 626341	

*Not in the Nordic assortment - special order required. Minimum order quantity applied.

STANLEY® PRECISION SCREWDRIVER SET 4 PCS TORX



- Multibit set with convenient storage of bits in the handle
- Precise clamp for holding bits
- In accordance with the relevant DIN & ISO Standards
- Soft-grip handle for greater comfort and optimal control
- Supplied in a handy storage box
- Content: T6, T7, T8, T9

CODE	DESCRIPTION				PRICE
STHT0-62630*	Precision wrench Torx 4 pcs	X	6	3 253560 626303	

*Not in the Nordic assortment - special order required. Minimum order quantity applied.

STANLEY® PRECISION SCREWDRIVER SET 6 PCS 1-1.8



- Multibit set with convenient storage of bits in the handle
- Precise clamp for holding bits
- In accordance with the relevant DIN & ISO Standards
- Soft-grip handle for greater comfort and optimal control
- Supplied in a handy storage box
- Content: Parallel 1, 1.2, 1.5, 1.8 & PH000, PH00

CODE	DESCRIPTION				PRICE
STHT0-62631*	Precision screwdriver set 6 Pcs 1-1.8	X	6	3 253560 626310	

*Not in the Nordic assortment - special order required. Minimum order quantity applied.

STANLEY® PRECISION SCREWDRIVER SET 6 PCS 2-3



- Multibit set with convenient storage of bits in the handle
- Precise clamp for holding bits
- In accordance with the relevant DIN & ISO Standards
- Soft-grip handle for greater comfort and optimal control
- Supplied in a convenient storage box
- Content: Parallel 2, 2.5, 3 & PH000, PH00, PHO

CODE	DESCRIPTION				PRICE
STHT0-62632*	Precision screwdriver set 6 pcs 2-3	X	6	3 253560 626327	

*Not in the Nordic assortment - special order required. Minimum order quantity applied.

FATMAX® PRECISION SCREWDRIVER SET 6 PCS

STANLEY
FATMAX



- Ergonomic handle
- Parallel 3x100, 3x50, 2.5x50 - Phillips PH00x50, PH0x75 - Pozidriv PZ0x75

CODE	DESCRIPTION	☐	☒	☐	PRICE
0-65-492*	FATMAX Precision screwdriver Set 6 pcs	X	6	3 253560 654924	

*Not in the Nordic assortment - special order required. Minimum order quantity applied.

STANLEY® PRECISION INSTRUMENT SCREWDRIVER SET 6 PCS



- Complete set of 6 screwdrivers with hexagonal handle and revolving head
- Nickel-plated, fluted handles for finger tip control and rust preventions
- Tempered and blued steel for long life
- Parallel 1.4, 2, 2.4, 3mm
- Pozidriv PZ0, PZ1

CODE	DESCRIPTION	☐	☒	☐	PRICE
1-66-039	Precision Instrument Screwdriver set 6 pcs	X	6	3 253561 660399	

STANLEY® CUSHIONGRIP PRECISION SCREWDRIVER SET 6 PCS



- Bi-material handles designed for easy and comfortable grip
- Soft cushion grip for comfort
- Swivel-head handles provide precision and reach
- Magnetic tip
- Colour coded ends for instant identification of the right screwdriver
- Parallel 3mm, 2.4mm, 2mm, 1.4mm
- Phillips PH0, PH1

CODE	DESCRIPTION	☐	☒	☐	PRICE
0-66-052	Cushion grip precision Screwdriver set 6 pcs Par/Ph	X	6	0 076174 660524	

STANLEY® PRECISION SCREWDRIVER SET 5-PCS METAL



- Set of precision Screwdrivers with 0.8mm, 1mm, 1.2mm, 1.6mm & 2mm screwdrivers
- Fast rotary movements ensure easy and fast work in precision applications
- Nickel finish for longer life and easy cleaning

CODE	DESCRIPTION	☐	☒	☐	PRICE
STHT0-62686*	Precision screwdriver set 5-pcs Metal	X	6	3 253560 626860	

*Not in the Nordic assortment - special order required. Minimum order quantity applied.

BIT SCREWDRIVERS

STANLEY® FATMAX® RATCHETING SCREWDRIVER

STANLEY
FATMAX



CODE	DESCRIPTION	☐	☒	☐	PRICE
FMHT62692-0	STANLEY® FATMAX® Ratcheting Screwdriver	X	4	5 054905 295615	

STANLEY® FATMAX® 4V POWER ASSIST SCREWDRIVER

STANLEY
FATMAX



- 4V Power Assist Screwdriver operates at up to 300rpm
- 0.9Nm of torque, balanced to complement the speed of operation
- 1.5Ah rechargeable battery for superior runtime (USB cable included)
- 3 colour LED Charge indicator
- Features an integrated magnetic bit holder
- Fits neatly in the hand and can be easily carried in a pocket or toolbox
- Push-button functionality for quick and simple operation. Switches seamlessly between forward and reverse modes with a single key press
- Bits: Philips 1-2mm, Pozidriv 1-2mm, Slotted 4 -5.5mm

CODE	DESCRIPTION	☐	☒	☐	PRICE
FMHT66719-0	STANLEY® FATMAX® 4V Power Assist Screwdriver	X	6	3253560667191	

STANLEY® FATMAX® LED RATCHET SCREWDRIVER

STANLEY
FATMAX



- Fine 45-tooth ratchet delivers extremely high torque with a 9° working arc
- Bi-material handle for grip, comfort and high torque loads
- LED for dark areas - initial brightness: 3.5 Lumens
- Magnetic bit retention prevents bit loss
- 3-position ratchet enables clockwise, anti-clockwise and locked ratcheting
- Content: 5, 6.5, 8, PH1, PH2, PH3, PZ1, PZ2, PZ3, T10, T15 & T20

CODE	DESCRIPTION				PRICE
FMHT0-62689	FATMAX Ratchet Screwdriver LED	X	6		

STANLEY® FATMAX® PISTOL GRIP RATCHET

STANLEY
FATMAX



- Fine 45-tooth ratchet delivers extremely high torque with a 9° working arc
- Bi-material handle for grip, comfort and high torque loads
- 3-position ratchet enables clockwise, anti-clockwise and locked ratcheting
- Pistol grip for higher torque loads
- Content: 5, 6.5, 8, PH1, PH2, PH3, PZ1, PZ2, PZ3, T10, T15 & T20

CODE	DESCRIPTION				PRICE
FMHT0-62691	FATMAX Ratchet Screwdriver Pistol Grip	X	6		

STANLEY® FATMAX® RATCHET SCREWDRIVERS - 7 & W12 BITS

STANLEY
FATMAX



- Fine 45-tooth ratchet delivers extremely high torque with a 9° working arc
- Large soft-grip handle with bit storage for greater comfort and ease of use
- 3-position ratchet enables clockwise, anti-clockwise and locked ratcheting
- Content: 5, 6.5, 8, PH1, PH2, PH3, PZ1, PZ2, PZ3, T10, T15 & T20
- FMHT0-62688: Content: 5, 6.5, PH1, PH2, PZ1 & PZ2

CODE	DESCRIPTION				PRICE
FMHT0-62690	FATMAX Ratchet Screwdriver 12 Bits	X	6		

CODE	DESCRIPTION				PRICE
FMHT0-62688	FATMAX Ratchet Screwdriver Stubby - 7 bits	X	6		

STANLEY® FATMAX® BIT ADAPTOR

STANLEY
FATMAX



- Handle moulded direct to bar virtually unbreakable bond. Highly reliable and providing an extra long life
- Colour coded ends make it easy to identify the correct screwdriver for each screw type
- Chrome vanadium steel bar allows for high torque and reduces the chance of tip breakage
- Smooth domed end for fast spinning action – speed and comfort

CODE	DESCRIPTION				PRICE
0-65-490	FATMAX Bit adaptor x 125mm	X	6		

STANLEY® PISTOL GRIP RATCHET BIT SCREWDRIVER SET 38 PCS



- 1 pistol grip ratchet bit screwdriver
- 1 extension
- 6 long bits: Phillips® n° 1, n° 2, n° 3 - Parallel 5, 6, 7 mm
- 24 Standard flat bits: Phillips® n° 0, n° 1, n° 2 (X3)n° 3 - Parallel 5, 6, 7 mm - Hex 2, 3, 4, 5, 5.5, 6 mm - Square S1, S2, S3 - Torx® T10, T15, T20, T25, T27, T30
- 6 sockets 5, 6, 8, 9, 10, 11mm

CODE	DESCRIPTION				PRICE
0-63-038	Pistol Grip Ratchet Bit screwdriver Set 38 pcs	X	6		

STANLEY® PISTOL GRIP RATCHET BIT SCREWDRIVER SET 22 PCS



- 1 pistol grip ratchet bit
- 1 extension
- 2 long bits : Phillips® n°2 - Parallel 6 mm
- 12 Standard flat bits : Phillips® n°1, n°2, n°3 - Parallel 5, 6, 7 mm - Torx® T10, T15, T20 - Hex 3, 4, 5 mm
- 6 sockets 5, 6, 8, 9, 10, 11 mm

CODE	DESCRIPTION				PRICE
0-63-022	Pistol Grip Ratchet Bit screwdriver Set 22 pcs	X	6		

MULTI-BIT SCREWDRIVER 35 PCS

- 12x Hex bits: 3x2 - 5x3 - 4 - 5 - 8
- 7x Flat bits: 4 - 4.5 - 5.5 - 6 - 6.5 - 8 mm
- 8x Phillips bits: PH0 - PH1 - PH2x2 - PH3 x2 - PH4 x2
- 7x PZ bits: PZ0 - PZ1 - PZ2 x2 - PZ3 x2 - PZ4
- 6x Torx bits: T10 - T15 - T20 - T25 - T27 - T30
- 21x Tamperproof Torx: 3xTX10 - 3xTX15 - 6xTX20 - 3xTX25 - 3xTX30 - 3xTX40
- 1x Magnetic bit holder 60 mm



CODE	DESCRIPTION				PRICE
STHT0-70885	Multi-bit Screwdriver bits 35 pcs			3253560708856	

MULTI-BIT RATCHETING SCREWDRIVER WITH BITS

- Patented bit storage in handle and cap for ease of visibility, access and security
- Durable bi-material handles for comfortable grip
- Pawl mechanism with three positions (right, left, fixed)
- Parallel 6,5 & 5 mm - Phillips n°1, 2 - Pozidriv n°1, 2 - Torx T10, T15 - Square n°1, 2



CODE	DESCRIPTION				PRICE
0-68-010	Multi-bit ratcheting Screwdriver with bits	X	6	3 2535601680107	

STUBBY MULTI-BIT RATCHETING SCREWDRIVER

- Magnetic bit holder
- Ratcheting mechanism- Right, left and stop
- Smart magazine solution with 6 bits in the cap
- Content: PH1, PH2, PZ1, PZ2, flat 4.5 mm, flat 6 mm



CODE	DESCRIPTION				PRICE
0-66-358	Stubby Multibit Ratcheting Screwdriver	X	3	3 2535601663582	

STUBBY MULTI-BIT SCREWDRIVER

- Magnetic bit holder
- Durable bi-material handle
- Smart magazine solution with 6 bits in the cap
- Content: PH1, PH2, PZ1, PZ2, St 4.5 mm, St 6 mm



CODE	DESCRIPTION				PRICE
0-66-357	Stubby Multi-bit Screwdriver	X	3	3 2535601663575	

SCREWDRIVING SET - BITS

STANLEY® FATMAX® 61 PIECE - SL, PH, PZ, T, RT, HEX



- 1/4" bits:
- Slot: 4 - 4.5 - 5.5 - 6 - 6.5 - 8 mm
- PH0 - PH1 - 2 x PH2 - 2 x PH3 - PH4
- PZ1 - 2 x PZ2 - 2 x PZ3 - PH4
- Torx: 10 - 15 - 20 - 25 - 27 - 30
- Resistorx: 3 x T10 - 3 x T15 - 6 x T20 - T25 - T30 - T40
- Hex: 2 x 3 - 4 - 5 - 3 x 6 - 8mm
- Magnetic bit holder 60 mm

CODE	DESCRIPTION				PRICE
1-13-902	STANLEY® bit set 1/4" Bit holder 61-pcs	-	10	3 253561139024	
FMHT1-81017	Stanley FATMAX 61PC Bits set, Display x10	X	10	3253561810176	

STANLEY® BIT SET 1/4" - MAGNETIC BIT HOLDER WITH LOCK-RING 40 PCS



- 1/4" bits:
- Slot: 4 - 5.5 - 6.5 - 8 mm
- PH1 - PH2 - PH3
- PZ1 - PZ2 - PZ3
- Torx: T8 - T10 - T15 - T20 - T25 - T27 - T30 - T40
- Resistorx: T10 - T15 - T20 - T25 - T27 - T30 - T40
- : 3 - 4 - 5 - 6mm
- Magnetic bit holder 60 mm
- 1/4" sockets: 6 - 7 - 8 - 10 - 11 - 12 - 13 mm
- 1/4" ratchet wrench

CODE	DESCRIPTION				PRICE
1-13-906	STANLEY® bit set 1/4" Ratchet wrench 40-pcs	-	10	3 253561139062	

STANLEY® BIT SET 1/4" - RATCHET WRENCH, BIT HOLDER - 40 PCS



- 1/4" bits
- Slot: 4 - 5.5 - 6.5 - 8 mm
- PH1 - PH2 - PH3
- PZ1 - PZ2 - PZ3
- Torx: T8 - T10 - T15 - T20 - T25 - T27 - T30 - T40
- Resistorx: T10 - T15 - T20 - T25 - T27 - T30 - T40
- : 3 - 4 - 5 - 6mm
- Magnetic bit holder lock-ring 60 mm
- 1/4" sockets: 6 - 7 - 8 - 10 - 11 - 12 - 13 mm
- 1/4" ring ratchet wrench

CODE	DESCRIPTION				PRICE
1-13-907	STANLEY® bit set 1/4" Combination wrench 40-pcs	-	10	3 253561139079	

STANLEY® BIT SET 1/4" - RATCHET WRENCH 32 PCS



- 1/4" bits:
Slot: 4 - 5.5 - 6.5 - 8 mm
PH1 - PH2 - PH3
PZ1 - PZ2 - PZ3
Torx: T8 - T10 - T15 - T20 - T25 - T27 - T30 - T40
Resistorx: T10 - T15 - T20 - T25 - T27 - T30 - T40
: 3 - 4 - 5 - 6mm
- Magnetic bit holder lock-ring 60 mm
- 1/4" ratchet wrench

CODE	DESCRIPTION				PRICE
1-13-904*	STANLEY® bit set 1/4" Ratchet wrench 32 pcs	-	10		

*Not in the Nordic assortment - special order required. Minimum order quantity applied.

STANLEY® BIT SET 1/4" - RATCHET WRENCH, BIT HOLDER - 32 PCS



- 1/4" bits
Slot: 4 - 5.5 - 6.5 - 8 mm
PH1 - PH2 - PH3
PZ1 - PZ2 - PZ3
Torx: T8 - T10 - T15 - T20 - T25 - T27 - T30 - T40
Resistorx: T10 - T15 - T20 - T25 - T27 - T30 - T40
: 3 - 4 - 5 - 6mm
- Magnetic bit holder 60 mm
- 1/4" ring ratchet wrench

CODE	DESCRIPTION				PRICE
1-13-905	STANLEY® bit set 1/4" Combination wrench 32-pcs	-	10		

STANLEY® BIT SET 1/4" - BIT HOLDER - 31 PCS



- 1/4" bits:
Slot: 4 - 4.5 - 5.5 mm
PH1 - PH2 - PH3
PZ1 - PZ2 - PZ3
Torx: T10 - T15 - 2 x T20 - 2 x T25 - 2 x T27 - 2 x T30 - 2 x T40
Resistorx: T10 - T15 - T20 - T25 - T30
: 3 - 4 - 5 - 6mm
- Magnetic bit holder lock-ring 60 mm

CODE	DESCRIPTION				PRICE
1-13-903	STANLEY® bit set 1/4" Bit holder 31-pcs	-	6		

STANLEY® BIT SET 1/4" - BIT HOLDER - 19 PCS



- 1/4" bits:
Slot: 4.5 - 5.5 - 6.5 mm
PH1 - PH2
PZ1 - PZ2 - PZ3 - PZ4
Torx: 10 - 15 - 20 - 25 - 30 - 40
Hex: 3 - 4 - 5 mm
- Magnetic bit holder 60 mm

CODE	DESCRIPTION				PRICE
1-13-901	STANLEY® bit set 1/4" Bit holder 19-pcs	-	6		

STANLEY® PHILLIPS® 1/4" INSERT BIT



- Suitable for industry, construction and DIY

CODE	DESCRIPTION				PRICE
1-68-942*	1/4" Bits Phillips No1 x 25 mm 25 pcs	-	48		
0-68-946*	1/4" Bits Phillips No2 x 25 mm 3 pcs	X	1		
1-68-946*	1/4" Bits Phillips No2 x 25 mm 25 pcs	-	48		
3-68-946*	1/4" Bits Phillips No2 x 25 mm 100 pcs	-	10		
1-68-947*	1/4" Bits Phillips No2 x 50 mm 10 pcs	-	48		
1-68-950*	1/4" Bits Phillips Nr3 x 25 mm 25 pcs	-	48		

*Not in the Nordic assortment - special order required. Minimum order quantity applied.

STANLEY® INSERT BIT POZIDRIV 1/4"



- Suitable for industry, construction and DIY

CODE	DESCRIPTION				PRICE
1-68-945*	1/4" Bits Pozidriv Nr1 x 25 mm 25 pcs	-	1		

*Not in the Nordic assortment - special order required. Minimum order quantity applied.

STANLEY® INSERT BIT TORX® 1/4"



- Suitable for industry, construction and DIY

CODE	DESCRIPTION				PRICE
0-68-842*	1/4" Bits Torx T20 x 25 mm - 3 pcs	X	1		
1-68-842*	1/4" Bits Torx T20 x 25 mm - 25 pcs	-	1		
1-68-843*	1/4" Bits Torx T25 x 25 mm - 25 pcs	-	1		
1-68-845*	1/4" Bits Torx T30 x 25 mm - 25 pcs	-	1		

*Not in the Nordic assortment - special order required. Minimum order quantity applied.

STANLEY® MAGNETIC BIT HOLDER



- 1/4" Hex
- Magnetic cavity holds 1/4 bits securely

CODE	DESCRIPTION				PRICE
0-68-732	1/4" Magnetic Bit Holder 60 mm - 1 pcs	X	1		
1-68-732*	1/4" Magnetic Bit Holder 60 mm - 5 pcs	-	1		
3-68-729*	1/4" Magnetic Bit Holder 75 mm - 5 pcs	-	10		

*Not in the Nordic assortment - special order required. Minimum order quantity applied.

STANLEY® 6-WAY SCREWDRIVER



- All in one screwdriver
- Attach wrench to bolster nut for additional leverage and torque
- Available in an attractive 24 piece merchandiser
- Bar is chrome plated for rust resistance
- Built in bolster allows additional leverage
- High quality bits for long life
- Slip resistant rubber grip provides comfort
- Soft, diamond textured handle provides a firm grip for extra torque without strain
- Tri lobular handle, bimaterial handle for torque and comfortable grip

CODE	DESCRIPTION				PRICE
0-68-012	Stanley 6-Way Screwdriver	-	-	3253560680121	

STANLEY® BITS SET - 10 PCS



- 9 bits and bit holder in plastic storage box
- 1-68-724 Phillips n°2 - Pozidriv n°1, n°2, n°3 - Torx T10, T15, T20, T25, T30
- 1-68-734 Parallel 4.5 x 0.6 mm, 5.5 x 1.0 mm, 6.5 x 1.2 mm - Phillips n°1, n°2, n°3 - Pozidriv n°1, n°2, n°3

CODE	DESCRIPTION				PRICE
1-68-724*	Bits set - 10 pcs	X	20	3 2535614687242	
1-68-734*	Bits set - 10 pcs	X	20	3 2535614687341	

*Not in the Nordic assortment - special order required. Minimum order quantity applied.

STANLEY® BITS SET - 7 PCS

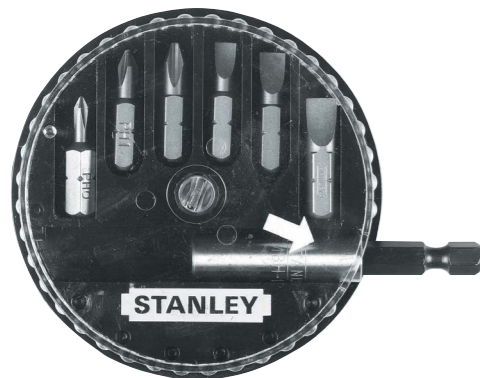

- 6 bits and bit holder (60 mm) in plastic storage box
- 0-68-735 Parallel 0.6 x 4.5 mm, 1.0 x 5.5 mm, 1.2 x 6.5 mm - Phillips n°0, 1, 2 - Magnetic bit holder
- 0-68-737 Parallel 0.8 x 5.0 mm, 1.2 x 6.5 mm - Phillips n°0, 1, 2 - Pozidriv n°1, 2 - Magnetic bit holder
- 0-68-738 Parallel 0.6 x 4.5 mm, 1.0 x 5.5 mm, 1.2 x 6.5 mm - Pozidriv n°0, 1, 2 - Magnetic bit holder
- 0-68-739 T10, T15, T20, T25, T30, T40 - Magnetic Bit Holder

CODE	DESCRIPTION				PRICE
1-68-735*	Bits set 7 pcs	X	24	3 2535614687358	
1-68-737*	Bits set 7 pcs	X	24	3 2535614687372	
1-68-738*	Bits set 7 pcs	X	24	3 2535614687389	
1-68-739*	Bits set 7 pcs	X	24	3 2535614687396	

*Not in the Nordic assortment - special order required. Minimum order quantity applied.

HAND DRILLS

STANLEY® 4 JAW CHUCK RATCHET



- 12-Point, 3 way ratchet for use in confined spaces
- Ball bearing mounting head for smooth operation
- Chromomium plated for corrosion resistance and therefore longer life
- Universal chuck with 4 jaws: diameter 13 mm with holder for square tip bits

CODE	DESCRIPTION				PRICE
1-02-715	4 Jaw Chuck Ratchet 250 mm	-	6	3 2535614027154	

STANLEY® SINGLE PINION HAND DRILL 105



- Aluminium gear wheel both long lasting, strong and lightweight
- Precision die cast for strength and durability
- Mandrel with three 8-mm diameter bits, without key, for wicks with square shank

CODE	DESCRIPTION				PRICE
0-03-105	Single Pinion Hand Drill 105 265 mm	X	6	3 253561031053	

T-HANDLES, P-HANDLES & HEX KEYS

STANLEY® FATMAX® RATCHETING T-HANDLE SET - 27 PCS

STANLEY
FATMAX



- Ratcheting Mechanism – Industry first for T-Handle. This speeds up the application as you can keep the key in the fastener while returning tool to the starting position
- 27-pcs set supplied with:
 - St: 3 × 35 mm, 4-5 × 35 mm, 6-8 × 51 mm, 4-5 × 150 mm, 6-8 × 150 mm
 - PZ: PZ1 × 35 mm, PZ2 × 35mm (2), PZ3 × 35mm, PZ1 × 150mm, PZ2 × 150mm (2), PZ3 × 150mm
 - PH: PH1 × 35mm, PH2 × 35mm, PH3 × 35mm
 - Torx: T15 × 150mm, T20 × 150mm, T25 × 150mm
 - Hex: 2.5 × 116mm, 3 × 116mm, 4 × 164mm, 5 × 164mm, 6 × 164mm, 8 × 164mm

CODE	DESCRIPTION				PRICE
0-79-153	FATMAX® Ratcheting T-Handle Set - 27 pcs	-	4	3 253560 791537	

HEX KEY METRIC SET METRIC - 9 PCS



- Additional multi position handle for use in line or as a T or L handle for improved comfort and to generate more leverage
- All keys stored in a size marked plastic holder for easy selection
- Ball hex configuration on the long arm to allow offset driving of hard to reach set screws
- Black anti-corrosion galvanised finish
- Can be used at an angle of up to 25°
- Straight hex on short arm for maximum leverage
- High-resistance chrome vanadium steel
- 1.5, 2, 2.5, 3, 4, 5, 6, 8, 10mm

CODE	DESCRIPTION				PRICE
0-89-904	Hex Key Metric Set Metric - 9 pcs	X	6	3 253560 899042	

HEX KEY SET - 8 PCS

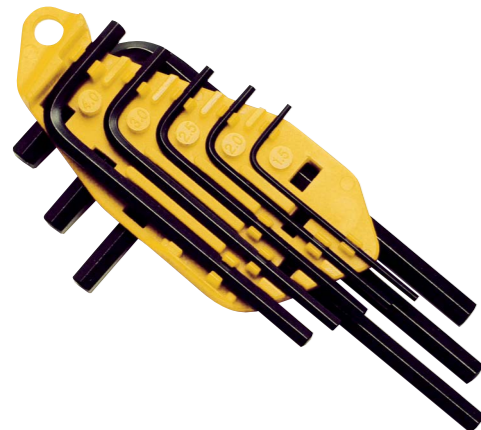

- Standard hex keys in high tensile steel for long life
- Material: steel
- 0-69-251: 1.5, 2, 2.5, 3, 4, 5, 5.5, 6mm
- 0-69-252: 1/16" - 1/4"
- 0-69-253: 1.5, 2, 2.5, 3, 4, 5, 5.5, 6, 8, 10mm

CODE	DESCRIPTION				PRICE
0-69-251	Hex key set 8 pcs 1.5 mm-6 mm	X	24	3 253560 692513	
0-69-252	Hex key set - 1/16 - 1/4"	X	24	3253560692520	
0-69-253	Hex key set 10 pcs 1.5-10 mm	X	24	3 253560 692537	

BALL HEX KEY SET - 9 PCS



- All keys are marked per as their size for easy selection
- Standard hex keys in high tensile steel for long life
- Long arm, ball point hex keys, allows engagement in angles of up to 25°
- 1.5, 2, 2.5, 3, 4, 5, 6, 8, 10mm

CODE	DESCRIPTION				PRICE
0-69-256	Ball Hex Key Set 9 PCS. - 5-10 mm	X	24	3 253560 692568	

STANLEY® FATMAX® LOCKING HEX-KEY METRIC SET

STANLEY
FATMAX



- Convenient "Button Lock" releases Hex Keys for secure and easy change from moving to locked
- Ergonomic handle for better grip allowing application of more torque
- Extra long keys give easy access for recessed bolts
- 0-97-552 : 1.5, 2, 2.5, 3, 4, 5, 6, 8mm
- 0-97-553: T9, T10, T15, T20 (x2), T25, T27, T30

CODE	DESCRIPTION				PRICE
0-97-552	FATMAX® Locking Hex-Key Metric Set (mm)	X	12	3 253560 975524	
0-97-553	FATMAX® Locking Hex-Key Metric Set (Torx)	X	12	3 253560 975531	

FOLDING KEY SET - 7 PCS



- 7 pcs metric flat head screwdrivers in high tensile steel
- 4-69-261: 1.5, 2, 2.5, 3, 4, 5, 6mm
- 4-69-262: 2.5, 3, 4, 5, 6, 8, 10mm

CODE	DESCRIPTION				PRICE
4-69-262	Folding key set 7 pcs 2.5-10 mm	X	12	3 253564 692625	
4-69-261	Folding key set 7 pcs 1.5-6 mm	X	12	3 253564 692618	

FOLDING TORX SET - 8 PCS



- Set of 8 keys with Torx®
- Made of high tensile steel
- T9, T10, T15, T20, T25, T27, T30, T40

CODE	DESCRIPTION				PRICE
4-69-263*	Folding Torx set - T9-T40	X	12	3 2 5 3 5 6 4 1 6 9 2 6 3 2	

FOLDING KEY SETS - 8 PCS



- Comfortable over molded ergonomic handle
- All keys stored in a size marked order for ease of access & identification
- Black phosphate finish
- 2-69-264: 1.5 - 2 - 2.5 - 3 - 4 - 5 - 6 - 8mm
- 2-69-266: T9, T10, T15, T20, T25, T27, T30, T40

CODE	DESCRIPTION				PRICE
2-69-264	Folding hex key set - 8 pcs	X	12	3 2 5 3 5 6 2 1 6 9 2 6 4 1	
2-69-266	Folding Torx set - 8 pcs	X	12	3 2 5 3 5 6 2 1 6 9 2 6 6 5	

TRIANGLE FOLDER HEX KEY SET



- Hex keys fold out for easy access and storage
- High impact & ergonomic case for improved comfort
- Once the hex key is locked into place the storage unit becomes the driver handle
- Rubber grip for outstanding comfort

CODE	DESCRIPTION				PRICE
0-95-935	STANLEY® 9 Piece Triangle Folder Hex Key Set metric	X	12	3253560959357	

STANLEY® FATMAX® P-HANDLE HEX KEY SET - 6 PCS



- Black oxidised coating for corrosion resistance
- Ergonomic P-handle for comfort
- Ideal for fastening hex screws
- 3,4,5,6,7,8 mm

CODE	DESCRIPTION				PRICE
FMHT0-69049	STANLEY® FATMAX® P-Handle Hex Key Set - 6 pcs	X		3253560690496	

STANLEY® FATMAX® P-HANDLE HEX KEY SET - 5 PCS



- Black oxidised coating for corrosion resistance
- Ergonomic P-handle for comfort
- Ideal for fastening hex screws
- T10 - T15 - T20 - T25 - T30

CODE	DESCRIPTION				PRICE
FMHT0-69048	STANLEY® FATMAX® P-Handle Hex Key Set 5 pcs	X	12	3253560690489	

THE MEASURE OF A PRO™



MECHANICAL TOOLS

The STANLEY® offering of mechanical tools supplies both do-it-yourselfers and pros with a wide range of product options to successfully accomplish the job at hand. STANLEY® mechanical tools are made to the same professional standards as the tools you use on the job every day.

Turn to STANLEY® for ratcheting, flare nut, and combination open/box-end wrench sets in standard SAE and metric sizes in either polish or black chrome finish. Or take a STANLEY® single adjustable, ratcheting, pipe wrench for a spin.

REVERSIBLE RATCHETING WRENCH SETS

FATMAX® REVERSIBLE RATCHETING WRENCH SETS

STANLEY
FATMAX



- Anti-slip design provides improved bolt contact
- 72-tooth ratchet with a one pawl mechanism, with 5° increment/arc swing for improved access - 15° offset
- 12-point reversible ratcheting box end
- Forged in corrosion-resistant chrome vanadium steel with a satin chrome finish and an anti-slip profile
- 7-part: 8 - 10 - 12 - 13 - 14 - 17 - 19 mm
- 12 pieces: 8 - 9 - 10 - 11 - 12 - 13 - 14 - 15 - 16 - 17 - 18 - 19 mm

CODE	DESCRIPTION				PRICE
FMMT82848-0	FATMAX Combination wrench set with ratcheting box end 7 pcs	X	10	3	25356011828486
FMMT82849-0	FATMAX Combination wrench set with ratcheting box end 12 pcs	X	10	3	25356011828493

REVERSIBLE RATCHETING WRENCH SETS



- Anti-slip design provides improved bolt contact
- 72-tooth ratchet with a one pawl mechanism, with 5° increment/arc swing for improved access - 15° offset
- 12-point reversible ratcheting box end
- Forged in corrosion-resistant chrome vanadium steel - chrome finish
- 7-part: 8 - 10 - 12 - 13 - 14 - 17 - 19 mm
- 12 pieces: 8 - 9 - 10 - 11 - 12 - 13 - 14 - 15 - 16 - 17 - 18 - 19 mm

CODE	DESCRIPTION				PRICE
STMT82846-0	Reversible Ratcheting Wrench Set - 7 pieces	X	8	3	25356011828462
STMT82847-0	Reversible Ratcheting Wrench Set - 12 pcs	X	4	3	25356011828479

FATMAX® REVERSIBLE RATCHETING WRENCH SET - STUBBY

STANLEY
FATMAX



- Anti-slip design provides improved bolt contact
- 72-tooth ratchet with a one pawl mechanism, with 5° increment/arc swing for improved access - 15° offset
- 12-point reversible ratcheting box end - 15° offset
- Forged in corrosion-resistant chrome vanadium steel with a satin chrome finish and an anti-slip profile
- Content: 8 - 10 - 12 - 13 - 14 - 17 - 19mm

CODE	DESCRIPTION				PRICE
FMMT82900-0	FATMAX Reversible Ratcheting Wrench Set - STUBBY 7 pcs	X	16	3	25356011829001

FATMAX® REVERSIBLE RATCHETING WRENCH SET

STANLEY
FATMAX



- Anti-slip design provides improved bolt contact
- 12-point reversible ratcheting box end - 15° offset
- Forged in corrosion-resistant chrome vanadium steel with a satin chrome finish and an anti-slip profile
- 7 pcs: 8 - 10 - 12 - 13 - 14 - 17 - 19 mm
- 12 pcs: 8 - 9 - 10 - 11 - 12 - 13 - 14 - 15 - 16 - 17 - 18 - 19 mm

CODE	DESCRIPTION				PRICE
FMMT82844-0	FATMAX Combination wrench set 7 pieces	X	10	3	25356011828448
FMMT82845-0	FATMAX Combination spanner set 12 pcs	X	10	3	25356011828455

COMBINATION WRENCH SET



- Anti-slip design provides improved bolt contact
- 12-point reversible ratcheting box end - 15° offset
- Forged in corrosion-resistant chrome vanadium steel - chrome finish
- 7 pcs: 8 - 10 - 12 - 13 - 14 - 17 - 19 mm
- 12 pcs: 8 - 9 - 10 - 11 - 12 - 13 - 14 - 15 - 16 - 17 - 18 - 19 mm

CODE	DESCRIPTION				PRICE
STMT82842-0	Combination Wrench Set - 7 pcs	X	8	3	25356011828424
STMT82843-0	Combination Wrench Set - 12 pcs	X	4	3	25356011828431

COMBINATION WRENCHES - ESSENTIAL

- 12-point versatile box end - for easy fitting over nuts and bolts finish
- 15° offset open and box end - bringing improved access



CODE	DESCRIPTION				PRICE
STMT95908-0	Combination Wrench 8 mm	X	8		3253560959081
STMT95787-0	Combination Wrench 9 mm	X	8		3253560957872
STMT95788-0	Combination Wrench 10 mm	X	8		3253560957889
STMT95789-0	Combination Wrench 11 mm	X	8		3253560957896
STMT95790-0	Combination Wrench 12 mm	X	8		3253560957902
STMT95791-0	Combination Wrench 13 mm	X	8		3253560957919
STMT95792-0	Combination Wrench 14 mm	X	8		3253560957926
STMT95909-0	Combination Wrench 15 mm	X	8		3253560959098
STMT95910-0	Combination Wrench 16 mm	X	8		3253560959104
STMT95793-0	Combination Wrench 17 mm	X	8		3253560957933
STMT95911-0	Combination Wrench 18 mm	X	8		3253560959111
STMT95912-0	Combination Wrench 19 mm	X	8		3253560959128

FATMAX® ANTI-SLIP REVERSIBLE RATCHETING WRENCHS

STANLEY
FATMAX

CHROME VANADIUM STEEL
forged in corrosion resistant chrome vanadium steel with a satin chrome finish and an anti-slip profile

ANTI-SLIP DESIGN
Providing improved bolt contact, preventing slipping

72T RATCHET MECHANISM
Allowing for 5° increments, ensuring tightening capacity and accuracy within narrow spaces

15° OFFSET OPEN AND BOX END
Bringing improved access

SWITCH LEVER
Allowing for easy, one-handed operation

12-POINT VERSATILE BOX END
For easy fitting over nuts and bolts



CODE	DESCRIPTION				PRICE
FMMT13081-0*	FATMAX Anti-slip reversible ratcheting wrench 8 mm	X	10		
FMMT13082-0*	FATMAX Anti-slip reversible ratcheting wrench 9 mm	X	10		
FMMT13083-0*	FATMAX Anti-slip reversible ratcheting wrench 10 mm	X	10		
FMMT13084-0*	FATMAX Anti-slip reversible ratcheting wrench 11 mm	X	10		
FMMT13085-0*	FATMAX Anti-slip reversible ratcheting wrench 12 mm	X	10		
FMMT13086-0*	FATMAX Anti-slip reversible ratcheting wrench 13 mm	X	10		
FMMT13087-0*	FATMAX Anti-slip reversible ratcheting wrench 14 mm	X	10		
FMMT13088-0*	FATMAX Anti-slip reversible ratcheting wrench 15 mm	X	10		
FMMT13089-0*	FATMAX Anti-slip reversible ratcheting wrench 16 mm	X	10		
FMMT13094-0*	FATMAX Anti-slip reversible ratcheting wrench 17 mm	X	10		
FMMT13095-0*	FATMAX Anti-slip reversible ratcheting wrench 18 mm	X	10		
FMMT13096-0*	FATMAX Anti-slip reversible ratcheting wrench 19 mm	X	10		

*Not in the Nordic assortment - special order required. Minimum order quantity applied.



FATMAX® ANTI-SLIP STUBBY RATCHETING WRENCH

STANLEY
FATMAX

- Anti-slip design provides improved bolt contact
- 72-tooth ratchet with a one pawl mechanism, with 5° increment/arc swing
- 12-point reversible ratcheting box end - 15° angle offset
- Open-ended wrench in 15° angle - optimum accessibility
- Made of chrome vanadium steel with matt chrome finish

CODE	DESCRIPTION				PRICE
FMMT13097-0*	FATMAX Anti-slip stubby ratcheting wrench 8 mm	X	10		
FMMT13098-0*	FATMAX Anti-slip stubby ratcheting wrench 10 mm	X	10		
FMMT13109-0*	FATMAX Anti-slip stubby ratcheting wrench 12 mm	X	10		
FMMT13111-0*	FATMAX Anti-slip stubby ratcheting wrench 13 mm	X	10		
FMMT13112-0*	FATMAX Anti-slip stubby ratcheting wrench 14 mm	X	10		
FMMT13113-0*	FATMAX Anti-slip stubby ratcheting wrench 17 mm	X	10		
FMMT13115-0*	FATMAX Anti-slip stubby ratcheting wrench 19 mm	X	10		

*Not in the Nordic assortment - special order required. Minimum order quantity applied.



FATMAX® ANTI-SLIP COMBINATION WRENCH

STANLEY
FATMAX

- Non-slip design - providing improved bolt contact, preventing slipping
- 12-point versatile box end
- 15° offset
- Made of chrome vanadium steel with matt chrome finish

CODE	DESCRIPTION				PRICE
FMMT13029-0*	FATMAX Combination wrench 6 mm Anti-slip	X	10		
FMMT13030-0*	FATMAX Combination wrench 7 mm Anti-slip	X	10		
FMMT13031-0*	FATMAX Combination wrench 8 mm Anti-slip	X	10		
FMMT13032-0*	FATMAX Combination wrench 9 mm Anti-slip	X	10		
FMMT13033-0*	FATMAX Combination wrench 10 mm Anti-slip	X	10		
FMMT13034-0*	FATMAX Combination wrench 11 mm Anti-slip	X	10		
FMMT13035-0*	FATMAX Combination wrench 12 mm Anti-slip	X	10		
FMMT13036-0*	FATMAX Combination wrench 13 mm Anti-slip	X	10		
FMMT13037-0*	FATMAX Combination wrench 14 mm Anti-slip	X	10		
FMMT13038-0*	FATMAX Combination wrench 15 mm Anti-slip	X	10		
FMMT13039-0*	FATMAX Combination wrench 16 mm Anti-slip	X	10		
FMMT13040-0*	FATMAX Combination wrench 17 mm Anti-slip	X	10		
FMMT13041-0*	FATMAX Combination wrench 18 mm Anti-slip	X	10		
FMMT13042-0*	FATMAX Combination wrench 19 mm Anti-slip	X	10		

*Not in the Nordic assortment - special order required. Minimum order quantity applied.



OPEN END WRENCH SETS

FATMAX® OPEN END WRENCH SETS

STANLEY
FATMAX



- Anti-slip design provides improved bolt contact
- Double wrench - 2 sizes for one wrench
- 15° offset
- Forged in corrosion-resistant chrome vanadium steel with a satin chrome finish and an anti-slip profile
- 7 pcs: 6×7, 8×9, 10×11, 12×13, 14×15, 16×17, 18×19mm
- 12 pcs : 6×7, 8×9, 10×11, 12×13, 14×15, 16×17, 18×19, 20×22, 21×23, 24×26, 25×28, 30× 32mm

CODE	DESCRIPTION				PRICE
FMMT82901-0	FATMAX Open End Wrench set 7 pcs	X	2		
FMMT82902-0	FATMAX Open End Wrench set 12 pcs	X	6		

FATMAX® ANTI-SLIP OPEN-END WRENCH

STANLEY
FATMAX



- Anti-slip design provides improved bolt contact
- Double wrench - 2 sizes for one wrench
- 15° offset
- Made of chrome vanadium steel with matt chrome finish

CODE	DESCRIPTION				PRICE
FMMT13062-0*	FATMAX Anti-slip open-end wrench 6 × 7 mm	X	10		
FMMT13065-0	FATMAX Anti-slip open-end wrench 8 × 9 mm	X	10		
FMMT13066-0	FATMAX Anti-slip open-end wrench 10 × 11 mm	X	10		
FMMT13067-0	FATMAX Anti-slip open-end wrench 12 × 13 mm	X	10		
FMMT13068-0*	FATMAX Anti-slip open-end wrench 14 × 15 mm	X	10		
FMMT13069-0*	FATMAX Anti-slip open-end wrench 16 × 17 mm	X	10		
FMMT13070-0*	FATMAX Anti-slip open-end wrench 18 × 19 mm	X	10		
FMMT13071-0*	FATMAX Anti-slip open-end wrench 20 × 22 mm	X	10		
FMMT13072-0*	FATMAX Anti-slip open-end wrench 21 × 23 mm	X	4		
FMMT13073-0*	FATMAX Anti-slip open-end wrench 24 × 27 mm	X	4		
FMMT13074-0*	FATMAX Anti-slip open-end wrench 25 × 28 mm	X	4		
FMMT13077-0*	FATMAX Anti-slip open-end wrench 30 × 32 mm	X	4		

*Not in the Nordic assortment - special order required. Minimum order quantity applied.

ADJUSTABLE WRENCHES

FATMAX® QUICK ADJUSTABLE WRENCH BI-MATERIAL

STANLEY
FATMAX



QUICK ADJUSTMENT MECHANISM
Bringing fast and accurate settings

CODE	DESCRIPTION				PRICE
FMHT13125-0	FATMAX Adjustable wrench bimat 150 × 24 mm	X	2		
FMHT13126-0	FATMAX Adjustable wrench bimat 200 × 29 mm	X	2		
FMHT13127-0	FATMAX Adjustable wrench bimat 250 × 33 mm	X	2		
FMHT13128-0	FATMAX Adjustable wrench bimat 300 × 38 mm	X	2		

ADJUSTABLE WRENCH METAL



- Parallel jaws placed at a 15° angle provide a firm grip and best reach
- Metric/Inch scale - maximizing the tightening applications

CODE	DESCRIPTION				PRICE
STHT13121-0	Adjustable wrench 150 × 19 mm	X	2		
STHT13122-0	Adjustable wrench 200 × 24 mm	X	2		
STHT13123-0	Adjustable wrench 250 × 29 mm	X	2		
STHT13156-0	Adjustable wrench 300 × 36 mm	X	2		

ADJUSTABLE WRENCH BI-MATERIAL

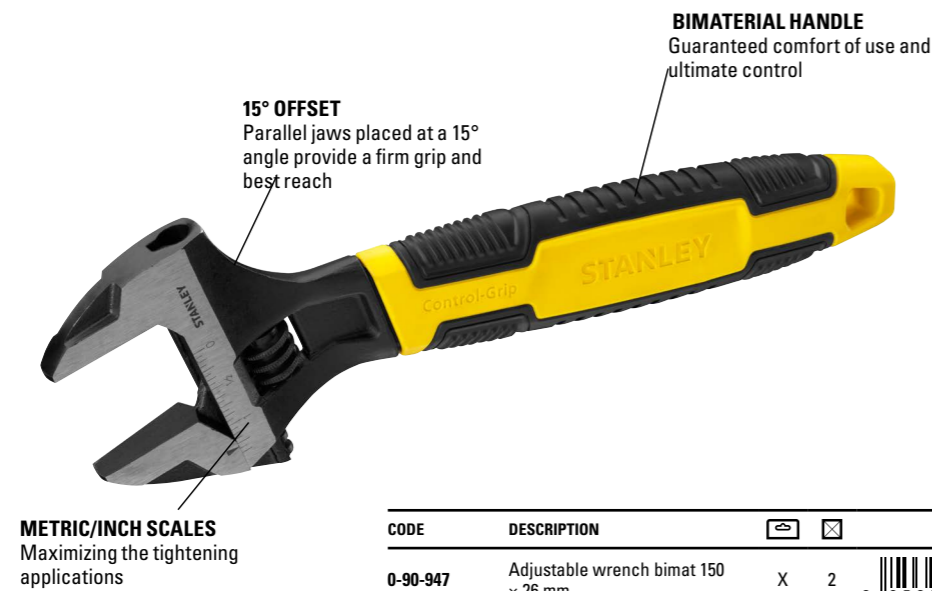

CODE	DESCRIPTION	☐	☒	☐	PRICE
0-90-947	Adjustable wrench bimat 150 × 26 mm	X	2	3	2 5 3 5 6 0 1 9 0 9 4 7 5
0-90-948	Adjustable wrench bimat 200 × 31 mm	X	2	3	2 5 3 5 6 0 1 9 0 9 4 8 2
0-90-949	Adjustable wrench bimat 250 × 36 mm	X	2	3	2 5 3 5 6 0 1 9 0 9 4 9 9
0-90-950	Adjustable wrench bimat 300 × 40 mm	X	2	3	2 5 3 5 6 0 1 9 0 9 5 0 5

FATMAX® ADJUSTABLE WRENCH

STANLEY
FATMAX

- Chrome vanadium steel
- Ergonomic handle
- Rust resistant chrome finish



CODE	DESCRIPTION	☐	☒	☐	PRICE
0-95-872*	FATMAX Adjustable Wrench 150 × 26 mm	X	4	3	2 5 3 5 6 0 1 9 5 8 7 2 5
0-95-873*	FATMAX Adjustable Wrench 200 × 31 mm	X	4	3	2 5 3 5 6 0 1 9 5 8 7 3 2
0-95-874*	FATMAX Adjustable Wrench 250 × 37 mm	X	4	3	2 5 3 5 6 0 1 9 5 8 7 4 9
0-84-540*	FATMAX Adjustable Wrench 300 × 43 mm	X	4	3	2 5 3 5 6 0 1 8 4 5 4 0 7
0-95-876*	FATMAX Adjustable Wrench 375 × 48 mm	X	4	3	2 5 3 5 6 0 1 9 5 8 7 6 3

*Not in the Nordic assortment - special order required. Minimum order quantity applied.

SELF-TIGHTENING RATCHETING WRENCH



- No need to remove from fastener while tightening or loosening
- Easy to enlarge all sizes of fastening within size range
- Generously sized bi-material handle for enhanced comfort and performance

CODE	DESCRIPTION	☐	☒	☐	PRICE
4-87-988*	Self-tightening ratcheting wrench 8 - 14 mm	X	10	3	2 5 3 5 6 4 1 8 7 9 8 8 0
4-87-989*	Self-tightening ratcheting wrench 13 - 19 mm	X	10	3	2 5 3 5 6 4 1 8 7 9 8 9 7
4-87-990*	Self-tightening ratcheting wrench 17 - 24 mm	X	10	3	2 5 3 5 6 4 1 8 7 9 9 0 3

*Not in the Nordic assortment - special order required. Minimum order quantity applied.

RATCHETS

FATMAX® RATCHET 120T

STANLEY
FATMAX



- 120 tooth ratchet - with dual pawl mechanism for 2X better access in tight spaces vs. traditional 60T ratchet
- Low profile switch lever - prevents accidental switching and allows for easy, one-handed operation
- Quick release mechanism to release sockets quickly
- Bi-material handle for comfort, better grip and control

CODE	DESCRIPTION	☐	☒	☐	PRICE
FMMT82676-0	FATMAX ratchet 1/4" 120T	X	4	3	2 5 3 5 6 0 1 8 2 6 7 6 5
FMMT82677-0	FATMAX ratchet 3/8" 120T	X	4	3	2 5 3 5 6 0 1 8 2 6 7 7 2
FMMT82678-0	FATMAX ratchet 1/2" 120T	X	8	3	2 5 3 5 6 0 1 8 2 6 7 8 9

RATCHET 72T



- 72 tooth ratchet - fine tothing provides 5° increment
- Low profile switch lever - prevents accidental switching and allows for easy, one-handed operation
- Quick release mechanism to release caps quickly
- Bi-material handle for comfort, better grip and control

CODE	DESCRIPTION	☐	☒	☐	PRICE
STMT82663-0	Ratchet 1/4" 72T	X	12	3	2 5 3 5 6 0 1 8 2 6 6 3 5
STMT82664-0	Ratchet 3/8" 72T	X	12	3	2 5 3 5 6 0 1 8 2 6 6 4 2
STMT82665-0	Ratchet 1/2" 72T	X	8	3	2 5 3 5 6 0 1 8 2 6 6 5 9

FATMAX® RATCHET SET 1/4" 120T

STANLEY
FATMAX



- 120 tooth ratchet - with dual pawl mechanism for 2X better access in tight spaces vs. traditional 60T ratchet
- Low reversing lever - prevents accidental movement and allows one-handed operation
- Quick release mechanism to release caps quickly
- Bi-material handle for comfort, better grip and control
- Content:
Ratchet 1/4" 120T
Sockets 1/4" (12-point): 5.5 - 6 - 7 - 8 - 9 - 10 - 11 - 12 - 13 - 14 mm
Bit holder 1/4"
Bits 1/4": PH0 - PH1 - PH2 - Slot 3.5 - 4.5 - 8 - Torx 15 - 20 - 25 - 30

CODE	DESCRIPTION	☐	☒	☐	PRICE
FMMT82679-0	FATMAX Ratchet Set 1/4" 120T	X	8	3	2 5 3 5 6 0 1 8 2 6 7 9 6

RATCHET SET 1/4" 72T 11 PCS



- 72 tooth ratchet - fine toothing provides 5° increment
- Bi-material handle for comfort, better grip and control
- Caps with 12 side
- Content:
Ratchet 1/4" 72T
Sockets 1/4" (12 side): 5.5 - 6 - 7 - 8 - 9 - 10 - 11 - 12 - 13 - 14 mm

CODE	DESCRIPTION				PRICE
STMT82666-0	Ratchet set 1/4" 72T 11 pcs	X	8		

FATMAX® RATCHET SET 3/8" 120T

STANLEY
FATMAX



- 120 tooth ratchet - with dual pawl mechanism for 2X better access in tight spaces vs. traditional 60T ratchet
- Low reversing lever - prevents accidental movement and allows one-handed operation
- Quick release mechanism to release caps quickly
- Bi-material handle for comfort, better grip and control
- Content:
Ratchet 3/8" 120T
Sockets 1/4" (12-point): 8 - 9 - 10 - 11 - 12 - 13 - 14 - 15 - 16 - 17 mm
Bit holder 3/8" for 1/4" bits
Bits 1/4": PH0 - PH1 - PH2 - Slot 3.5 - 4.5 - 8 - Torx 15 - 20 - 25 - 30

CODE	DESCRIPTION				PRICE
FMMT82680-0	FATMAX Ratchet Set 3/8" 120T	X	2		

RATCHET SET 3/8" 72T 11 PCS



- 72 tooth ratchet - fine toothing provides 5° increment
- Bi-material handle for comfort, better grip and control
- 12-points profile - on rail to hold sockets
- Content:
Ratchet 3/8" 72T
Sockets 3/8" (12-point): 8 - 9 - 10 - 11 - 12 - 13 - 14 - 15 - 16 - 17 mm

CODE	DESCRIPTION				PRICE
STMT82670-0	Ratchet set 3/8" 72T 11 pcs	X	8		

FATMAX® RATCHET SET 1/2" 120T

STANLEY
FATMAX



- 120 tooth ratchet - with dual pawl mechanism for 2X better access in tight spaces vs. traditional 60T ratchet
- Low reversing lever - prevents accidental movement and allows one-handed operation
- Quick release mechanism to release caps quickly
- Bi-material handle for comfort, better grip and control
- Content:
Ratchet 1/2" 120T
Sockets 1/2" (12-point): 13 - 14 - 15 - 16 - 17 - 18 - 19 - 22 - 24 mm
Bit holder 1/2" for 5/16" bits
Bits 5/16": PH0 - PH1 - PH2 - Slot 3.5 - 4.5 - 8 - Torx 15 - 20 - 25 - 30

CODE	DESCRIPTION				PRICE
FMMT82681-0	FATMAX Ratchet Set 1/2" 120T	X	4		

RATCHET SET 1/2" 72T 10 PCS



- 72 tooth ratchet - fine toothing provides 5° increment
- Bi-material handle for comfort, better grip and control
- 12-points profile - on rail to hold sockets
- Content:
Ratchet 1/2" 72T
Sockets 1/2" (12-point): 13 - 14 - 15 - 16 - 17 - 18 - 19 - 22 - 24 mm

CODE	DESCRIPTION				PRICE
STMT82671-0	Ratchet set 1/2" 72T 10 pcs	X	4		

CHROME ROTATOR RACHET SET - 1/4" & 3/8"



- Normal ratchet -twist handle for quick ratchet
- Easy to use top reverse switch
- Consumer friendly 'Try Me' packaging
- 1/4" Ratchet + 4 mm, 5 mm, 5.5 mm, 6 mm, 7 mm, 8 mm, 9 mm, 10 mm, 11 mm, 13mm sockets set (11 pcs set)
- 3/8" Ratchet + 10 mm, 11 mm, 12 mm, 13 mm, 14 mm, 15 mm, 17 mm, 19mm sockets set (9 pcs set)

CODE	DESCRIPTION				PRICE
0-94-606	Chrome Rotator Ratchet Set 9 pcs	X	4		3253560946067
0-94-607	Chrome Rotator Ratchet Set 11 pcs	X	4		3253560946074

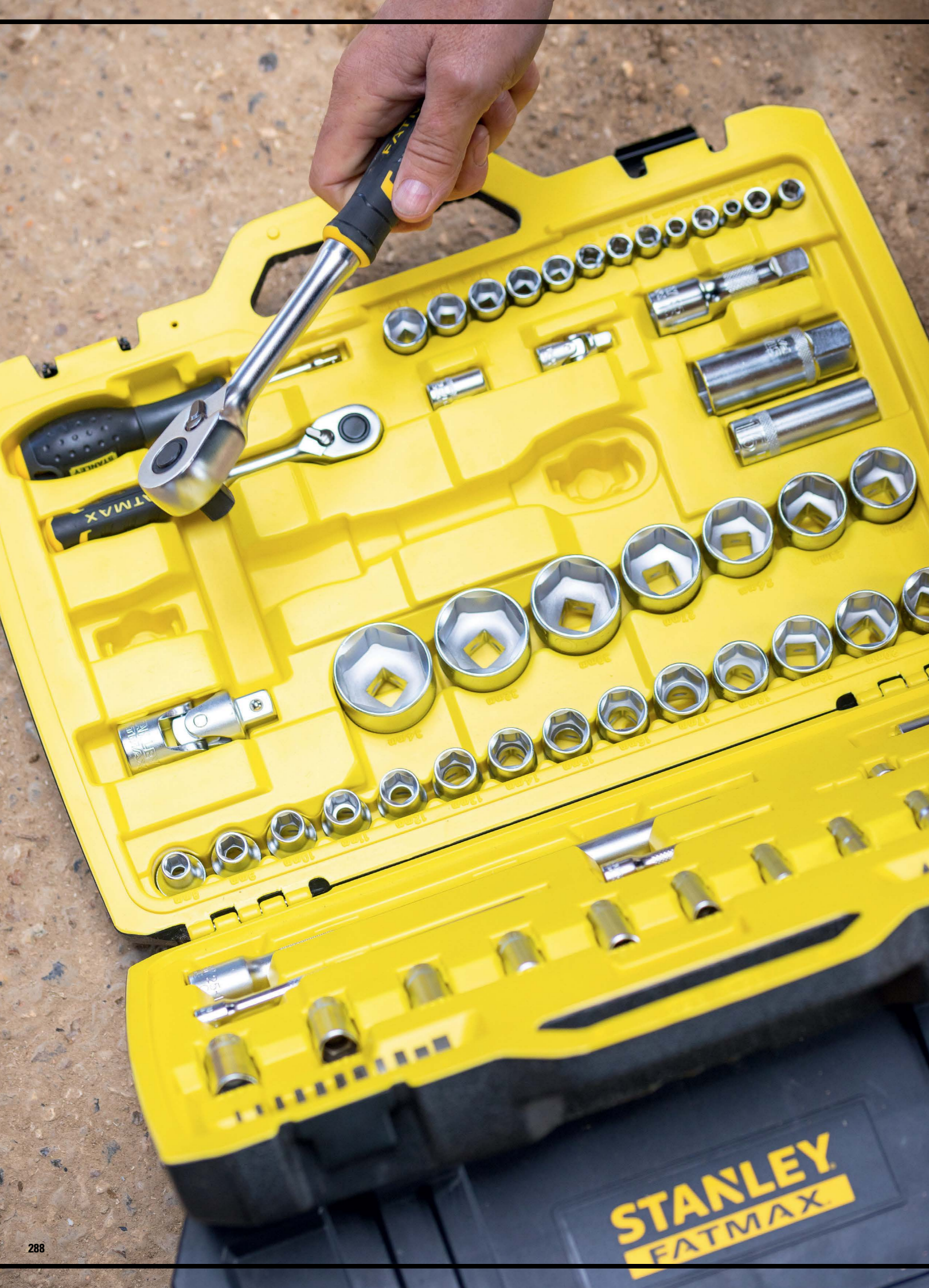

SOCKET SETS 1/4"

FATMAX® SOCKET SET 1/4" 42 PCS

STANLEY
FATMAX



- Content:
- Ratchet 1/4" 120T
- Sockets 1/4" (6-points profile): 4 - 4.5 - 5 - 5.5 - 6 - 7 - 8 - 9 - 10 - 11 - 12 - 13 - 14 mm
- Extensions 1/4": 3" - 6"
- Universal joint 1/4"
- Bit holder 1/4"
- Spinner handle 1/4"
- Sliding T-handle 1/4"
- Bits 1/4": PZ1 - PZ2 - PZ3 - PH1 - PH2 - PH3 - Hex: 3 - 4 - 5 - 6 - 7 - Torx 10 - 15 - 20 - 25 - 27 - 30 - 40 - Slot: 4 - 5 - 6 - 7

CODE	DESCRIPTION				PRICE
FMMT82683-1	Socket set 1/4" 42 pcs	-	6		

SOCKET SET 1/4" 38 PCS



- Content:
- Ratchet 1/4" 72T
- Sockets 1/4" (6-points profile): 5.5 - 6 - 7 - 8 - 9 - 10 - 11 - 12 - 13 - 14 mm
- Extensions 1/4": 3" - 6"
- Bit holder 1/4"
- Spinner handle 1/4"
- Bits 1/4": PZ1 - PZ2 - PZ3 - PH1 - PH2 - PH3 - Hex 3 - 4 - 5 - 6 - 7 - Torx 10 - 15 - 20 - 25 - 27 - 30 - 40 - Slot 4 - 5 - 6 - 7
- Universal joint 1/4"

CODE	DESCRIPTION				PRICE
STMT82828-1	Socket set 1/4" 38 pcs	-	4		

COMPACT SOCKET SET 1/4" 37 PCS



- Compact box, easy to transport and store
- Content:
- Ratchet 1/4" 72T
- Sockets 1/4" (12-point): 4 - 4.5 - 5 - 6 - 7 - 8 - 9 - 10 - 11 - 12 - 13 - 14 mm
- Extension 1/4": 3"
- Bit holder 1/4"
- Bits 1/4": PZ1 - PZ2 - PZ3 - PH1 - PH2 - PH3 - Hex 3 - 4 - 5 - 6 - 7 - Torx 10 - 15 - 20 - 25 - 27 - 30 - 40 - Slot 4 - 5 - 6 - 7

CODE	DESCRIPTION				PRICE
STMT82672-0	Compact socket set 1/4" 37 pcs	X	5		

SOCKET SETS 3/8"

FATMAX® SOCKET SET 3/8" 49 PCS

STANLEY
FATMAX



- Content:
- Ratchet 3/8" 120T
- Sockets 3/8" (6-points profile): 8 - 9 - 10 - 11 - 12 - 13 - 14 - 15 - 16 - 17 - 18 - 19 - 20 - 21 - 22 - 23 - 24 mm
- Extensions 3/8": 3" - 6"
- Sliding T-handle 3/8"
- Universal joint 3/8"
- Bit holder 3/8" for 1/4" bits
- Spark plug sockets 3/8": 16 - 21 mm
- Spinner handle 1/4"
- Bit holder 1/4"
- Bits 1/4": PZ1 - PZ2 - PZ3 - PH1 - PH2 - PH3 - 6 side 3 - 4 - 5 - 6 - 7 - Torx 10 - 15 - 20 - 25 - 27 - 30 - 40 - Slot 4 - 5 - 6 - 7

CODE	DESCRIPTION				PRICE
FMMT82684-1	FATMAX Socket set 3/8" 49 pcs	-	2		

SOCKET SET 3/8" 45 PCS



- Content:
- Ratchet 3/8" 72T
- Sockets 3/8" (6-points profile): 8 - 10 - 11 - 12 - 13 - 14 - 15 - 16 - 17 - 18 - 19 - 20 - 21 - 22 mm
- Extensions 3/8": 3" - 5"
- Universal joint 3/8"
- Bit holder 3/8" for 1/4" bits
- Spark plug sockets 3/8": 16 - 21 mm
- Spinner handle 1/4"
- Bit holder 1/4"
- Bits 1/4": PZ1 - PZ2 - PZ3 - PH1 - PH2 - PH3 - 6 side 3 - 4 - 5 - 6 - 7 - Torx 10 - 15 - 20 - 25 - 27 - 30 - 40 - Slot 4 - 5 - 6 - 7

CODE	DESCRIPTION				PRICE
STMT82829-1	Socket set 3/8" 45 pcs	-	2		

SOCKET SET 1/2"

FATMAX® SOCKET SET 1/2" 26 PCS

STANLEY
FATMAX



- Content:
- Ratchet 1/2" 120T
- Sockets 1/2" (6-points profile): 8 - 9 - 10 - 11 - 12 - 13 - 14 - 15 - 16 - 17 - 18 - 19 - 20 - 21 - 22 - 23 - 24 - 27 - 30 - 32 - 34 mm
- Extensions 1/2": 3" - 10"
- Sliding T-handle 1/2"
- Universal joint 1/2"

CODE	DESCRIPTION				PRICE
FMMT82685-1	FATMAX socket set 1/2" 26 pcs	-	2		

SOCKET SET 1/2" 24 PIECES



- Content:
- Ratchet 1/2" 72T
- Sockets 1/2" (6-points profile): 8 - 9 - 10 - 11 - 12 - 13 - 14 - 15 - 16 - 17 - 18 - 19 - 20 - 21 - 22 - 23 - 24 - 27 - 30 - 32 mm
- Extensions 1/2": 3"-10"
- Universal joint 1/2"

CODE	DESCRIPTION				PRICE
STMT82830-1	Socket set 1/2" 24 pcs	-	3		

SOCKET SETS MIXED

FATMAX® COMBINATION SET 1/4" + 1/2" 49 PCS

STANLEY
FATMAX



- Content:
- Ratchet 1/4" 120T
- Sockets 1/4" (6-points profile): 4 - 4.5 - 5 - 5.5 - 6 - 7 - 8 - 9 - 10 - 11 - 12 - 13 - 14 mm
- Extensions 1/4": 3" - 6"
- Universal joint 1/4"
- Sliding T-handle 1/4", Ratchet 1/2" 120T, Extensions 1/2": 3" - 10"
- Sockets 1/2" (6-points profile): 10 - 11 - 12 - 13 - 14 - 15 - 16 - 17 - 18 - 19 - 21 - 22 - 24 mm
- Universal joint 1/2"
- Sliding T-handle 1/2"
- Combination wrenches: 6 - 7 - 8 - 9 - 10 - 11 - 12 - 13 - 14 - 15 - 16 - 17 - 18 - 19 mm

CODE	DESCRIPTION				PRICE
FMMT82827-1	FATMAX Combination set 1/4" + 1/2" 49 pcs	-	2	3 2535611828270	

COMBINATION SET 1/4" + 1/2" 41 PCS



- Content:
- Ratchet 1/4" 72T
- Sockets 1/4" (6-points profile): 5.5 - 6 - 7 - 8 - 9 - 10 - 11 - 12 - 13 - 14 mm
- Extensions 1/4": 3" - 6"
- Universal joint 1/4"
- Ratchet 1/2" 72T
- Sockets 1/2" (6 point): 10 - 11 - 12 - 13 - 14 - 15 - 16 - 17 - 18 - 19 - 21 - 22 - 24 mm
- Extensions 1/2": 3" - 10"
- Universal joint 1/2"
- Combination wrenches: 8 - 10 - 11 - 12 - 13 - 14 - 16 - 17 - 18 - 19mm

CODE	DESCRIPTION				PRICE
STMT82832-1	Combination set 1/4" + 1/2" + Combination wrenches 41-piece	-	2	3 2535611828324	

COMBINATION SET 1/4" + 1/2" 175 PCS



All parts are delivered in a molded plastic storage box

- 1/4" Drive 4mm Socket
- 1/4" Drive 5mm Socket
- 1/4" Drive 6mm Socket
- 1/4" Drive 7mm Socket
- 1/4" Drive 8mm Socket
- 1/4" Drive 9mm Socket
- 1/4" Drive 10mm Socket
- 1/4" Drive 11mm Socket
- 1/4" Drive 12mm Socket
- 1/4" Drive 13mm Socket
- 1/4" Drive 14mm Socket
- 1/2" Drive 15mm Socket
- 1/2" Drive 16mm Socket
- 1/2" Drive 17mm Socket
- 1/2" Drive 19mm Socket
- 1/2" Drive 20mm Socket
- 1/2" Drive 21mm Socket
- 1/2" Drive 22mm Socket
- 1/2" Drive 24mm Socket
- 1/2" Drive 27mm Socket
- 6mm Combination Spanner
- 8mm Combination Spanner
- 10mm Combination Spanner
- 12mm Combination Spanner
- 13mm Combination Spanner
- 14mm Combination Spanner
- 15mm Combination Spanner
- 17mm Combination Spanner
- 18mm Combination Spanner
- 19mm Combination Spanner
- 5mm Nut Driver
- 5.5mm Nut Driver
- 6mm Nut Driver
- 7mm Nut Driver
- 8mm Nut Driver
- 9mm Nut Driver
- 10mm Nut Driver
- 11mm Nut Driver
- 12mm Nut Driver
- 13mm Nut Driver
- 1/4" Drive Coupler
- 1/2" Drive 16mm Spark Plug Socket
- 1/2" Drive 21mm Spark Plug Socket
- 1/4" Drive Spinner Handle
- 1/4" Drive Extension Bar 2"
- 1/4" Drive Extension Bar 4"
- 1/2" Drive Extension Bar 5"
- 1/4" Drive Sliding T-Bar
- 1/4" Drive Universal Joint
- 10PC BIT RAIL 25MM
- 10PC BIT RAIL 25MM
- 10PC BIT RAIL 25MM
- 10PC BIT RAIL 25MM
- 10PC BIT RAIL 25MM
- 11PC BIT RAIL 25MM
- 11PC BIT RAIL 25MM
- 9PC BIT RAIL 25MM
- 10PC BIT RAIL 25MM
- 10PC BIT RAIL 25MM
- 80mm Magnetic Bit Holder
- Socket Adaptor 1/2" F x 3/8" M
- 1/4" Drive Socket - TORX-14E-4
- 1/4" Drive Socket - TORX-14E-5
- 1/4" Drive Socket - TORX-14E-6
- 1/4" Drive Socket - TORX-14E-7
- 1/4" Drive Socket - TORX-14E-8
- 3/8" Drive Socket - TORX-38E-10
- 3/8" Drive Socket - TORX-38E-11
- 3/8" Drive Socket - TORX-38E-12
- 3/8" Drive Socket - TORX-38E-14
- 3/8" Drive Socket - TORX-38E-16
- 3/8" Drive Socket - TORX-38E-18
- 1/2" Drive Socket - TORX-12E-20
- 1/2" Drive Socket - TORX-12E-22
- 8 Piece Folding Hex Key Set 1.5mm - 8mm Stanley SHT71800
- 1/4" Drive 72T Ratchet Handle
- 1/2" Drive 72T Ratchet Handle

CODE	DESCRIPTION				PRICE
STMT17380-1	1/4" + 1/2" + CW + HEX KEYS + BITS SET - 175 PCS	-	2	3253561173806	

FATMAX® SOCKET SET 1/4" + 1/2" 81 PCS

STANLEY
FATMAX



- Content:
- Ratchet 1/4": 120T
- Sockets 1/4" (6-points): 4 - 4.5 - 5 - 5.5 - 6 - 7 - 8 - 9 - 10 - 11 - 12 - 13 - 14 mm
- Long sockets 1/4" (6-points): 4 - 5 - 6 - 7 - 8 - 9 - 10 - 11 - 12 - 13 - 14 mm
- Extensions 1/4": 3" - 6"
- Universal joint 1/4"
- Bit holder 1/4"
- Spinner handle 1/4"
- Sliding T-handle 1/4"
- Bits 1/4": PZ1 - PZ2 - PZ3 - PH1 - PH2 - PH3 - 6 side 3 - 4 - 5 - 6 - 7 - Torx 10 - 15 - 20 - 25 - 27 - 30 - 40 - Slot 4 - 5-6-7
- Ratchet 1/2" 120T
- Sockets 1/2" (6-points): 8 - 10 - 11 - 12 - 13 - 14 - 15 - 16 - 17 - 18 - 19 - 20 - 21 - 22 - 23 - 24 - 27 - 30 - 32 - 34mm
- Spark plug sockets 1/2": 16 - 21 mm
- Extensions 1/2": 3" - 5"
- Sliding T-handle 1/2"
- Universal joint 1/2"

CODE	DESCRIPTION				PRICE
FMMT82826-1	FATMAX socket set 1/4" + 1/2" 81 pcs	-	2	3 2535611828263	

SOCKET SET 1/4" + 1/2" 72 PCS



- Content:
- Ratchet 1/4" 72T
- Sockets 1/4" (6-points): 5.5 - 6 - 7 - 8 - 9 - 10 - 11 - 12 - 13 - 14 mm
- Long sockets 1/4" (6-points): 6 - 7 - 8 - 9 - 10 - 11 - 12 - 13 - 14 mm
- Extensions 1/4": 3" - 6"
- Universal joint 1/4"
- Bit holder 1/4"
- Spinner handle 1/4"
- Bits 1/4": PZ1 - PZ2 - PZ3 - PH1 - PH2 - PH3 - 6 side 3 - 4 - 5 - 6 - 7 - Torx 10 - 15 - 20 - 25 - 27 - 30 - 40 - Slot 4 - 5 - 6 - 7
- Ratchet 1/2" 72T
- Sockets 1/2" (6-points): 8 - 10 - 11 - 12 - 13 - 14 - 15 - 16 - 17 - 18 - 19 - 20 - 21 - 22 - 23 - 24 - 27 - 30 - 32 mm
- Spark plug sockets 1/2": 16 - 21 mm
- Extensions 1/2": 3" - 10"
- Universal joint 1/2"

CODE	DESCRIPTION				PRICE
STMT82831-1	Socket set 1/4" + 1/2" 72 pcs	-	2	3 2535611828317	

SOCKET SET 1/4" & 1/2" - 96 PIECES



- 1/2" Sockets x 16
- 1/2" Ratchet Handle x1
- 1/2" SPK 21mm x1
- 1/2" SPK 16mm x1
- 1/2" Extension Bar 250mm x1
- 3-Way 38F*12M Adapter x1
- 1/2" Universal joint x1
- 1/2" 6 Pt. Deep Sockets x 8
- 1/4" Ratchet Handle x1
- 1/4" Spinner Handle x1
- Bits (1/4") x41
- 1/4" Extension Bar 100 mm x1
- 1/4" 6 Pt. sockets x 14
- 1/4" Bit Adapter x1
- 1/4" Universal Joint x1
- 1/4" T-Handle x1
- 1/4" Deep Socket x 5

CODE	DESCRIPTION				PRICE
STMT17379-1	Socket set 1/4" + 1/2" 96 pcs	-	2	3253561173790	

1/2" MAXIDRIVE SOCKETS

FATMAX® 1/2" X-PROFILE MAXIDRIVE SOCKETS

**STANLEY
FATMAX**

NECK-DOWN DESIGN
Facilitating the use in narrow spaces

KNURLING
Taking and using the socket easier

MAXIDRIVE PROFILE
Maximizing the contact between the socket and nut/bolt



VISIBLE DIMENSIONS
To easily identify the socket size

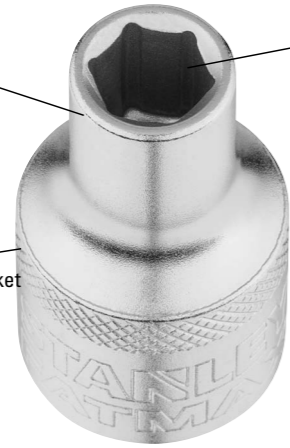

CODE	DESCRIPTION		CODE	DESCRIPTION		PRICE
FMMT17093-0	FATMAX 1/2" Socket kit 14, 15, 16 mm	3253560170936	FMMT17227-0*	FATMAX 1/2" Socket 6P 8mm	X 6 3	253560172275
FMMT17094-0	FATMAX 1/2" Socket kit 17, 18, 19 mm	3253560170943	FMMT17228-0*	FATMAX 1/2" Socket 6P 9mm	X 6 3	253560172282
FMMT17095-0	FATMAX 1/2" Socket kit 21, 22, 24 mm	3253560170950	FMMT17229-0*	FATMAX 1/2" Socket 6P 10mm	X 6 3	253560172299
			FMMT17230-0*	FATMAX 1/2" Socket 6P 11mm	X 6 3	253560172305
			FMMT17231-0*	FATMAX 1/2" Socket 6P 12mm	X 6 3	253560172312
			FMMT17232-0*	FATMAX 1/2" Socket 6P 13mm	X 6 3	253560172329
			FMMT17233-0*	FATMAX 1/2" Socket 6P 14mm	X 6 3	253560172336
			FMMT17234-0*	FATMAX 1/2" Socket 6P 15mm	X 6 3	253560172343
			FMMT17235-0*	FATMAX 1/2" Socket 6P 16mm	X 6 3	253560172350
			FMMT17236-0*	FATMAX 1/2" Socket 6P 17mm	X 6 3	253560172367
			FMMT17237-0*	FATMAX 1/2" Socket 6P 18mm	X 6 3	253560172374
			FMMT17238-0*	FATMAX 1/2" Socket 6P 19mm	X 6 3	253560172381
			FMMT17239-0*	FATMAX 1/2" Socket 6P 20mm	X 4 3	253560172398
			FMMT17240-0*	FATMAX 1/2" Socket 6P 21mm	X 4 3	253560172404
			FMMT17241-0*	FATMAX 1/2" Socket 6P 22mm	X 4 3	253560172411
			FMMT17242-0*	FATMAX 1/2" Socket 6P 23mm	X 4 3	253560172428
			FMMT17243-0*	FATMAX 1/2" Socket 6P 24mm	X 4 3	253560172435
			FMMT17244-0*	FATMAX 1/2" Socket 6P 27mm	X 4 3	253560172442
			FMMT17245-0*	FATMAX 1/2" Socket 6P 30mm	X 2 3	253560172459
			FMMT17246-0*	FATMAX 1/2" Socket 6P 32mm	X 2 3	253560172466
			FMMT17247-0*	FATMAX 1/2" Socket 6P 34mm	X 2 3	253560172473

*Not in the Nordic assortment - special order required. Minimum order quantity applied.

1/2" ACCESSORIES

FATMAX® 1/2" SOCKET EXTENSIONS

**STANLEY
FATMAX**

· Better reach in hard-to-reach places

CODE	DESCRIPTION		PRICE
FMMT25123-0*	FATMAX 1/2" Extension - 75mm	X 4 3	2535601251239
FMMT25122-0*	FATMAX 1/2" Extension - 152mm	X 4 3	2535601251222

*Not in the Nordic assortment - special order required. Minimum order quantity applied.



FATMAX® 1/2" UNIVERSAL JOINT

**STANLEY
FATMAX**

· Better reach and freedom of movement during ratcheting applications

CODE	DESCRIPTION		PRICE
FMMT17999-0*	FATMAX 1/2" Universal joint	X 4 3	253560179991

*Not in the Nordic assortment - special order required. Minimum order quantity applied.



1/2" STANLEY ESSENTIAL SOCKETS

STANLEY® 1/2" SOCKETS - ESSENTIAL

· Maximizing the contact between the socket and nut/bolt
· Polished chrome finish

CODE	DESCRIPTION		PRICE
STMT86508-0	1/2" Drive 6P Socket 8 mm	- -	3253560865085
STMT86509-0	1/2" Drive 6P Socket 9 mm	- -	3253560865092
STMT86510-0	1/2" Drive 6P Socket 10 mm	- -	3253560865108
STMT86511-0	1/2" Drive 6P Socket 11 mm	- -	3253560865115
STMT86512-0	1/2" Drive 6P Socket 12 mm	- -	3253560865122
STMT86513-0	1/2" Drive 6P Socket 13 mm	- -	3253560865139
STMT86514-0	1/2" Drive 6P Socket 14 mm	- -	3253560865146
STMT86515-0	1/2" Drive 6P Socket 15 mm	- -	3253560865153
STMT88738-0	1/2" Drive 6P Socket 16 mm	- -	3253560887384
STMT86517-0	1/2" Drive 6P Socket 17 mm	- -	3253560865177
STMT86518-0	1/2" Drive 6P Socket 18 mm	- -	3253560865184
STMT86519-0	1/2" Drive 6P Socket 19 mm	- -	3253560865191
STMT86520-0	1/2" Drive 6P Socket 20 mm	- -	3253560865207
STMT86521-0	1/2" Drive 6P Socket 21 mm	- -	3253560865214
STMT86524-0	1/2" Drive 6P Socket 24 mm	- -	3253560865245W



3/8" MAXIDRIVE SOCKETS

FATMAX® 3/8" X-PROFILE MAXIDRIVE SOCKETS

STANLEY
FATMAX

- Knurled: better grip
- Maxidrive profile: maximum contact of the cap and the nut/bolt
- Narrowed neck: more accessible in tight spaces
- Clearly visible size

CODE	DESCRIPTION				PRICE
FMMT17208-0*	FATMAX 3/8" Socket 6P 8mm	X	12	3	
FMMT17209-0*	FATMAX 3/8" Socket 6P 9mm	X	12	3	
FMMT17210-0*	FATMAX 3/8" Socket 6P 10mm	X	12	3	
FMMT17211-0*	FATMAX 3/8" Socket 6P 11mm	X	12	3	
FMMT17212-0*	FATMAX 3/8" Socket 6P 12mm	X	12	3	
FMMT17213-0*	FATMAX 3/8" Socket 6P 13mm	X	12	3	
FMMT17214-0*	FATMAX 3/8" Socket 6P 14mm	X	12	3	
FMMT17215-0*	FATMAX 3/8" Socket 6P 15mm	X	12	3	
FMMT17216-0*	FATMAX 3/8" Socket 6P 16mm	X	12	3	
FMMT17217-0*	FATMAX 3/8" Socket 6P 17mm	X	12	3	
FMMT17218-0*	FATMAX 3/8" Socket 6P 18mm	X	6	3	
FMMT17219-0*	FATMAX 3/8" Socket 6P 19mm	X	6	3	
FMMT17220-0*	FATMAX 3/8" Socket 6P 20mm	X	6	3	
FMMT17221-0*	FATMAX 3/8" Socket 6P 21mm	X	6	3	
FMMT17222-0*	FATMAX 3/8" Socket 6P 22mm	X	6	3	
FMMT17223-0*	FATMAX 3/8" Socket 6P 23mm	X	6	3	
FMMT17224-0*	FATMAX 3/8" Socket 6P 24mm	X	6	3	

*Not in the Nordic assortment - special order required. Minimum order quantity applied.



3/8" ACCESSORIES

FATMAX® 3/8" SPARK PLUG SOCKET

STANLEY
FATMAX



CODE	DESCRIPTION				PRICE
FMMT17225-0*	FATMAX 3/8" Spark Plug Socket 16mm	X	6	3	
FMMT17226-0*	FATMAX 3/8" Spark Plug Socket 21mm	X	4	3	

*Not in the Nordic assortment - special order required. Minimum order quantity applied.

FATMAX® 3/8" SOCKET EXTENSIONS

STANLEY
FATMAX



- Helps end users reach fasteners in inaccessible places.

CODE	DESCRIPTION				PRICE
FMMT25130-0*	FATMAX 3/8" Extension - 75mm	X	6	3	
FMMT25131-0*	FATMAX 3/8" Extension - 152mm	X	6	3	

*Not in the Nordic assortment - special order required. Minimum order quantity applied.

FATMAX® 3/8" UNIVERSAL JOINT

STANLEY
FATMAX



- It gives to end user greater accessibility and free range of motion during ratcheting applications

CODE	DESCRIPTION				PRICE
FMMT18011-0*	FATMAX 3/8" Universal joint	X	6	3	

*Not in the Nordic assortment - special order required. Minimum order quantity applied.

FATMAX® 3/8" BIT HOLDER

STANLEY
FATMAX



- Use 3/8" bits for screwdriving

CODE	DESCRIPTION				PRICE
FMMT18013-0*	FATMAX 3/8" Bit holder	X	12	3	

*Not in the Nordic assortment - special order required. Minimum order quantity applied.

MAXIDRIVE SOCKETS 1/4"

FATMAX® 1/4" X-PROFILE MAXIDRIVE SOCKETS



- Knurled: better grip
- Maxidrive profile: Maximizing the contact between the socket and nut/bolt
- Neck-down Design - Facilitating the use in narrow spaces
- Visible dimensions - To easily identify the socket size

CODE	DESCRIPTION				PRICE
FMMT17185-0*	FATMAX 1/4" Socket 6P 4mm	X	12		
FMMT17186-0*	FATMAX 1/4" Socket 6P 4.5mm	X	12		
FMMT17187-0*	FATMAX 1/4" Socket 6P 5mm	X	12		
FMMT17190-0*	FATMAX 1/4" Socket 6P 5.5mm	X	12		
FMMT17191-0*	FATMAX 1/4" Socket 6P 6mm	X	12		
FMMT17192-0*	FATMAX 1/4" Socket 6P 7mm	X	12		
FMMT17193-0*	FATMAX 1/4" Socket 6P 8mm	X	12		
FMMT17194-0*	FATMAX 1/4" Socket 6P 9mm	X	12		
FMMT17195-0*	FATMAX 1/4" Socket 6P 10mm	X	12		
FMMT17196-0*	FATMAX 1/4" Socket 6P 11mm	X	12		
FMMT17197-0*	FATMAX 1/4" Socket 6P 12mm	X	12		
FMMT17198-0*	FATMAX 1/4" Socket 6P 13mm	X	12		
FMMT17207-0*	FATMAX 1/4" Socket 6P 14mm	X	12		

*Not in the Nordic assortment - special order required. Minimum order quantity applied.



FATMAX® 1/4" X-PROFILE MAXIDRIVE LONG SOCKETS



- Knurled: better grip
- Maxidrive profile: Maximizing the contact between the socket and nut/bolt
- Neck-down Design - Facilitating the use in narrow spaces
- Visible dimensions - To easily identify the socket size

CODE	DESCRIPTION				PRICE
FMMT17248-0*	FATMAX 1/4" Long Socket 6P 4mm	X	12		
FMMT17249-0*	FATMAX 1/4" Long Socket 6P 5mm	X	12		
FMMT17300-0*	FATMAX 1/4" Long Socket 6P 6mm	X	12		
FMMT17337-0*	FATMAX 1/4" Long Socket 6P 7mm	X	12		
FMMT17338-0*	FATMAX 1/4" Long Socket 6P 8mm	X	12		
FMMT17339-0*	FATMAX 1/4" Long Socket 6P 9mm	X	12		
FMMT17523-0*	FATMAX 1/4" Long Socket 6P 10mm	X	12		
FMMT17963-0*	FATMAX 1/4" Long Socket 6P 11mm	X	12		
FMMT17964-0*	FATMAX 1/4" Long Socket 6P 12mm	X	12		
FMMT17965-0*	FATMAX 1/4" Long Socket 6P 13mm	X	12		
FMMT17966-0*	FATMAX 1/4" Long Socket 6P 14mm	X	12		

*Not in the Nordic assortment - special order required. Minimum order quantity applied.



FATMAX® 1/4" X-PROFILE MAXIDRIVE SOCKET SETS

- Knurled: better grip
- Maxidrive profile: Maximizing the contact between the socket and nut/bolt
- Neck-down Design - Facilitating the use in narrow spaces
- Visible dimensions - To easily identify the socket size

CODE	DESCRIPTION				PRICE
FMMT17090-0	FATMAX 1/4" Socket kit 5, 6, 7 mm	X	-		3253560170905
FMMT17091-0	FATMAX 1/4" Socket kit 5, 6, 7 mm	X	-		3253560170912
FMMT17092-0	FATMAX 1/4" Socket kit 5, 6, 7 mm	X	-		3253560170929



1/4" ACCESSORIES

FATMAX® 1/4" SOCKET EXTENSIONS

STANLEY
FATMAX



· Helps end users reach fasteners in inaccessible places

CODE	DESCRIPTION				PRICE
FMMT25125-0*	FATMAX 1/4" Extension - 75mm	X	6	3 253560 251253	
FMMT25126-0*	FATMAX 1/4" Extension - 152mm	X	6	3 253560 251260	

*Not in the Nordic assortment - special order required. Minimum order quantity applied.

FATMAX® 1/4" UNIVERSAL JOINT

STANLEY
FATMAX



· It gives to end user greater accessibility and free range of motion during ratcheting applications

CODE	DESCRIPTION				PRICE
FMMT18008-0*	FATMAX 1/4" Universal joint	X	12	3 253560 180089	

*Not in the Nordic assortment - special order required. Minimum order quantity applied.

FATMAX® 1/4" BIT HOLDER

STANLEY
FATMAX



· Use 1/4" bits for screwdriving

CODE	DESCRIPTION				PRICE
FMMT18007-0*	FATMAX 1/4" Bit holder	X	12	3 253560 180072	

*Not in the Nordic assortment - special order required. Minimum order quantity applied.

STANLEY® 1/4" BIT HOLDER



· Use 1/4" bits for screwdriving

CODE	DESCRIPTION				PRICE
STMT86124-0	Stanley 1/4" Bit holder	X	12	3253560861247	

PRO STACK SOCKET SET FOAM INLAYS

FATMAX® PRO-STACK SOCKET SET FOAM INLAY 1/2" 20 PCS

STANLEY
FATMAX



- P9 Ratchet wrench 1/2" with bi-material handle, 53T, 5°
- 1/2" Extension 127mm
- 1/2" Universal joint
- Spark plug sockets 18, 21 mm
- 1/2" 6-point sockets 10-24 mm

CODE	DESCRIPTION				PRICE
FMHT0-74297	FATMAX PRO-STACK Socket set foam inlay 1/2" - 20 pcs	-	2	3 253560 742973	

FATMAX® PRO-STACK SOCKET SET FOAM INLAY 3/8" 38 PIECES

STANLEY
FATMAX



- P9 Ratchet wrench 3/8" with bi-material handle, 53T, 5°
- 3/8" Extension 76.2mm
- 3/8" Extension 152.4mm
- 3/8" Universal joint
- 14 pcs key set: Hex 1.5, 2, 2.5, 3, 4, 4.5, 5, 6 and 7 mm
- 3/8" sockets (6-points profile) 10-19 mm
- 3/8" long sockets (6-points profile) 10-19 mm

CODE	DESCRIPTION				PRICE
FMHT0-74296	FATMAX PRO-STACK Socket set foam inlay 3/8" 38 pcs	-	2	3 253560 742966	

FATMAX® PRO-STACK INSERT SOCKET SET 1/4" 48 PCS

STANLEY
FATMAX



- P9 Ratchet wrench 1/4" with bi-material handle, 53T, 5°
- 1/4" Extension 76.2mm
- 1/4" Extension 152.4mm
- 1/4" Universal Universal joint
- Handle 1/4"
- Bit adapter 1/4"
- 20-piece bit set: Slot: 4, 6 and 8 – Phillips: PH0, PH1, PH2 and PH3 – Pozidriv: PZ1, PZ2 and PZ3 – Hex: 3, 4, 5, 6 and 8 – Torx: T10, T15, T20, T25 and T30
- 1/4" hexagonal sockets 4-14 mm
- 1/4" long sockets 6-point 4-14 mm

CODE	DESCRIPTION				PRICE
FMHT0-74295	FATMAX PRO-STACK Insert Socket Set 1/4" 48 pcs	-	2	3 253560 742959	

FATMAX® PRO-STACK COMBINATION WRENCH SET FOAM INLAY

STANLEY
FATMAX



· Combination spanners 10 - 19 mm

CODE	DESCRIPTION				PRICE
FMHT0-74298	FATMAX PRO-STACK Combination wrench set foam inlay 10 pcs	-	2	3 25356011742980	

FATMAX® PRO-STACK® SOCKET SETS

FATMAX® PRO-STACK SOCKET SET 1/2" 26 PCS

STANLEY
FATMAX



- Transparent lid for full visibility
- Durable, robust design
- Content:
 - 1x 1/2" 120T bi-material ratchet
 - 12x 1/2" sockets (6-point): 8 - 9 - 10 - 11 - 12 - 13 - 14 - 15 - 16 - 17 - 18 - 19 - 20 - 21 - 22 - 23 - 24 - 27 - 30 - 32 - 34 mm
 - 2x 1/2" extensions: 3" - 10"
 - 1x 1/2" Universal joint
 - 1x 1/2" 3-WAY Adapter for Sliding T-handle
- Can be combined with PRO-STACK and TSTAK
- Size: large

CODE	DESCRIPTION				PRICE
FMHT98103-1	FATMAX PRO-STACK Socket set 1/2" 26 pcs	-	2	3 2535611981036	

FATMAX® PRO-STACK SOCKET SET 1/4" 37 PCS

STANLEY
FATMAX



- Transparent lid for full visibility
- Durable, robust design
- Content:
 - 1x 1/4" ratchet wrench
 - 11x 1/4" sockets (6-points profile): 5 - 5.5 - 6 - 7 - 8 - 9 - 10 - 11 - 12 - 13 - 14 mm
 - 1x 1/4" socket
 - 30x 1/4" bits: Pozidriv: 1 - 2 - 3
Phillips: 1 - 2 - 3
Hex: 3 - 4 - 5 - 5.5 - 6 - 7
Slotted: 3 - 4 - 5 - 6 - 7 - 8
Tamperproof torx: 10 - 15 - 20 - 25 - 27 - 30
- Can be combined with PRO-STACK and TSTAK
- Size: small

CODE	DESCRIPTION				PRICE
FMHT19101-0	FATMAX PRO-STACK Socket set 1/4" 37 pcs	-	2	3 2535611981036	

FATMAX® PRO-STACK SOCKET SET 3/8" 18 PCS

STANLEY
FATMAX



- Transparent lid for full visibility
- Durable, robust design
- Content:
 - 1x 3/8" 120T bi-material ratchet
 - 15x 1/4" sockets (6 point): 5 - 6 - 7 - 8 - 9 - 10 - 11 - 12 - 13 - 14 - 15 - 16 - 17 - 18 - 19 mm
 - 1x 1/4" extensions: 3"
 - 1x 1/4" Universal joint
- Can be combined with PRO-STACK and TSTAK
- Size: medium

CODE	DESCRIPTION				PRICE
FMHT98102-0	FATMAX PRO-STACK Socket set 3/8" 18 pcs	X	5	3 25356011981020	

FATMAX® PRO-STACK SOCKET SET 1/4" 48 PCS

STANLEY
FATMAX



- Transparent lid for full visibility
- Durable, robust design
- Content:
 - 1x 1/4" 120T bi-material ratchet
 - 12x 1/4" sockets (6 point): 4 - 5 - 5.5 - 6 - 7 - 8 - 9 - 10 - 11 - 12 - 13 - 14 mm
 - 2x 1/4" extensions: 3" - 6"
 - 1x 1/4" bit holder
 - 1x 1/4" Universal joint
 - 1x 1/4" spinner
 - 30x 1/4" bits
- Can be combined with PRO-STACK and TSTAK
- Size: medium

CODE	DESCRIPTION				PRICE
FMMT98101-0	FATMAX PRO-STACK Socket wrench set 1/4" 48 pcs	X	5	3 2535601981013	

FATMAX® PRO-STACK COMBINATION WRENCH SET 12 PCS

STANLEY
FATMAX



- Transparent lid for full visibility
- Durable, robust design
- Content:
 - 12x Anti-slip combination wrenches: 6 - 7 - 8 - 9 - 10 - 11 - 12 - 13 - 14 - 15 - 16 - 17 mm
- Can be combined with PRO-STACK and TSTAK
- Size: medium

CODE	DESCRIPTION				PRICE
FMMT98104-0	FATMAX PRO-STACK Combination spanner set 12 pcs	X	4	3 2535601981044	

FATMAX® PRO-STACK COMBINATION WRENCH SET 12 PCS

STANLEY
FATMAX



- DRAWER 1
 - 1x 1/4" 120T bi-material ratchet
 - 13x 1/4" sockets (6-points): 4 - 4.5 - 5 - 5.5 - 6 - 7 - 8 - 9 - 10 - 11 - 12 - 13 - 14 mm
 - 11x 1/4" deep sockets (6-points): 4 - 5 - 6 - 7 - 8 - 9 - 10 - 11 - 12 - 13 - 14 mm
 - 1x Hex Key Set (14pcs) 2x 1/4" extensions: 3" - 6"
 - 1x 1/4" bit holder
 - 1x 1/4" universal joint
 - 1x 1/4" Sliding T-handle
 - 1x 1/4" spinner
 - 44x 1/4" bits:
 - Rail #1 POZIDRIV PZ1x2 - PZ2x2 - PZ3 | PHILIPPS: PH1x2 - PH2x2 - PH3x2
 - Rail #2 HEX: 1.5 - 2 - 2.5 - 3 - 4 - 5x2 - 5.5 - 6 - 7 - 8
 - Rail #3 RESISTORX: TT10 - TT15x2 - TT20x2 - TT25x2 - TT27x2 - TT30 - TT40
 - Rail #4 SLOTTED: 3 - 4 - 4.5 - 5 - 5.5x2 - 6 - 6.5x2 - 7 - 8
- DRAWER 2
 - 14x 1/4" Anti-Slip Combination Wrenches: 6 - 7 - 8 - 9 - 10 - 11 - 12 - 13 - 14 - 15 - 16 - 17 - 18 - 19
- DRAWER 3
 - 1x 1/2" 120T bi-material ratchet
 - 15x 1/2" sockets (6-points): 10 - 11 - 12 - 13 - 14 - 15 - 16 - 17 - 18 - 19 - 20 - 21 - 22 - 23 - 24 mm
 - 3x 1/2" spark plug sockets: 16 - 19 - 21 mm
 - 2x 1/2" extensions: 3" - 10" 1x 1/2" universal joint
 - 1x 1/2" 3-WAY Adapter for Sliding T-handle

CODE	DESCRIPTION				PRICE
FMMT98104-0	FATMAX PRO-STACK Combination spanner set 12 pcs	X	4	3 2535601981044	

TRANSMODULE SYSTEM

FATMAX® PLIERS SET DYNAGRIP 4 PCS

STANLEY
FATMAX



- Needle Nose Plier 200 mm
- Side cutter 150 mm
- Combination plier 180 mm
- Wire stripping plier 150 mm

CODE	DESCRIPTION				PRICE
STMT1-74179	FATMAX Transmodule Pliers Set Dynagrip 4 pcs	X	4	3 2535611741791	

FATMAX® PLIERS SET CIRCLIPS 4 PCS

STANLEY
FATMAX



- Circlip bar straight internal 1800 mm
- Circlip bar straight external 1800 mm
- Circlip bar curved internal 1800 mm
- Circlip rod bent external 1800 mm

CODE	DESCRIPTION				PRICE
STMT1-74180	FATMAX Transmodule Pliers set Circlips 4 pcs	X	4	3 2535611741807	

FATMAX® SOCKET SET 1/2" - 23 PCS

STANLEY
FATMAX



- 18 sockets (6-points profile): 8, 9, 10, 11, 12, 13, 14, 15, 16, 17, 18, 19, 21, 22, 24, 27, 30, 32mm
- 1 ratchet NP9
- 1 L handle 90°
- 2 extensions: 125 + 250 mm
- 1 Universal joint

CODE	DESCRIPTION				PRICE
STMT1-74173	FATMAX Transmodule Socket set 1/2" 6-points profile	X	4	3 2535611741739	

FATMAX® SOCKET SET 1/2" - 23 PCS

STANLEY
FATMAX



- 18 sockets (12-points profile): 8, 9, 10, 11, 12, 13, 14, 15, 16, 17, 18, 19, 21, 22, 24, 27, 30, 32mm
- 1 ratchet NP9
- 1 L handle 90°
- 2 extensions: 125 + 250 mm
- 1 Universal joint

CODE	DESCRIPTION				PRICE
STMT1-74726	FATMAX Transmodule Socket set 1/2" 12-points 23 pcs	X	4		

FATMAX® SOCKET SET 1/4" 60 PCS

STANLEY
FATMAX



- 13 sockets: 4, 4.5, 5, 5.5, 6, 7, 8, 9, 10, 11, 12, 13, 14mm
- 13 long sockets: 4, 5, 5.5, 6, 7, 8, 9, 10, 11, 12, 13, 14mm
- 3 slotted bits: 4, 5.5, 7mm
- 3 PZ bits: PZ1, PZ2, PZ3
- 3 PH bits: PH1, PH2, PH3
- 3 Hex bits: 2, 2.5, 3, 4, 5, 6mm
- 8 Torx bits: T6, T7, T8, T9, T10, T15, T20, T25
- 6 Torx sockets: E4, E5, E6, E7, E8, E10
- 1 ratchet NP9
- 1 spinner
- 2 extensions: 50, 100 mm
- 1 extension joint 125 mm
- 1 Universal joint
- 1 T handle

CODE	DESCRIPTION				PRICE
STMT1-74175	FATMAX Transmodule Socket set 1/4" 60 pcs	X	4		

FATMAX® TORX BITSET 1/2" PROFILE 24 PCS

STANLEY
FATMAX



- 9 Torx socket bits: T20, T25, T27, T30, T40, T45, T50, T55, T60
- 6 Torx long socket bits: T30, T40, T45, T50, T55, T60
- 9 Torx sockets (6-points profile): E10, E11, E12, E14, E16, E18, E20, E22, E24

CODE	DESCRIPTION				PRICE
STMT1-74176	FATMAX Transmodule Torx Bitset 1/2" - 24-piece	X	4		

FATMAX® OFFSET DOUBLE RING WRENCH SET - 10 PCS

STANLEY
FATMAX



- 10 ring wrenches: 6 x 7 mm, 8 x 9 mm, 10 x 12 mm, 11 x 13 mm, 12 x 14 mm, 14 x 15 mm, 16 x 17 mm, 18 x 19 mm, 21 x 23 mm, 22 x 24mm

CODE	DESCRIPTION				PRICE
STMT1-74177	FATMAX Transmodule Ring wrench set 10 pcs	X	4		

FATMAX® SOCKET SET 3/8" - 36 PCS

STANLEY
FATMAX



- 14 sockets (12-points profile): 8, 9, 10, 11, 12, 13, 14, 15, 16, 17, 18, 19, 21, 22mm
- 13 long sockets (6-points profile): 8, 10, 11, 12, 13, 14, 15, 16, 17, 18, 19, 21, 22 mm
- 3 hex bit sockets: 4, 5, 6 mm
- 3 Torx bit sockets: T25, T30, T40
- 1 extension 125 mm
- 1 Universal joint
- 1 ratchet NP9

CODE	DESCRIPTION				PRICE
STMT1-74174	FATMAX Transmodule Socket set 3/8" 36 pcs	X	4		

FATMAX® COMBINATION WRENCH SET 10 PCS

STANLEY
FATMAX



- 16 combination wrenches: 6mm, 7mm, 8mm, 9mm, 10mm, 11mm, 12mm, 13mm, 14mm, 15mm, 16mm, 17mm, 18mm, 19mm, 22mm, 24mm

CODE	DESCRIPTION				PRICE
STMT1-74178	FATMAX Transmodule Combination wrench Set	X	4		

FATMAX® CUSHIONGRIP SCREWDRIVER SET 8 PCS

STANLEY
FATMAX



- 4 Cushion Grip Slotted Screwdrivers: 3x100mm, 5x150mm (parallel), 6.5x150mm, 8x200mm
- 4 Cushion Grip Phillips screwdrivers: PH0 x 60mm, PH1 x 100mm, PH2 x 125mm, PH3 x 150mm

CODE	DESCRIPTION				PRICE
STMT1-74181	FATMAX Transmodule CushionGrip Screws wrench set 8 pcs	X	4		

FATMAX® CUSHION GRIP SCREWDRIVER SET TORX 6 PCS

STANLEY
FATMAX



- 6 Cushion Grip Screwdrivers Torx: T10 x 80mm, T15 x 80mm, T20 x 120mm, T25 x 120mm, T30 x 120mm, T40 x 120mm

CODE	DESCRIPTION				PRICE
STMT1-74182	FATMAX Transmodule CushionGrip Screws wrench set Torx 6 pcs	X	4		

TOOL CABINET WITH 7 DRAWERS

STANLEY
FATMAX



- 2 medium and 5 shallow drawers for organizing your tools and accessories
- Durable work surface, ideal for storing small parts and accessories
- Worktop with integrated handles
- Durable drawers with ball bearing slides, also for storing heavier tools
- With non-slip drawer lining
- Lockable with key on the side for safe storage of the tool
- Lockable wheels for easy mobility and safety
- Made in France
- Load capacity: 300kg total, 20kg per drawer
- Dimensions: L73.5 x H89 x W51.5 cm

CODE	DESCRIPTION				PRICE
STST74305-1	FATMAX Tool Cabinet with 5 drawers	-	1		
STST74306-1	FATMAX Tool Cabinet with 7 drawers	-	1		

NEW

SELF GRIPPING OIL FILTER WRENCH



- For oil filters
- 3/8" drive bit
- Capacity : 65-110mm
- Adjusts to fit most oil filters from 63,5 to 121 mm

CODE	DESCRIPTION				PRICE
STHT80880-0	Self Gripping Oil Filter Wrench	-	-		3253560808808

DRAIN PLUG WRENCH



- 8 and 10 mm drive bits
- Designed for use on:
- 8mm : Citroen, Peugeot, Renault, Talbot, Volvo
- 10mm: For gear boxes on different cars (BMW, Ford, Renault, Toyota)

CODE	DESCRIPTION				PRICE
STHT80879-0	Drain Plug Wrench	-	-		3253560808792

DIESEL GLOW PLUG SOCKETS



- 8 and 10 mm drive bits
- Designed for use on:
- 8mm : Citroen, Peugeot, Renault, Talbot, Volvo
- 10mm: For gear boxes on different cars (BMW, Ford, Renault, Toyota)

CODE	DESCRIPTION				PRICE
STHT80888-0	Diesel Glow Plug 8 mm	-	-		3253560808792
STHT81015-0	Diesel Glow Plug 9 mm	-	-		3253560810153
STHT81016-0	Diesel Glow Plug 10 mm	-	-		3253560810160

OIL BITS



- Used to make the oil change on cars
- 3/8" Oil drain bits
- 8 different sizes to fits with most common car brands

CODE	DESCRIPTION				PRICE
STHT81574-0	Oil bit HEX 8 mm	-	-		3253560815745
STHT81575-0	Oil bit HEX 10 mm	-	-		3253560815752
STHT81576-0	Oil bit HEX 12 mm	-	-		3253560815769
STHT81577-0	Oil bit HEX 13 mm	-	-		3253560815776
STHT81578-0	Oil bit HEX 14 mm	-	-		3253560815783
STHT81579-0	Oil bit HEX 17 mm	-	-		3253560815790
STHT81580-0	Oil bit SQUARE 8 mm	-	-		3253560815806
STHT81581-0	Oil bit SQUARE 10 mm	-	-		3253560815813

PETROL SPARK PLUG SOCKETS



- Sockets used to change the spark plugs on a petrol engine car.
- 3/8" Petrol Spark plugs – 14 & 16 mm
- 2 different sizes to fits with most common petrol car brands

CODE	DESCRIPTION				PRICE
STHT81582-0	Petrol Spark Plug 14 mm	-	-		3253560815820
STHT81583-0	Petrol Spark Plug 16 mm	-	-		3253560815837

TELESCOPIC WHEEL TOOL



- Telescopic handle to unscrew wheel bolts
- Telescopic handle to more torque
- 2 sockets: 17/19 mm, 21/23 mm

CODE	DESCRIPTION				PRICE
STHT80890-0	Telescopic Wheel Tool	-	-	3253560808907	

DIGITAL TIRE PRESSURE GAUGE



- Easy to Read Digital Display
- Comfort Grip Handle
- Automotive Chemical Resistant Materials
- Integrated LED for Use at Night or Dark Areas
- Measures : 3-150psi | 0,2-10,3Bar | 20,7-1034 KPA | 0,21-10,5kg/cm²

CODE	DESCRIPTION				PRICE
STHT80874-0	Digital Tire Pressure Gauge	-	-	3253560808747	

FLAT TIRE REPAIR KIT



- 4 Cushion Grip Slotted Screwdrivers: 3x100mm, 5x150mm (parallel), 6.5x150mm, 8x200mm
- 4 Cushion Grip Phillips screwdrivers: PH0 x 60mm, PH1 x 100mm, PH2 x 125mm, PH3 x 150mm

CODE	DESCRIPTION				PRICE
STHT80891-0	Flat Tire Repair Kit	-	-	3253560808914	

AXEL STANDS - 2 TON



- 2T axle stands
- Min height: 278 mm / Max Height: 430 mm
- Safety pins
- Foot pads for more stability
- High quality ratchet bar to work in safety conditions

CODE	DESCRIPTION				PRICE
STMT81255-1	Axel Stands - 2 ton	-	-	3253561812552	

BRAKE WIND BACK CUBE



- Used to return piston when replacing pads
- 3/8" square drive
- Fits five different piston cavity configurations operation on different cars brands

CODE	DESCRIPTION				PRICE
STHT80883-0	Brake Wind Back Cube	-	-	3253560808839	

FOOT PUMP



- High Pressure Cylinder Foot Pump
- Can be used for cars, bikes, balloons... (adapters supplied)
- Compact Size - no need too much room in your car
- Lightweight about 1kg

CODE	DESCRIPTION				PRICE
STMT1-74181	Foot Pump	-	-	3253561741814	

OIL DRAINER 15L



- Capacity 15 liters
- Impact and hydrocarbon-resistant
- To be used for floor oil change

CODE	DESCRIPTION				PRICE
STHT80878-1	Oil Drainer	-	-	3253561741814	

FLOOR JACK - 2 TON



- 2T Floor Jack
- Min height: 85 mm / Max Height: 381 mm
- 360 degree swivel saddle for solid load contact
- Lightweight for fast positioning and maneuverability
- Rust resistant finish for long life
- Easy to carry light with handle

CODE	DESCRIPTION				PRICE
STMT81251-1	Floor Jack - 2 ton	-	-	3253561812514	

3 IN 1 – AUTOMOTIVE MULTI TOOL



- 3/8" Square drive for oil filter / spark plugs / brakes operations / oil drain bits
- 1/4" for accessories
- Can be used with generic tools for automotive repair (bits / sockets)

CODE	DESCRIPTION				PRICE
STHT80872-0	3 in 1 – Automotive Multi tool	-	-	3253560808723	

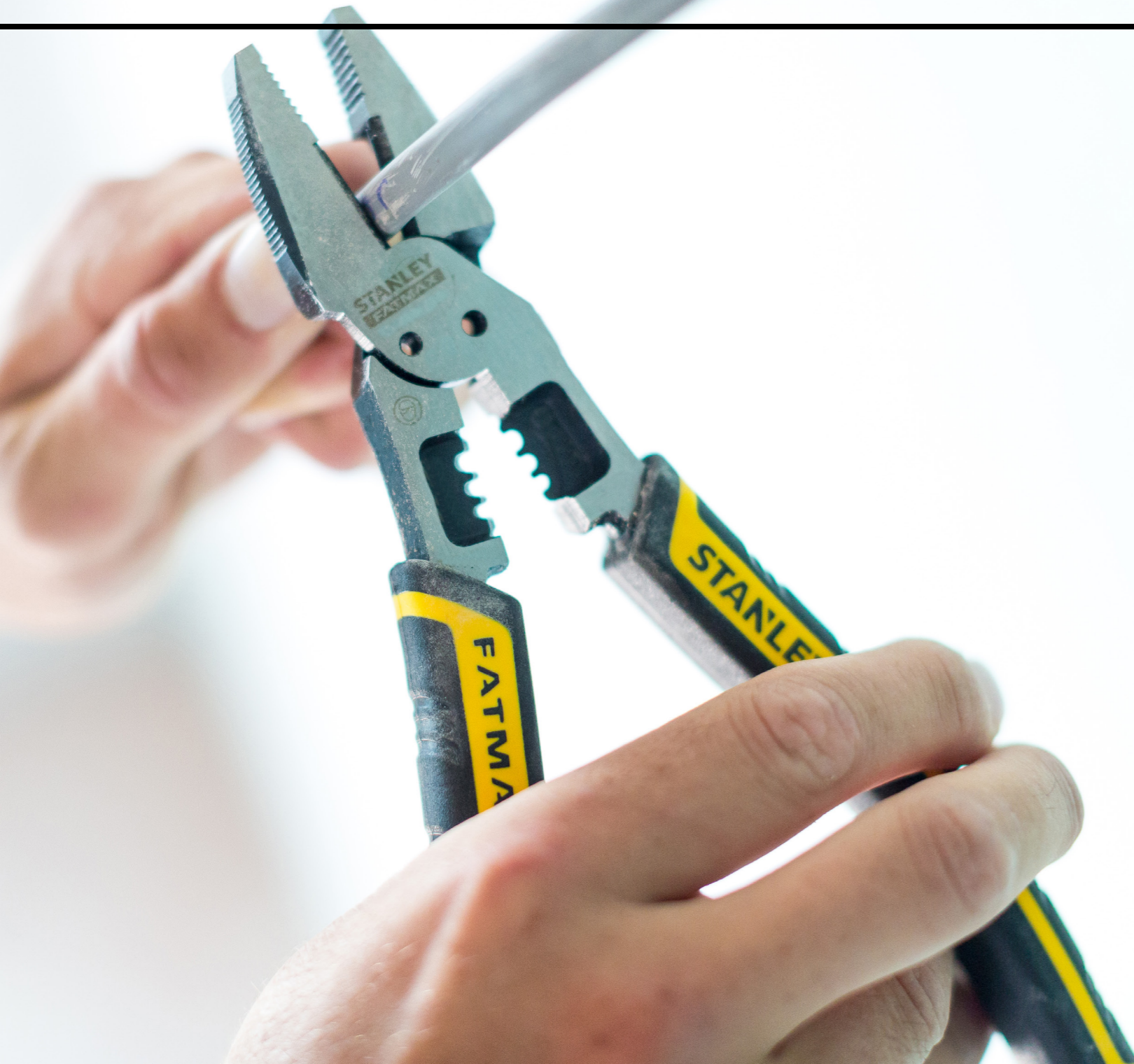

PRACTICAL INFO

OUR ASSORTIMENT

STANLEY



Carbon steel
Hardened jaws
Polished head

STANLEY DYNAGRIP



Carbon steel
Bi-material handle for comfort
Induction hardened jaws
Polished and clear lacquered head

STANLEY FATMAX



Carbon steel construction
Bi-material handle for comfort
Induction hardened jaws and
lacquered basin
DIN / ASO / ANSI standards
"Precision Machined Finish"

POWER



MULTI-USE



MINI



VDE



PLIERS AND SNIPS

The great appeal - in fact the entire point - of pliers and adjustable wrenches is handiness. They should be versatile, durable and designed to accomplish tasks efficiently. STANLEY's are.

STANLEY® pliers and snips are available in a range of sizes, handles, and types for multiple applications in sets or single units.

FATMAX® PLIERS

FATMAX® COMBINATION PLIERS

**STANLEY
FATMAX**



FMHT0-81161

CODE	DESCRIPTION	✉	☒	📊	PRICE
FMHT0-70813	FATMAX Combination Pliers 215 mm	X	6	3 253560 708139	
FMHT0-81161	FATMAX Pliers kit - Side cutter 160 mm, 180 mm Combination pliers, 160 mm Long nose pliers	-	-	3253560811617	

FATMAX® SIDE CUTTER - END CUTTER - LONG NOSE PLIERS -

**STANLEY
FATMAX**



CODE	DESCRIPTION	✉	☒	📊	PRICE
FMHT0-70814	FATMAX Side Cutter 200 mm	X	6	3 253560 708146	
FMHT0-71851	FATMAX End Cutter 190 mm	X	6	3 253560 718510	
FMHT0-70812	FATMAX Long Nose Pliers 205 mm	X	6	3 253560 708122	

FATMAX® DIAGONAL CUTTING PLIERS 5-IN-1

**STANLEY
FATMAX**

Crimping: 1.5 mm² - 2.5 mm³
Wire stripping: 1.5 mm² - 2.5 mm³
Bolt Cutter: M3 and M4
Side cutter for precise cutting of soft materials
Side cutter suitable for 1.8 mm piano wire



CODE	DESCRIPTION	✉	☒	📊	PRICE
FMHT0-75468*	FATMAX Diagonal Cutting Pliers 5in1 180mm	X	2	3 253560 754686	

**Not in the Nordic assortment - special order required. Minimum order quantity applied.*

FATMAX® UNIVERSAL PLIERS 6-IN-1

**STANLEY
FATMAX**

Wire stripper: 2.5 mm², 4 mm², 6 mm²
Universal side cutter: designed to cut wires up to and including 2.0mm Piano Wire
Bolt Cutter: M3 and M4
Combination pliers
Wrench feature - multi-point grip to tighten nuts and bolts with a hexagonal head



CODE	DESCRIPTION	✉	☒	📊	PRICE
FMHT0-75469*	FATMAX Universal pliers 6in1 200 mm	X	2	3 253560 754693	

**Not in the Nordic assortment - special order required. Minimum order quantity applied.*

FATMAX® MINI COMBINATION PLIERS

STANLEY
FATMAX

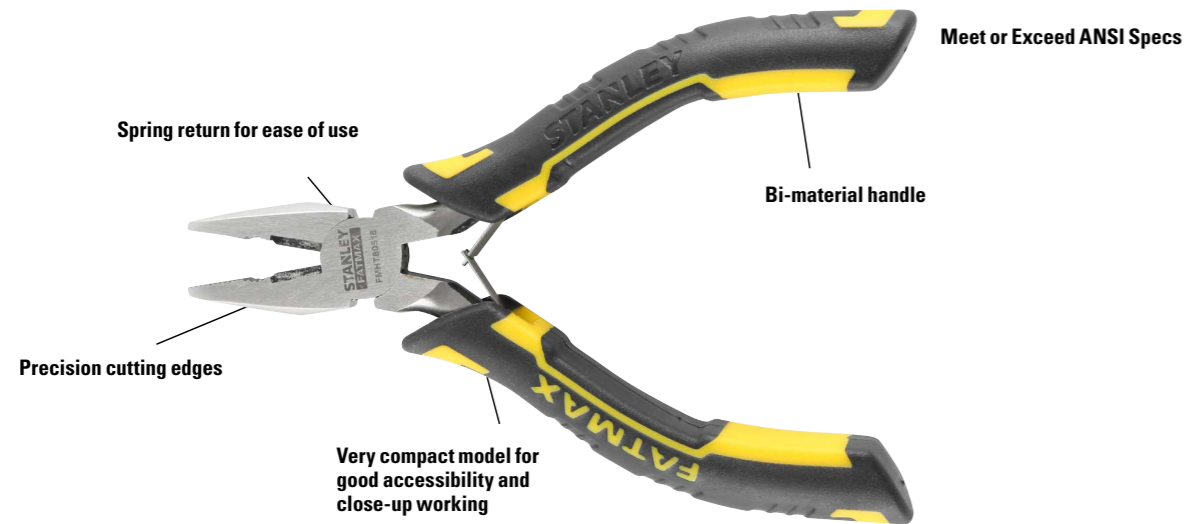

CODE	DESCRIPTION				PRICE
FMHT0-80516	FATMAX Mini Combination Pliers 190 mm	X	6		

FATMAX® MINI LONG NOSE PLIERS

STANLEY
FATMAX



CODE	DESCRIPTION				PRICE
FMHT0-80517	FATMAX Mini Long nose Pliers 125 mm	X	6		

FATMAX® MINI SIDE CUTTER

STANLEY
FATMAX



CODE	DESCRIPTION				PRICE
FMHT0-80518	FATMAX Mini Side Cutter 120 mm	X	6		

FATMAX® MINI END CUTTER

STANLEY
FATMAX



CODE	DESCRIPTION				PRICE
FMHT0-80519	FATMAX Mini End Cutter 190 mm	X	6		

FATMAX® MINI LONG NOSE PLIERS

STANLEY
FATMAX



CODE	DESCRIPTION				PRICE
FMHT0-80520	FATMAX Mini Long Nose Pliers 190 mm	X	6		

FATMAX® MINI CURVED LONG NOSE PLIERS

STANLEY
FATMAX



CODE	DESCRIPTION				PRICE
FMHT0-80523	FATMAX Mini Curved Long Nose Pliers 190 mm	X	6		

FATMAX® COMBINATION PLIERS

STANLEY
FATMAX



CODE	DESCRIPTION				PRICE
0-89-866	FATMAX Combination pliers Maxsteel 160 mm	X	10	3	2535601898663
0-89-867	FATMAX Combination pliers Maxsteel 180 mm	X	10	3	2535601898670
0-89-868	FATMAX Combination pliers Maxsteel 200 mm	X	8	3	2535601898687

FATMAX® POWER DIAGONAL CUTTERS

STANLEY
FATMAX



CODE	DESCRIPTION				PRICE
0-89-860	FATMAX Power Diagonal Cutter Maxsteel 160 mm	X	10	3	2535601898601
0-89-861	FATMAX Power Diagonal Cutter Maxsteel 200 mm	X	10	3	2535601898618

FATMAX® DIAGONAL CUTTERS

STANLEY
FATMAX



CODE	DESCRIPTION				PRICE
0-89-858	FATMAX Diagonal Cutter Maxsteel 160 mm	X	10	3	2535601898588
0-89-859	FATMAX Diagonal Cutter Maxsteel 200 mm	X	10	3	2535601898595

FATMAX® END CUTTER

STANLEY
FATMAX



CODE	DESCRIPTION				PRICE
0-89-875	FATMAX End cutter Maxsteel 160 mm	X	10	3	2535601898755

FATMAX® STRAIGHT LONG NOSE PLIERS

STANLEY
FATMAX



CODE	DESCRIPTION				PRICE
0-89-869	FATMAX Straight Long nose Pliers Maxsteel 160 mm	X	10	3	2535601898694
0-89-870	FATMAX Straight Long nose Pliers Maxsteel 200 mm	X	10	3	2535601898700

FATMAX® CURVED LONG NOSE PLIERS

STANLEY
FATMAX



CODE	DESCRIPTION				PRICE
0-89-871	FATMAX Curved Long nose Pliers Maxsteel 160 mm	X	4	3	2535601898717
0-89-872	FATMAX Curved Long nose Pliers Maxsteel 200 mm	X	10	3	2535601898724

FATMAX® FLAT LONG NOSE PLIERS

STANLEY
FATMAX



CODE	DESCRIPTION				PRICE
0-84-495	FATMAX flat long nose pliers 160 mm	X	10	3	2535601844950

FATMAX® ROUND LONG NOSE PLIERS

STANLEY
FATMAX



CODE	DESCRIPTION				PRICE
0-84-496*	FATMAX Round Long nose pliers 160 mm	X	10	3	2535601844967

*Not in the Nordic assortment - special order required. Minimum order quantity applied.

FATMAX® WIRE STRIPPER

STANLEY
FATMAX



CODE	DESCRIPTION				PRICE
0-89-873	FATMAX Wire Stripper Maxsteel 160 mm	X	10		

FATMAX® CABLE CUTTER

STANLEY
FATMAX



CODE	DESCRIPTION				PRICE
0-89-874	FATMAX Cable cutter Maxsteel 215 mm	X	4		

FATMAX® WATER PUMP PLIERS PUSHLOCK

STANLEY
FATMAX



- Easy to use patented PUSHLOCK™ adjustment button
- Fully adjustable in 17 positions
- Optimised jaw geometry for multiple gripping applications
- Induction hardened jaws
- Ergonomic bi-material handle
- Jaw Capacity: 200mm to 50mm, 250mm to 62mm, 300mm to 75mm

CODE	DESCRIPTION				PRICE
0-84-647	FATMAX Water pump pliers 200 mm	X	4		
0-84-648	FATMAX Water pump pliers 250 mm	X	4		
0-84-649	FATMAX Water pump pliers 300 mm	X	4		

FATMAX® MOTOR PLIERS

STANLEY
FATMAX



- Easy to use patented PUSHLOCK™ adjustment button
- 3 lockable positions
- Laser marking for identification 3 positions
- Induction hardened jaws
- Ergonomic bi-material handles

CODE	DESCRIPTION				PRICE
0-84-645*	FATMAX Motor Pliers 150 mm	X	4		
0-84-646*	FATMAX Motor Pliers 200 mm	X	4		

*Not in the Nordic assortment - special order required. Minimum order quantity applied.

DYNAGRIP® PLIERS

DYNAGRIP® COMBINATION PLIERS

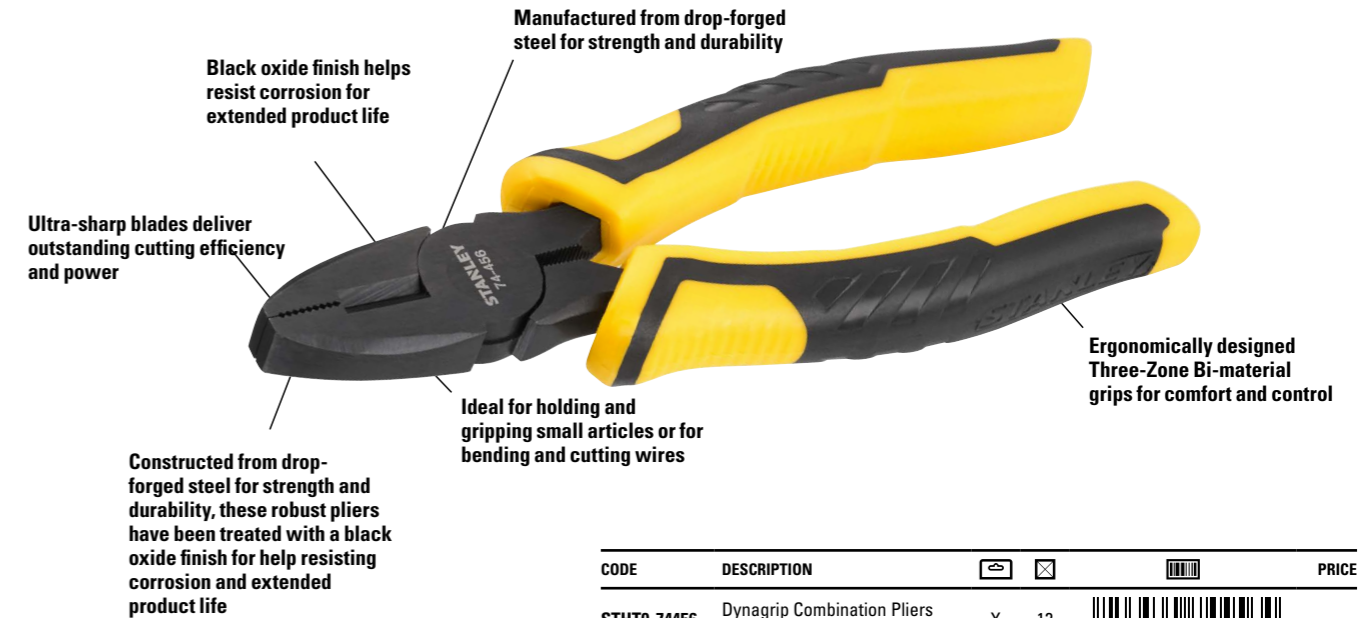

CODE	DESCRIPTION				PRICE
STHT0-74456	Dynagrip Combination Pliers 150 mm	X	12		
STHT0-74454	Dynagrip Combination pliers 180 mm	X	12		
STHT0-74367*	Dynagrip Combination Pliers 200 mm	X	12		

*Not in the Nordic assortment - special order required. Minimum order quantity applied.

DYNAGRIP® WATER PUMP PLIERS 250 MM



CODE	DESCRIPTION				PRICE
STHT0-74361	Dynagrip Water pump pliers 250 mm	X	6		

DYNAGRIP® SIDE CUTTER



CODE	DESCRIPTION				PRICE
STHT0-74362	Dynagrip Side Cutter 150 mm	X	12		
STHT0-74455	Dynagrip Side Cutter 180 mm	X	12		

DYNAGRIP® END CUTTER - 150 MM



CODE	DESCRIPTION				PRICE
STHT0-75067*	Dynagrip Head cutter 150 mm	X	12		

*Not in the Nordic assortment - special order required. Minimum order quantity applied.

DYNAGRIP® WIRE STRIPPER - 150 MM



CODE	DESCRIPTION				PRICE
STHT0-75068	Dynagrip stripping tool 150 mm	X	12		

DYNAGRIP® LONG NOSE PLIERS



CODE	DESCRIPTION				PRICE
STHT0-74363	Dynagrip Long nose Pliers 150 mm	X	12		
STHT0-74364	Dynagrip Long nose Pliers 200 mm	X	12		

WATERPUMP PLIER - 240MM



- Black phosphate finish
- Browned head
- Branches sheathed with yellow PVC
- Equipped with a safety stop
- finger guard for better control & added user safety
- Interlocking joint assembly for smooth cutting
- Interposed hinge and double adjustment - 7 positions

CODE	DESCRIPTION				PRICE
2-84-017	WATERPUMP PLIER 240MM	X	12		3253562840172

VDE PLIERS

VDE COMBINATION PLIERS

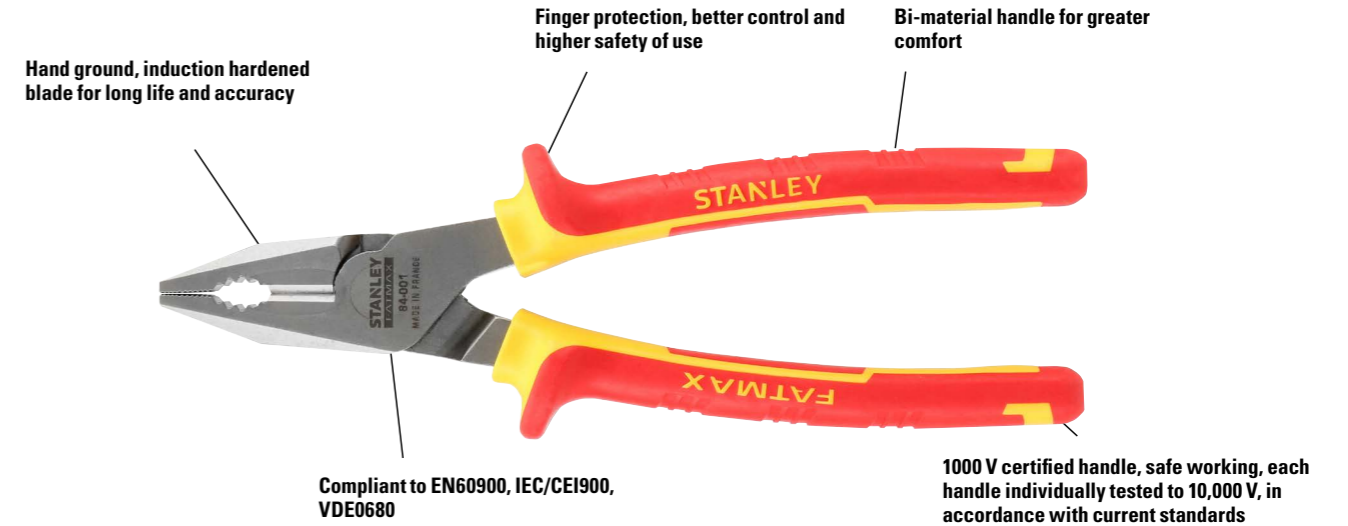

CODE	DESCRIPTION				PRICE
0-84-000*	VDE 1000 V Combination pliers 160 mm	X	10		
0-84-001*	VDE 1000 V Combination pliers 180 mm	X	10		
0-84-002*	VDE 1000 V Combination pliers 200 mm	X	8		

*Not in the Nordic assortment - special order required. Minimum order quantity applied.

VDE POWER SIDE CUTTER



CODE	DESCRIPTION				PRICE
0-84-003	VDE 1000 V Power side cutter 180 mm	X	4		
0-84-004*	VDE 1000 V Power side cutter 195 mm	X	4		

*Not in the Nordic assortment - special order required. Minimum order quantity applied.

VDE LONG NOSE PLIERS



CODE	DESCRIPTION				PRICE
0-84-006*	VDE 1000V Long nose 160 mm	X	4		
0-84-007	VDE 1000 V Long nose pliers 200 mm	X	4		

*Not in the Nordic assortment - special order required. Minimum order quantity applied.

VDE CURVED LONG NOSE PLIERS



CODE	DESCRIPTION				PRICE
0-84-008	VDE 1000 V Curved Long nose Pliers 200 mm	X	10	2 5 3 5 6 0 8 4 0 0 8 2	

VDE SIDE CUTTER



CODE	DESCRIPTION				PRICE
0-84-009	VDE 1000 V Side cutter 160 mm	X	10	2 5 3 5 6 0 8 4 0 0 9 9	

VDE WIRE STRIPPER



CODE	DESCRIPTION				PRICE
0-84-010	VDE 1000 V Wire stripper 170 mm	X	10	2 5 3 5 6 0 8 4 0 1 0 5	

VDE END CUTTER



CODE	DESCRIPTION				PRICE
0-84-016*	VDE 1000 V End cutter 160 mm	X	10	2 5 3 5 6 0 8 4 0 1 6 7	

*Not in the Nordic assortment - special order required. Minimum order quantity applied.

PLIERS SET

FATMAX® POWER TONGS SET - 40% MORE POWER 3 PCS

STANLEY
FATMAX

- Double hinge construction for more cutting power
- Additional power transmission
- Carbon steel construction
- Conforms to ANSI specifications
- Bi-material handle
- 40% more power than regular pliers



CODE	DESCRIPTION				PRICE
FMHT0-72415	FATMAX Power tongs set 3-piece	X	6	2 5 3 5 6 0 7 2 4 1 5 3	

FATMAX® MINI PLIERS SET 6 PCS

STANLEY
FATMAX

- Very compact model for work on small workpieces or in confined spaces
- Ergonomic bi-material handle
- Opening spring to operate float
- Precision cutting edges

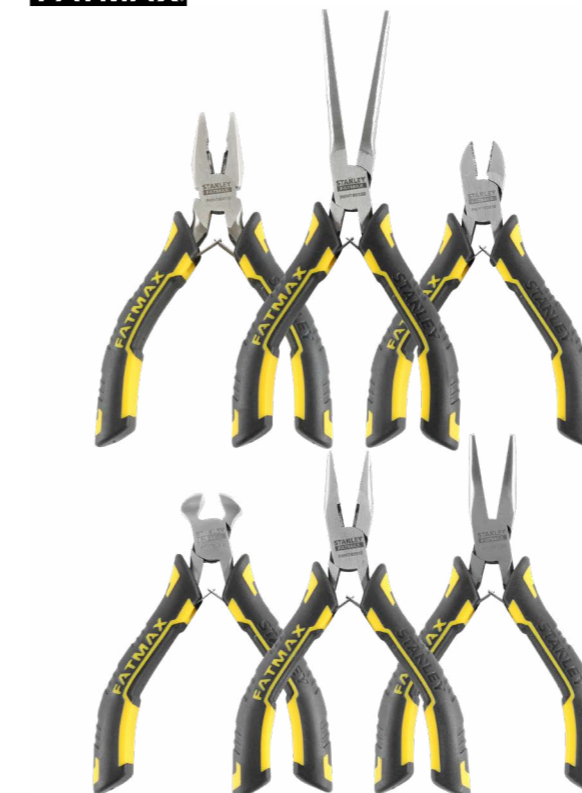

CODE	DESCRIPTION				PRICE
FMHT0-80541	FATMAX Mini Pliers Set 6 pcs	X	6	2 5 3 5 6 0 8 0 5 4 1 8	

FATMAX® MINI PLIERS SET 3 PCS

STANLEY
FATMAX

- Very compact model for work on small workpieces or in confined spaces
- Ergonomic bi-material handle
- Opening spring to operate float
- Precision cutting edges



CODE	DESCRIPTION				PRICE
FMHT0-80524	FATMAX Mini Pliers Set 3 pcs	X	6	3 253560 805241	

FATMAX® PLIERS SET 3 PCS

STANLEY
FATMAX

- Contents: Straight Long nose Pliers 160 mm, Combination Pliers 180 mm, Side Cutter 160 mm



CODE	DESCRIPTION				PRICE
4-84-488	FATMAX Pliers Set 3 pcs	X	6	3 253564 844888	



VDE PLIERS SET 4 PCS

- Contents: combination pliers 160 mm, side cutter 175 mm, Long nose pliers 160 mm, stripping pliers 170 mm



CODE	DESCRIPTION				PRICE
4-84-489	VDE pliers set 4 pcs	X	4	3 253564 844895	



DYNAGRIP® PLIERS SET WATER PUMP PLIERS 3-PIECE

- Contents: combination pliers 150 mm, side cutter 150 mm, water pump pliers 250 mm



CODE	DESCRIPTION				PRICE
STHT0-74471	Dynagrip Pliers Set CG Water Pump Pliers 3-piece	X	6	3 253560 744717	

DYNAGRIP® PLIERS SET CG 150 MM 3 PCS

- Contents: combination pliers 150 mm, side cutter 150 mm, Long nose pliers 150 mm



CODE	DESCRIPTION				PRICE
STHT0-75094	Dynagrip Pliers Set CG 150 mm 3 pcs	X	12	3 253560 750947	

BASIC PLIERS SET

- Comfortable handle
- Forged and hardened carbon steel
- Hardened jaws
- Polished head
- 152mm adjustable combination pliers (2 positions), 152mm Long nose pliers, 152mm side cutter



CODE	DESCRIPTION				PRICE
0-84-114	Basic Pliers Set	X	4	3 253560 841140	

BASIC PLIERS SET WITH WATER PUMP PLIERS

- Comfortable handle
- Forged and hardened carbon steel
- Hardened jaws
- Polished head
- 152mm adjustable combination pliers (2 positions), 152mm Long nose pliers, 254mm water pump pliers



CODE	DESCRIPTION				PRICE
0-84-892	Basic Pliers Set With Water Pump Pliers	X	4	3 253560 848927	

LOCKING PLIERS

LOCKING PLIERS CURVED JAW



- Anti-rust chrome housing
- Accurately machined jaw
- Clamping force adjustable with screw
- Quick release lever

CODE	DESCRIPTION				PRICE
0-84-808	Locking Pliers Curved Jaws 185 mm (L) 36 mm (Jaw)	-	4	3	2 5 3 5 6 0 8 4 8 0 8 8
0-84-809	Locking Pliers Curved Jaws 225 mm (L) 53 mm (Jaw)	-	4	3	2 5 3 5 6 0 8 4 8 0 9 5

LOCKING PLIERS STRAIGHT JAW



- Anti-rust chrome housing
- Accurately machined jaw
- Clamping force adjustable with screw
- Quick release lever

CODE	DESCRIPTION				PRICE
0-84-810	Locking Pliers Straight Jaws 190 mm (L) 38 mm (Jaw)	-	4	3	2 5 3 5 6 0 8 4 8 1 0 1
0-84-811	Locking Pliers Straight Jaws 225 mm (L) 50 mm (Jaw)	-	4	3	2 5 3 5 6 0 8 4 8 1 1 8

LOCKING PLIERS LONG JAW



- Anti-rust chrome housing
- Accurately machined jaw
- Clamping force adjustable with screw
- Quick release lever

CODE	DESCRIPTION				PRICE
0-84-812	Locking Pliers Long Jaws 170 mm (L) 62 mm (Jaw)	-	4	3	2 5 3 5 6 0 8 4 8 1 2 5
0-84-813*	Locking Pliers Long Jaws 215 mm (L) 75 mm (Jaw)	-	4	3	2 5 3 5 6 0 8 4 8 1 3 2

*Not in the Nordic assortment - special order required. Minimum order quantity applied.

LOCKING PLIERS "V" JAW



- Anti-rust chrome housing
- Accurately machined jaw
- Toothing all over the mouth
- Clamping force adjustable with screw
- Quick release lever

CODE	DESCRIPTION				PRICE
0-84-814*	Locking Pliers "V" Jaws 225 mm (L) 47 mm (Jaw)	-	4	3	2 5 3 5 6 0 8 4 8 1 4 9

*Not in the Nordic assortment - special order required. Minimum order quantity applied.

LOCKING PLIERS "C" JAW



- Anti-rust chrome housing
- Accurately machined jaw
- Toothing all over the mouth
- Clamping force adjustable with screw
- Quick release lever

CODE	DESCRIPTION				PRICE
0-84-816*	Locking Pliers "C" Jaws 285 mm (L) 90 mm (Jaw)	-	4	3	2 5 3 5 6 0 8 4 8 1 6 3
0-84-815	Locking Pliers "C" Jaws 170 mm (L) 45 mm (Jaw)	-	4	3	2 5 3 5 6 0 8 4 8 1 5 6

*Not in the Nordic assortment - special order required. Minimum order quantity applied.

LOCKING PLIERS WITH LARGE JAW



- Forged combined straight and curved jaws for clamping to a variety of shaped surfaces throughout the industry
- Wide opening jaws with 4 positions
- Acts as a "third man" in many applications
- Knurled adjusting nut to adjust the clamping pressure
- Quick release lever
- Nickel-coated pressed steel handles
- Textured handle to improve grip even with oily hands

CODE	DESCRIPTION				PRICE
1-84-199*	Locking pliers Large Jaw 250 mm	-	1	3	2 5 3 5 6 1 8 4 1 9 9 6

*Not in the Nordic assortment - special order required. Minimum order quantity applied.

FATMAX® LOCKING PLIERS

FATMAX® LOCKING PLIERS CURVED JAWS

STANLEY
FATMAX



- Easy release - when the TRULOCK is disengaged the squeeze to release
- Security - no accidental release due to TRULOCK
- Eyebolts for higher torque tightening and faster winding
- Firm grip - optimised jaw and tooth geometry design
- New rust resistant black finish on high-performance steel for a longer life
- Induction hardened CR-V Jaws for long-life

CODE	DESCRIPTION				PRICE
FMHT0-75409	FATMAX Locking Pliers Curved Jaws 180 mm	X	4		
FMHT0-74886	FATMAX Locking Pliers Curved Jaws 250 mm	-	2		

FATMAX® LOCKING PLIERS STRAIGHT JAWS

STANLEY
FATMAX



- Easy release - when the TRULOCK is disengaged the squeeze to release
- Security - no accidental release due to TRULOCK
- Eyebolts for higher torque tightening and faster winding
- Firm grip - optimised jaw and tooth geometry design
- New rust resistant black finish on high-performance steel for a longer life
- Induction hardened CR-V Jaws for long-life

CODE	DESCRIPTION				PRICE
FMHT0-75467	FATMAX Locking Pliers Straight Jaws 180 mm	X	4		
FMHT0-74884	FATMAX Locking Pliers Straight Jaws 250 mm	-	2		

FATMAX® LOCKING PLIERS LONG JAWS

STANLEY
FATMAX



- Easy release - when the TRULOCK is disengaged the squeeze to release
- Security - no accidental release due to TRULOCK
- Eyebolts for higher torque tightening and faster winding
- Firm grip - optimised jaw and tooth geometry design
- New rust resistant black finish on high-performance steel for a longer life
- Induction hardened CR-V Jaws for long-life

CODE	DESCRIPTION				PRICE
FMHT0-75438	FATMAX Grip Pliers Long Jaws 150 mm	X	4		
FMHT0-74888	FATMAX Grip Pliers Long Jaws 220 mm	-	2		

FATMAX® LOCKING PLIERS "C" JAW

STANLEY
FATMAX



- Easy release - when the TRULOCK is disengaged the squeeze to release
- Security - no accidental release due to TRULOCK
- Eyebolts for higher torque tightening and faster winding
- Firm grip - optimised jaw and tooth geometry design
- New rust resistant black finish on high-performance steel for a longer life
- Induction hardened CR-V Jaws for long-life

CODE	DESCRIPTION				PRICE
FMHT0-75408	FATMAX Grip Pliers "C" Jaw 150 mm	X	4		
FMHT0-74892	FATMAX Grip Pliers "C" Jaw 280 mm	-	2		

SPECIFIC PLIERS

FATMAX® AUTOMATIC WIRE STRIPPER

STANLEY
FATMAX



- Automatically adjustable wire stripper
- Suitable for stripping copper and aluminum wire up to 10 mm² (multiple wire) and up to 6 mm² (single wire)
- Ergonomic non-slip handle

CODE	DESCRIPTION				PRICE
FMHT0-96230	FATMAX Automatic Wire Stripper	-	6		

CRIMPING PLIER 220 MM - DIPPED HANDLE

- Crimping: 1.5 / 2.5 / 6 mm²
- Wire stripper: 0.75 - 6 mm²
- Bolt cutter
- Black finish
- Ergonomic handle
- Fast and smooth use



CODE	DESCRIPTION				PRICE
STHT0-75414	Crimping plier 220 mm	-	2		

STUD CRIMPING TOOL 260 MM

- Connects metal profiles without screws or nails



CODE	DESCRIPTION				PRICE
1-69-100	Stud crimping tool 260 mm	-	1		

FATMAX® RUSSIAN END NIPPERS

STANLEY
FATMAX



- Accurate cutting surfaces
- Long service life of the cutting edges due to high-frequency treatment up to 60 HRC
- Ergonomic handles, rounded for easy handling
- Pivot point close to the cutting edge for optimum transmission with minimal effort
- Cutting capacity: up to 4.5 mm at 80 kg/mm² and up to 1.6 mm at 160 kg/mm²

CODE	DESCRIPTION				PRICE
4-95-098*	FATMAX Russian end nippers 250 mm	X	2		
4-95-100*	FATMAX Russian end nippers 300 mm	X	2		

*Not in the Nordic assortment - special order required. Minimum order quantity applied.

RUSSIAN END NIPPERS



- High alloy steel
- Induction hardened cutting edges
- Complies with ISO 9242 - DIN 5242 standards
- Blank finished surfaces of the clamps with chemically blackened and lacquered handle for protection
- Very common in concrete work for twisting and cutting tie wires on reinforcement bars or rebars

CODE	DESCRIPTION				PRICE
1-84-182*	Russian End nippers 280 mm	-	6		

*Not in the Nordic assortment - special order required. Minimum order quantity applied.

END NIPPERS - DIPPED HANDLE



- High alloy steel
- Induction hardened cutting edges
- Complies with ISO 9242- DIN 5242 standards
- Blank finished surfaces of the clamps with chemically blackened and handle with yellow plastic cover for protection
- Very common in concrete work for twisting and cutting tie wires on reinforcement bars or rebars

CODE	DESCRIPTION				PRICE
2-84-208	End nippers plastic 250 mm	X	6		

CARPENTER'S PINCERS



- High alloy steel with precision broached jaws and cutting edges
- Flat handle for comfortable use
- Complies with ISO 9243 and DIN 5241 standards
- Black lacquered polished head for long life

CODE	DESCRIPTION				PRICE
2-84-183	Carpenter's Pincers 180 mm	X	6		
2-84-184	Carpenter's Pincers 225 mm	X	6		
2-84-185*	Carpenter's Pincers 250 mm	X	6		

*Not in the Nordic assortment - special order required. Minimum order quantity applied.

HOLE PUNCH PLIERS



- Hole punch: 2-3, 3-3, 5-4, 5-5
- Durable chrome finishing
- Ergonomic handle
- Locking trigger for safety

CODE	DESCRIPTION				PRICE
STHT0-75044	Hole Punch Pliers	X	15		

AVIATION SNIPS

FATMAX® ERGO AVIATION SNIPS - 250 MM - LEFT CUTTING

STANLEY
FATMAX



- Improved Pivot Bolt Design for increased durability - low profile
- Precision Cut Blade Markings for precise cuts
- Slim / Flush Hardware Allows for quick and easy access in and out of the work pouch/holster
- US ERGO Certified Handle
- Improved Latch Design for quick, one-handed opening/closing
- Cutting capacity: 18swg/1.2mm plain steel, 22swg/0.8mm stainless steel

CODE	DESCRIPTION				PRICE
FMHT73755-0	FATMAX Ergo Aviation Snips - 250mm Left Cutting	X	4		

FATMAX® ERGO AVIATION SNIPS - 250 MM - STRAIGHT CUTTING

STANLEY
FATMAX



- Improved Pivot Bolt Design for increased durability - low profile
- Precision Cut Blade Markings for precise cuts
- Slim / Flush Hardware Allows for quick and easy access in and out of the work pouch/holster
- US ERGO Certified Handle
- Improved Latch Design for quick, one-handed opening/closing
- Cutting capacity: 18swg/1.2mm plain steel, 22swg/0.8mm stainless steel

CODE	DESCRIPTION				PRICE
FMHT73756-0	FATMAX Ergo Aviation Snips - 250 mm Straight Cutting	X	4		

FATMAX® ERGO AVIATION SNIPS - 250 MM - RIGHT CUTTING

STANLEY
FATMAX



- Improved Pivot Bolt Design for increased durability - low profile
- Precision Cut Blade Markings for precise cuts
- Slim / Flush Hardware Allows for quick and easy access in and out of the work pouch/holster
- US ERGO Certified Handle
- Improved Latch Design for quick, one-handed opening/closing
- Cutting capacity: 18swg/1.2mm plain steel, 22swg/0.8mm stainless steel

CODE	DESCRIPTION				PRICE
FMHT73557-0	FATMAX Ergo Aviation Snips - 250mm Right Cutting	X	4		

STANLEY® FATMAX® AVIATION SNIPS STRAIGHT CUT COMPOUND ACTION

STANLEY
FATMAX



- Excellent for cutting aluminium, vinyl siding, screening, cardboard, leather and copper
- Exceeds ANSI standards for cutting performance and durability
- High leverage, compound cutting design cuts up to 18 gauge steel
- Made from forged alloy steel for strength and durability
- Patented hinge plate for easy product function identification
- Permanent identification plate for the direction of cutting
- Serated cutting edges prevent slippage when cutting
- Twin spiral spring for increased longevity

CODE	DESCRIPTION				PRICE
2-14-563	FATMAX Tin Scissors Narrow Beak Straight	X	6		

FATMAX® AVIATION SNIPS COMPOUND ACTION - LEFT & RIGHT CUT

STANLEY
FATMAX



- Excellent for cutting aluminium, vinyl siding, screening, cardboard, leather and copper
- Exceeds ANSI standards for cutting performance and durability
- High leverage, compound cutting design cuts up to 18 gauge steel
- Made from forged alloy steel for strength and durability
- Patented hinge plate for easy product function identification
- Permanent identification plate for the direction of cutting
- Serated cutting edges prevent slippage when cutting
- Twin spiral spring for increased longevity

CODE	DESCRIPTION				PRICE
2-14-562	FATMAX Aviation Snips Compound action - Left	X	6		
2-14-564	FATMAX Aviation Snips Compound action - Right	X	6		

STANLEY® FATMAX® MAXSTEEL™ AVIATION SNIPS

STANLEY
FATMAX



- Bi-material easy grip handles
- Double pivot action for high cutting power
- Cuts up to 18 gauge mild steel 0.7 to 1.2mm
- Also suitable for cutting aluminum, UPVC sheet, wire mesh, leather, copper and plastic
- One handed automatic latch release
- Made from forged alloy steel for strength and durability
- Meets or exceeds ANSI standards
- Serated cutting edges prevent slippage when cutting

CODE	DESCRIPTION				PRICE
2-14-567	FATMAX® MaxSteel™ Aviation Snips Left	X	6		
2-14-568	FATMAX® MaxSteel™ Aviation Snips Right	X	6		

BOLT CUTTERS

BOLT CUTTERS - TUBULAR HANDLES

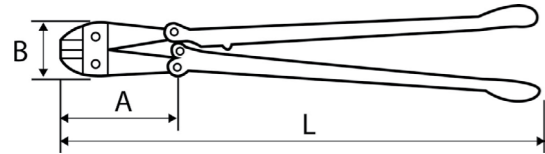

- Strong & durable material: forged molybdenum steel
- Maximum cutting capacity: 10 mm at 160 kg/mm²
- GSA AA-3047 compliant
- Ergonomic handles
- Adjustable jaws (sold separately)
- Supplied with technical info card

CODE	DESCRIPTION				PRICE
1-17-750*	Bolt cutters 350 mm / 14" tubular handles	-	1		
1-17-751*	Bolt cutters 450 mm / 18" tubular handles	-	1		
1-17-752*	Bolt cutters 600 mm / 24" tubular handles	-	1		
1-17-753*	Bolt cutters 750 mm / 30" tubular handles	-	1		
1-17-754*	Bolt cutters 900 mm / 36" tubular handles	-	1		
1-17-755*	Bolt cutters 1050 mm / 42" tubular handles	-	1		

*Not in the Nordic assortment - special order required. Minimum order quantity applied.

BOLT CUTTERS - FORGED HANDLES

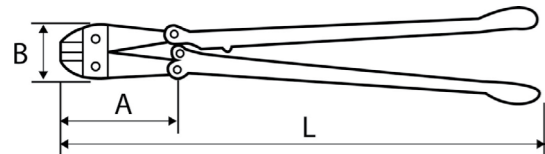

- Strong & durable material: forged molybdenum steel
- Maximum cutting capacity: 10 mm at 160 kg/mm²
- GSA AA-3047 compliant
- Ergonomic handles
- Adjustable jaws (sold separately)
- Supplied with technical info card

CODE	DESCRIPTION				PRICE
1-95-564	Bolt cutters 450mm / 18" forged handles	-	1		
1-95-565	Bolt cutters 600mm / 24" forged handles	-	1		
1-95-566	Bolt cutters 750 mm / 30" forged handles	-	1		
1-95-567	Bolt cutters 900 mm / 36" forged handles	-	1		

REPLACEMENT JAWS FOR BOLT CUTTERS



CODE	DESCRIPTION				PRICE
1-17-756*	Replacement jaws for 1-17-750 (350mm)	-	1		
1-17-757*	Spare jaws for 1-17-151 and 1-95-564 (450m)	-	1		
1-17-758*	Spare jaws for 1-17-152 and 1-95-565 (600mm)	-	1		
1-17-759*	Spare jaws for 1-17-753 and 1-95-566 (750mm)	-	1		
1-17-760*	Spare jaws for 1-17-754 and 1-95-567 (900mm)	-	1		
1-95-569*	Spare jaws for 1-17-755 (1050mm)	-	1		

*Not in the Nordic assortment - special order required. Minimum order quantity applied.

THE MEASURE OF A PRO™



FASTENING TOOLS

Ease of use is rule number one in fastening. STANLEY® fastening tools are filled with features that make them a snap to operate. Our staple guns have easy-to-squeeze triggers and comfortable handles to reduce hand fatigue. Our tackers feature shock-absorbing handles. Our glue guns are trigger fed. And we lengthened the handles on our riveters so they'd require less force to engage. We even made selecting and storing fasteners hassle-free with color-coded packaging for accurate identification in the store and water-resistant cases for durability on the work site.



PRACTICAL INFO

CHOOSE THE RIGHT STAPLER AND TACKER



MANUAL STAPLE GUN

Top performance for most fastening applications

- Shoot a variety of staple sizes and formats, including cable staples and brads
- Fast and accurate fastening in most applications

- **TIP 1:** Choose the best staple type for the job. If you want to remove it later select the shortest that is suitable, if it is to be permanent select a longer staple. Set the power to hi or lo setting and test on a scrap piece.
- **TIP 2:** If the staples are to be visible it is good practice to try to keep them in alignment and an equal distance apart – for accurate spacing it's a good idea to make a gauge.
- **TIP 3:** If you are stapling fragile materials that have a distinct structure like wood veneer, always position the staple across the grain for greater strength. With some thin materials, even on low power, the staple may tend to cut through and become ineffective. Change to a broad crown staple or add a piece of stronger material between the staple crown and the work piece.
- **TIP 4:** When work is completed fire off one final staple and hold the handle in the closed position and place the wire loop over the plastic hook on the handle to hold the handle in the closed position for storage.

HAMMER TACKER

For heavy duty applications and fast stapling

- Fixing sheet materials such as insulation and waterproof membranes to wood
Ideal for flooring, roofing and pallet labelling

ELECTRICAL STAPLE GUN

Ideal for heavy duty applications in MDF and Plywood. Electric staples provide constant firing power.

- Renovation & woodworking
- Installation and repair of fences

STAPLE GUNS

6-TR35 JUNIOR STAPLE GUN



- Compact & light with plastic housing
- "Easy Squeeze" mechanism - for 25% easier use
- Staple re-load window allows you to re-load staples when needed
- Anti-blocking function
- Integrated gauge for precise alignment of the tacker to the material
- Suitable for type A staples: 6, 8 and 10 mm

CODE	DESCRIPTION				PRICE
6-TR35	6-TR35 Junior Staple gun	X	6		



6-TR40 STAPLE GUN



- Easy to operate
- Staple re-load window allows you to re-load staples when needed
- Easy to load
- Built-in staple remover
- Small and compact - convenient to store
- Suitable for type A staples: 6, 8 and 10 mm

CODE	DESCRIPTION				PRICE
6-TR40	6-TR45 Staple gun	X	6		



6-TR45 BASIC STAPLE GUN



- For occasional hobby use
- Robust steel design
- Easy and fast loading
- Lock down handle for easier storage
- Suitable for type A staples: 6, 8 and 10 mm

CODE	DESCRIPTION				PRICE
6-TR45	6-TR45 Basic Staple gun	X	4		



6-TR150L LIGHT STAPLE GUN FOR STAPLES AND NAILS



- For general applications
- Versatile deployment options
- Robust aluminum housing
- Light weight, high load capacity
- Lock down handle- for easy and compacy storage
- Easy and fast loading
- Suitable for type A staples: 6, 8, 10, 12 and 14 mm
- Suitable for type J nails: 12 and 15 mm

CODE	DESCRIPTION				PRICE
6-TR150L	6-TR150L Light Staple gun for stapling and nails	X	6	3 2 5 3 5 6 6 1 0 6 0 5 1 4	



6-TR110 STAPLE GUN SHARP SHOOTER



- Robust steel construction
- Staple re-load window allows you to re-load staples when needed
- Easy to load
- Lock down handle- for easy and compacy storage
- Suitable for type G staples: 6, 8, 10, 12 and 14 mm - heavy duty applications

CODE	DESCRIPTION				PRICE
6-TR110	6-TR110 Staple gun Sharp Shooter	X	6	3 2 5 3 5 6 6 1 0 5 5 5 7 2	



6-TR120 LIGHT STAPLE GUN 3 IN 1



- Staple re-load window allows you to re-load staples when needed
- Anti-blocking function
- Easy and fast loading
- Lockable
- Ergonomic handle
- Suitable for type A staples: 6, 8 and 10 mm
- Suitable for type H staples: 6, 8 and 10 mm
- Suitable for type J nails: 10 mm
- Supplied with staples: 500x staples type A 10 mm

CODE	DESCRIPTION				PRICE
STHT6-70410	6-TR120 Light Staple gun 3in1	X	5	3 2 5 3 5 6 6 1 7 0 4 1 0 4	



6-TR150HL HEAVY DUTY STAPLE GUN



- For general applications
- Light weight, high load capacity
- Height/depth adjustment
- Lock down handle- for easy and compacy storage
- Easy and fast loading
- Robust aluminum housing
- Suitable for type G staples: 6, 8, 10, 12 and 14 mm - heavy duty applications

CODE	DESCRIPTION				PRICE
6-TR150HL	6-TR150HL Heavy Duty Staple gun	X	6	3 2 5 3 5 6 6 1 0 5 8 4 2 9	



FATMAX® 6-TR400 STAPLE GUN 4 IN 1

STANLEY
FATMAX



- Plastic housing with metal magazine
- Easy and fast loading - bottom Loading
- Ergonomic handle and staple indicator
- Suitable for type A staples: 6, 8, 10, 12 and 14 mm
- Suitable for type 7 staples: 10, 11, 12 and 14 mm
- Suitable for type J nails: 15 mm
- Supplied with starter pack of staples, nails & staples

CODE	DESCRIPTION				PRICE
FMHT6-70411	FATMAX 6-TR400 Light Staple gun 4in1	X	5	3 2 5 3 5 6 6 1 7 0 4 1 1 1	



6-CT-10X STAPLE GUN FOR CABLES AND WIRING



- Fixing cables and wiring
- Robust aircraft aluminum cast housing combines lightweight handling with lasting durability
- Easy and fast loading
- Lock down handle- for easy and compacy storage
- Suitable for type 7 staples: 10, 11, 12 and 14 mm
- Suitable for type CT300 staples: 8, 10 and 12 mm

CODE	DESCRIPTION				PRICE
6-CT-10X	6-CT-10X Staple gun for power lines	X	6	3 2 5 3 5 6 6 1 0 5 1 1 0 9	



FATMAX® STAPLE GUN REVERSE SQUEEZE

STANLEY
FATMAX



- Reverse Squeeze: By applying the force of the handle straight above the workarea
- Ergonomic trigger: 25% easier to use
- Refill from the bottom: easy to refill staples and nails
- Staple indicator: visibility when refilling is required
- Nylon composite housing
- For ultimate lightweight durability
- Suitable for G staples: 6, 8, 10, 12 and 14 mm
- Suitable for type J nails: 12 and 15 mm

CODE	DESCRIPTION				PRICE
FMHT0-80551	FATMAX Staple gun Reverse Squeeze	-	4	3 253560 805517	



0-TR250 HEAVY DUTY STAPLE GUN FOR STAPLES AND NAILS



- For general applications
- With versatile application options
- Height/depth adjustment
- Light weight, high load capacity
- Easy and fast loading
- Lock down handle- for easy and compacy storage
- Professional quality
- Robust aluminum housing
- Suitable for type G staples: 6, 8, 10, 12 and 14 mm - heavy duty applications
- Suitable for type J nails: 12 and 15 mm

CODE	DESCRIPTION				PRICE
STHT72674-9	0-TR250 Heavy Duty Staple gun + 3000pcs G-staples 10mm	blister	6	3253569726745	
0-TR250*	0-TR250 Heavy Duty Staple gun for staples and nails	X	6	3 253560 050078	

*Not in the Nordic assortment - special order required. Minimum order quantity applied.



FATMAX® 6-TR350 HEAVY DUTY STAPLE GUN 2 IN 1

STANLEY
FATMAX



- Light weight die cast
- Soft grip handle for extra comfort
- Anti-blocking function
- Lockable
- Easiest to squeeze
- Suitable for type G staples: 6, 8, 10, 12 and 14 mm - heavy duty applications
- Suitable for type J nails: 12 and 15 mm

CODE	DESCRIPTION				PRICE
6-TR350	FATMAX 6-TR350 Heavy Duty Staple gun 2in1	-	4	3 253566 704135	



FATMAX® 6-TR75 STAPLE GUN 6-IN-1

STANLEY
FATMAX



- Suitable for 6 types of staples/nails
- Easy and fast loading
- Anti-blocking function
- Staple Indicator allows visibility of when reload is needed
- Height/depth adjustment
- Suitable for type A and G staples: 6, 8, 10, 12 and 14 mm - light and heavy duty applications
- Suitable for type H staples: 6, 8 and 10 mm
- Suitable for type 7 staples: 12 and 14 mm
- Suitable for type J nails: 15 mm
- Supplied with starter pack of nails and staples

CODE	DESCRIPTION				PRICE
FMHT6-70868	FATMAX 6-TR75 Staple gun 6in1	-	5	3 253566 708683	



FATMAX® STAPLE GUN 4-IN-1

STANLEY
FATMAX



- Lightweight
- Nylon composite housing for ultimate durability
- "Easy Squeeze" mechanism - for 25% easier use
- Comfortable grip
- Refill from the bottom: easy refilling of staples
- Reversible belt clip
- Staple Indicator allows visibility of when reload is needed
- Suitable for type A staples: 6, 8, 10, 12 and 14 mm
- Suitable for type G staples: 6, 8, 10, 12 and 14 mm
- Suitable for type 7 staples: 12 and 14 mm
- Suitable for type J nails: 15mm 18G

CODE	DESCRIPTION				PRICE
FMHT0-80550	FATMAX 4in1 Tacker	X	4	3 253560 805500	



FATMAX® LIGHTWEIGHT 3-STICK HAMMER TACKER + 1000 STAPLES

STANLEY
FATMAX



- Reliable and easy to use thanks to the Auto-Lock / Anti Jam technology
- Lightweight Nylon-Composite housing for better durability
- Comfortable grip
- Refill from the bottom: easy refilling of staples
- Suitable for type G staples: 8-12 mm
- Supplied with 1000 G staples: 10 mm

CODE	DESCRIPTION				PRICE
FMHT81394-9	FATMAX 3 Stick Lightweight Hammer Tacker + 1000 staples	X	4	3 253560 813949	



6-PHT150 HAMMER TACKER



- For fast installation of carpeting, roofing materials or insulation
- Robust steel housing
- Fits 2 sticks of staples to reduce re-load times
- Ergonomic handle
- Easy and fast loading
- Suitable for type G staples: 6, 8 and 10 mm

CODE	DESCRIPTION	✉	✕	📊	PRICE
6-PHT150	6-PHT150 Hammer tacker	X	6	3 253566 051505	



6-TRE550 ELECTRIC STAPLE GUN



- For general applications
- Suitable for corner applications
- Ergonomic handle
- Easy and fast loading
- Cable length: 2.4m
- Suitable for type G staples: 6, 8, 10, 12 and 14 mm
- Suitable for type J nails: 12 and 15 mm

CODE	DESCRIPTION	✉	✕	📊	PRICE
6-TRE550	6-TRE550 Electric Staple gun	X	2	3 253566 058580	

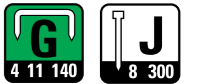

FATMAX® ELECTRIC STAPLE GUN 5-IN-1

STANLEY
FATMAX



- Ergonomic handle
- Integrated Wire Guide: Ensures that the legs of the staples go around the wire, not through it
- Staples are refilled from the bottom: makes refilling and clearing easy
- Multitacking: suitable for most professional fastening applications
- Suitable for type G staples: 6, 8, 10, 12 and 14 mm - heavy duty applications
- Suitable for type 7 Staples: 10, 11, 12 and 14 mm
- Suitable for type CT300 staples: 8, 10 and 12 mm
- Suitable for type J nails: 12 and 15 mm

CODE	DESCRIPTION	✉	✕	📊	PRICE
FMHT6-75934	FATMAX Electric Staple gun 5in1	-	4	3 253566 759340	



6-TRE650 ELECTRIC NAIL GUN



- Hi/Lo adjustment for wide range of applications
- Safety button
- Non-marring tips helps prevent damage
- Soft handle
- Easy to load - anti-lock mechanism and Staple re-load window allows you to re-load staples when needed
- Wire 2.4m long
- Suitable for type J nails: 15, 20, 25, 30 and 32 mm

CODE	DESCRIPTION	✉	✕	📊	PRICE
6-TRE650*	6-TRE650 Electric Nail Gun	X	2	3 253566 055855	

*Not in the Nordic assortment - special order required. Minimum order quantity applied.



6-TRE540 ELECTRIC STAPLE GUN 2-IN-1



- Safety switch
- Suitable for type A staples: 6, 8, 10, 12 and 14 mm
- Suitable for type J nails: 12 and 15 mm

CODE	DESCRIPTION	✉	✕	📊	PRICE
STHT6-70414	6-TRE540 Electric Staple gun 2in1	-	5	3 253566 704142	





PRACTICAL INFO

CHOOSE THE RIGHT STAPLES



LIGHT DUTY STAPLES

TYPE 3 / 53 / 530



Furniture Upholstery, Vinyl, and trim, Picture frames, Automotive upholstery, Labeling

- Paper / Carton
- Fabrics

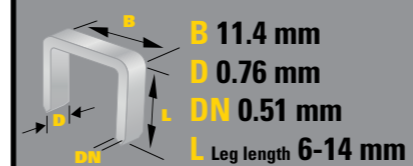

LIGHT, FINE DUTY STAPLES

TYPE 13 / 15 / 19



Furniture, Pallet, Crate, Sheathing, Subflooring, Packaging

- Paper / Carton
- Fabrics

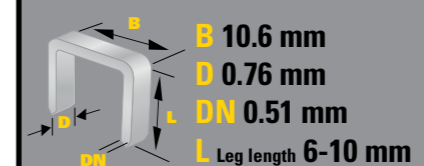

HEAVY DUTY STAPLES

TYPE 4 / 11 / 140



Furniture framework, Roof shingles, House manufacturing, Packaging

- Garden
- Roofing
- Isolating
- Carpeting
- Upholstery

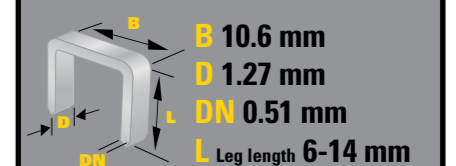



CT100

ROUND CROWN STAPLE

TYPE CT100



Round cables:
network, speaker, etc.



Cables

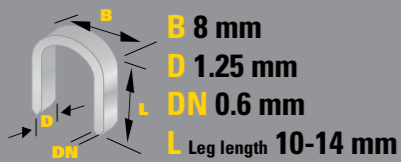

CT 300

FLAT CROWN STAPLE

TYPE CT300



Flat cables:
low voltage, etc.



Cables

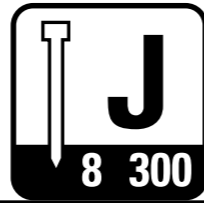
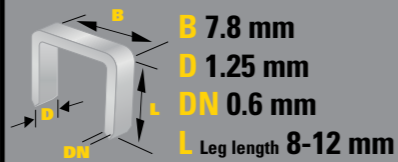

8 300

NAILS

TYPE 8 / 300



Woodworking:
baseboards, door jambs,
etc.



Woodworking

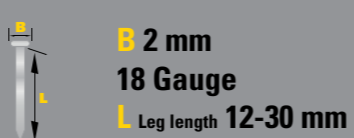

STAPLES TYPE A



- Crown width 11.4 mm
- Wire Width 0.76mm
- Wire thickness 0.51mm
- galvanized

CODE	DESCRIPTION	✉	✕	📦	PRICE
1-TRA204-5T	Staples 6 mm Type A - 5000 pcs	X	6	3 2 5 3 5 6 1 1 0 5 8 7 2 1	
1-TRA205-5T*	Staples 8 mm Type A - 5000 pcs	X	6	3 2 5 3 5 6 1 1 0 5 8 7 3 8	
1-TRA206-5T	Staples 10 mm Type A - 5000 pcs	X	6	3 2 5 3 5 6 1 1 0 5 8 7 4 5	
1-TRA202T	Staples 4 mm Type A - 1000 pcs	X	7	3 2 5 3 5 6 1 1 0 5 5 0 9 6	
1-TRA204T	Staples 6 mm Type A - 1000 pcs	X	7	3 2 5 3 5 6 1 1 0 5 3 8 8 7	
1-TRA205T	Staples 8 mm Type A - 1000 pcs	X	6	3 2 5 3 5 6 1 1 0 5 3 8 9 4	
1-TRA206T	Staples 10 mm Type A - 1000 pcs	X	5	3 2 5 3 5 6 1 1 0 5 4 1 0 5	
1-TRA208T	Staples 12 mm Type A - 1000 pcs	X	4	3 2 5 3 5 6 1 1 0 5 5 1 4 0	
1-TRA209T	Staples 14 mm Type A - 1000 pcs	X	4	3 2 5 3 5 6 1 1 0 5 5 1 9 5	

*Not in the Nordic assortment - special order required. Minimum order quantity applied.

STAPLES TYPE G

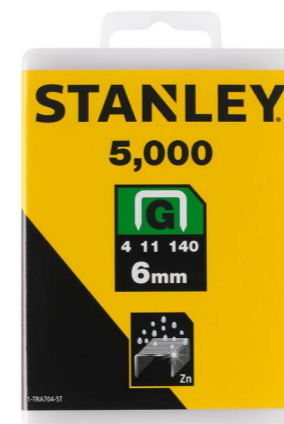

- Crown width 10.6 mm
- Wire width 1.27mm
- Wire thickness 0.51mm
- galvanized

CODE	DESCRIPTION	✉	✕	📦	PRICE
1-TRA704-5T	Staples 6 mm Type G - 5000 pcs	X	6	3 2 5 3 5 6 1 1 0 5 2 6 7 5	
1-TRA705-5T	Staples 8 mm Type G - 5000 pcs	X	6	3 2 5 3 5 6 1 1 0 5 8 2 6 4	
1-TRA706-5T	Staples 10 mm Type G - 5000 pcs	X	6	3 2 5 3 5 6 1 1 0 5 0 6 5 7	
1-TRA708-5T	Staples 12 mm Type G - 5000 pcs	X	6	3 2 5 3 5 6 1 1 0 5 0 8 5 5	
1-TRA709-5T	Staples 14 mm Type G - 5000 pcs	X	6	3 2 5 3 5 6 1 1 0 5 8 2 7 1	
1-TRA704T	Staples 6 mm Type G - 1000 pcs	X	7	3 2 5 3 5 6 1 1 0 5 4 1 9 8	
1-TRA705T	Staples 8 mm Type G - 1000 pcs	X	6	3 2 5 3 5 6 1 1 0 5 4 2 7 3	
1-TRA706T	Staples 10 mm Type G - 1000 pcs	X	5	3 2 5 3 5 6 1 1 0 5 4 2 8 0	
1-TRA708T	Staples 12 mm Type G - 1000 pcs	X	4	3 2 5 3 5 6 1 1 0 5 4 2 9 7	
1-TRA709T	Staples 14 mm Type G - 1000 pcs	X	4	3 2 5 3 5 6 1 1 0 5 4 3 0 3	
STHT74749-0*	Staple mix 6, 10 and 12mm Type G - 2000 pieces	X	4	3 2 5 3 5 6 0 1 7 4 7 4 9 7	

*Not in the Nordic assortment - special order required. Minimum order quantity applied.

STAPLES TYPE H



- Crown width 10.6 mm
- Wire width 0.76mm
- Wire thickness 0.51mm
- galvanized

CODE	DESCRIPTION	☐	☒	☐	PRICE
1-TRR134T	Staples 6 mm Type H - 1000 pcs	X	7	3 2535611060243	
1-TRR135T	Staples 8 mm Type H - 1000 pcs	X	6	3 2535611060250	
1-TRR136T	Staples 10 mm Type H - 1000 pcs	X	5	3 2535611060267	

STAPLES TYPE 7



- Crown width 8 mm
- Wire width 1.25mm
- Wire thickness 0.60mm
- galvanized

BOLT CUTTERS

CODE	DESCRIPTION	☐	☒	☐	PRICE
1-CT106T	Staples 10 mm Type 7 - 1000 pcs	X	6	3 2535611058479	
1-CT107T*	Staples 11 mm Type 7 - 1000 pcs	X	6	3 2535611058486	
1-CT108T	Staples 12 mm Type 7 - 1000 pcs	X	4	3 2535611058493	
1-CT109T	Staples 14 mm Type 7 - 1000 pcs	X	4	3 2535611051692	

*Not in the Nordic assortment - special order required. Minimum order quantity applied.

STAPLES TYPE CT



- galvanized

CODE	DESCRIPTION	☐	☒	☐	PRICE
1-CT305T	Staples 8 mm Type CT - 1000 pcs	X	6	3 2535611058561	
1-CT306T	Staples 10 mm Type CT - 1000 pcs	X	5	3 2535611058592	
1-CT308T	Staples 12 mm Type CT - 1000 pcs	X	4	3 2535611058608	

NAILS TYPE J



- galvanized

CODE	DESCRIPTION	☐	☒	☐	PRICE
1-SWK-BN050T	Nails 12 mm - 1000 pcs	X	10	3 2535611051746	
1-SWK-BN0625T	Nails 15 mm - 1000 pcs	X	10	3 2535611058370	
1-SWKBN075T*	Nails 20 mm Type J - 1000 pcs	X	10	3 2535611051760	
1-SWKBN100T	Nails 25 mm Type J - 1000 pcs	X	10	3 2535611058394	
1-SWKBN1187T*	Nails 30 mm Type J - 1000 pcs	X	10	3 2535611051777	
STHT70500-0*	Nails 32 mm Type J - 1000 pcs	X	10	3 2535601705008	

*Not in the Nordic assortment - special order required. Minimum order quantity applied.

RIVETERS

6-MR100 CONTRACTOR GRADE RIVETER



- 4 nose pieces & wrench store in handle for versatility and convenient storage
- Accepts aluminium, steel & stainless steel rivets for wide range of applications

· **Contract grade - heavy duty, long lasting**

CODE	DESCRIPTION	☐	☒	☐	PRICE
6-MR100	Contractor Grade Riveter MR100	X	4	3 2535661053004	

6-MR77 SWIVEL HEAD RIVETER



- Head rotates 360° for use at any angle
- Long handles make riveters easy to squeeze
- 4 nose pieces & wrench store in handle for versatility and convenient storage

· **Rugged die-cast metal construction for long life**

CODE	DESCRIPTION	☐	☒	☐	PRICE
6-MR77	Swivel Head Riveter MR77	X	5	3 2535661052427	

6-MR55 RIGHT ANGLE RIVETER



- 4 nose pieces & wrench store in handle for versatility and convenient storage
- Long handles make riveters easy to squeeze
- Rugged steel construction for long-lasting durability

· **Extra nozzle**

CODE	DESCRIPTION	☐	☒	☐	PRICE
6-MR55	Right Angle Riveter MR55	X	5	3 2535661051550	

MR55 HEAVY DUTY RIVETER



- Heavy duty riveter with spring loaded handle
- 4 interchangeable nozzles: diameters 2-3-4-5
- Ejection of the rivet shank
- Nose at 90°
- Nozzle spanner included

CODE	DESCRIPTION	☐	☒	☐	PRICE
0-69-804	MR55 RIVETER H/DUTY (CLAM)	X	5	3253560698041	

MR33 MEDIUM DUTY RIVETER



- Three mm and four mm fixed rivets
- Long handle makes riveter easy to squeeze

CODE	DESCRIPTION	☐	☒	☐	PRICE
0-69-833	MR33 Medium Duty Riveter	X	5	3253560698331	

ALUMINIUM RIVETS



CODE	DESCRIPTION				PRICE
1-PAA42T	Aluminium rivets 3 × 3mm	X	10		
1-PAA44T	Aluminium rivets 3 × 7mm	X	10		
1-PAA48T	Aluminium rivets 3 × 12mm	X	10		
1-PAA52T	Aluminium rivets 4 × 3mm	X	10		
1-PAA54T	Aluminium rivets 4 × 7mm	X	10		
1-PAA58T	Aluminium rivets 4 × 12mm	X	10		
1-PAA62T	Aluminium rivets 5 × 3mm	X	10		
1-PAA64T	Aluminium rivets 5 × 7mm	X	10		
1-PAA66T	Aluminium rivets 5 × 9mm	X	10		

GLUE GUNS

6-GR15 MINI GLUE GUN



- Ideal for hobby use and repair work
- Handy temperature selection button
- Suitable for mini glue sticks
- Fold-out support
- Only suitable for 1-GS10DT glue sticks

CODE	DESCRIPTION				PRICE
6-GR15	Mini Glue Gun GR15	X	4		

6-GR25 GLUE GUN



- Suitable for high and low temperature bonding applications
- Handy temperature selection button
- Suitable for standard glue sticks
- Heats up quickly and glues within 60 seconds
- Fold-out support

CODE	DESCRIPTION				PRICE
6-GR25	Glue gun GR25	X	4		

6-GR50 FAST GLUE GUN



- Short warm-up time: 1 min. 40 sec.
- Ceramic heater
- Electronic temperature control switch
- 90 to 150 W both during heating and gluing
- Headpiece included
- Glue consumption: 450gr/h
- Fold-out support

CODE	DESCRIPTION				PRICE
STHT6-70417	6-GR50 Fast Glue Gun	X	5		

6-GR90R CORDLESS GLUE GUN



- Suitable for all glue sticks
- Up to 12 minutes of wireless operation
- 25 W
- Interchangeable nozzle
- Temperature range: 180°-210°
- Glue consumption: 720gr/h
- Fold-out support

CODE	DESCRIPTION				PRICE
STHT6-70416	6-GR90R Cordless Glue Gun	X	5	3 253566 704166	

FATMAX® 6-GR100R GLUE GUN

STANLEY
FATMAX



- Short warm-up time: 1 min.
- 100 to 200 W both during heating and gluing
- Standby mode:
 - after 30 minutes of inactivity the heating stops.
 - reheats to 190° in 30 sec when activated.
- Temperature indication by means of LED lights: red - 170°, green - 170° & ready for use
- Ceramic heater
- Glue consumption: 1100 to 1500gr/h
- Supplied with 18 glue sticks: 6x DualMelt, 6x All Applications and 6x Extra Strong

CODE	DESCRIPTION				PRICE
FMHT6-70418	FATMAX 6-GR100R Glue Gun	-	5	3 253566 704180	

DUAL MELT GLUE CARTRIDGE



- Excellent for bonding heat sensitive materials, as well as general applications
- 1-GS10DT only suitable for mini glue gun 6-GR15
- Other glue sticks suitable for all devices (except mini glue gun 6-GR15)

CODE	DESCRIPTION				PRICE
1-GS10DT	Mini glue stick 7mm x 100mm - 24 pcs	X	5	3 253561 051401	
1-GS15DT	Glue stick 11.5mm x 100mm - 6 pcs	X	5	3 253561 051494	
1-GS20DT	Glue stick 11.5mm x 100mm - 24 pcs	X	5	3 253561 051418	
1-GS25DT	Glue stick 11.5mm x 250mm - 12 pcs	X	1	3 253561 052125	

HOT MELT ALL PURPOSE STANDARD CLEAR GLUE STICKS



- All purpose standard clear glue stick
- Dual Melt
- Suitable for all devices (except mini glue gun 6-GR15)

CODE	DESCRIPTION				PRICE
STHT1-70430*	Hot melt all purpose standard clear glue sticks 11.3x101mm - 1kg	X	5	3 253561 704307	

*Not in the Nordic assortment - special order required. Minimum order quantity applied.

HOT MELT ALL PURPOSE STANDARD CLEAR GLUE STICKS



- For sticking on wood, leather, fabrics, cork, plastic materials, faience and cardboard

CODE	DESCRIPTION				PRICE
STHT1-70431	Dual Melt Glue Cartridge 11.3mm x 254mm - 1kg	X	5	3 253561 704314	
STHT1-70432	Dual Melt All Purpose Glue Cartridge 11.3mm x 254mm - 24 pcs	X	5	3 253561 704321	

SUPER STRENGTH STANDARD GLUE STICKS



CODE	DESCRIPTION				PRICE
STHT1-70438	Dual Melt Amber Super Strong Glue Cartridge 11.3mm x 101mm - 6 pcs	X	5	3 253561 704383	



PLUMBING TOOLS

STANLEY® plumbing tools feature the torque, grip, and range of motion to get you through installations and repairs from large to small and simple to complex.

TOOLS FOR PLUMBING

ADJUSTABLE PIPE CUTTER



- Versatile - Cuts pipes
- Capacity: Ø 3 - 22 mm (70-447) and Ø 3 - 30 mm (70-448)
- Adjusting wheels ensure an accurate and straight cutting result.
- Replaceable cutting wheel
- 70-448: spare wheel in handle

CODE	DESCRIPTION				PRICE
0-70-447	Adjustable Pipe Cutter (3mm - 22mm)	X	24		
0-70-448	Adjustable Pipe Cutter (3mm - 30mm)	X	6		

PLASTIC PIPE CUTTER



- High precision stainless steel blade
- Ergonomic handle for maximum power transfer
- Versatile cutter for use with various materials

CODE	DESCRIPTION				PRICE
0-70-450	Plastic Pipe Cutter 28 mm	X	24		

FIXED BASIN WRENCH



- Durable steel handle
- Long reach for easy access behind the bowl
- Fixed 1/2" BSP and 3/4" BSP ends

CODE	DESCRIPTION				PRICE
0-70-454	Fixed Basin Wrench	X	24		

ADJUSTABLE BASIN WRENCH



- For Tightening tap or 'back' nuts on basins
- Knurled hook for position grip
- Reversible direction - to tighten or/and loosen
- Long reach for easy access behind bowl
- Capacity: 13 - 38mm

CODE	DESCRIPTION				PRICE
0-70-453	Adjustable Basin Wrench	X	24		

MINI PIPE BENDER



- Die cast body for strength
- Bends 6/8/10 mm Microbore Copper
- Knurled non slip grips
- Clear markings for accurate bend angles

CODE	DESCRIPTION				PRICE
0-70-451	Mini Pipe Bender (6 - 8 - 10 mm)	X	24	2 5 3 5 6 0 7 0 4 5 1 3	

PIPE BENDER



- Durable steel arms and case hardened rollers
- Precision formers and guides for crease free bends
- Long arms for high gearing
- Vice grip are for use on workbench
- Bends 12, 15 and 22mm copper

CODE	DESCRIPTION				PRICE
0-70-452	Pipe bender (15 - 22 mm)	X	2	2 5 3 5 6 0 7 0 4 5 2 0	



THE MEASURE OF A PRO™



DRYWALL TOOLS

Install, repair, and secure walls and ceilings in any building with STANLEY® drywall tools. Trust your tools to get the job done.



STANLEY TOOLS

PANEL CARRIER



- Helps transport building boards and other flat materials with ease
- Capacity 90 kg
- Ergonomic lifting handle
- Helps transport building boards and other flat materials with ease
- One person can carry large materials with better balance and control
- Synthetic, light, resistant body that does not damage the board

CODE	DESCRIPTION				PRICE
1-93-301	Panel carrier	-	6	3 2535611 933011	

WALL BOARDS CARRIER



- Bi-Material Handle for comfort and protection
- Makes carrying drywall and other boards easier
- Sold in pairs

CODE	DESCRIPTION				PRICE
STHT1-05868	Plate carrier (2 pieces)	-	4	3 2535611 058684	

TELESCOPIC SUPPORT



- Heavy duty ribbed aluminum body stays flat and rigid
- Height adjustable from 1140 mm - 2895 mm
- Efficient clamp holds panels securely in place
- Capacity: 13 kg
- Diameter : Outside: 31 mm, Middle: 28 mm, Inside: 10 mm

CODE	DESCRIPTION				PRICE
STHT1-05932	Telescopic Support	-	2	3 2535611 059322	

METRIC T-SQUARE



- Markings in inches and eighths
- Notched head to cut a 1220 mm sheet in one swoop
- Durable blade springs straight no matter how you flex
- 2" blade to cut both sides of an outlet box without moving square

CODE	DESCRIPTION				PRICE
STHT1-05894	Metric T-Square	-	2	3 2535611 058943	

DRYWALL STRIPPER



- Two cutting blades allow the end user to cut both sides of the material at once
- Bi-Material Handle for comfort and protection
- Adjustable Cutting Depth
- Replacement blades available
- **Special dry wall stripper to cut plasterboards of 9.5 to 15 mm in thickness**

CODE	DESCRIPTION				PRICE
STHT1-16069	Drywall stripper	-	4	3 2535611 160691	

SPARE WHEEL DRYWALL STRIPPER



- Diameter: 3.8mm

CODE	DESCRIPTION				PRICE
STHT0-16131	Spare wheel for STHT1-16069	X	12	3 2535601 161316	

CIRCLE CUTTER



- Precision calibrated for accuracy
- Cut clean holes with a diameter of 25 mm - 400 mm
- Pin adjusts up and down
- Easy side to side adjustment

CODE	DESCRIPTION				PRICE
STHT1-05878	Circle cutter	-	4	3 2535611 058783	

CHAMFERING TOOL



- Stamped base reduces chatter, resulting in a smooth cut
- Allows end users to create strong well fitting joints
- To use with standard utility blades for convenience
- Quick & easy blade adjuster for versatility
- Supplied with STANLEY® Carbide spare blade

CODE	DESCRIPTION				PRICE
STHT1-05937	Chamfer tool	-	4	3 2535611 059377	

PUNCH LOCK RIVETER



- To fasten metal pieces without screws or nails
- For C-shaped pieces with max. 1.2 mm metal (2x 0.6 mm)
- Minimal hand force required thanks to the optimal power transmission
- Special, extremely strong type of steel, oil-hardened and tempered
- One-handed operation for greater ease of use

CODE	DESCRIPTION				PRICE
15-261*	connecting rod	-	1	5 000366 152615	

*Not in the Nordic assortment - special order required. Minimum order quantity applied.

STUD CRIMPER



- Ensures that metal profiles are permanently joined in a U-shape, with max. 1.2 mm metal (2x 0.6 mm)
- Minimal hand force required thanks to the optimal power transmission
- Special, extremely strong type of steel, oil-hardened and tempered
- One-handed operation for greater ease of use

CODE	DESCRIPTION				PRICE
15-273	Stud crimper	-	1	5 000366 152738	

CORNER BEAD CLINCHER



- Sets corner beads with one blow
- No nails or screws needed
- Rubber headed mallet sold separately

CODE	DESCRIPTION				PRICE
STHT1-16132	Corner bead clincher 29 mm x 29 mm	-	2	3 253561 161322	

RUBBER Mallet FOR CLINCHER



CODE	DESCRIPTION				PRICE
STHT1-57100	Rubber Hammer 650gr	-	4	3 253561 571008	

DRYWALL SCREW ADAPTER PH2



- Designed to drive screws into drywall boards to the desired depth
- Suitable for any 10mm or 8mm drill bit

CODE	DESCRIPTION				PRICE
STHT0-16137	Drywall Screw adapter PH2	X	12	3 253560 161378	

MAGNETIC BIT HOLDER



- Adapter sinks screws to the proper depth
- Steel ring protects drywall
- Magnetic tip holds screws in place
- Suitable for any 10mm or 8mm drill bit

CODE	DESCRIPTION				PRICE
STHT0-05926	Magnetic Bit Holder	X	6	3 253560 059262	

JOINTING COMPOUND MIX



- Hexagonal Rod is chuckable in a standard drill 8 or 10 mm
- Perfecting for mixing compound, paint and other materials
- Mixer has wings and a protective extension so they do not come in contact with the bucket
- Available in 2 sizes

CODE	DESCRIPTION				PRICE
STHT2-28042*	Jointing Compound Mix 80 mm	-	12	3 253562 280428	
STHT2-28043*	Jointing Compound Mix 100 mm	-	6	3 253562 280435	

*Not in the Nordic assortment - special order required. Minimum order quantity applied.

MUD PAN STAINLESS STEEL



- Tapered design - fits comfortably in your hand
- Durable and easy to clean - stainless steel

CODE	DESCRIPTION				PRICE
STHT0-05867*	Stainless Steel Mud Pan	-	6	3 253560 058678	

*Not in the Nordic assortment - special order required. Minimum order quantity applied.

NARROW SPREADING KNIVES



- Stainless steel blade
- Bi-material handle
- Hole in the handle for easy hanging of the tool

CODE	DESCRIPTION				PRICE
STHT0-05934	Narrow spreading knife 300 mm × 45 mm	X	4		
STHT0-05936*	Narrow spreading knife 500 mm × 45 mm	X	4		

*Not in the Nordic assortment - special order required. Minimum order quantity applied.

TAPPING KNIVES



- Smooth zinc alloy cap for durability
- Blade that tapers from handle to tip for added flexibility
- Stainless steel blade prevents rust and increases durability
- Hole in the handle for easy hanging of the tool

CODE	DESCRIPTION				PRICE
STHT0-05895	Tapping knife 200 mm	-	4		
STHT0-05776*	Tapping knife 300 mm	-	4		

*Not in the Nordic assortment - special order required. Minimum order quantity applied.

JOINT KNIVES



- Smooth zinc alloy cap for durability
- Blade tapered from handle to tip provides flexibility
- Stainless steel blade prevents rust and increases durability
- Hole in the handle for easy hanging of the tool
- Also available with a PH2 Phillips bit on the end of the handle (STHT0-28000, -28034 and -28041)

CODE	DESCRIPTION				PRICE
STHT0-05786*	Joint knife 100 mm	-	6		
STHT0-05799*	Joint knife 125 mm	-	6		
STHT0-05864*	Joint knife 150 mm	-	6		

*Not in the Nordic assortment - special order required. Minimum order quantity applied.

JOINT KNIVES WITH BIT PH2



- Smooth zinc alloy cap for durability
- Blade tapered from handle to tip provides flexibility
- Stainless steel blade prevents rust and increases durability
- Hole in the handle for easy hanging of the tool
- Also available without a PH2 Phillips bit on the end of the handle (STHT0-0578, -05799 et -05864)

CODE	DESCRIPTION				PRICE
STHT0-28000*	Joint knife with bit PH2 100 mm	-	6		
STHT0-28034	Joint knife with bit PH2 125 mm	-	6		
STHT0-28041	Joint knife with bit PH2 150 mm	-	6		

*Not in the Nordic assortment - special order required. Minimum order quantity applied.

DRYWALL TROWEL



- Smooth zinc alloy cap for durability
- Bi-material handle for comfort and protection
- Blade tapered from handle to tip provides flexibility
- Stainless steel blade prevents rust and increases durability
- Hole in the handle for easy hanging of the tool

CODE	DESCRIPTION				PRICE
STHT0-26089*	point joint knife	-	6		

*Not in the Nordic assortment - special order required. Minimum order quantity applied.

INNER CORNER TROWEL



- Blade tapered from handle to tip provides flexibility
- Stainless steel blade prevents rust and increases durability
- Bi-material handle for comfort and protection
- Hole in the handle for easy hanging of the tool

CODE	DESCRIPTION				PRICE
STHT0-05777*	Inner corner trowel	-	4		

*Not in the Nordic assortment - special order required. Minimum order quantity applied.

OUTSIDE CORNER TROWEL



- Blade tapered from handle to tip provides flexibility
- Stainless steel blade prevents rust and increases durability
- Bi-material handle for comfort and protection
- Hole in the handle for easy hanging of the tool

CODE	DESCRIPTION				PRICE
STHT0-05622*	Outside corner trowel	-	4		

*Not in the Nordic assortment - special order required. Minimum order quantity applied.

FINISHING TROWEL



- Slightly curved blade that allows the user to create perfect joints
- Strong and light instrument for easy and durable use
- Bi-material handle for added comfort and protection

CODE	DESCRIPTION				PRICE
STHT0-05900*	Finishing trowel 320 mm × 130 mm	-	6		

*Not in the Nordic assortment - special order required. Minimum order quantity applied.

FINISHING TROWEL - ROUNDED CORNERS



- Slightly curved blade that allows the user to create perfect joints
- Strong and light instrument for easy and durable use
- Bi-material handle for added comfort and protection

CODE	DESCRIPTION				PRICE
STHT0-05898*	Finishing dust - Rounded Corners 280 mm x 130 mm	-	6		
STHT0-05899*	Finishing trowel - Rounded Corners 320 mm x 130 mm	-	6		

**Not in the Nordic assortment - special order required. Minimum order quantity applied.*

HAND SANDING BLOCK



- Heavy-duty ribbed aluminum body stays flat and rigid
- Efficient clamp design to hold paper or screen firmly in place
- 230 mm x 80.4 mm block suitable for most types of sandpaper

CODE	DESCRIPTION				PRICE
STHT0-05927	Hand sanding block	-	4		

POLE ULTILTY SANDER ALUMINUM



- Heavy duty ribbed aluminium body stays flat and rigid with wooden handle. The efficient clamp design holds paper or screen firmly in place.
- Accepts most sandpapers - sandpaper size: 300 x 105 mm
- Length: 1300 mm

CODE	DESCRIPTION				PRICE
STHT0-05928	Sanding block with aluminum handle	-	4		

SANDPAPER 80G - 10 PCS



CODE	DESCRIPTION				PRICE
STHT0-05929	Sandpaper K 80 - 10 pcs - for STHT0-05928	X	12		

SANDPAPER 120G - 10 PCS



CODE	DESCRIPTION				PRICE
STHT0-05930	Sandpaper K 120 - 10 pcs - STHT0-05928	X	12		

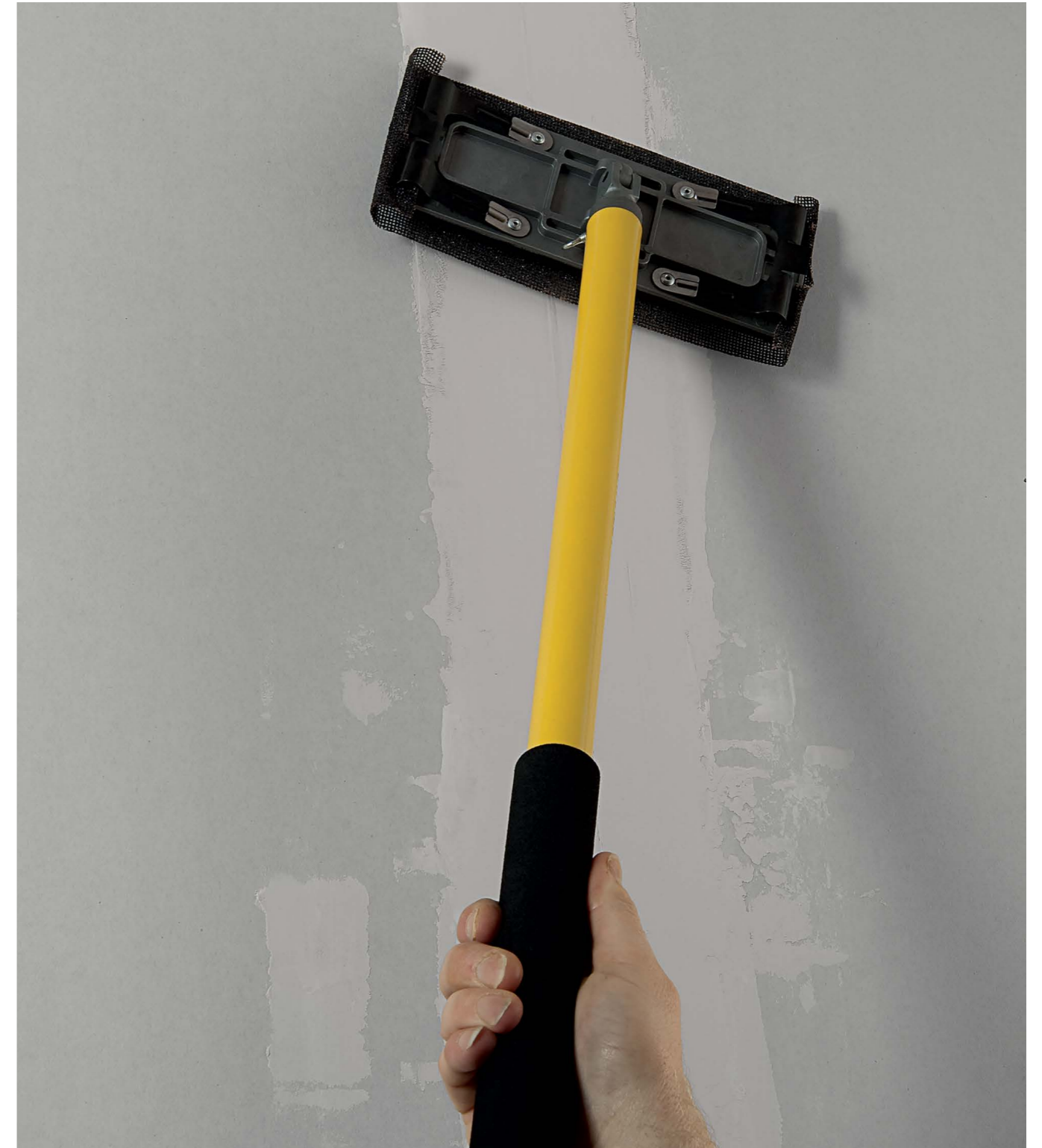

WORK LIGHTS

STANLEY® work lights and LED lamps, with or without a bluetooth connection for operation via smartphone.

WORKLIGHTS / FLASHLIGHTS

FATMAX® HEADLAMP 200LM

STANLEY
FATMAX



- Powerful LED Light
- Activation via on/off button or via the motion sensor
- Lumens: Low 50 / High 200
- Duration of use: up to 24 hours
- IP 54 dust and water resistant
- Adjustable headband
- Adjustable head
- Fits in a pocket – compact
- Supplied with 3x AAA batteries

CODE	DESCRIPTION				PRICE
FMHT81509-0	FATMAX Headlamp	X	2	3 253560 815097	

FATMAX® ALUMINUM FLASHLIGHTS

STANLEY
FATMAX



- Light intensity 70 lumens
- Shock resistant lens
- Waterproof
- Charging time 8h (only for 1-95-154)
- Battery life 2h (only for 1-95-154)
- Supplied with NiMH rechargeable battery and charger (only 1-95-154)
- 3xAAA batteries (only for 1-95-152)

CODE	DESCRIPTION				PRICE
1-95-152	FATMAX Aluminum Flashlight 3xAAA	X	6	3253561951527	
1-95-154*	FATMAX Aluminum Flashlight Rechargeable	X	6	3 253561 951541	

*Not in the Nordic assortment - special order required. Minimum order quantity applied.

FATMAX® PEN FLASHLIGHT 100LM

STANLEY
FATMAX



- Powerful LED light (COB - Chip-on-board technology)
- Lumens: 100
- Distance radius: 66 m
- Adjustable radius
- Operating time up to 10 hours
- IP 54 dust and water resistant
- Trouser clip
- Fits in a pocket – compact
- Thin and easy to shine in narrow spaces
- Supplied with 2x AAA batteries

CODE	DESCRIPTION				PRICE
FMHT81510-0*	FATMAX Pen Flashlight	X	12	3 253560 815103	

*Not in the Nordic assortment - special order required. Minimum order quantity applied.

FATMAX® FLASHLIGHT 350LM

STANLEY
FATMAX



- Powerful LED light (COB - Chip-on-board technology)
- Lumens: Low 175 / High 350
- Adjustable radius
- Distance radius: 75 - 225 m
- Operating time: 20 hours
- IP 44 dust and water resistant
- Lanyard
- Fits in a pocket – compact
- Long reach beam (75 m wide beam / 225 m narrow beam)
- Supplied with 4x AAA batteries

CODE	DESCRIPTION				PRICE
FMHT81511-0	FATMAX Flashlight 350LM	X	6		

MAXLIFE FLASHLIGHT LED TRIPOD

- Adjustable head - 3 positions
- Lumens: 20
- Integrated folding tripod
- 3 positions to turn on the flashlight
- Battery indicator
- Works with 3, 6 or 9 AA batteries (batteries not included)



CODE	DESCRIPTION				PRICE
0-95-112	Maxlife Flashlight LED Tripod*	X	6		

*Not in the Nordic assortment - special order required. Minimum order quantity applied.

FATMAX® RECHARGEABLE CONSTRUCTION WORKLIGHT 1000LM

STANLEY
FATMAX



- Compact, powerful LED Light (COB - Chip-on-board technology)
- 5 m cable
- Corded & cordless use
- Lumens: Low 500 / High 1000
- Operating time: 9 / 10 hours
- IP 67 dust and water resistant
- 180° rotating support
- Detachable 2x4 clamp with magnets
- Can be mounted on a tripod (not included)

CODE	DESCRIPTION				PRICE
FMHT81507-1	FATMAX Rechargeable Construction Spotlight 1000LM	X	4		

FATMAX® BLUETOOTH® CONSTRUCTION WORKLIGHT 3000LM

STANLEY
FATMAX



- Powerful LED Light (COB - Chip-on-board technology)
- 5 m cable
- Lumens: Low 1500 / High 3000
- IP 67 dust and water resistant
- 180° rotating support
- Detachable 2x4 clamp with magnets
- Bluetooth® connection
- 5 independent spots on the same phone
- Can be mounted on a tripod (not included)

CODE	DESCRIPTION				PRICE
FMHT81508-1*	FATMAX Bluetooth Construction spot 3000LM	X	3		

*Not in the Nordic assortment - special order required. Minimum order quantity applied.





STORAGE SOLUTIONS

The diverse STANLEY® storage box line-up includes heavy-duty toolboxes which can be customised using the foam insert, drawer units for accessories and small parts, as well as a handy caddy for small storage sets and larger storage boxes for tools.

No matter what kit you take on a job, you'll need to have your accessories to hand including all your screws, clips, connectors, cables and more. The STANLEY® organisers let you keep everything in its place with tough clear case lids for fast selection and removable storage cups for added flexibility.

A COMPLETE STORAGE RANGE

A range of possibilities

STANLEY offers a complete range of tool trolleys for the construction sites, with a capacity of 50 to 190 liters and with a frame in polypropylene and metal. All high-quality and robust storage systems, suitable for professional use.

Different storage options: toolboxes, boxes for power tools and organizers with different compartments. Large choice of sizes, colours, materials (bimaterial or not), with or without different compartments, with metal or synthetic closing hooks, etc.

Wide range of robust and easy to move trestles. Due to their polypropylene construction, these trestles have the best weight/strength ratio on the market. Large options from simple folding trestles to telescopic trestles with a high load capacity.





STANLEY MOBILE STORAGE 50L

Time saving

We understand that time-saving products are an important asset for craftsmen. That is why we designed a new tool trolley, the STANLEY® tool trolley 50L with storage compartments in the lid, a removable case for small hand tools and a lock that can be opened and closed with one hand. Everything you need is easy to find and easily accessible. Thanks to the telescopic handle and large wheels, this spacious tool trolley is also easy to move.

ROLLING WORKSHOPS

STANLEY® FATMAX® ROLLING WORKSHOP CANTILEVER - METAL/PLASTIC

STANLEY
FATMAX



- 20" Detachable metal plastic Toolbox with removable tray
- Large metal rust proof latches with padlock eye
- 2 Deep 4" drawer with ball bearing slides
- Large metal storage bin that provides extra large capacity of portable tool storage
- Heavy duty 7" wheels
- Cantilever' system for instant access to all storage area's
- Telescopic handle and large wheels
- Outer Dimensions (cm WxDxH): 56.8 x 38.9 x 89.3
- Inner Dimension (cm WxDxH) Base: 48 x 24 x 34
Drawer: 48.5 x 24 x 9.5
20" toolbox: 48 x 23 x 26

CODE	DESCRIPTION				PRICE
1-95-622	FATMAX Rolling Workshop Metall/Plastic	-	1		

STANLEY® ROLLING WORKSHOP CANTILEVER METAL/PLASTIC



- 20" Detachable metal plastic Toolbox with removable tray
- Large metal rust proof latches with padlock eye
- Deep 4" drawer with ball bearing slides
- Large metal storage bin that provides extra large capacity of portable tool storage
- Cantilever' system for instant access to all storage area's
- Telescopic handle and large wheels
- Outer Dimensions (cm WxDxH): 56.8 x 38.9 x 73
- Inner Dimension (cm WxDxH) 20" toolbox: 48 x 23 x 26
Middle toolbox/Organiser: 48.5 x 24 x 9.5
Base/Deep bin: 48 x 24 x 34

CODE	DESCRIPTION				PRICE
1-95-621	Rolling Workshop Metall/Plastic	-	1		

STANLEY® FATMAX® ROLLING WORKSHOP CANTILEVER

STANLEY
FATMAX



- 3 in 1 extendable
- Extendable handle and robust wheels
- 2 side handles
- Automatic handles extendable parts
- Easy to unlock to slide open
- Toolbox lid includes integrated V-groove for work with lumbers and pipes
- Organizer with removable dividers
- Outer Dimensions (cm WxDxH): 55 x 41.2 x 73.3
- Inner Dimension (cm WxDxH) Top toolbox: 48 x 23 x 26
Middle organiser (x4): 10 x 27 x 11
Base toolbox: 45 x 25.5 x 37.5

CODE	DESCRIPTION				PRICE
1-94-210	FATMAX Rolling Workshop	-	1		

STANLEY® ROLLING WORKSHOP MODULAR 3 IN 1



- Aluminum telescopic back handle for easy elevation; handle can be lowered for storage
- Heavy duty 7" wheels for easy on-site maneuverability
- Heavy duty ball bearing slides for the drawers- quality drawer sliding system with better gripz and locking mechanism
- On top 19" toolbox
- Portable detachable containers with handle
- Outer Dimensions (cm WxDxH): 48.8 x 34.8 x 86.5
- Inner Dimension (cm WxDxH) Toolbox: 44 x 21 x 14.5
Small drawer: 34 x 20 x 4.5
Big drawer: 32.5 x 19.5 x 11.6
Tilt bin: 36 x 20 x 33

CODE	DESCRIPTION				PRICE
1-79-206	Rolling Workshop 3in1	-	2		

STANLEY® QUICKLINK ROLLING WORKSHOP 3 IN 1



- Full tower load capacity: 45kg / 80 liters
- Wide telescopic handle for extra comfort
- Easy attachment and detachment of the modules thanks to the Auto-Lock system
- Heavy duty 7" wheels for extra durability
- Front metal latches
- Modular Rolling Workshop
- Outer dimensions (cm WxDxH): 55 x 40 x 74
- Inner dimensions (cm WxDxH) Shallow toolbox: 46 x 26 x 9.5
Deep toolbox: 46 x 26 x 20.5
Deep open bin: 45 x 26 x 35

CODE	DESCRIPTION				PRICE
STST83319-1	Quicklink Rolling Workshop 3in1	-	1		

STANLEY® MODULAR ROLLING WORKSHOP WITH TOP ORGANISER 2 IN 1



- Modularity - Pro detachable Toolbox with detachable suitcase
- Clear lid suitcase for full visibility and easy access to small parts
- Detachable tote Toolbox - time saving
- Ball bearing slides for durable drawers and smooth operation
- Maneuverability – durable 7" wheels
- Outer Dimensions (cm WxDxH): 56.7 x 38.2 x 76.4

CODE	DESCRIPTION				PRICE
STST1-79231	Modular Rolling Workshop 2in1	-	2		

STANLEY® ROLLING WORKSHOP ESSENTIAL 3 IN 1



- Three toolboxes in one: Separates into three individual Toolboxes in a matter of seconds.
- Telescopic handle
- Durable 7" wheels
- Front metal latches and padlock loop
- Outer Dimensions (cm WxDxH): 47.5 x 28.3 x 63
- Inner Dimension (cm WxDxH) Base: 38 x 22.5 x 26.5
Drawer: 42 x 21.5 x 12
Case: 41 x 23 x 19.5

CODE	DESCRIPTION				PRICE
STST1-80151	Rolling Workshop Essential 3in1	-	2		

STANLEY® ROLLING WORKSHOP



- Detachable top Toolbox unit with small parts storage on top
- Detachable mid section for small parts and accessories
- Bottom bin with large 7" wheels
- Pull handle on top allows to conveniently maneuver
- Large metal latches connecting the units
- Huge storage volume for power tools, hand tools small parts and accessories
- Removable tray for essential tools
- 1-70-326 Outer Dimension (cm WxDxH): 47 x 29.5 x 61.9
Inner Dimension (cm WxDxH) Base: 41 x 24.5 x 33
Organizer: 43 x 24 x 5.8
Suitcase: 41 x 25 x 18
- 1-70-327 Outer Dimension (cm WxDxH): 47 x 29.5 x 57.3
Inner Dimension (cm WxDxH) Base: 41 x 24.5 x 33
Suitcase: 41 x 25 x 18

CODE	DESCRIPTION				PRICE
1-70-326	Mobile Work Center 3in1	-	2		
1-70-327	Mobile Work Center 2in1	-	2		

STANLEY® ROLLING WORKSHOP 2 IN 1



- 2in1 - quickly split into separate boxes
- Extra spacious Toolbox with removable tray
- Central organizer carousel and lid organizers
- Volume: 25L
- Capacity: 17kg
- Foldable handle
- Heavy duty wheels
- Durable 1 piece plastic construction
- Nickel plated metal latches
- Large metal latches on the sides with eye for padlock
- Outer dimensions (cm WxDxH): 47 x 29.5 x 61.9
- Inner Dimension (cm WxDxH) Base: 40 x 24 x 30
Organizer (x2): 16.5 x 7 x 5
Suitcase: 45 x 26 x 19.5

CODE	DESCRIPTION				PRICE
1-93-968	Mobile Work Center 2in1	-	2		

STANLEY® FATMAX® MOBILE JOB CHEST 240L

STANLEY
FATMAX



- Large job chest with a capacity of 240 litres
- Innovative top aluminum rails (attachment points)
- Dust and water resistant: IP65
- Heavy-duty 7" rubber wheels with a extra-wide bi-material telescopic handle for greater comfort and maneuverability
- Padlock loop and heavy duty metal latches and hinges for added durability
- Outer dimensions (cm WxDxH): 99 x 59 x 62
- Inner dimensions (cm WxDxH): 84 x 46 x 51

CODE	DESCRIPTION				PRICE
FMST1-75531	FATMAX Mobile job chest 240L	-	2		

STANLEY® FATMAX® MOBILE JOB CHEST 90L

STANLEY
FATMAX



- Vertical storage divider: Ideal for storing smaller hand tools, such as Knives and screwdrivers
- Strong metal latches & hinges - for extra durability
- Integrated V-groove: Located on the lid, suitable for sawing pipes and lumber
- Telescopic handle for easy transportation
- Outer Dimensions (cm WxDxH): 74.7 x 51.5 x 42.8
- Inner dimensions (cm WxDxH): 61 x 38.5 x 33.5

CODE	DESCRIPTION				PRICE
FMST1-73601	FATMAX Mobile job chest 90L	-	1		

STANLEY® FATMAX® MOBILE JOB CHEST 113L

STANLEY
FATMAX



- Capacity up to 113L
- Removable vertical tool organizer/divider
- Level and saw lock in mechanism - - Keeps tools accessible yet safely secured inside
- All round water seal - Keeps valuable contents safe
- Heavy duty wheels - For mobility on rough surfaces, stairs
- Portable tray - For hand tools and small parts
- Integrated Lock + Keys - - Keeps your tools protected
- Integrated V - Groove - For any on site sawing needs
- Telescopic handle - Slides in for storage
- Back end handle - Enables conveniently lifting onto vehicle by 2 people
- Outer Dimensions (cm WxDxH): 91 x 51.6 x 43.1
- Inner Dimension (cm WxDxH): 72 x 37.5 x 28.5

CODE	DESCRIPTION				PRICE
1-94-850	FATMAX Mobile Job chest 113L	-	1		

STANLEY® MOBILE JOB CHEST 91L



- Wide telescopic steel handle with soft grip, suitable for use with gloved hands.
- Removable tote tray fits neatly into the telescopic handle
- Heavy duty road tested wheels
- Butterfly screws on top lid for attaching level, hand saw and other accessories
- Extra large rust resistant metal latches, durable and long lasting with padlock eyes for security
- Maximum storage and easy transportation for larger tools, general equipment and workshop materials
- Outer dimensions (cm WxDxH): 74 x 42 x 47.5
- Inner dimensions (cm WxDxH): 68 x 36.5 x 43.5

CODE	DESCRIPTION				PRICE
1-92-978	Mobile job chest 91L	-	2		

STANLEY® MOBILE JOB CHEST 190L



- Integrated key lock for added security
- Wide telescopic steel handle with soft grip
- Removable tote tray fits neatly into the telescopic handle
- Heavy duty wheels
- Butterfly screws on top lid for attaching level, hand saw and other accessories
- Extra large rust resistant metal latches and padlock loop for security
- Outer Dimensions (cm WxDxH): 94.6 x 58.7 x 57.8
- Inner dimensions (cm WxDxH): 87 x 48 x 52

CODE	DESCRIPTION				PRICE
1-93-278	Mobile Job chest 190L	-	2		

STANLEY® MOBILE JOB CHEST ESSENTIAL 50L



- Wide telescopic plastic handle
- Removable internal tray
- Heavy duty wheels
- Integrated V-groove: Located on the lid, suitable for sawing pipes and lumber
- Metal rust-proof latches - for extra durability
- Padlock eye for extra security
- Outer dimensions (cm WxDxH): 67 × 40.5 × 34.5
- Inner dimensions (cm WxDxH): 54 × 30 × 27.5

CODE	DESCRIPTION	☐	☒	☐	PRICE
STST1-80150	Rolling Workshop Essential 50L	-	2	3 2535611801501	

STANLEY® ROLLING WORKSHOP 58L



- Removable organizer: Easy to remove and have all small parts organized and accessible
- Power tool easily accessible from portable tray or bottom bin
- Integrated V-groove: Located on the lid, suitable for sawing pipes and lumber
- 2/3 size portable tray allows for storage of larger/longer tools
- Outer dimensions (cm WxDxH): 62 × 37.5 × 42.5
- Inner dimensions (cm WxDxH): 57 × 31 × 29

CODE	DESCRIPTION	☐	☒	☐	PRICE
1-97-503	Rolling Workshop 53L	-	2	3 2535611975035	



CANTILEVER TOOLBOX Everything has its place

We often work with professionals. That's why we know you need to have the right tools at your fingertips to get the job done faster and easier. But small parts and accessories are easily lost at the bottom of the box. Everything remains visible in our popular cantilever model. That makes it easier to get the right tool when you need it. We were also told that it is essential that tools are not damaged. That is why this box is not only robust and sturdy, but also waterproof.

TOOLBOXES

STANLEY® FATMAX® STRUCTURAL FOAM TOOLBOX - 28"

STANLEY
FATMAX



- All round water seal for ultimate protection of equipment
- Constructed of structural foam for extra strength (IP53)
- Extra large storage capacity maximum volume utility (32L)
- Integrated V-Groove on top lid for sawing work needed, suitable for working with pipes and lumber
- 1-93-935 Outer Dimension (cm WxDxH): 71 x 29.4 x 32
Inner Dimension (cm WxDxH): 60 x 24.5 x 21.5
- 1-94-749 Outer Dimensions (cm WxDxH): 58 x 26.9 x 30.8
Inner Dimensions (cm WxDxH): 46.5 x 23 x 19.1

CODE	DESCRIPTION	✉	☒	📊	PRICE
1-93-935	FATMAX Toolbox Heavy Duty 28"	-	3		
1-94-749	FATMAX Toolbox Heavy Duty 23"	-	3		

STANLEY® FATMAX® TOOLBOX ON WHEELS - 28"

STANLEY
FATMAX



- Ergonomic heavy weight mobility
- All round water seal for ultimate protection of equipment
- Ergonomic recessed incorporated in the body for hand carrying heavy tools
- Metal telescopic pull/push handle and wheels
- Portable tote tray so no need to carry all in toolbox
- Large metal rust proof latches with padlock loop
- Integrated V-groove for work with lumbers and pipes
- Outer dimensions (cm WxDxH): 71 x 30 x 32
- Inner Dimension (cm WxDxH): 60.2 x 21.5 x 22.7

CODE	DESCRIPTION	✉	☒	📊	PRICE
FMST1-75761	FATMAX Toolbox with wheels 28"	-	3		

STANLEY® FATMAX® WATERPROOF TOOLBOX CANTILEVER 18"

STANLEY
FATMAX



- High performance seal for dust and water protection (IP53 water resistance)
- Long lasting and reliable product
- Plastic slides and robust metal latches
- Tool organization dividers (top and bottom drawers are the same)
- Dust and water resistant: IP53
- Outer dimensions (cm WxDxH): 46 x 23.5 x 31.5
- Inner Dimension (cm WxDxH): 37.5 x 22.5 x 11.3

CODE	DESCRIPTION	✉	☒	📊	PRICE
FMST1-71219	FATMAX Waterproof toolbox Cantilever 18"	-	3		

STANLEY® FATMAX® TOOLBOX METALL/PLASTIC

STANLEY
FATMAX



- Ergonomic bi-material handle
- Innovative vertical storage unit for better organisation
- Large metal rust proof latches with padlock eye keep tools safe
- Portable tray is designed to carry tools and small parts
- Integrated V-groove for work with lumbers and pipes
- Combines the benefits of plastic with the sturdiness of metal for ultimate protection of equipment stored inside
- 1-95-615 Outer Dimension (cm WxDxH): 50 x 29.7 x 29.3
Inner Dimension (cm WxDxH): 48 x 24 x 23
- 1-95-616 Outer Dimension (cm WxDxH): 58 x 29.7 x 29.3
Inner Dimension (cm WxDxH): 56 x 23 x 24
- 1-95-617 Outer Dimension (cm WxDxH): 66.6 x 29.7 x 29.3
Inner Dimension (cm WxDxH): 64 x 23 x 24

CODE	DESCRIPTION	✉	☒	📊	PRICE
1-95-615	FATMAX Toolbox Metall/Plastic 20"	-	3		
1-95-616	FATMAX Toolbox Metall/Plastic 23"	-	3		
1-95-617	FATMAX Toolbox Metall/Plastic 26"	-	3		

STANLEY® TOOLBOX - PLASTIC & GALVANIZED METAL

- Ergonomic bi-material handle
- Large metal rust proof latches with padlock eye keep tools safe
- Portable tray designed to carry tools and small parts
- Integrated V-groove for work with lumbers and pipes
- Combines the benefits of plastic with the sturdiness of metal
- 1-95-612 Outer Dimension (cm WxDxH): 50 x 29.7 x 22.2
Inner Dimension (cm WxDxH): 48 x 24 x 18
- 1-95-613 Outer Dimension (cm WxDxH): 58 x 29.7 x 22.2
Inner Dimension (cm WxDxH): 56 x 23 x 18
- 1-95-614 Outer Dimension (cm WxDxH): 66.6 x 29.7 x 22.2
Inner Dimension (cm WxDxH): 63.5 x 22.5 x 17.2



CODE	DESCRIPTION	✉	☒	📊	PRICE
1-95-612	Toolbox Metall/Plastic 20"	-	4		
1-95-613	Toolbox Metall/Plastic 23"	-	4		
1-95-614	Toolbox Metall/Plastic 26"	-	4		

STANLEY® TOOLBOX - PLASTIC & GALVANIZED METAL



- Ergonomic bi-material handle
- Large metal rust proof latches with padlock eye keep tools safe
- Portable tray designed to carry tools and small parts
- Integrated V-groove for work with lumbers and pipes
- Combines the benefits of plastic with the sturdiness of metal
- 1-95-618 Outer Dimension (cm WxDxH): 50 x 29.7 x 22.2
Inner Dimension (cm WxDxH): 48 x 24 x 18
- 1-95-619 Outer Dimensions (cm WxDxH): 58 x 29.7 x 22.2
Inner Dimensions (cm WxDxH): 56 x 23 x 18
- 1-95-620 Outer Dimension (cm WxDxH): 66.6 x 29.7 x 22.2
Inner Dimension (cm WxDxH): 63.5 x 22.5 x 17.2

CODE	DESCRIPTION	☐	☒	☐	PRICE
1-95-618	Toolbox Metall/Plastic Galva 20"	-	4	3 253561 956188	
1-95-619	Toolbox Metall/Plastic Galva 23"	-	4	3 253561 956195	
1-95-620	Toolbox Metall/Plastic Galva 26"	-	4	3 253561 956201	

STANLEY® TOOLBOX - PLASTIC & GALVANIZED METAL - WITH DRAWER 20"



- Metal galvanized body and plastic frame
- Portable tote tray 3/4 length design to allow storage of large tools
- Large metal rust proof latches with padlock eye
- Ergonomic bi-material handle for carrying heavy loads Integrated V-grooves on top lid - suitable for pipes and lumber
- Deep 4" drawer for small parts organization or for power tool storage
- Ball bearing slides for heavy loads
- Outer Dimensions (cm WxDxH): 54.5 x 29.5 x 28
- Inner Dimension (cm WxDxH): 48.2 x 23.7 x 13.7

CODE	DESCRIPTION	☐	☒	☐	PRICE
1-95-829	Toolbox Metall/Plastic with drawer 20"	-	2	3 253561 958298	

STANLEY® TOOLBOX - PLASTIC & GALVANIZED METAL - WITH DRAWER 20"



- Metal galvanized body and plastic frame
- Portable tote tray 3/4 length design to allow storage of large tools
- Large metal rust proof latches with padlock eye
- Ergonomic bi-material handle for carrying heavy loads Integrated V-grooves on top lid - suitable for pipes and lumber
- Deep 4" drawer for small parts organization or for power tool storage
- Ball bearing slides for heavy loads
- Outer Dimensions (cm WxDxH): 54.5 x 33.5 x 28
- Inner Dimension (cm WxDxH): 48.2 x 23.7 x 13.7

CODE	DESCRIPTION	☐	☒	☐	PRICE
1-95-830*	Toolbox Galva Metall/Plastic with drawer 20"	-	2	3 253561 958304	

*Not in the Nordic assortment - special order required. Minimum order quantity applied.

STANLEY® METAL CANTILEVER TOOLBOX - 18"



- Electro-powder coating to resist scratch and solvent markings
- Heavy duty metal for body construction and handle to provide ultimate durability
- Double latch for greater strength tray swing out for easy tool access
- Double handle for more comfort
- Outer Dimensions (cm WxDxH): 45 x 20.8 x 20.8

CODE	DESCRIPTION	☐	☒	☐	PRICE
1-94-738	Toolbox Metal Cantilever 5 drawers	-	1	3 253561 947384	

STANLEY® TOOLBOX WITH CASE & OPEN TOTE 24"



- 24" Tote with a top case for Power-Tools and small parts
- Front push button for simple detaching of the top part from the bottom tote
- Heavy duty anti-rust metal latches on top case and metal hinges for extra strength and durability
- Outer dimensions (cm WxDxH): 67 x 29 x 32
- Inner Dimension (cm WxDxH): 56.5 x 22.5 x 17

CODE	DESCRIPTION	☐	☒	☐	PRICE
1-97-506	Toolbox with case 24"	-	3	3 253561 975066	

STANLEY® TOOLBOX WITH ORGANIZER & OPEN TOTE 24"



- Toolbox with a removable organizer combines maximum tool storage with onsite maneuverability
- Heavy duty design, robust structure and structural foam look
- Long metal carry handle for the Tote for easy and better grip - locks in place for carrying; tilts down for storage
- Outer dimensions (cm WxDxH): 67 x 25 x 32
- Inner Dimension (cm WxDxH): 56.5 x 22.5 x 17

CODE	DESCRIPTION	☐	☒	☐	PRICE
1-97-514	Toolbox with organizer & tote 24"	-	3	3 253561 975141	

STANLEY® TOOLBOX WITH ORGANIZER & OPEN TOTE 19"

- Toolbox with a removable organizer combines maximum tool storage with onsite maneuverability
- Heavy duty design, robust structure and structural foam look
- Long metal carry handle for the Tote for easy and better grip - locks in place for carrying; tilts down for storage
- Can be combined with Rolling Workshop 1-79-206
- Outer Dimensions (cm WxDxH): 55.6 x 24.9 x 32
- Inner Dimension (cm WxDxH): 47 x 22.5 x 16.7



CODE	DESCRIPTION				PRICE
STST1-70317*	Toolbox with organizer & tote 19"	-	3	3 2535611703171	

**Not in the Nordic assortment - special order required. Minimum order quantity applied.*

STANLEY® TOOLBOX ONELATCH WITH DRAWER 19"

- 19" toolbox with One-latch operation
- Ball bearing slides drawer: versatile organization for various sizes of tools and small parts
- Heavy duty design for extra strength and durability
- Extra width soft grip handle on top for easy lifting
- 2/3 removable tray allows enough space for large tools to be stored underneath
- V-Groove on top lid for on-site sawing needs
- Integrated padlock eye for securing tools and contents
- Outer Dimensions (cm WxDxH): 48.3 x 27.9 x 28.7
- Inner Dimension (cm WxDxH) Suitcase: 48.3 x 27.9 x 28.7
Drawer: 45 x 34 x 20



CODE	DESCRIPTION				PRICE
1-70-316	Toolbox onelatch with Drawer 19"	-	3	3 2535611703164	

STANLEY® FATMAX® TOOLBOX

STANLEY
FATMAX

- Unique tray design with removable cup compartments in various sizes and long space suitable for hand tools and accessories
- Long aluminium handle for a better grip which makes it easy and comfortable to carry and lift
- Cantilever sliding tray creates a two level work station
- Dust and water protection: IP 54
- FMST1-75792 Outer Dimension (cm WxDxH): 51.5 x 27.5 x 30
Inner Dimension (cm WxDxH): 45 x 23.5 x 19.2
- FMST1-75791 Outer Dimension (cm WxDxH): 67 x 27.5 x 30
Inner Dimension (cm WxDxH): 59.5 x 23 x 19.4



CODE	DESCRIPTION				PRICE
FMST1-75792	FATMAX Pro Aluminum Cantilever Toolbox 20"	-	3	3 2535611757921	
FMST1-75791	FATMAX Pro Aluminum Cantilever Toolbox 26"	-	3	3 2535611757914	

STANLEY® TOOLBOX WITH ORGANIZER CLICK & CONNECT

- Unique design that perfectly fits home surrounding
- Special proportions: size, shape and proportions for easy access to tools and power tools
- Removable latches enable easy connecting and detaching, and full visibility and accessibility
- Removable dividers enable personal customization and organization of tools
- Lid organizers for small accessories, drills and bits storage
- STST1-71962 Outer Dimension (cm WxDxH): 50.5 x 24.5 x 31



CODE	DESCRIPTION				PRICE
STST1-71962*	toolbox with organizer Click & Connect	-	2	3 2535611719622	

**Not in the Nordic assortment - special order required. Minimum order quantity applied.*

STANLEY® TOOLBOX ONELATCH 24"

- 2/3 removable tray, allows enough space for larger tool to be stored underneath
- 24" tool box with one hand operation latch, allows easy opening when other hand is occupied
- Extra width soft grip handle on top for easy lifting
- Toolbox lid includes integrated V-groove for work with lumbars and pipes
- Outer Dimensions (cm WxDxH): 60.3 x 28.7 x 28.2



CODE	DESCRIPTION				PRICE
1-97-510	Toolbox onelatch 24"	-	3	3 2535611975103	

STANLEY® TOOL BOXES WITH METAL LATCHES

- Good solution the DIY'er or hobbyist
- Metal latches, professional quality/strength
- Storage tray for smaller items more frequently used
- Internal Tote Tray



CODE	DESCRIPTION				PRICE
1-92-064	Tool Box with Metal Latches 12,5"	-	6	3253561920646	
1-92-065	Tool Box with Metal Latches 16"	-	6	3253561920653	
1-92-066	Tool Box with Metal Latches 19"	-	6	3253561920660	
1-92-067	Tool Box with Metal Latches 24"	-	6	3253561920677	

STANLEY® TOOLBOX 19"



- Keep everything to hand with the STANLEY® Cantilever Tool Box which features 3 levels of storage for hassle free access to your tools and accessories. The Tool Box has 2 internal trays which are designed for easy organisation of smaller hand tools as well as 2 lid organiser compartments, ideal for storing small fixings and accessories. Complete with a pull handle for easy closure of the tool box, as well metal latches for durability. The STANLEY® 3-Level Cantilever Tool Box is finished with a textured carry handle for comfort and easy transportation.
- Outer dimensions (cm WxDxH): 49 x 25.5 x 28.5 (closed)
- Inner Dimension (cm WxDxH): 43.5 x 21.4 x 11

CODE	DESCRIPTION				PRICE
STST83397-1	Toolbox Cantilever Essential 19"	-	2		

STANLEY® TOOLBOX ESSENTIAL WITH REMOVABLE ORGANISERS



- Ideal for storing smaller hand tools and features two removable organizers for quick and easy access to small materials and accessories
- Equipped with a removable tray for storing small parts
- Metal rustproof latch for durability
- Lockable with padlock (not included)
- STST75785-1 Outer Dimension (cm WxDxH): 40.6 x 19.5 x 20.5
Inner Dimension (cm WxDxH): 37 x 15 x 15
- STST75787-1 Outer Dimension (cm WxDxH): 48.2 x 25 x 25.4
Inner Dimension (cm WxDxH): 43 x 18 x 20

CODE	DESCRIPTION				PRICE
STST75785-1	Toolbox Essential 16" removable organizers	-	6		
STST75787-1	Toolbox Essential 19" removable organizers	-	6		



STANLEY® TOOLBOX ONE-TOUCH



- Toolbox with ONE HAND OPERATION latch allows easy opening when other hand is occupied
- Lid with organizers
- Wide soft grip handle
- Removable Internal tray
- 1-79-216 Outer Dimension (cm WxDxH): 39.4 x 16.2 x 22
Inner Dimension (cm WxDxH): 36.5 x 15 x 11.7
- 1-79-217 Outer Dimension (cm WxDxH): 48.6 x 23.6 x 26.6
Inner Dimension (cm WxDxH): 46.5 x 20.5 x 22.6
- 1-79-218 Outer Dimension (cm WxDxH): 59.5 x 26 x 28.1
Inner Dimension (cm WxDxH): 56 x 23 x 20

CODE	DESCRIPTION				PRICE
1-79-216	Toolbox One-Touch 16"	-	6		
1-79-217	Toolbox One-Touch 19"	-	6		
1-79-218	Toolbox One-Touch 24"	-	3		

STANLEY® TOOLBOX ESSENTIAL



- Organizer for small parts
- Metal or plastic latches - lock guarantee, enables smooth closing and opening
- Removable Internal tray

CODE	DESCRIPTION				PRICE
STST1-75514	Toolbox Essential 12.5" - plastic latches	-	6		
STST1-75515	Toolbox Essential 12.5" - metal latches	-	6		
STST1-75517	Toolbox Essential 16" - plastic latches	-	6		
STST1-75518	Toolbox Essential 16" - metal latches	-	6		
STST1-75520	Toolbox Essential 19" - plastic latches	-	6		
STST1-75521	Toolbox Essential 19" - metal latches	-	6		
STST82976-1	Toolbox Essential 26" - metal latches	-	3		
STST1-75772	Toolbox Essential - bundle 19" - 12.5" - metal latches	-	6		

FATMAX® TOOLBOX - 3-IN-1 - STEP STOOL, TOOL BOX, AND TOTE - 25"



- The STANLEY® FATMAX® 25" step stool toolbox provides a three-in-one solution: a toolbox, a step stool and a raised tote
- 30kg tool box load capacity for well-organized storage of small power tools and hand tools
- The tool box features an ergonomic carry handle for easy transportation
- 45cm working height and 150kg standing load capacity (Conforms to EN14183 step stool standards)
- The product features an integrated tote with dual use side latches. These latches clip the tote to the step stool to provide elevated height
- Outer Dimensions (cm WxDxH): 64 x 29.6 x 28.7
- Inner Dimension (cm WxDxH): 56 x 26.5 x 20
- Work surface dimensions (cm): 53 x 25

CODE	DESCRIPTION				PRICE
FMST81083-1	FATMAX 3in1 Toolbox with Step stool 25"	-	2		

STORAGE TRAY



- Comfort handle structure
- Large open tote tray suitable for portable storage
- Maximum visibility and accessibility
- Outer Dimensions (cm WxDxH): 49.7 x 33.6 x 19.4
- Inner Dimension (cm WxDxH): 40 x 10 x 13.3 (x2)

CODE	DESCRIPTION				PRICE
STST1-72359	Storage Tray	-	6		

TECHNICIANS CASES

STANLEY® FATMAX® TECHNICIAN CASE

STANLEY
FATMAX



- Accordion structure
- Enabling full visibility and accessibility
- Removable dividers for flexible customization & organization 1 long divider 4 short dividers 3 cups & covers
- Supporting legs for stability (no tipping over)
- Thick rubber coated handle for superior grip
- Tough metal latches
- Outer Dimensions (cm WxDxH): 50.1 x 20.3 x 40.5
- Inner Dimension (cm WxDxH): 47 x 31.3 x 11.3

CODE	DESCRIPTION	☐	☒	☐	PRICE
FMST1-71943	FATMAX Technicians Case - not filled	-	1	3 253561 719431	

FATMAX® TECHNICIANS CASE WITH WHEELS

STANLEY
FATMAX



- Accordion structure
- Enabling full visibility and accessibility
- Ergonomic tall aluminum telescopic handle and bearing skating wheels for smooth and easy mobility
- Glass fiber reinforced PP body and lid for durability
- Removable dividers for flexible customization & organization 1 long divider 4 short dividers 3 cups & covers
- Supporting legs for stability (no tipping over)
- Thick rubber coated handle for superior grip
- Tough metal latches
- Outer Dimensions (cm WxDxH): 54.3 x 40.5 x 24
- Inner Dimension (cm WxDxH): 47 x 31.3 x 11.3

CODE	DESCRIPTION	☐	☒	☐	PRICE
FMST1-72383	FATMAX Technicians Suitcase with wheels - not filled	-	1	3 253561 723834	



THE FATMAX® QUICK ACCESS BACKPACK

Tools at your fingertips

Many professionals told us that they spend a lot of time reorganizing their toolbox, depending on the job that is scheduled for the day. This was partly due to the inefficient use of space in their current toolbox. To remedy this, we made a tool bag in which the tools can be stored upright.

TOOL BAGS

STANLEY® FATMAX® QUICK-ACCESS BACKPACK

STANLEY
FATMAX



- Large open compartment for quick tool access intended for long tools/organisers/power tools/kit boxes
- Tool back pack– workstation with 4 compartments combines high strong flexible high quality tarpaulin with 600D
- Multiple pockets and tool holders for a wide variety of tools
- Rigid, water-proof plastic bottom
- Padded shoulder straps for heavy load carriage
- Ergonomic padded back with air mesh
- Laptop padded compartment
- Personal belongings compartment or all essentials: wallet, keys, cell phone
- Dimensions (cm WxDxH): 36 x 23 x 47

CODE	DESCRIPTION				PRICE
FMST1-80144	FATMAX Backpack Quick Access	-	4	3 253561 801440	

STANLEY® FATMAX® BACKPACK WITH/WITHOUT WHEELS

STANLEY
FATMAX



- 600 x 600 durable denier fabric
- Easy access to personal items stored in a different compartment
- Dual zipper closure enables opening from every end
- Front see through compartment and multiple loops for extra loads enables quick access needs
- Loops provide additional fastening options
- Removable divider with multiple pockets for a wide variety of tools
- Rigid form that can stand in an open position enabling access to all tools
- Carrying capacity: 25kg
- Transporting handle used during rolling carriage of tools
- 1-79-215 dimensions (cm WxDxH): 36 x 21 x 54
- 1-95-611 dimensions (cm WxDxH): 36 x 21 x 49.5

CODE	DESCRIPTION				PRICE
1-79-215	FATMAX Tool backpack with wheels	-	2	3 253561 792151	
1-95-611	FATMAX Tool backpack without wheels	-	2	3 253561 956119	

STANLEY® BACKPACK WITH/WITHOUT WHEELS



- Transport heavy loads on wheels using the telescopic handle or carry comfortably on your back using the two ergonomic shoulder straps
- Made from 600-denier fabric for long lasting durability
- Two ergonomic, padded shoulder straps spread the weight distribution
- Wide opening zip design for easy access
- Removable tool divider system
- Side pockets for convenient access
- Comfortable telescopic handle for use on wheels
- STST83307-1 dimensions (cm WxDxH): 34 x 20 x 57
- STST1-72335 dimensions (cm WxDxH): 30.5 x 18.5 x 47.5

CODE	DESCRIPTION				PRICE
STST83307-1	Tool backpack with wheels	-	4	3 253561 833076	
STST1-72335	Tool backpack without wheels	-	4	3 253561 723353	

STANLEY® FATMAX® LAPTOP BAG

STANLEY
FATMAX



- Waterproof bottom
- 600 x 600 denier
- Front opening for easy access to tools
- Protected compartment for laptop, tablet or documents
- Inner and outer pockets for maximum storage capacity
- Padded shoulder straps
- Ergonomic handle
- Can be combined with the FATMAX tool bag on wheels thanks to the handy strap on the back
- Dimensions (cm WxDxH): 42.5 x 15 x 32

CODE	DESCRIPTION				PRICE
FMST1-80149	FATMAX Laptop Bag	-	4	3 253561 801495	

STANLEY® FATMAX® QUICK-ACCESS TOTE 20"

STANLEY
FATMAX



- Open tool tote with a compartment pocket on the outside
- Robust, steel handle and padded shoulder strap
- 600 x 600 denier in combination with tarpaulin
- Waterproof bottom
- Dimensions (cm WxDxH): 50 x 30 x 36

CODE	DESCRIPTION				PRICE
FMST1-80146	FATMAX Open Tote Quick Access	-	4	3 253561 801464	

STANLEY® FATMAX® TOOL BAG QUICK ACCESS

STANLEY
FATMAX



- Tool bag with 3 large compartments
- Inner and outer pockets for maximum storage capacity
- 600 x 600 denier in combination with tarpaulin
- Padded shoulder strap
- Waterproof bottom
- 1-97-518 or 1-97-517 fits inside the bag
- Dimensions (cm WxDxH): 48.3 x 28.5 x 35

CODE	DESCRIPTION				PRICE
FMST1-80147	FATMAX Tool Bag Quick Access	-	4	3 253561 801471	

STANLEY® FATMAX® TOOL BAG WITH WHEELS

STANLEY
FATMAX

- Telescopic handle and wheels
- Large storage capacity (xL)
- Inner and outer pockets for maximum storage capacity
- Removable tool carrier
- 600x600 denier
- Dimensions (cm WxDxH): 45 x 25.5 x 33



CODE	DESCRIPTION				PRICE
FMST1-80148	FATMAX Tool Bag with Wheels	-	2	3 2535611801488	

FATMAX® LARGE TOOL BAG 18"

STANLEY
FATMAX

- Made from durable materials for maximum wear protection
- Polypropylene base for protection against moisture and dirt
- Large opening and handy compartments
- Vertical compartments for quick access to all tools and small parts
- Ergonomic design with comfortable shoulder strap and rubber handle
- Made from durable materials for maximum wear protection
- Large capacity - round opening offers more storage options than traditional tool bags
- Ergonomic design with comfortable shoulder strap and rubber handle
- Carrying capacity: 25kg
- Dimensions (cm WxDxH): 50 x 23 x 27



CODE	DESCRIPTION				PRICE
FMST1-71180	FATMAX Large Tool Bag 18"	-	2	3 2535611711800	

STANLEY® FATMAX® DOUBLE-SIDED TOOL BAG

STANLEY
FATMAX

- Extra Sturdily, double-sided construction for quick and easy access to tools and small parts
- Two deep compartments with large storage space for power tools
- Features multiple internal and external compartments Supplied with shoulder strap for maximum comfort
- Dimensions (cm WxDxH): 43 x 28 x 31



CODE	DESCRIPTION				PRICE
FMST1-73607	FATMAX Double Sided Tool Bag	-	4	3 2535611736070	

FATMAX® ROUND TOOL BAG 18"

STANLEY
FATMAX

- Made from durable materials for maximum wear protection
- Large capacity - round opening offers more storage options than traditional tool bags
- Vertical compartments for quick access to all tools and small parts
- Ergonomic design with comfortable shoulder strap and rubber handle
- Carrying capacity: 25kg
- Dimensions (cm WxDxH): 50 x 26 x 31



CODE	DESCRIPTION				PRICE
FMST1-70749	FATMAX Round Tool Bag 18"	-	2	3 2535611707490	

STANLEY® FATMAX® LARGE TOOL BAG ON WHEELS

STANLEY
FATMAX

- Extra large tool bag with wheels, telescopic handle, separate storage compartments for power tools, hand tools and accessories
- Sturdily 600 x 600 denier fabric
- Large zippered opening for easy access
- Handy storage compartment reachable from the outside
- Dimensions (cm WxDxH): 70 x 31.8 x 30.5



CODE	DESCRIPTION				PRICE
FMST82706-1	FATMAX Large Tool Bag on Wheels	-	2	3 2535611827068	

FATMAX® PLUMBERS BAG 19"

STANLEY
FATMAX

- Can be fully unfolded
- Double opening for separate access to materials and tools
- Durable protective material for sides anti moisture and dirty surfaces
- Suitable for storing pipe cutters, pipe benders, wrenches, etc.
- Outer and inner pockets for neatly storing tools
- Vertical compartments for quick access to all tools and small parts
- Polypropylene base for protection against moisture and dirt
- Comfortable shoulder strap
- Carrying capacity: 25kg
- Dimensions (cm WxDxH): 48.5 x 24 x 30



CODE	DESCRIPTION				PRICE
FMST1-70719	FATMAX Plumbers bag	-	2	3 2535611707193	

FATMAX® TOOL ORGANIZER

STANLEY
FATMAX



- Ergonomic bag with shoulder strap and two handles that can be attached together in one rigid rubber handle
- Reinforced frame and plastic supports: protection against moisture
- Velcro on both sides to keep the bag open: tools 100% visible
- Contrasting background
- Carrying capacity: 20kg
- Dimensions (cm WxDxH): 49 x 23 x 27

CODE	DESCRIPTION				PRICE
1-94-231	FATMAX Organizer Bag	-	2		

FATMAX® TOOL BAG

STANLEY
FATMAX



- Large handles for comfortable grip
- Heavy duty shoulder strap
- Reinforced handle attachment points
- Handy zipper
- Reinforced corners and other critical points
- Inner and outer pockets and elastic bands for maximum storage capacity
- Carrying capacity: 25kg
- Dimensions (cm WxDxH): 46 x 21 x 31

CODE	DESCRIPTION				PRICE
1-93-950	FATMAX Tool Bag 18"	-	4		

FATMAX® OPEN TOTE 18"

STANLEY
FATMAX



- Robust steel handle with rubber grip
- Heavy duty shoulder strap
- Saw compartments with adhesive tape closure
- Non-slip rubber holder for spirit level
- Large side pocket for extension cable
- Closed compartments for bits & bitsholders
- Elastics for maximum organization
- Tape measure holder - steel
- Carrying capacity: 25kg
- Dimensions (cm WxDxH): 47 x 20 x 34.5

CODE	DESCRIPTION				PRICE
1-93-951	FATMAX Open Tote 18"	-	4		

FATMAX® OPEN TOOL BAG 20"

STANLEY
FATMAX



- Inner and outer pockets for maximum storage capacity
- Made from tough 600 denier and ballistic nylon fabric
- Outside pocket with zipper
- Spacious Sturdily polypropylene frame
- Fold-away handle over the full length of the bag
- Carrying capacity: 25kg
- Dimensions (cm WxDxH): 49 x 25 x 29.5

CODE	DESCRIPTION				PRICE
1-79-213	FATMAX Open Tool Bag FP - lockable	-	4		

FATMAX® TECHNICIAN TOTE 10"

STANLEY
FATMAX



- Ergonomic rubber handle
- Heavy duty shoulder strap
- Removable divider with tool holders and belt clip
- Inner and outer pockets for maximum storage capacity
- Steel holders for insulating tape and tape measure
- Closed compartments for bit holders
- Carrying capacity: 25kg
- Dimensions (cm WxDxH): 26 x 26 x 26

CODE	DESCRIPTION				PRICE
1-93-952	FATMAX Technician Tote 10"	-	4		

STANLEY® FATMAX® SOFT TOOL ORGANISER

STANLEY
FATMAX



- Soft Tool Organiser features multiple layers of pockets for maximum organisation and easy access to tools
- Rigid waterproof plastic base: Enables the bag to stand on its own and protects the bag contents from dirt and moisture
- Base is compatible with STANLEY® FATMAX® Power Tool Accessory cases & PRO-STACK
- Integrated tape holder
- Padded shoulder strap
- Integrated hammer compartment
- Carrying capacity: 18kg

CODE	DESCRIPTION				PRICE
FMST17624-1	STANLEY® FATMAX® Soft Tool Organiser	-	4		

NEW

TOOL BAG WITH WHEELS 18"



- 600x600 denier fabric
- Sturdily frame
- Telescopic handle and wheels
- Inner and outer pockets
- Removable partition
- Dimensions (cm WxDxH): 44.5 x 25.5 x 42

CODE	DESCRIPTION				PRICE
1-97-515	Tool Bag with Wheels 18"	-	2	3 253561 975158	

STANLEY® TOOL BAG 300 MM



- Reinforced plastic bottom
- 8 inner pockets and 2 outer pockets
- Sturdily 600 x 600 denier fabric
- Dimensions (cm WxDxH): 30 x 13 x 25

CODE	DESCRIPTION				PRICE
1-93-330*	Tool bag 300 mm	-	2	3 253561 933301	

*Not in the Nordic assortment - special order required. Minimum order quantity applied.

OPEN TOOL TOTE 16"



- Sturdily 600 x 600 denier fabric
- Open structure
- Adjustable shoulder strap
- Reinforced plastic bottom
- Several inner and outer pockets
- Sturdily handle
- Dimensions (cm WxDxH): 42 x 22 x 26.5

CODE	DESCRIPTION				PRICE
1-96-182	Open Tool Tote 16"	-	4	3 253561 961823	

STANLEY® TOOL BAG 16"



- Reinforced plastic bottom
- Several inner and outer pockets
- Sturdily 600 x 600 denier fabric
- Dimensions (cm WxDxH): 43 x 23.5 x 27.5

CODE	DESCRIPTION				PRICE
1-96-183	Tool bag 16"	-	4	3 253561 961830	

STANLEY® ESSENTIAL RIGID MULTIPURPOSE TOOL BAG 16"



- Sturdily 600 x 600 denier fabric
- Several inner and outer pockets
- Adjustable shoulder strap
- Reinforced plastic bottom
- Reinforced corners
- Transparent document holder
- Dimensions (cm WxDxH): 43 x 25 x 26

CODE	DESCRIPTION				PRICE
1-96-193	Sturdily Tool Bag 16"	-	4	3 253561 961939	

STANLEY® OPEN TOOL BAG 12"



- Open design for easy access to all tools
- Vertical compartments for maximum organization
- Small compartments for screwdriver bits and other small parts
- Dimensions (cm WxDxH): 30 x 18 x 25

CODE	DESCRIPTION				PRICE
STST1-70718	Open Tool Bag 12"	-	4	3 253561 707186	

STANLEY® OPEN TOTE 18"



- 600 x 600 denier fabric, hardwearing, strong and durable
- Adjustable shoulder strap
- Covered front pocket provides secure storage of small parts or personal items
- Internal and external pockets provides maximum organization
- Open bulky structure design allows easy access and visibility to tools
- Strong metal handle for easy grip
- Side straps for level holder

CODE	DESCRIPTION				PRICE
STST1-70712	Tool pouch	-	12	3 253561 936012	

STANLEY® TOOL POUCH



- Strong, durable
- 12 compartments
- Dimensions (cm WxDxH): 64.5 x 38.5 x 0.5

CODE	DESCRIPTION				PRICE
1-93-601*	Tool pouch	-	12	3 253561 936012	

*Not in the Nordic assortment - special order required. Minimum order quantity applied.

STANLEY® PERSONAL BELT BAG



- Sturdily 600 x 600 denier fabric
- Large zippered storage space
- Handy storage bag for personal items & mobile phone pocket
- Dimensions (cm WxDxH): 24 x 6 x 15.5

CODE	DESCRIPTION				PRICE
1-96-179	Personal Tool Bag	-	4	3 253561 961793	

TOOL BELTS

STANLEY® FATMAX® TOOL VEST

STANLEY
FATMAX



- Compartments for storing hand tools
- Adjustable shoulder straps for maximum comfort
- Breathable fabric for maximum comfort
- One size adjustable reflector strips for safety
- One size fits all, thanks to the fully adjustable side straps
- Dimensions (cm WxDxH): 47 x 7 x 58

CODE	DESCRIPTION				PRICE
FMST1-71181	FATMAX Tool Vest	-	2	3 253561 711817	

STANLEY® FATMAX® KNIFE HOLSTER

STANLEY
FATMAX



- Cut proof plastic interior to resist wear and punctures
- Trouser clip
- 600 denier polyester for long life
- Heavy-duty stitching to perform under heavy usage
- Pocket for 10 pack blades for convenience
- Strong belt clip for attachment
- Pouch fits all Stanley Knives

CODE	DESCRIPTION				PRICE
0-10-028	FATMAX Knife Holster	X	6	3 253560 100285	

STANLEY® TOOL BELT



- Made from durable quality leather
- Stitched hems
- Reinforcing rivets that are covered to prevent damage to clothes
- 4 large and 6 small bags
- 2 hammer holders and 1 measuring tape holder
- Fully adjustable strap
- Dimensions (cm WxDxH): 53.34 x 38.1 x 38.1

CODE	DESCRIPTION				PRICE
STST1-80113	Double Tool Belt	X	2	3 253561 801136	

STANLEY® SINGLE TOOL BELT WITH HAMMER HOLDER



- Made from durable quality leather
- Various pouches and holders for ease of use
- Reinforcing rivets for more durability
- Wide belt slot
- Hammer holder
- Dimensions (cm WxDxH): 40.64 × 33.02 × 27.94

CODE	DESCRIPTION				PRICE
STST1-80114	Single Tool Belt with Hammer Holder	-	2	3 2535611801143	

STANLEY® SINGLE TOOL BELT



- Made from durable quality leather
- Various pouches and holders for ease of use
- Reinforcing rivets for more durability
- Wide slot for belt
- Metal tape measure holder
- Dimensions (cm WxDxH): 40.64 × 33.02 × 27.94

CODE	DESCRIPTION				PRICE
STST1-80116	Single Tool Belt	-	2	3 2535611801167	

STANLEY® STANLEY® HAMMER HOLSTER



- Made from durable quality leather
- Hammer holder - suitable for different types and weights
- Reinforcing rivets for greater durability
- Dimensions (cm WxDxH): 57.15 × 38.1 × 45.72

CODE	DESCRIPTION				PRICE
STST1-80117	hammer holster	-	20	3 2535611801174	

STANLEY® DRILL HOLDER



- Made from durable quality leather
- Suitable for left and right handed users
- Leather strap keeps device in place
- Different pouches for drills and bits
- Dimensions (cm WxDxH): 53.34 × 38.1 × 38.1

CODE	DESCRIPTION				PRICE
STST1-80118	Drill holder	-	2	3 2535611801181	

STANLEY® BELT



- Made from durable quality leather
- One size fits all
- Durable metal closure
- Dimensions (cm WxDxH): 57.15 × 38.1 × 45.72

CODE	DESCRIPTION				PRICE
STST1-80119	Belt	X	6	3 2535611801198	

STANLEY® TOOL BELT



- Sturdily 600 × 600 denier fabric
- Various pouches & tool holders (hammer holder & tape measure holder)
- Padded
- Belt included
- Dimensions (cm WxDxH): 60 × 7.5 × 25.5

CODE	DESCRIPTION				PRICE
1-96-178	Tool belt	-	4	3 2535611961786	

STANLEY® TOOL POUCH



- Sturdily 600 × 600 denier fabric
- Various pouches & tool holders (hammer holder)
- Padded
- Dimensions (cm WxDxH): 24 × 6 × 15.5

CODE	DESCRIPTION				PRICE
1-96-181	Tool Pouch	-	4	3 2535611961816	

STANLEY® TOOL/PEN POUCH



- Sturdily 600 × 600 denier fabric
- Two side pockets for convenient tool storage
- Large center pocket
- Ideal for pens
- Dimensions (cm WxDxH): 16 × 11 × 24

CODE	DESCRIPTION				PRICE
1-93-329*	Tool/Pen Pouch	X	12	3 2535611933295	

*Not in the Nordic assortment - special order required. Minimum order quantity applied.

KNEE PADS

STANLEY® FATMAX® KNEE PADS HARD SHELL

STANLEY
FATMAX



- A non-slip layer allows for better traction and durability when in use
- Ideal for protecting the knees when participating in framing, carpentry, automotive or general construction work
- 600 Denier fabric
- High density foam padding for added comfort
- Dual elastic adjustable straps along with swivelling buckles for comfort and adjustability
- Dimensions (cm WxDxH): 23.5 x 5 x 16

CODE	DESCRIPTION				PRICE
FMST82961-1	FATMAX Knee Pads Hard Shell	X	4	3 253561 829611	

FATMAX® KNEE PADS SOFT FLOORING

STANLEY
FATMAX



- A non-slip layer allows for better traction and durability when in use
- Dual elastic adjustable straps with swivelling buckles and latches for comfort and adjustability
- Thick layer of EVA high density foam padding for added comfort
- 1680 Denier fabric provides added strength and abrasion resistance to the knee pads
- Dimensions (cm WxDxH): 22 x 7.5 x 19

CODE	DESCRIPTION				PRICE
FMST82962-1	FATMAX Kneepads Soft	X	4	3 253561 829628	

STANLEY® FATMAX® SEMI-HARD THERMOFORMED KNEE PADS WITH GEL

STANLEY
FATMAX



- The semi-rigid construction offers improved protection
- Extra wide single neoprene strap for added comfort and a secure fit
- Easy to grasp pull tabs allow easy adjustment to the knee pads even whilst wearing gloves
- Thick layer of EVA high density foam padding
- 1680 Denier fabric
- The semi-rigid flat cap with TPE offers the ultimate protection and slip prevention (only for FMST82960-1)
- Dimensions (cm WxDxH): 24 x 7 x 17.5

CODE	DESCRIPTION				PRICE
FMST82959-1	FATMAX Knee Pads Thermoformed Gel	X	2	3 253561 829598	

CODE	DESCRIPTION				PRICE
FMST82960-1	STANLEY® FATMAX® Stabilized Knee Pads with Gel	X	2	3253561829604	

THE FATMAX® PRO-STACK STORAGE SYSTEM

Completely tailored for you

Designed to your size. The PRO-STACK modular storage cases offer you all options, tailored for your task. Your PRO-STACK is the ideal partner to complete your tasks quickly and professionally - with an eye for robustness and user-friendliness. Each case is equipped with a sturdy coupling system to connect or disconnect the cases quickly and easily. This way you can put together your ideal combination yourself. Add the organizer for the small items and a wheel base for easy transport.



CUSTOMIZE YOUR PRO-STACK SYSTEM

TOOL CASES FATMAX® PRO-STACK

Designed for you. The PRO-STACK modular storage cases offer you all the options, tailored for your task. Your PRO-STACK is the ideal partner to complete your tasks quickly and professionally - with an eye for robustness and user-friendliness. Each case is equipped with a sturdy coupling system to connect or disconnect the cases quickly and easily. This way you can put together your ideal combination yourself. Add the organizer for the small items and a wheel base for easy transport.

Secure storage space for small parts, accessories, hand tools and machines.

Cases with foam insert, removable dividers - depending on the model.

Robust construction with metal hinges and sturdy handles.



Trolley with telescopic handle, compatible with all cases for extra mobility.



PRO-STACK™

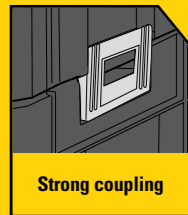

Strong coupling



Removable dividers



2 handles



Wheelbase

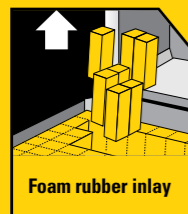

Foam rubber inlay



Removable trays



TOOLBOXES FATMAX® PRO-STACK

STANLEY® FATMAX® PRO-STACK™ COMBO

**STANLEY
FATMAX**



- Ideal for storing power tools, hand tools, small parts and accessories
- Durable side latches allow for connectivity to multiple PRO-STACK™ modules
- Features a tool box with a customisable foam insert to fit around your power tools as well as 2 additional drawers with removable dividers for the smart storage of small parts and accessories
- Anti-rust metal latches and hinges for added durability
- Carry handle for comfort and easy transportation
- Padlock eye for security on site or in your workshop or garage
- Load capacity: 30kg Shallow box, 7,5 kg Drawers
- Volume: 21,6L
- Foam insert included
- Outer Dimensions (cm WxDxH): 44 x 33.3 x 18.3
- Inner Dimension (cm WxDxH): 36.5 x 27 x 10.5

CODE	DESCRIPTION				PRICE
FMST1-71981	STANLEY® FATMAX® PRO-STACK COMBO KIT	-	4	3 253561 719813	

STANLEY® FATMAX® PRO-STACK™ ORGANISER TOP SHALLOW BOX

**STANLEY
FATMAX**



- Ideal for storing small parts, hand tools and power tools
- Durable side latches allow for connectivity to multiple PRO-STACK™ module
- Integrated shallow organiser perfect for storing small parts and accessories
- Anti-rust metal latches and hinges for added durability
- Carry handle for comfort and easy transportation
- Padlock eye for security on site or in your workshop or garage
- Load capacity: 30kg
- Volume: 14L
- Outer Dimensions (cm WxDxH): 44 x 33.3 x 18.3
- Inner Dimension (cm WxDxH): 36.5 x 27 x 10.5

CODE	DESCRIPTION				PRICE
FMST1-71967	STANLEY® FATMAX® PRO-STACK™ ORGANISER TOP SHALLOW BOX	-	4	3 253561 719677	

STANLEY® FATMAX® PRO-STACK™ CLIPBOARD

**STANLEY
FATMAX**



- Ideal work surface for site plans and documents
- Clip to other modules and carry your essential tools and important documents, all together
- Internal clipboard and storage ideal for storing personal documents, tablets and devices
- Integral LED work light for improved visibility in all working conditions
- Rubber bumpers for long lasting durability

CODE	DESCRIPTION				PRICE
FMST82721-1	STANLEY® FATMAX® PRO-STACK™ CLIPBOARD	-	4	3 253561 827211	

STANLEY® FATMAX® PRO-STACK™ SHALLOW BOX

STANLEY
FATMAX



- Ideal for storing hand tools and smaller power tools
- Durable side latches allow for connectivity to multiple PRO-STACK™ modules
- FMST1-71966 includes foam insert ideal for customising the inside of your tool box to fit around your power tools and accessories
- Anti-rust metal latches and hinges for added durability
- Carry handle for comfort and easy transportation
- Padlock eye for security on site or in your workshop or garage
- Foam insert included
- Load capacity: 30kg
- Volume: 14L
- Outer Dimensions (cm WxDxH): 44 × 33.3 × 16.2
- Inner dimensions (cm WxDxH): 36 × 27 × 10.4

CODE	DESCRIPTION				PRICE
FMST1-71966	STANLEY® FATMAX® PRO-STACK™ SHALLOW BOX	-	4	3 253561 719660	

STANLEY® FATMAX® PRO-STACK™ DEEP DRAWER

STANLEY
FATMAX



- 4 small and 2 large removeable cups for use in or outside of the organiser
- Insert the cups to store small parts and accessories or remove to store hand tools and smaller power tools
- Durable side latches allow for connectivity to multiple PRO-STACK™ modules
- Carry handle for comfort and easy transportation
- Load capacity: 7.5kg per drawer
- Volume: 9.5L
- Outer dimensions (cm WxDxH): 43 × 31.5 × 17.5
- Inner Dimension (cm WxDxH): 34.5 × 25.4 × 9.8

CODE	DESCRIPTION				PRICE
FMST1-71968	STANLEY® FATMAX® PRO-STACK™ DEEP DRAWER	-	4	3 253561 719684	

STANLEY® FATMAX® PRO-STACK™ 2 DRAWERS

STANLEY
FATMAX



- Ideal for storing small parts and accessories
- Durable side latches allow for connectivity to multiple PRO-STACK™ modules
- Features 2 drawers with removable dividers for the smart storage of parts and accessories
- Carry handle for comfort and easy transportation
- Load capacity: 7,5 kg per drawer
- Volume: 8L
- Outer dimensions (cm WxDxH): 43 × 31.5 × 17.5
- Inner Dimension (cm WxDxH): 34.7 × 25.4 × 4.5 (x2)

CODE	DESCRIPTION				PRICE
FMST1-71969	STANLEY® FATMAX® PRO-STACK™ 2 DRAWERS	-	4	3 253561 719691	

STANLEY® FATMAX® PRO-STACK™ ORGANISER

STANLEY
FATMAX

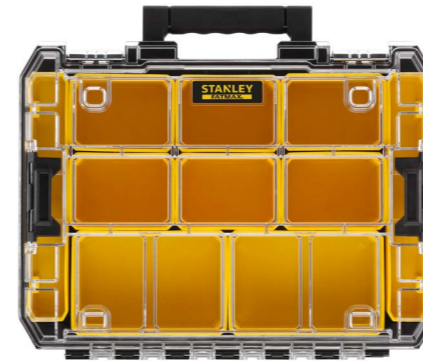

- Ideal for the smart storage of small parts, components and accessories.
- Durable side latches allow for connectivity to multiple PRO-STACK™ modules
- Includes 10 removable and stackable storage cups which can be used either integrally or stacked together for use outside the organiser
- Strong, transparent lid provides clear and un-obstructed visibility of organiser contents
- Anti-rust metal latches and hinges for added durability
- Carry handle for comfort and easy transportation.
- Padlock eye for security on site or in your workshop or garage
- Also available as a twin pack FMST82967-9
- Load capacity: 20kg
- Volume: 7.8L
- Outer Dimensions (cm WxDxH): 44 × 33.3 × 11.9
- Inner Dimension (cm WxDxH): 42.1 × 28.5 × 6.5

CODE	DESCRIPTION				PRICE
FMST82967-1	STANLEY® FATMAX® PRO-STACK™ ORGANISER	-	4	3 253561 829673	

STANLEY® FATMAX® PRO-STACK™ OPEN TOTE

STANLEY
FATMAX



- Ideal for storing your power tools, hand tools and longer tools such as levels
- Durable side latches allow for connectivity to multiple PRO-STACK™ modules
- Large opening for easy access to tote contents
- Folding handle for comfort and easy transportation.
- Carrying capacity: 20kg
- Outer dimensions (cm WxDxH): 44 × 32 × 27.5
- Inner Dimension (cm WxDxH): 36.5 × 29.0 × 26.5

CODE	DESCRIPTION				PRICE
FMST1-75794	STANLEY® FATMAX® PRO-STACK™ OPEN TOTE	-	4	3 253561 757945	

STANLEY® FATMAX® PRO-STACK™ DEEP BOX

STANLEY
FATMAX



- The perfect storage solution for larger power tools
- Durable side latches allow for connectivity to multiple PRO-STACK™ modules
- Integral removeable storage tray for hand tools and small parts
- Tray can also be removed to accommodate larger power tools
- Anti-rust metal latches and hinges for added durability
- Carry handle for comfort and easy transportation
- Padlock eye for security on site or in your workshop or garage
- Load capacity 30kg
- Volume: 22L
- Outer Dimensions (cm WxDxH): 44 × 33.3 × 30.2
- Inner Dimension (cm WxDxH): 42.0 × 27.0 × 24.7

CODE	DESCRIPTION				PRICE
FMST1-71971	FATMAX PRO-STACK VI Deep Toolbox	-	2	3 253561 719714	

STANLEY® FATMAX® PRO-STACK™ ORGANISER TOP DEEP BOX

STANLEY
FATMAX



- The perfect storage solution for small parts, hand tools and power tools
- Durable side latches allow for connectivity to multiple PRO-STACK™ modules
- Integrated shallow organiser perfect for storing small parts and accessories
- Anti-rust metal latches and hinges for added durability
- Carry handle for comfort and easy transportation
- Padlock eye for security on site or in your workshop or garage
- Capacity: 20kg
- Outer Dimensions (cm WxDxH): 44.2 x 33.8 x 32.3
- Inner Dimension (cm WxDxH): 42.0 x 27.0 x 24.7

CODE	DESCRIPTION				PRICE
FMST1-75796	FATMAX PRO-STACK Deep Toolbox - Long Handle	-	2	3 2535611757969	

STANLEY® FATMAX® PRO-STACK™ TROLLEY

STANLEY
FATMAX



- Load capacity 100k
- 360° rotating front wheels (Ø 75 mm) - with brake
- Extra large rear wheels (Ø 180 mm)
- Foldable
- Aluminum telescopic handle
- Durable side latches allow for connectivity to multiple PRO-STACK™ modules
- Dimensions (cm WxDxH): 54.6 x 59 x 104.3

CODE	DESCRIPTION				PRICE
FMST1-72363	STANLEY® FATMAX® PRO-STACK™ TROLLEY	-	2	3 2535611723636	

STANLEY® FATMAX® PRO-STACK™ MOBILE STORAGE

STANLEY
FATMAX



- Bi-material telescopic handle
- Durable 7" wheels for mobility
- Durable side latches allow for connectivity to multiple PRO-STACK™ modules
- Smooth opening thanks to specific sliding system of the handle
- The perfect storage solution for small parts, hand tools and power tools
- Modular and stackable - easy to adjust thanks to the lateral fixing elements
- Anti-rust metal latches and hinges for added durability
- Capacity: 50kg
- Outer dimensions (cm WxDxH): 51.2 x 43.5 x 100 handle up / 63.5 handle down / 38 height case
- Inner dimensions (cm WxDxH): 44 x 31 x 31.4

CODE	DESCRIPTION				PRICE
FMST1-75753	STANLEY® FATMAX® PRO-STACK™ MOBILE STORAGE	-	2	3 2535611757532	

STANLEY® FATMAX® PRO-STACK™ FOAM INSERT

STANLEY
FATMAX



- Ideal for customising the inside of your tool box to fit around your power tools and accessories
- Compatible with:
 - FMST1-71966 Shallow Box
 - FMST1-71981 Combo
- Dimensions (cm WxDxH): 43 x 30 x 7

CODE	DESCRIPTION				PRICE
FMST1-72365	STANLEY® FATMAX® PRO-STACK™ FOAM INSERT	X	2	3 2535611723650	

STANLEY® FATMAX® PRO-STACK™ CART

STANLEY
FATMAX



- Provides the ideal solution for manoeuvring
- PRO-STACK™ modules around the job site
- Durable side latches allow for connectivity to multiple PRO-STACK™ modules
- Robust lockable castors for added safety as well as smooth mobility even on rough surfaces
- Load capacity: 100kg
- Dimensions (cm WxDxH): 48.6 x 43.6 x 18.1

CODE	DESCRIPTION				PRICE
FMST1-71972	STANLEY® FATMAX® PRO-STACK™ CART	-	2	3 2535611719721	

STANLEY® FATMAX® PRO-STACK™ SOFT TOTE

STANLEY
FATMAX



- Ideal for storing and transporting power tools and hand tools
- Connect to multiple PRO-STACK™ modules for a versatile storage solution
- Aluminium carry handle for comfort and easy transportation
- Tool loops for storing long items, such as levels
- Internal dividers for maximum organisation of screwdrivers, pliers and other hand tools
- Front zip compartment for storing personal belongings
- 600 denier fabric for resistance to wear and tear
- Carrying capacity: 25kg
- Dimensions (cm WxDxH): 45 x 25 x 35

CODE	DESCRIPTION				PRICE
FMST17626-1	STANLEY® FATMAX® PRO-STACK™ SOFT TOTE	-	4	3 253561176265	

STANLEY® FATMAX® PRO-STACK™ SOFT BAG

STANLEY
FATMAX



- Ideal for storing and transporting power tools and hand tools.
- Connect to multiple PRO-STACK™ modules for a versatile storage solution
- Carry handle for comfort and easy transportation
- Multiple pockets for maximum organisation of screwdrivers, pliers and other hand tools
- Tool loops for storing long items, such as levels
- Front zip compartment for storing personal belongings
- Card holder for easy identification
- 600 denier fabric for resistance to wear and tear
- Carrying capacity: 25kg
- Dimensions (cm WxDxH): 45 x 25 x 30

CODE	DESCRIPTION				PRICE
FMST17627-1	STANLEY® FATMAX® PRO-STACK™ SOFT BAG	-	4		

STANLEY® FATMAX® PRO-STACK™ 3 MODULE MOBILE STORAGE TOWER

STANLEY
FATMAX



- Contains:
- FMST1-75502 - FATMAX PRO-STACK (No Foam) Shallow Box
- FMST1-71971 - FATMAX PRO-STACK Deep Box
- FMST1-75753 - FATMAX PRO-STACK Mobile Storage Box

CODE	DESCRIPTION				PRICE
FMST75753-9	STANLEY® FATMAX® PRO-STACK™ 3 Module Mobile Storage Tower	-	4		3253569757534

STANLEY® FATMAX® PRO-STACK™ 5 MODULE TOWER

STANLEY
FATMAX



- Contains:
- FMST1-71972 - PRO-STACK Cart
- FMST1-75502 - PRO-STACK Shallow Box (No Foam)
- FMST1-71968 - PRO-STACK Deep Drawer
- FMST1-71970 - PRO-STACK Organiser
- FMST1-71971 - PRO-STACK Deep Box

CODE	DESCRIPTION				PRICE
FMST1-80107	STANLEY® FATMAX® PRO-STACK™ 5 Module Mobile Storage Tower	-	4		3253561801075

FATMAX® PRO-STACK® KITS

STANLEY® FATMAX® PRO-STACK SOCKET SET 1/2" 26 PCS

STANLEY
FATMAX



- Transparent lid for full visibility
- Durable, robust design
- Contents:
- 1x 1/2" 120T bi-material ratchet
- 12x 1/2" sockets (6-points profile): 8 - 9 - 10 - 11 - 12 - 13 - 14 - 15 - 16 - 17 - 18 - 19 - 20 - 21 - 22 - 23 - 24 - 27 - 30 - 32 - 34 mm
- 2x 1/2" extensions: 3" - 10"
- 1x 1/2" Universal joint
- 1x 1/2" 3-WAY Adapter for Sliding T-handle
- Can be combined with PRO-STACK and TSTAK
- Size: large

CODE	DESCRIPTION				PRICE
FMMT98103-1	FATMAX PRO-STACK Socket set 1/2" 26 pcs	-	2		

STANLEY® FATMAX® PRO-STACK SOCKET SET 1/4" 37 PCS

STANLEY
FATMAX



- Transparent lid for full visibility
- Durable, robust design
- Content:
- 1x 1/4" Ratchet wrench
- 11x 1/4" sockets (6-points profile): 5 - 5.5 - 6 - 7 - 8 - 9 - 10 - 11 - 12 - 13 - 14 mm
- 1x 1/4" socket holder
- 30x 1/4" bits: Pozidriv: 1 - 2 - 3
- Phillips: 1 - 2 - 3
- Hex: 3 - 4 - 5 - 5.5 - 6 - 7
- Slotted: 3 - 4 - 5 - 6 - 7 - 8
- Tamperproof torx: 10 - 15 - 20 - 25 - 27 - 30

- Can be combined with PRO-STACK and TSTAK
- Size: small

CODE	DESCRIPTION				PRICE
FMMT19101-0	FATMAX PRO-STACK Socket set 1/4" 37 pcs	-	2		

STANLEY® FATMAX® PRO-STACK SOCKET SET 3/8" 18 PCS

STANLEY
FATMAX



- Transparent lid for full visibility
- Durable, robust design
- Contents:
- 1x 3/8" 120T bi-material ratchet
- 15x 1/4" sockets (6-points profile): 5 - 6 - 7 - 8 - 9 - 10 - 11 - 12 - 13 - 14 - 15 - 16 - 17 - 18 - 19 mm
- 1x 1/4" extensions: 3"
- 1x 1/4" Universal joint
- Can be combined with PRO-STACK and TSTAK
- Size: medium

CODE	DESCRIPTION				PRICE
FMMT98102-0	FATMAX PRO-STACK Socket set 3/8" 18 pcs	X	5		

STANLEY® FATMAX® PRO-STACK SOCKET SET 1/4" 48 PCS

STANLEY
FATMAX



- Transparent lid for full visibility
- Durable, robust design
- Contents:
 - 1x 1/4" 120T bi-material ratchet
 - 12x 1/4" sockets (6-points profile): 4 - 5 - 5.5 - 6 - 7 - 8 - 9 - 10 - 11 - 12 - 13 - 14 mm
 - 2x 1/4" extensions: 3" - 6"
 - 1x 1/4" bit holder
 - 1x 1/4" Universal joint
 - 1x 1/4" spinner
 - 30x 1/4" bits
- Can be combined with PRO-STACK and TSTAK
- Size: medium

CODE	DESCRIPTION				PRICE
FMMT98101-0	FATMAX PRO-STACK Socket set 1/4" 48 pcs	X	5	3 253560 981013	

STANLEY® FATMAX® PRO-STACK COMBINATION WRENCH SET 12 PCS

STANLEY
FATMAX



- Transparent lid for full visibility
- Durable, robust design
- Contents:
 - 12x Anti-slip combination wrenches: 6 - 7 - 8 - 9 - 10 - 11 - 12 - 13 - 14 - 15 - 16 - 17 mm
- Can be combined with PRO-STACK and TSTAK
- Size: medium

CODE	DESCRIPTION				PRICE
FMMT98104-0	FATMAX PRO-STACK Combination spanner set 12 pcs	X	4	3 253560 981044	

ORGANISERS

FATMAX® PROFESSIONAL ORGANIZER WATERPROOF (DEEP)

STANLEY
FATMAX



- 10 removable trays for small parts
- Unbreakable lid keeps all parts in place
- Stackable & lockable for transport
- Dust and water resistant: IP53
- Compatible with 1-97-517, 1-97-518, 1-97-521, 1-97-519, FMST1-75779, FMST1-75781, FMST81077-1
- Metal latches
- Outer Dimensions (cm WxDxH): 43.2 x 33 x 10.9
- Inner Dimension (cm WxDxH): 40.5 x 30 x 9.2

CODE	DESCRIPTION				PRICE
1-97-518	FATMAX Professional Organizer Waterproof (deep)	-	3	3 253561 975189	

FATMAX® PROFESSIONAL ORGANIZER (DEEP)

STANLEY
FATMAX



- 10 removable trays for small parts
- Unbreakable lid keeps all parts in place
- Stackable & lockable for transport
- Compatible with 1-97-517, 1-97-518, 1-97-521, 1-97-519, FMST1-75779, FMST1-75781, FMST81077-1
- Plastic latches
- Outer Dimensions (cm WxDxH): 43.2 x 33 x 10.9
- Inner Dimension (cm WxDxH): 40.5 x 30 x 9.2

CODE	DESCRIPTION				PRICE
1-97-521	FATMAX Professional Organizer (deep)	-	3	3 253561 975219	

FATMAX® PROFESSIONAL ORGANIZER WATERPROOF (SHALLOW)

STANLEY
FATMAX



- 10 removable trays for small parts
- Unbreakable lid keeps all parts in place
- Stackable & lockable for transport
- Dust and water resistant: IP53
- Compatible with 1-97-517, 1-97-518, 1-97-521, 1-97-519, FMST1-75779, FMST1-75781, FMST81077-1
- Metal latches
- Outer Dimensions (cm WxDxH): 43.2 x 33 x 6.4
- Inner Dimension (cm WxDxH): 40.5 x 30 x 5.5

CODE	DESCRIPTION				PRICE
1-97-517	FATMAX Professional Organizer Waterproof (shallow)	-	5	3 253561 975172	

FATMAX® PROFESSIONAL ORGANIZER (SHALLOW)

STANLEY
FATMAX



- 10 removable trays for small parts
- Unbreakable lid keeps all parts in place
- Stackable & lockable for transport
- Compatible with 1-97-517, 1-97-518, 1-97-521, 1-97-519, FMST1-75779, FMST1-75781, FMST81077-1
- Metal latches
- Outer Dimensions (cm WxDxH): 43.2 x 33 x 6.4
- Inner Dimension (cm WxDxH): 40.5 x 30 x 5.5

CODE	DESCRIPTION				PRICE
1-97-519	FATMAX Professional Organizer (shallow)	-	5	3 253561 975196	

STANLEY® FATMAX® ORGANIZER SHALLOW 1/3

STANLEY
FATMAX



- Durable and transparent polycarbonate lid
- Stackable thanks to side locking
- Compatible with all other FATMAX® organizers
- Dust and water resistant: IP53
- 8 removable trays
- Compatible with 1-97-517, 1-97-518, 1-97-521, 1-97-519, FMST1-75779, FMST1-75781, FMST81077-1
- Outer Dimensions (cm WxDxH): 43.2 x 15.2 x 6.4
- Inner Dimension (cm WxDxH): 40.5 x 11.0 x 5.3

CODE	DESCRIPTION				PRICE
FMST1-75781	FATMAX Organizer Shallow 1/3	-	4	3 253561 757815	

FATMAX® ORGANIZER WATERPROOF (SMALL)

STANLEY
FATMAX



- 6 removable trays
- Durable, transparent, watertight lid
- Stackable
- Convenient to stack 2 organizers for transport
- Outer Dimensions (cm WxDxH): 24.5 x 35.6 x 10.9
- Inner Dimension (cm WxDxH): 22.5 x 24.5 x 9.2+ 4.5 4.5 x 5.5 (x2)

CODE	DESCRIPTION				PRICE
FMST1-72378	FATMAX Small Organiser	-	4	3 253561 723780	

STANLEY® FATMAX® FLIP BIN ORGANIZER

STANLEY
FATMAX



- 12 removable compartments
- Translucent, resistant and tough polycarbonate lids
- Locking mechanism for all containers
- Side locks - the rotating tray is Compatible with FATMAX® organizers
- Extra locking for stacking
- Wall mounted
- Ergonomic handle for easy carrying comfort
- Maximum capacity: 7kg
- Compatible with 1-97-517, 1-97-518, 1-97-521, 1-97-519, FMST1-75779, FMST1-75781, FMST81077-1
- Outer Dimensions (cm WxDxH): 45 x 35.6 x 10.8
- Inner Dimension (cm WxDxH): 9 x 6 x 8 for each pocket

CODE	DESCRIPTION				PRICE
FMST81077-1	FATMAX Flip Bin Organizer	-	4	3 253561 810770	

FATMAX® ORGANIZER SHALLOW 2/3

STANLEY
FATMAX



- Durable, unbreakable, transparent polycarbonate lid
- Stackable thanks to side locking
- Compatible with all other FATMAX® organizers
- Dust and water resistant: IP53
- 16 removable trays
- Compatible with 1-97-517, 1-97-518, 1-97-521, 1-97-519, FMST1-75779, FMST1-75781, FMST81077-1
- Outer Dimensions (cm WxDxH): 43.2 x 26.7 x 6.4
- Inner Dimension (cm WxDxH): 40.5 x 23.7 x 5.3

CODE	DESCRIPTION				PRICE
FMST1-75779	FATMAX Organizer Shallow 2/3	-	6	3 253561 757792	

STANLEY® ORGANIZER PRO 8 COMPARTMENTS (DEEP)

- 8 removable, small compartments
- Comfortable handle
- Transparent lid made of hard polycarbonate
- Lid keeps parts in place in compartments
- Outer Dimensions (cm WxDxH): 42.3 x 33.3 x 10.1
- Inner dimensions (cm WxDxH): 40 x 30 x 9.6



CODE	DESCRIPTION				PRICE
1-92-749	Organizer Pro 8-compartments	-	10	3 253561 927492	

STANLEY® ORGANIZER PRO 25 COMPARTMENTS

- 25 removable, small compartments
- Comfortable handle
- Transparent lid made of hard polycarbonate
- Lid keeps parts in place in compartments
- Outer Dimensions (cm WxDxH): 42.2 x 33.4 x 5.2
- Inner Dimension (cm WxDxH): 40.5 x 30 x 4.5



CODE	DESCRIPTION				PRICE
1-92-748	Organizer Pro 25-compartments	-	20		

STANLEY® ORGANIZER SORTLEVEL

- Ergonomic handle
- Fully Compatible with the SortMaster Junior
- 12 storage compartments
- Adjustable bottom level dividers
- Transparent lid
- 2 levels - functions as a toolbox and organizer
- Can be combined with 1-97-483, STST1-75540
- Outer dimensions (cm WxDxH): 40 x 30 x 13.7
- Inner Dimension (cm WxDxH): 33 x 26 x 7.8
33 x 24.2 x 4.8



CODE	DESCRIPTION				PRICE
STST1-75540	Organizer Sortlevel	-	3		

STANLEY® SORTMASTER™ ORGANIZER

- Organizer with removable dividers: up to 1024 configurations possible
- Handy for storing tools, even hammers, and small parts
- Well locking lid
- Lid structure keeps all small parts in place
- Outer Dimensions (cm WxDxH): 44.2 x 32.7 x 9.2
- Inner Dimension (cm WxDxH): 41 x 30 x 8



CODE	DESCRIPTION				PRICE
1-94-745	Sort Master Organizer	-	4		

STANLEY® SORTMASTER ORGANIZER - STACKABLE

- Innovative stacking system
- Lateral locking for safe stacking
- Removable dividers to store handtools and small parts
- Lid keeps small parts in place
- Also available as a double-sided organizer (STST1-71197)
- STST1-70720 outer dimension (cm WxDxH): 29.7 x 7.1 x 22.4
inner dimension (cm WxDxH): 26.5 x 19 x 5.9



CODE	DESCRIPTION				PRICE
STST1-70720	SortMaster Organizer Light Stackable	-	6		
STST1-71197	SortMaster Organizer Light Stackable - double	-	12		

STANLEY® SORTMASTER™ ORGANIZER JUNIOR

- Organizer with removable dividers up to 512 configurations possible
- Lid structure keeps small parts in place
- Stackable organizer (for transport up to 3 in 1)
- Can be combined with 1-97-483, STST1-75540
- Outer Dimensions (cm WxDxH): 37.5 x 29 x 6.7
- Inner Dimension (cm WxDxH): 34.3 x 26.4 x 6



CODE	DESCRIPTION				PRICE
1-97-483	Sortmaster Organizer Junior	-	6		

STANLEY® ORGANIZER CLASSIC

- Convenient, lightweight plastic toolbox
- Transparent lid
- Comfortable handle
- 1-92-762: Movable dividers for compartments size adjustment
- 1-92-761 outer dimensions (cm WxDxH): 34 x 5.7 x 26
- 1-92-762 outer dimensions (cm WxDxH): 43 x 9 x 32.5



CODE	DESCRIPTION				PRICE
1-92-761	Organizer 14-compartments	-	8		
1-92-762	Organizer 25 compartments	-	8		

STANLEY® ORGANIZER 3 IN 1



- Added value of 3 in 1, Hand tools, power tools and accessories - 3 in 1
- Full opening structure simultaneous access to content of 3 storage parts at once
- Movable dividers which provide high customization for small for small parts and larger hand tools and power tools
- Inner Tote - Built in tote for large hand tools organization
- Robust built in handle unique carriage of tools in a secured closed case
- Outer Dimensions (cm WxDxH): 42.5 x 31.6 x 23.4
- Inner Dimension (cm WxDxH): 41 x 16 x 9
 - 41 x 8 x 9 (x2)
 - 13 x 4.5 x 9 (x2)
 - 39 x 20 x 7

CODE	DESCRIPTION				PRICE
STST1-71963	Organizer 3in1	-	4		

STANLEY® ESSENTIAL COMPARTMENT ORGANISER - BASIC



- Transparent lid
- Removable dividers to store both small and larger parts
- Comfortable handle
- Embossed ruler in the lid for quick and easy on-site measurements
- STST81679-1 outer dimension (cm WxDxH): 21 x 3.5 x 11.5
inner dimension (cm WxDxH): 20.3 x 9.6 x 2.5
- STST81680-1 outer dimension (cm WxDxH): 28 x 4.5 x 19.5
inner dimension (cm WxDxH): 26.5 x 17.0 x 4.0
- STST81681-1 Outer Dimension (cm WxDxH): 35.7 x 4.8 x 22.9
Inner Dimension (cm WxDxH): 34.7 x 21.0 x 4.5

CODE	DESCRIPTION				PRICE
STST81679-1	10 Compartment Organiser	-	36		
STST81680-1	17 Compartment Organiser	-	18		
STST81681-1	22 Compartment Organiser	-	8		

STANLEY® DRAWER UNITS ESSENTIAL



- Organize small parts and accessories
- Transparent removable drawers for easy access and clearly visible
- Made of polypropylene for extra durability
- Lightweight and compact
- STST40710-1 outer size (cm WxDxH): 21.5 x 15.1 x 19
- STST40711-1 Outer Dimension (cm WxDxH): 23.7 x 18 x 30.2
- STST40712-1 Outer Dimension (cm WxDxH): 34.1 x 25 x 32.2

CODE	DESCRIPTION				PRICE
STST40710-1	Drawer unit Small Essential	-	1		
STST40711-1	Drawer unit Medium Essential	-	1		
STST40712-1	Drawer unit Large Essential	-	1		

NEW

STANLEY® STORAGE BOX WITH COMPARTMENTS



- Ideal for storing spare parts and accessories
- Flexible, transparent polypropylene drawers
- High-density polypropylene base structure
- Can be wall-mounted
- Combinable (1-93-981, -1-93-980, 1-93-978, 1-97-524 and 1-97-525) – easily stackable to form a fully modular storage system
- 1-93-978 outer dimensions (cm WxDxH): 36.5 x 15.5 x 21.3
- 1-93-980 outer dimensions (cm WxDxH): 36.5 x 15.5 x 22.5
- 1-93-981 outer dimensions (cm WxDxH): 43.5 x 15.5 x 36.7

CODE	DESCRIPTION				PRICE
1-93-978	Storage box with drawers 9 compartments	-	10		
1-93-980	Storage box with drawers 30 compartments	-	10		
1-93-981	Storage box with drawers 39 compartments	-	6		
1-97-524	Dividers small - x10	-	750		
1-97-525	Dividers large - x10	-	250		

STANLEY® ESSENTIAL STORAGE BIN



- Interlocking storage trays in 4 sizes
- Ideal for storing small parts (industry, workshop or DIY)
- 92-715/716: Stackable
- Dimensions (cm WxDxH):
 - N°2: Outdoor 11.9 x 16.5 x 7.5 / Indoor 12.5 x 8 x 4 (Front) 12.5 x 8 x 7 (Rear)
 - N°3: Outer 17.5 x 24 x 12.6 / Inner 12 x 20 x 6.2 (Front) 12 x 20 x 12.4 (Rear)
 - N°4: Outer 23 x 32.9 x 15.5 / Inner 25.6 x 16 x 7.8 (Front) 25.6 x 16 x 5.3 (Rear)
 - N°5: Outer 31.5 x 45 x 17.9 / Inner 42 x 26 x 8.5 (front) 42 x 26 x 16 (rear)
- Available in black, red and blue

CODE	DESCRIPTION				PRICE
STST82737-1	Storage bin No. 2 Blue	-	48		
STST82740-1	Storage bin No. 3 Blue	-	36		
STST82743-1	Storage bin No. 4 Blue	-	12		
STST82746-1	Storage bin No. 5 Blue	-	8		
STST82736-1	Storage bin No. 2 Red	-	48		
STST82739-1	Storage bin No. 3 Red	-	36		
STST82742-1	Storage bin No. 4 Red	-	12		
STST82745-1	Storage bin No. 5 Red	-	8		



WORKSHOP SOLUTIONS & WORK FACILITATION

An organized workshop is an efficient workshop. Outfit yours with tried and true STANLEY® workshop storage solutions.

Get sawing, scaffolding, and painting support. High-endurance STANLEY® sawhorses and workbenches are designed to hold up under worksite demands.

METAL CABINETS - READY TO ASSEMBLE

HIGH CUPBOARD 2 DOORS RTA



- Heavy duty steel construction
- Three adjustable shelves with a capacity of 68 kg
- Lockable with key (2 keys included)
- Four adjustable leveling feet: Ensure that the cabinet is set level, even on uneven floors
- Total capacity: 295 kg
- Dimensions (W×H×D): 93 × 183 × 46 cm
- Weight: 46 kg

CODE	DESCRIPTION				PRICE
STST97957-1	High cabinet 2 doors	-	1	3 2 5 3 5 6 1 1 9 7 9 5 7 6	

TOOL CABINET 26" RTA



- Total load capacity: 297 kg
- Drawers with load capacity up to 45 kg
- 6 lockable drawers with ball bearings and soft close
- Dimensions (W×H×D): 67.6 × 84.3 × 46 cm (wheels included)
- Top surface equipped with rubber mat
- 4"×2" lockable and swivel wheels
- Handle (mounted on the left or right)
- Can be combined with the RTA system and TRACKWALL® system
- Supplied with Track Rail accessory (406 × 17 × 59 mm, capacity 10 kg) (left or right mounted)

CODE	DESCRIPTION				PRICE
STST98182-1	Tool Cabinet 26" RTA	-	1	3 2 5 3 5 6 1 1 9 8 1 8 2 1	

WALL CABINET 2 DOORS RTA



- Heavy duty steel construction
- One shelf with a capacity of 22.5 kg
- Lockable with key (2 keys included)
- Can be mounted on all walls or the TRACKWALL® system
- Total capacity: 45 kg
- Dimensions (W×H×D): 76.5 × 78.7 × 30 cm
- Weight: 17 kg

CODE	DESCRIPTION				PRICE
STST97598-1	Wall cabinet 2 doors	-	1	3 2 5 3 5 6 1 1 9 7 5 9 8 1	

WALL CABINET 1 DOOR RTA



- Heavy duty steel construction
- Lockable with key (2 keys included)
- Door with gas springs
- Can be mounted on all walls or the TRACKWALL® system
- Total capacity: 22 kg
- Dimensions (W×H×D): 77.5 × 50 × 30.5 cm
- Weight: 12 kg

CODE	DESCRIPTION				PRICE
STST97599-1	Wall cabinet 1 door	-	1		

LOW CABINET 2 DOORS RTA



- Heavy duty steel construction
- One shelf with a capacity of 68 kg
- Lockable with key (2 keys included)
- Rubber wood top thickness 20 mm
- Total capacity: 250 kg
- Dimensions (W×H×D): 77.5 × 87 × 46 cm
- Weight: 24.5 kg

CODE	DESCRIPTION				PRICE
STST97595-1	Low Cabinet 2 doors	-	1		

WORKBENCH RTA



- Carrying capacity up to 500 kg
- 25mm thick rubberwood work surface
- Robust steel frame, ready for assembly
- Place for low cabinet and/or Tool Cabinet of the RTA system
- Can be combined with the RTA system
- Dimensions (W×H×D): 150 × 60 × 96 cm

CODE	DESCRIPTION				PRICE
STST97998-1	Workbench RTA	-	1		

“ Definitely recommended. Good price and lots of space. ”

Sander, car mechanic

9.0/10

Reevoo Verified



TOOL CABINETS

TOOL CABINET WITH 7 DRAWERS



- 2 medium and 5 shallow drawers for organizing your tools and accessories
- Durable worktop ideal for storing small parts and accessories
- Worktop with integrated handles
- Durable drawers with ball bearing slides, also for storing heavier tools
- With non-slip drawer lining
- Lockable with key on the side for safe storage of the tool
- Lockable castors for easy mobility and safety
- Made in France
- Load capacity: 300kg total, 20kg per drawer
- Dimensions: L73.5 x H89 x W51.5 cm

CODE	DESCRIPTION				PRICE
STST74305-1	Tool Cabinet with 5 drawers	-	1	3253561743054	
STST74306-1	Tool Cabinet with 7 drawers	-	1	3253561743061	

NEW

TOOL CABINET 26" RTA



- Total load capacity: 297 kg
- Drawers with load capacity up to 45 kg
- 6 lockable drawers with ball bearings and soft close
- Dimensions (LxHxW): 67.6 x 84.3 x 46 cm (wheels included)
- Top surface equipped with work mat
- 4" x 2" lockable and swivel wheels
- Handle (mounted on the left or right)
- Can be combined with the RTA system and TRACKWALL® system
- Supplied with Track Rail accessory (406 x 17 x 59 mm, capacity 10 kg) (left or right mounted)

CODE	DESCRIPTION				PRICE
STST98182-1	Tool Cabinet 26" RTA	-	1	3253561981821	

TOOL CABINET 27"



- 2 fixed, 2 swiveling casters with full breaking capabilities and chrome caster hub cap
- Heavy duty ball bearing slides for the drawers- quality drawer sliding system with better grip and locking mechanism
- 23kg storage capacity
- 6mm top mat on top of cabinet
- 272kg caster capacity
- Dimensions of caster: 127x50mm
- Top drawer: 58x39x8cm
- Other drawers: 58x39x14cm

CODE	DESCRIPTION				PRICE
STMT1-75063	Tool Cabinet 27"	-	1	3253561750632	
STMT1-75062	Top Top Chest 22"	-	1	3253561750625	

TRACKWALL® HANGING SYSTEM

STANLEY TRACKWALL® KITS



- Content STST22000-1 :
 - 2x TRACKWALL® wall panel
 - 2x TRACKWALL® S hook
 - 1x TRACKWALL® end cap 4 pieces
 - 2x TRACKWALL® universal hook medium
 - 1x TRACKWALL® universal hook large
 - 1x TRACKWALL® hook for garden tools
 - 1x TRACKWALL® hook assortment small 8 pcs
- Content STST22001-1 :
 - 1x TRACKWALL® wall panel
 - 1x TRACKWALL® S hook
 - 1x TRACKWALL® universal hook medium
 - 1x TRACKWALL® universal hook large
 - 1x TRACKWALL® hook assortment small 8 pcs

CODE	DESCRIPTION				PRICE
STST22000-1	STANLEY TRACKWALL Starter Set - 20 pcs	X	1	3253561220005	
STST22001-1	STANLEY TRACKWALL Set - 12 pcs	X	1	3253561220012	

STANLEY TRACKWALL® WALL PANEL

- Size: 121 x 2.5 x 14 cm
- Weight: 1.6 kg
- Capacity: 130 kg



CODE	DESCRIPTION				PRICE
STST82602-1	STANLEY TRACKWALL Wall panel	X	6	3253561826023	

STANLEY TRACKWALL® S HOOK



- Ideal for hanging up tools such as brushes, shovels, etc...
- Easy to attach to the TRACKWALL® panel without tools
- Capacity: 11 kg

CODE	DESCRIPTION				PRICE
STST82605-1	STANLEY TRACKWALL S Hook	X	24	3253561826054	

STANLEY TRACKWALL® DOUBLE HOOK



- Ideal for hanging up all kinds of tools, but also for jackets or the like
- Easy to attach to the TRACKWALL® panel without tools
- Capacity: 11 kg

CODE	DESCRIPTION				PRICE
STST82606-1	STANLEY TRACKWALL Double Hook	X	24	3253561826061	

STANLEY TRACKWALL® UNIVERSAL HOOK MEDIUM



- Ideal for hanging up all kinds of tools, but also for jackets or the like
- Easy to attach to the TRACKWALL® panel without tools
- Capacity: 22.5 kg

CODE	DESCRIPTION				PRICE
STST82607-1	STANLEY TRACKWALL Universal Hook Medium	X	24		

STANLEY TRACKWALL® UNIVERSAL HOOK LARGE



- Ideal for hanging all kinds of larger tools such as leaf blowers, folding chairs, etc...
- Easy to attach to the TRACKWALL® panel without tools
- Capacity: 22.5 kg

CODE	DESCRIPTION				PRICE
STST82608-1	STANLEY TRACKWALL Universal Hook Large	X	24		

STANLEY TRACKWALL® GARDEN TOOL HOOK



- Specially designed to hang larger (garden) tools
- Easy to attach to the TRACKWALL® panel without tools
- Capacity: 22.5 kg

CODE	DESCRIPTION				PRICE
STST82609-1	STANLEY TRACKWALL Hook for Garden Tools	X	24		

STANLEY TRACKWALL® HOOK LARGE



- Extra large hook, ideal for storing garden hose or extension cord
- Easy to attach to the TRACKWALL® panel without tools
- Capacity: 13.5 kg
- Dimensions: 19.5 × 21.5 × 13.5 cm

CODE	DESCRIPTION				PRICE
STST82604-1	STANLEY TRACKWALL Hook Large	X	24		

STANLEY TRACKWALL® LADDER HOOK



- Ideal for hanging a ladder, horizontally (2 pieces) or vertically
- Easy to attach to the TRACKWALL® panel without tools
- Special design makes it possible to secure the ladder with a rope/elastic
- Capacity: 22.5 kg
- Dimensions: 10 × 24 × 33 cm

CODE	DESCRIPTION				PRICE
STST82614-1	STANLEY TRACKWALL Ladder hook	X	16		

STANLEY TRACKWALL® BASKET



- Metal wire basket
- Easy to attach to the TRACKWALL® panel without tools
- Capacity: 16 kg
- Weight: 0.58 kg
- Dimensions: 28 × 17 × 16 cm

CODE	DESCRIPTION				PRICE
STST82603-1	STANLEY TRACKWALL Basket	X	8		

STANLEY TRACKWALL® BICYCLE HOOK HORIZONTAL



- Ideal for hanging a bicycle (2 hooks), but also for hanging a garden hose or extension cord
- Hook can be folded when not in use
- Easy to attach to the TRACKWALL® panel without tools
- Capacity: 11 kg
- Dimensions: 9 × 40.5 × 10 cm

CODE	DESCRIPTION				PRICE
STST82615-1	STANLEY TRACKWALL Bicycle Hook Horizontal	X	24		

STANLEY TRACKWALL® BICYCLE HOOK VERTICAL



- Ideal for hanging a bicycle in a vertical position
- Easy to attach to the TRACKWALL® panel without tools
- Capacity: 16 kg
- Dimensions: 12 × 14 × 22.5 cm

CODE	DESCRIPTION				PRICE
STST82616-1	STANLEY TRACKWALL Bicycle Hook Vertical	X	24		

STANLEY TRACKWALL® HOOK ASSORTMENT SMALL - 8 PIECES



- Ideal for hanging small tools
- Assortment of small hooks
- Easy to attach to the TRACKWALL® panel without tools
- Capacity per hook: 2.5 kg

CODE	DESCRIPTION				PRICE
STST82617-1	STANLEY TRACKWALL Hook assortment small - 8 pcs	X	24		

STANLEY TRACKWALL® SHELF CARRIER - 1 PIECE



- 2 carriers for 1 shelf, 3 carriers can carry 2 shelves
- Can also be used with 25.5 cm deep wooden shelf
- Easy to attach to the TRACKWALL® panel without tools
- Carrier for TRACKWALL® shelf
- Capacity (per 2 hooks): 22.5 kg

CODE	DESCRIPTION				PRICE
STST82612-1	STANLEY TRACKWALL Shelf carrier - 1 piece	X	24		

STANLEY TRACKWALL® WIRE SHELF



- Dimensions: 57 × 26 × 3 cm
- To be used with the TRACKWALL® shelf supports (STST82612-1) (not included)
- 2 carriers for 1 shelf, 3 carriers can carry 2 shelves
- Capacity: 22.5 kg

CODE	DESCRIPTION				PRICE
STST82613-1	STANLEY TRACKWALL Wire shelf	X	16		

STANLEY TRACKWALL® CONNECTOR - 4 PCS



- Contents: 4 pieces
- Use these connectors to connect different TRACKWALL® wall panels
- 4 connectors can connect up to 5 panels

CODE	DESCRIPTION				PRICE
STST82610-1	STANLEY TRACKWALL Connector - 4 pcs	X	24		

STANLEY TRACKWALL® END CAP - PACK OF 4



- Provides a neat finish to the ends of the TRACKWALL® wall panels
- Content 4 pieces

CODE	DESCRIPTION				PRICE
STST82611-1	STANLEY TRACKWALL End Cap - Pack of 4	X	24		



SAWHORSES Optimal user comfort

We realize how important a good work surface is and therefore have a wide range of robust and easy to move sawhorses: from simple folding sawhorses, fully adjustable sawhorses in height and width, to telescopic sawhorses with individually adjustable legs.

WORKBENCHES & SAWHORSES

FATMAX® FOLDABLE WORKBENCH

STANLEY
FATMAX



- Fold-out metal legs
- Easy to set up: flips open in seconds
- Large work surface: 85 × 60cm
- Compatible with different size hand clamps
- Suitable for horizontal and vertical clamping
- Handle for easy transport and storage
- Capacity: 450kg
- Height: 80 cm

CODE	DESCRIPTION				PRICE
FMST1-75672	FATMAX Foldable Workbench	-	2		

FOLDABLE WORKBENCH ESSENTIAL



- Versatile, portable and large work surface
- Design worktop for use with clamps in different positions and for different applications
- Foldable worktop for compact storage
- Integrated accessory tray for small parts and accessories
- Automatic and durable worktop locking mechanism for extra safety
- With latches to connect several STANLEY® Foldable work tables together to increase the work surface
- To be used in combination with STANLEY® metal sawhorse (STST81337-1) (same height)
- Handle for easy transport
- Load capacity: 320kg
- Dimensions: 85 × 30.3 × 16 cm folded, 85 × 59.3 × 73.9 cm open
- Weight: 6.7kg

CODE	DESCRIPTION				PRICE
STST83492-1	Foldable Workbench Essential	-	2		3253561834929

FATMAX® FOLDABLE SAWHORSE (PAIR)

STANLEY
FATMAX



- Suitable for use in combination with FATMAX® clamps
- Fold-out handle
- Convenient to store or transport: foldable legs and side lock to transport both sawhorses together
- Metal legs and frame for a robust and sturdy workbench
- Rubber work surface prevents work material from sliding away
- Grooves holds timber in place - 38 mm slots (x4)
- Capacity: 900kg (per pair)
- Dimensions (cm): 111.7 × 26 × 12 (folded)
111.7 × 82.8 × 12 (open)

CODE	DESCRIPTION				PRICE
FMST1-75763	FATMAX Foldable Sawhorse (pair)	-	2		

FOLDABLE SAWHORSE (PAIR)



- Light and convenient for transportation
- Compact - 2 buildable sawhorses can be locked together
- Shoulder belt
- Aluminum legs
- Capacity: 340 kg (per pair)
- Dimensions (cm): 109 × 20 × 11 (folded)
109 × 78 × 44 (open)

CODE	DESCRIPTION				PRICE
1-97-475	Foldable sawhorse (pair)	-	2		

2-WAY ADJUSTABLE SAWHORSE (PAIR)



- Adjustable height and width
- Robust polypropylene structure
- Innovative ergonomic adjustment mechanism: both height and width
- Light weight for transportation
- Work safely thanks to non-slip feet
- Equipped with a tool tray for storing hand tools
- Capacity: 450 kg (per pair)
- Dimensions (cm): 71 × 76.5 × 14.8 (folded)
71-115 × 76.5-89 × 42.5 (open)

CODE	DESCRIPTION				PRICE
STST1-70559	2-way adjustable sawhorse (pair)	-	2		

FOLDABLE V-GROOVE SAWHORSE (PAIR)



- Robust design
- Light weight for transportation
- Grooves holds timber in place - 38 mm slots (x4)
- Work safely thanks to non-slip feet
- Equipped with cable holder
- Equipped with tool tray for storing hand tools
- Capacity: 450 kg (per pair)
- Dimensions (cm): 69 × 81 × 11 (folded)
69 × 79.5 × 37 (open)

CODE	DESCRIPTION				PRICE
STST1-70713	Foldable saw book (pair)	-	4		

ESSENTIAL METAL SAWHORSE (PAIR)



- Folding Legs - Allows the trestle to be set up and folded quickly, is compact to store and easy to carry.
- Metal legs - sturdy and stable
- Metal bar - for clamping applications
- Set of Two - Allows two trestles to be carried with one hand
- Non-slip rubber layer - For friction on the surface during cutting
- Capacity: 450 kg (per pair)
- Dimensions (cm): 79.5 × 21 × 9.5 (folded)
79.5 × 73.5 × 41.5 (open)

CODE	DESCRIPTION				PRICE
STST81337-1	Essential Metal Sawhorse (pair)	-	3		

STANLEY® 2-IN-1 WORKBENCH



- The V-groove ensures effortless cutting of pipes and round materials, while the feet are protected with non-slip rubber for more safety
- When folded flat, it is easy to store and does not take up much space
- Width of the work surface 541 mm
- Double working height 620 - 800 mm
- Load capacity 250 kg, suitable for even the most demanding applications
- Dimensions 83 x 61 x 21.8 cm

CODE	DESCRIPTION				PRICE
STST83800-1	Workbench 2-in-1	-	1		3253561838002

FOLDABLE SAW BOOK JUNIOR (PAIR)



- Lightweight Design: Folds completely flat for easy transport and storage
- Grooves holds timber in place - 38 mm slots (x4)
- 2 units can be used as a portable work table
- Non-slip rubber feet keep the sawhorses stable
- Capacity: 362 kg (per pair)
- Dimensions (cm): 57.1 × 81 × 11 (folded)
57.1 × 79.5 × 37 (open)

CODE	DESCRIPTION				PRICE
STST1-70355	Folding Sawhorse Junior (pair)	-	4		

STANLEY® 2-IN-1 WORKBENCH



- 250kg capacity - workbench supports up to 250kg.
- Dual heights: 595mm and 775mm for versatile use as a workbench, tool stand, vice or sawhorse.
- Supplied with a third removable panel to convert from a vice to spacious workbench in one easy move.
- Swivels pegs - Enable larger or awkward shaped materials to be held firmly in place and helps to increase clamping force.
- Anti slip rubber feet - for added safety
- The V-groove ensures effortless cutting of pipes and round materials, while the feet are protected with non-slip rubber for more safety

CODE	DESCRIPTION				PRICE
STST83400-1	STANLEY® 2-in-1 Workbench & Vice	-	1		3253561834004

FATMAX® EXTENDABLE METAL SAWHORSE (PAIR)

STANLEY
FATMAX



- Adjustable height
- 4 metal legs for extra heavy load, feet are individually adjustable
- Non-slip pads on top and legs to ensure stability
- Grooves holds timber in place - 38 mm slots (x4)
- Easy to store
- Space-saving design
- Maximum capacity: 1350 kg per pair
- Dimensions (cm): 69 × 83.1 × 11 (folded)
69 × 81-100 × 39.5-48 (open)

CODE	DESCRIPTION				PRICE
1-92-980	FATMAX Extendable Metal Sawhorse (pair)	-	2		

STANLEY[®]

SERVICE 

ONLINE SERVICE

www.2helpu.com

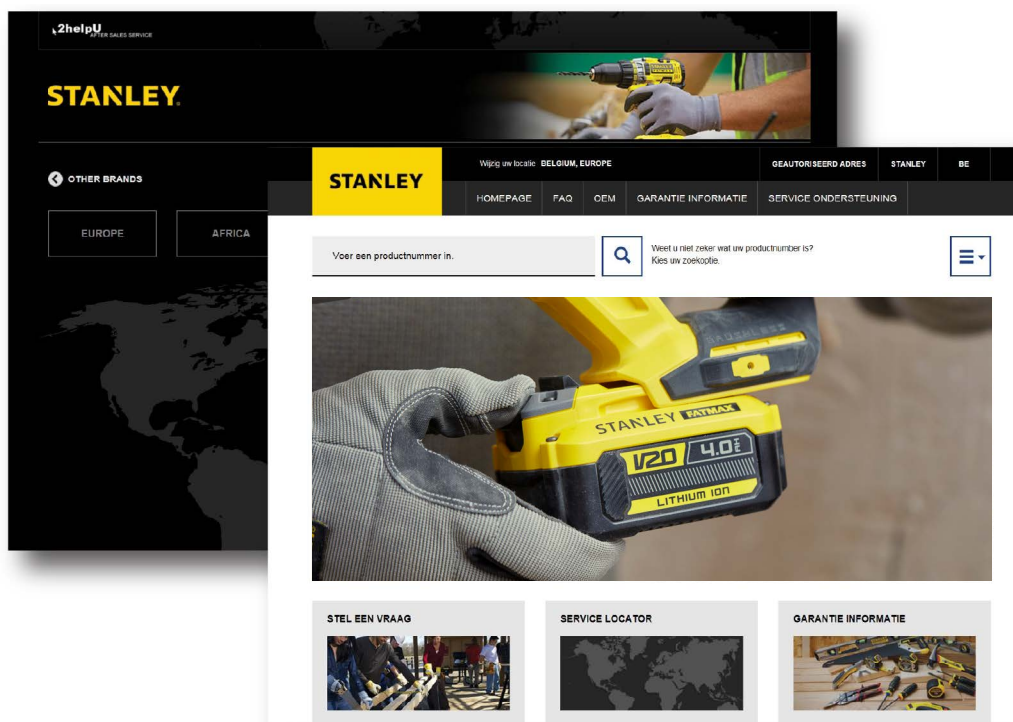

VISIT THE STANLEY SERVICE WEBSITE FOR:

1. THE WARRANTY POLICY
2. FREQUENTLY ASKED QUESTIONS
3. UP-TO-DATE SPARE PARTS INFORMATION
4. PARTS DRAWINGS AND PARTS LISTS OF STANLEY AND STANLEY FATMAX[®] PRODUCTS



STANLEY®

STANLEY BLACK & DECKER AB

Box 94

431 35 Mölndal

Sverige

Tel: +4631-68 60 00

www.STANLEYWORKS.no

www.STANLEYWORKS.se

www.STANLEYWORKS.dk

www.STANLEYWORKS.fi

