

i-CON VARIO 2 MK2 i-CON VARIO 2P MK2 i-CON VARIO 2HP MK2 i-CON VARIO 2X MK2

Soldering & Desoldering Station



Operating Instructions

Ersa GmbH
Leonhard-Karl-Str. 24
97877 Wertheim/Germany
www.ersa.com

Phone +49 9342/800-0
Fax +49 9342/800-127
service.tools@kurtzersa.de

 **kurtz ersa**

Table of Contents

1. Introduction	5
2. Technical data.....	6
3. Concerning your safety	9
3.1 Safety instructions	9
3.2 Intended use	11
3.3 National and international regulations	11
4. Transport, storage, waste disposal	12
4.1 Transport and storage	12
5. Commissioning	13
5.1 Before start-up	13
5.2 Description.....	13
5.3 Switching on the first time.....	14
6. Functional description	16
6.1 Operation.....	16
6.2 The work mode.....	16
6.2.1 microSD-card.....	17
6.2.1.1 Insert microSD-card	17
6.2.2 Software version	17
6.2.3 Activating tools.....	17
6.2.4 Working with the i-TOOL AIR S	18
6.2.5 Working with the CHIP TOOL VARIO.....	20
6.2.6 Working with the X-TOOL VARIO	21
6.2.6.1 Before first commissioning	21
6.2.6.2 Selection of the right desoldering temperature.....	21
6.2.6.3 Desoldering with X-TOOL VARIO	22
6.2.6.4 Maintenance and servicing X-TOOL VARIO.....	22
6.2.7 Working with the VAC PEN	24
6.2.8 Setting heating stage of heating plate.....	24
6.2.9 Working with the heating plate	25
6.2.9.1 Power values of the heating plate.....	25

6.3	Parameter mode.....	26
6.3.1	i-SET TOOL.....	27
6.3.2	Target temperature.....	27
6.3.3	Min. temp. / Max. temp.	28
6.3.4	Calibration temperature.....	28
6.3.5	Setting the size of the hot air nozzle i-TOOL AIR S.....	28
6.3.6	Tip offset.....	29
6.3.7	Calibrating the i-CON VARIO 2.....	30
6.3.8	Determining the calibration temperature.....	30
6.3.9	Energy.....	31
6.3.10	Standby period.....	31
6.3.11	Standby temperature.....	31
6.4	Configuration mode.....	32
6.4.1	Temperature window.....	32
6.4.2	Process alarm.....	33
6.4.3	Password protection.....	33
6.4.4	Setting the password.....	33
6.4.5	Changing the password.....	34
6.4.6	Password forgotten.....	34
6.4.7	Temperature unit.....	35
6.4.8	Language selection.....	35
6.4.9	Adjustable shut-down function (idle state).....	35
6.4.10	Heating plate.....	36
	6.4.10.1 Connecting heating plate to soldering station.....	36
	6.4.10.2 Activating the heating plate.....	36
6.4.11	Activating the soldering fume extraction.....	36
6.4.12	Activating VAC PEN Mode.....	36
6.5	Factory settings (“Default”).....	37
6.6	Contrast.....	38
6.7	Changing soldering tips.....	39
6.7.1	i-TOOL.....	39
6.7.2	Changing the hot air nozzle i-TOOL AIR S.....	40
6.7.3	Changing desoldering tips of X-TOOL VARIO.....	41
6.7.4	Replacing the CHIP TOOL VARIO heating element.....	41
6.7.5	Replacing the i-TOOL HP tip.....	41
6.8	Changing a heating element.....	42
6.8.1	Changing the i-TOOL heating element.....	42
6.8.2	Changing the i-TOOL AIR S heating element.....	42

6.8.3	Changing the CHIP TOOL heating element	42
6.8.4	Changing the CHIP TOOL VARIO heating element	43
6.8.5	Replacing the X-TOOL VARIO heating head	43
6.8.6	Changing the i-TOOL HP heating element	44
6.9	Changing the prefilter	44
6.10	Sensitive components.....	45
7.	Error diagnosis	46
7.1	General errors.....	46
7.2	Other faults.....	46
7.3	Parameter changes not possible.....	46
7.4	Error Messages	47
8.	Maintenance and cleaning.....	48
8.1	Important service work	48
8.2	Cleaning	48
8.3	Replacing the air filter.....	48
9.	Spare parts, accessories.....	49
9.1	Desoldering tips CHIP TOOL VARIO (one pair each).....	51
10.	Warranty	52

1. Introduction

Up to two soldering and desoldering tools (hereafter referred to as “soldering tool”) can be connected to the supply unit and operated together. The connected soldering tools can be activated by simply pressing the i-OP rotary encoder. Some of the soldering tools, such as e.g. the i-TOOL, the X-TOOL VARIO, or the CHIP TOOL VARIO, are automatically activated when they are taken from the holder.

The i-CON VARIO 2 can be operated with a vast variety of different soldering tools. Besides the i-TOOL can also connect the CHIP TOOL and CHIP TOOL VARIO for desoldering very small SMT-components and the desoldering tool X-TOOL VARIO. Apart from an optional vacuum connection for desoldering THT-component, the station is also equipped with a powerful air compressor for work with the i-TOOL AIR S.

The possibility of being able to use the well established soldering tools, TECH TOOL and MICRO TOOL and the connectivity for future soldering tools round off the high flexibility of this station. With its vast variety of functions, the high speed and regulating accuracy this soldering station is most suitable for use in manufacturing processed with high quality requirements.

The soldering station comes with two serial interfaces and a USB-port. The station is also equipped with ports for connecting to a PC, other control units, a soldering fume extractor or even a heating plate. The use of a microSD-card or the i-SET TOOL offers the additional possibility to save the different settings of the station. Furthermore, this way the saved data can not only be transferred back to the soldering station, but also to other i-CON VARIO 4 stations.

2. Technical data

Soldering station i-CON VARIO 2	
Designation	Value
Dimensions approx.	180 mm x 280 mm x 115 mm
Weight	Approx. 6 kg
Voltage	220 – 240 VAC
Mains frequency	50 Hz
Fuse (slow blowing)	3.15 A
Secondary voltage	24 VAC
Maximum short-term heating power	350 W
Medium power	160 W
Class of protection	I
Permissible ambient temperature	0 – 40 °C
Temperature range (stepless)	150 – 450 °C (50 – 550°C i-TOOL AIR S) 300 – 842 °F (122 – 1020°F i-TOOL AIR S)
Regulating fluctuations in idle state	< ± 2 °C
Ohmic resistance between soldering tip and ground	< 2 Ohm
Leakage voltage soldering tip to ground	< 2 mV _{eff}
Equipotential bonding	4 mm
Air supply (depending on model)	Internal, blow-of air 2 – 20 l/min (± 5%), vacuum up to 700 mbar
Interface on front face	1 x microSD-card
Interface on rear side	Ersa soldering fume extraction, pre-heating plate IRHP100, ready signal, standby signal, USB 2.0, equipotential bonding 4 mm bushing
Control technology (tool-dependent)	SENSOTRONIC (PID-characteristic), RESISTRONIC
Function display	LC-Display, blue
Supply cable 2 m, PVC, with appliance socket	
Single-button operation via incremental encoder (i-OP)	
Anti-static surface, especially suitable for use in ESD areas.	
Acc. to MIL-SPEC/ESA-Standard	
VDE, EMC-tested	
Conformity	CE
Two tools operable at the same time	
Connectible soldering and desoldering tools (depending on model): i-TOOL, i-TOOL AIR S, CHIP TOOL, CHIP TOOL VARIO, X-TOOL VARIO, TECH TOOL, MICRO TOOL, i-SET TOOL, i-TOOL HP	

Soldering iron i-TOOL	
Designation	Value
Operating voltage	24 VAC
Maximum heat output	150 W
Mean heating power	80 W
Heating up time to 350 °C / 662 °F	Approx. 10 s
Temperature range	150 – 450 °C
Temperature fluctuations in idle state	Less than ±2 °C/±4 °F
Weight without power cable	Approx. 30 g
Miscellaneous	
Power cable 1.5 m, highly flexible, heat resistant, antistatic	
Antistatic design acc. to MIL-SPEC/ESA-standard	
Identification and standby function integrated in the handle	

Soldering iron Tool AIR S	
Designation	Value
Operating voltage	24 VAC
Maximum heat output	200 W
Temperature range	50 °C – 550 °C
Temperature sensor	K-type thermocouple
Air supply	Blowing air up to 20 l/min, adjustable on the tool
Weight (without power cable)	Approx. 90 g
Dimensions (without hose)	Handle approx. 220 mm
Diameter	Max. 25 mm
Power cable	Approx. 1.5 m
Hot air nozzle	1.7 mm, 2 mm, 3.5 mm, 4 mm, 6 mm
Design	Antistatic

Desoldering iron CHIP TOOL	
Designation	Value
Operating voltage	24 VAC
Maximum heat output	PTC 2 x 30 W/280 °C, 2 x 20 W/350 °C
Heat-up time	Depending on soldering application
Temperature range	150 – 450 °C
Temperature sensor	PTC
Weight (without power cable)	Approx. 75 g
Power cable	1.2 m, highly flexible, heat resistant, antistatic
Design	Antistatic

Desoldering CHIP TOOL VARIO	
Designation	Value
Operating voltage	24 VAC
Maximum heat output	80 W
Temperature range	150 °C – 450 °C
Temperature sensor	K-type thermocouple in each tip
Weight (without power cable)	Approx. 30 g
Dimensions (without power cable)	Approx. 145 mm x 45 mm x 25 mm
Power cable	Approx. 1.2 m
Design	Antistatic

Desoldering iron X-TOOL VARIO	
Designation	Value
Operating voltage	24 VAC
Heating power	150 W
Heat-up time	Approx. 35 s to 350 °C
Temperature range	150 – 450 °C
Temperature measurement	Ni-CrNi thermocouple
Start vacuum	Up to 800 mbar
Weight	Approx. 210 g incl. cable and desoldering tip
Design	Antistatic

Soldering iron i-TOOL HP	
Designation	Value
Operating voltage	24 VAC
Heating power	250 W
Heat-up time	Approx. 40 s to 380 °C
Temperature range	150 – 450 °C
Temperature measurement	Ni-CrNi thermocouple
Weight	Approx. 110 g
Design	Antistatic

Soldering iron TECH TOOL	
Designation	Value
Operating voltage	24 VAC
Output	70 W/280 °C (536 °F) – 60 W/350 °C (662 °F)
Heat up rating	130 W
Heat up time	Approx. 12 s to 280 °C
Temperature range	150 – 450 °C
Temperature sensor	Ni-CrNi thermocouple
Cable	1,5 m ultra-flexible, heat-resistant, antistatic
Weight (without cable)	Approx. 50 g
Design	Antistatic

Soldering iron MICRO TOOL	
Designation	Value
Operating voltage	24 VAC
Output	30 W/280 °C (536 °F) – 20 W/350 °C (662 °F)
Heat up rating	65 W
Heat up time	Ca. 50 s auf 280 °C
Temperature range	150 – 450 °C
Temperature sensor	PTC
Cable	1,2 m ultra-flexible, heat-resistant, antistatic
Weight (without cable)	Approx. 30 g
Design	Antistatic

Vacuum pipette VAC PEN	
Designation	Value
Tube	1,0 m silicone
Weight (without tube)	24 g
Design	Antistatic

3. Concerning your safety

Ersa products are developed, manufactured and tested in compliance with general requirements concerning health and safety.

However, residual risk do remain!

You should therefore read this instruction manual before you start to operate the device for the first time. It will help you to learn the functions of the device and to use it in the most optimal way. Keep this instruction manual in a place that can be accessed by all users at any time!

3.1 Safety instructions



WARNING! Dangerous electrical voltage!

Death or very serious injuries due to electric shock!

In the event of faults in the electrical power supply, switch off the soldering station immediately!

Work on electrical parts may only be carried out by a qualified electrician or by persons instructed in electrical engineering under the direction and supervision of a qualified electrician in accordance with the electrotechnical regulations!

Never open the device!

Only use original fuses with the prescribed current rating!

Only use voltage-insulated tools!

Protect the connecting cable: Do not use the connecting cable to pull the mains plug or to carry the device! Keep connecting cables clear of heat, oil or sharp edges. Replace a damaged connecting cable



WARNING! Danger of electric shock when soldering!

Carry out soldering work only on de-energised parts!

Do not expose the soldering station and soldering iron to large mechanical loads!

Do not immerse the soldering tool in liquids to cool it off!



WARNING! Danger of fire and electric shock!

Humidity and moisture conduct electricity. This may lead to fires and electric shock.

Protect the device from moisture and humidity!

Do not switch on wet or humid soldering tools!



WARNING! Fire hazard due to hot soldering tool!

Before switching on the soldering station, all easily combustible objects, liquids and gases must be removed from the working area!

Always place the soldering tool in the supporting stand when not in use!

Disconnect the soldering station from the mains after use!



WARNING! Fire hazard due to unattended soldering station!

Keep any unauthorised people at a safe distance from the soldering station to prevent accidents and burns!

Never leave the soldering station unattended when running!

The soldering tool must be stored in its stand.

The temperature or switch-off times for the i-CON TRACE soldering station controlled with the "Ersa TRACE Cockpit" web app or "Ersa Trace" app may be set by the user of the i-CON TRACE soldering station only!

After switching off the soldering station, the soldering tool requires time to

cool down.



WARNING! Possible danger of fire or property damage!

Danger of heat accumulation if ventilation slots are covered!
Never cover the ventilation slots of the soldering station!



ATTENTION! Risk of burning by hot air!

The hot air jet should never come in contact with skin, hair or any heat-sensitive and combustible materials. Take care that you do not direct the hot air jet towards persons or yourself. Do not reach with your hands into the hot air jet. Use a sufficiently heat resistant work base and remove all combustible materials from your work environment.



DANGER! Danger due to improper operation

Comply with the operating instructions!

Every person involved in the commissioning, operation and/or maintenance of the soldering tool must have read and understood the “Safety Notes” and chapter “For your safety”, as well as the chapters in these operating instructions relating to the above tasks!

For the operation of the soldering tool, the local safety and accident prevention regulations must also be adhered to!

Always keep these instructions near the soldering tool, in a place accessible to all users at all times!



DANGER! Toxic fumes when soldering!

During soldering, emissions are produced from the solder materials and the assemblies. These emissions are harmful to health. Do not inhale the fumes!

Ensure sufficient ventilation or use a solder fume extraction system!

Adhere to the safety data sheets for the solder and flux materials used!



DANGER! Avoid any risk of injury!

Check the work tool for damage before switching it on!

Operate and store the work tool only under the ambient conditions specified in the data sheet!

Service and clean the work tool as provided for in the operating instructions!

Keep the workplace tidy!



DANGER! Risk of accidents! Do not damage the components of the soldering tools!

Check all components before each use!

Do not operate the soldering station if it is damaged!

Repairs may only be carried out by a specialist or the manufacturer!

Use only original Ersa consumables and spare parts.

Do not perform any retrofitting! Otherwise, the warranty will become null and void.

Never operate the soldering iron without the soldering tip, overheating hazard!



DANGER! Wear protective equipment!

During soldering, hot solder or corrosive flux material can splatter from the solder joint.

Avoid getting solder or flux material in the eyes or on the skin by wearing protective equipment!

Adhere to the company’s internal regulations for protective clothing!

Adhere to the safety data sheets for the solder and flux material used!

**CAUTION! Eating and drinking forbidden!**

Solders and solder materials are toxic. To prevent them from entering the organism, observe the following:

Do not eat, drink or smoke in rooms where soldering is taking place!

Always wash your hands thoroughly after working with solder and flux materials!

Adhere to the safety data sheets for the solder and flux materials used!

**CAUTION! Safe disposal of solder waste!**

Solder waste is hazardous waste and must not be disposed with the normal household waste. Provide safe and environmentally friendly disposal of operating materials, auxiliaries and replacement parts. Observe the municipal waste disposal regulations.

**ESD-sensitive components!**

Electronic components can be damaged by electrostatic discharge. Note the warnings on the packing or ask the manufacturer or supplier. To protect these components use an ESD-safe workplace (ESD = electrostatic discharge).

3.2 Intended use

Thermal tools from Erska must only be used for the processing of soft solder. However, if explicitly described in the operating instructions of the respective thermal tool, some thermal tools may, in exceptional cases, be used for the processing of plastic materials. In case of unintended use and tampering with the device, any warranty and liability claims of the buyer against the manufacturer will become null and void. Intended use also includes observing the operating instructions including the safety instructions.

3.3 National and international regulations

National and international health and safety regulations as well as occupational health and accident prevention regulations must be complied with.

4. Transport, storage, waste disposal

4.1 Transport and storage

The i-CON VARIO 2 is delivered in a strong cardboard box. Please use only the original packaging for transportation and intermediate storage. Strictly avoid jerky movements, impacts or putting down of the i-CON VARIO 2. The i-CON VARIO 2 must be adequately protected against weather influences like rain, fog or sea air, etc. For longer storage in high humidity environments the i-CON VARIO 2 must be packed up air tight, together with a dehumidifying agent. Damage caused by unprofessional transport or storage are not covered under warranty.

4.2 Waste disposal



Notes on waste disposal acc. to the directive 2012/19/EC of the European Parliament and the Committee from 4th July 2012 for used electric and electronic appliances:

Products marked with a crossed out waste bin must not be disposed of together with unsorted domestic waste. The municipalities established special collecting points for this type of waste.

Please consult your council and ask for available possibilities for the separated collection of old appliances.

You thereby contribute to the reuse or other forms of use of old appliances, with the aim of protecting the environment and human health.

5. Commissioning

5.1 Before start-up

Please check the contents in the package for completeness. Should any of the listed components be damaged or incomplete, you should immediately consult your supplier.

Contents		Order number						
		0ICV2005A	0ICV2005AI	0ICV2005AC	0ICV2005AXV	0ICV2005HP	0ICV2005XV	0ICV2005XVI
i-CON VARIO 2	0ICV2035A	1 x	1 x	1 x				
i-CON VARIO 2P	0ICV2035AP				1 x			
i-CON VARIO 2HP	0ICV2035HP					1 x		
i-CON VARIO 2X	0ICV2035X						1 x	1 x
i-TOOL AIR S	0470BRJ	1 x	1 x	1 x	1 x			
i-TOOL	0105CDJ		1 x					1 x
CHIP TOOL VARIO	0460MDJ			1 x				
X-TOOL VARIO	0740EDJ				1 x		1 x	1 x
i-TOOL HP	0240CDJ					1x		

All soldering irons are supplied with a matching supporting stand

In this context read chapter 9 [Spare parts, accessories].

5.2 Description

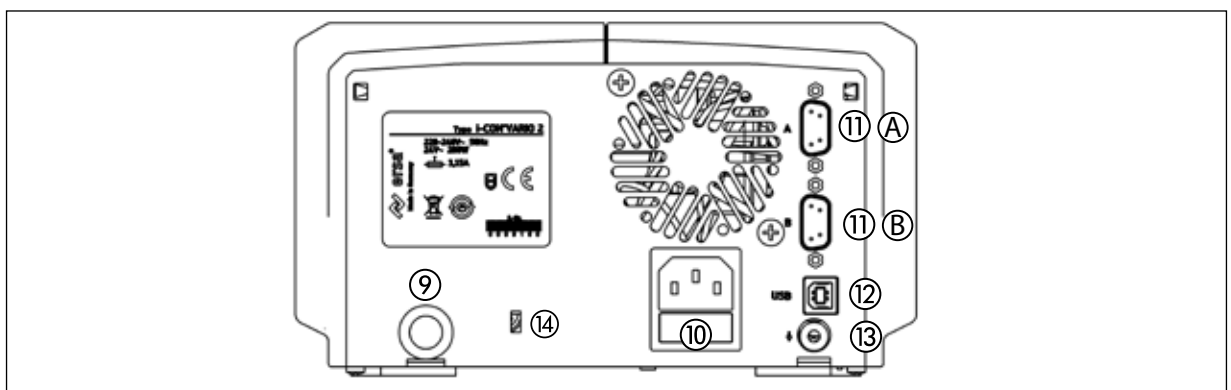
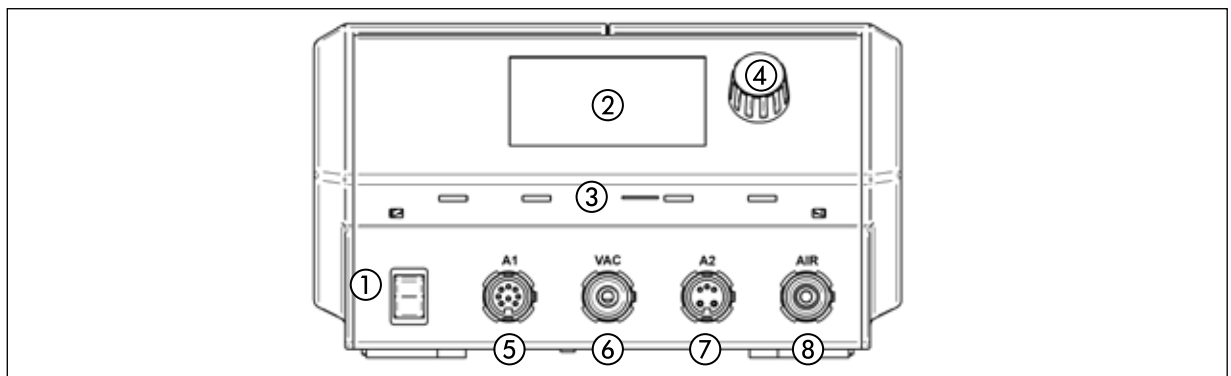

- ① Power switch
- ② Display
- ③ microSD slot
- ④ i-OP
- ⑤ Tool socket "A1"
- ⑥ Tool socket "VAC" (variant-dependent)
- ⑦ Tool socket "A2" (variant-dependent)
- ⑧ Tool socket "Air" (variant-dependent)
- ⑨ Air inlet
- ⑩ Mains socket with fuse
- ⑪ Interface connection A (Fume extraction or heating plate)
Interface connection B (Fume extraction)
- ⑫ USB-port
- ⑬ Socket for equipotential bonding
- ⑭ Connection for Kensington lock

5.3 Switching on the first time

For safe and durable operation of the soldering tools you must strictly observe the following items:

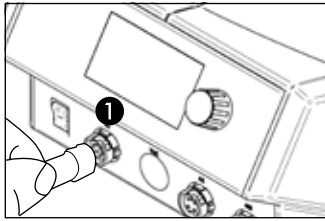

- Before switching on, make sure that the mains voltage complies with the value specified on the type plate.
- Switch off the soldering station by the mains switch.
- Check the correct fit of the soldering tip.
- Connect the soldering tool with the station ① (example illustration) and store it in the holder.

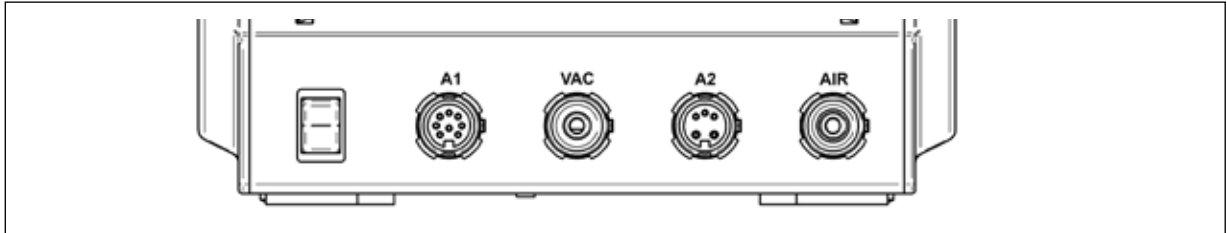

- Tool socket A1: electrical power supply, 150 W maximum
- Tool socket VAC: Vacuum supply (only with models with desoldering iron or with vacuum pump)
- Tool socket A2: electrical power supply, 200 W maximum (the socket assignment depends on the variant)
- Tool socket Air: Air supply



The table below contains information of which tools can be operated on which tool sockets. Tools requiring vacuum supply must be connected parallel to the tool sockets A1 and Vac (with i-CON VARIO 2X also A2 and VAC). Tools requiring air supply must be connected parallel to the tool sockets A2 and Air.

Soldering tool / station	i-CON VARIO 2	i-CON VARIO 2P	i-CON VARIO 2HP	i-CON VARIO 2X
i-TOOL	A1	A1	A1	A1 / A2
i-TOOL AIR S	A2 / AIR	A2 / AIR	-	-
X-TOOL VARIO*	-	A1 / VAC	-	A1 & VAC / A2 & VAC
CHIP TOOL	A1	A1	A1	A1
CHIP TOOL VARIO	A1	A1	A1	A1 / A2
i-TOOL HP	A2	A2	A2	-
TECH TOOL	A1	A1	A1	A1
MICRO TOOL	A1	A1	A1	A1
i-SET TOOL	A1	A1	A1	A1
VAC PEN*	-	VAC	-	VAC
<i>All tools that are not mentioned above are not recommended for the usage with this station.</i>				
<i>* With vacuum pump version only</i>				

From the interface connection ① (see p. 13, no. ①) a hot plate or a fume extraction can be controlled. With the Y-adaptor 0IRHP100A-15 both devices can be controlled from the interface port ①. From the interface port ② only a fume extraction can be controlled.

**CAUTION! Risk of burns!**

The soldering iron gets hot immediately after it is switched on!
Never touch the hot soldering tip or the hot heating element directly!

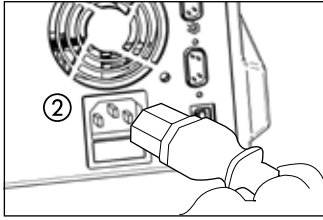

- Connect the mains supply cable with Rework heating plate and mains supply socket ②.

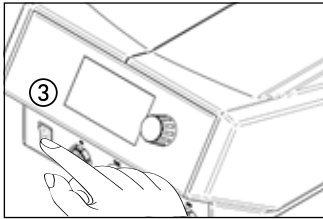

- Switch on the soldering station ③.

6. Functional description

6.1 Operation

The soldering station is switched on/off by the switch on the front ①.

The soldering station is controlled via a rotary encoder ② with push-button function (press). It is called i-OP. The i-OP allows the selection of desired functions or the change of values. Clockwise turning results in higher values and counter-clockwise turning in lower values. Slow turning effects change in increments of one. Quick turning changes the selected values in increments of 10/50/100 (depending on the corresponding parameter).

The i-OP has an additional push-button function. Via this push-button function (pushing), the selected parameters and values are confirmed and become effective for the station. In addition, this push-button function enables you to activate the connected tools alternately. All setting steps and measured values are displayed in plain text in a clearly structured display window, which is simply referred to as "Display".

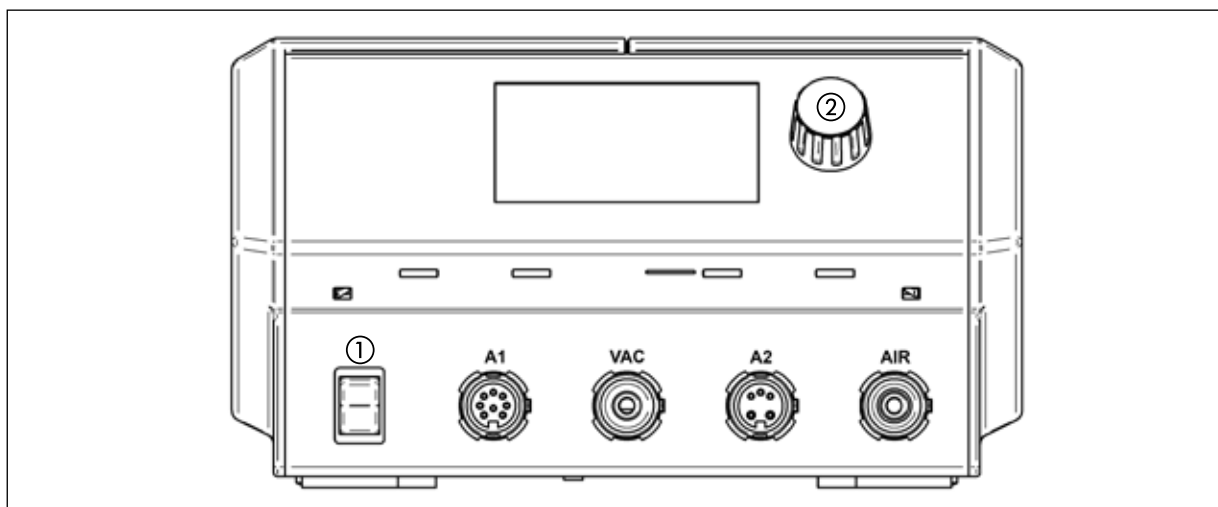

6.2 The work mode



After the station has been switched on, the switch-on dialog is displayed for approx. 2 seconds. It displays the name of the station ① and the software version ② of the i-CON VARIO 2.

After this the station automatically changes to working mode:



The names and values of the soldering tool currently pre-selected (active) for operation, are represented by means of bigger characters ③

The names and values of the soldering tool in the background (passive), are represented by means of smaller characters ④ with the parameters:



- Actual value of the active soldering tool ⑤.
- Actual value of the passive soldering tool ⑥.
- Nominal value of the active soldering tool ⑦.
- The actual value is inside the temperature window ⑧, see also chapter 6.4.1 [Temperature window].
- Password protection is active (KEY-symbol) ⑨.

6.2.1 microSD-card

The use of a microSD card allows to make firmware updates. For more information on using the microSD card, please refer to the firmware update instructions. The firmware and the update instructions can be found at www.kurtzera.com in section "i-CON VARIO 2" under "Downloads".

6.2.1.1 Insert microSD-card

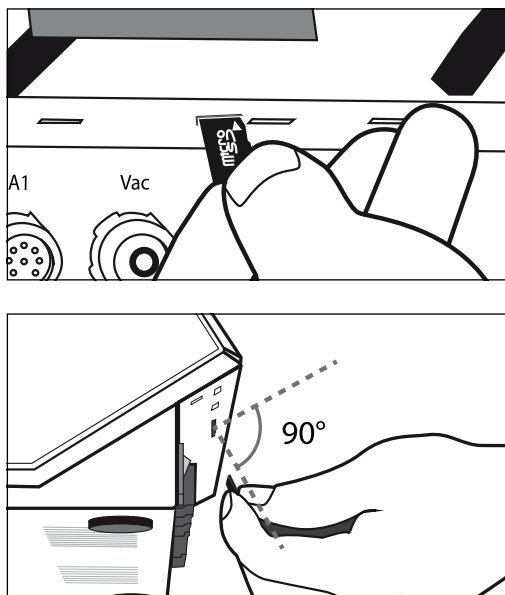

The station provides a port for a microSD-card.

- Insert the microSD-card into the port like shown on the right.
- You should recognize a slight resistance after inserting half the card. This is a sign that the card is inserted correctly.
- If there is no tangible resistance take the card out completely and try again.
- A firmware update is started automatically as soon as the card is inserted correctly. For carrying out any other application follow the menu navigation.
- The firmware and the update instructions can be found at www.kurtzera.com in section "i-CON VARIO 2" under "Downloads".

6.2.2 Software version

These operating instructions refer to the software version 1.3X. For service purposes the number of the software may be of help, you should therefore make a note of it and keep it ready, as you may need it when asked by our Service Department. The software version can be accessed via the menu [Contrast]. Please read the chapter 6.6 [Contrast] for more information!

6.2.3 Activating tools

If there are two tools connected to the soldering station, you can activate these alternately by pressing the i-OP.

A connected i-TOOL, X-TOOL VARIO, or CHIP TOOL VARIO is always automatically activated as soon as it is taken out of the holder.

In the working mode, the soldering tip temperature of the active soldering tool can be directly changed by turning the i-OP. This is confirmed by pressing the i-OP.



With the password protection activated, the nominal value can only be changed via the parameter mode. The password is needed for this.



For all soldering tools not specially mentioned in these instructions, you should consult the operating instructions for the corresponding tool.

6.2.4 Working with the i-TOOL AIR S



The i-CON VARIO 2 is equipped with an air supply, to be able to connect the hot-air soldering tool i-TOOL AIR S. In contrast to regular soldering tools, this tool transfers the required energy for soldering by means of hot air convection.



- Connect the i-TOOL AIR S to the sockets A2 and Air of the station. Switch the station on. If more than one tool is connected to the station, you just activate the i-TOOL AIR S by pressing the i-OP.
- You can now set the desired temperature by turning the i-OP ① and confirm this setting by pressing.

Adjusting the air flow:

- In order to adjust the air quantity turn the potentiometer ② on the handle of the i-TOOL AIR S. Turning clockwise increases the air quantity ③, while turning anti-clockwise reduces the air quantity.



The air quantity can be gradually adjusted from 2 to 20 l/min. The reading ③ in the display represents the air quantity.

Switching on and off:



- Take the soldering iron out of the holder and cover the optical sensor ④ twice. The flashing icon ⑥ at position ⑥ indicates the required pace. The i-TOOL AIR S is switched on and heats up to the adjusted temperature.



This switching on is confirmed by two short audible signals. Apart from this, the display ⑤ shows the increasing temperature.

- Switching the tool off works in the same way as switching it on.



This switching off is indicated by a long audible signal. Apart from this, the display changes between "OFF" ⑦ and the still existing iron temperature. The air flow of the iron is automatically switched off when the tool has cooled down to a temperature of 200 °C.

From VARIO firmware V.1.20 and i-TOOL AIR S V.1.04 you can adjust the sensitivity of the optical sensor in menu [Parameter], value [Opto Sensor].
 Default = [Med].
 [Low] = less sensitive, [High] = more sensitive.

Tips for operation and settings:

It is recommended to maintain a sufficient distance between the soldering good and the soldering tool while working with the i-TOOL AIR S. It is depending on the used air quantity and temperature and should be about 1 – 5 mm.

Operation	Temperature range in °C	Air quantity in l/min	Nozzle in mm
Thermal tests of electrical components	50 – 150	2 – 5	4, 6
Drying/Curing	100 – 200	5 – 20	6, without nozzle
Shrink tubing/Soldering sleeves	Material-dependent	5 – 10	all
Soldering of small SMDs	350 – 450	2 – 5	2, 4
Soldering of massive, multipolar SMDs	450 – 500	5 – 15	4, 6, without nozzle
Multipolar SMDs on light circuit boards	350 – 450	5 – 15	2, 4, 6
Multipolar SMDs on heavy circuit board ¹	450 – 550	10 – 20	4, 6, without nozzle
THT soldering	350 – 450	2 – 10	2, 4
¹ Additionally use a heating plate (0IRHP100A).			

6.2.5 Working with the CHIP TOOL VARIO

The desoldering forceps CHIP TOOL VARIO is equipped with two very small, but powerful heating elements. Each side has a heating power of 40 W, and differences in tip geometry enable reliable removal of even the smallest SMT-components.

The CHIP TOOL VARIO has two different mechanical operating modes. The user is able to choose between the normal operating mode and operation in clamping position.

- Connect the CHIP TOOL VARIO to tool socket A1 of the station.

Operation in clamping position:

In clamping position the components to be removed are held by the spring pre-load of the desoldering tool.



- Turn the button on top of the CHIP TOOL VARIO by 90 degrees to the horizontal position until it audibly engages to activate clamping position. The forceps is closed.
- To open the forceps press both blue handle elements at the right and left of the tool together.
- To close the forceps release both handle elements again.

Operation in gripping position:

In gripping position the components are gripped by manually closing the forceps arms.



- Turn the button on top of the CHIP TOOL VARIO by 90 degrees to the vertical position. The forceps is open.
- To close the forceps press both blue handle elements at the right and left of the tool together.
- To open the forceps release both handle elements again.

Adjusting the soldering tip

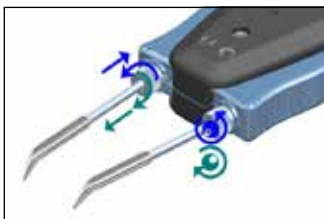

- Adjust the position of the soldering tip with the setscrews on the left and right side of the handle.
- Turning the left setscrew extends or shortens the left tip.
- Turning the right setscrew changes the position of the tips to each other.

Anti-twist protection:



- After the fine adjustment of the soldering tip, carefully tighten the hexagon socket screw of the tip with an Allen wrench (1.5 mm).
- Cautiously check if the tips can still be twisted and tighten the screw a little more if necessary.



Before changing the soldering tips the anti-twist protection must be loosened.

6.2.6 Working with the X-TOOL VARIO*

The X-TOOL VARIO is a more sophisticated high-performance desoldering iron with improved hand-piece.



6.2.6.1 Before first commissioning



- Assemble the holder of the desoldering iron, as shown opposite. Switch off the control station.



- Plug the pre-filter ① in the vacuum socket of the control station.
- Screw the Luer taper adapter ② on the pre-filter.
- Plug the vacuum hose on the adapter.
- Connect the circular connector of the soldering iron with a suitable tool socket.
- Switch on the control station and set the desired operating temperature for the X-TOOL VARIO.



CAUTION! Material damage is possible!

Always make sure that the filter plug, pre-filter and sintered filter disc are properly installed before using the tool.

6.2.6.2 Selection of the right desoldering temperature



CAUTION! Material damage due to high temperatures is possible!

Always select the lowest possible desoldering temperature for the task to be performed. Please keep in mind that higher temperatures also mean higher wear of the desoldering tip. Excessively high temperatures can also damage the board and components.

Standard values for set temperatures:

	Leaded solder set temperature	Unleaded solder set temperature
Not plated-through PCBs and smaller components such as resistors, capacitors and ICs	Approx. 270°C	Approx. 300°C – 320°C
Single-layer, plated-through PCBs	Approx. 270°C – 300°C	Approx. 300°C – 320°C
Multi-layer, plated-through PCBs	Approx. 300°C – 330°C	Approx. 330°C – 360°C
Multilayer and high-mass components	Approx. 350°C – 380°C	Approx. 400°C – 430°C

* Function only with models with vacuum pump



Ersa desoldering tips are modelled on the meniscus of the solder joint so as to ensure optimal heat transfer. Select the internal diameter of the desoldering tip in such a way that a small annular clearance of about 0.1 to 0.2 mm is left between the connection to be desoldered and the exhaust duct, so as to be able to suction the solder residues.

6.2.6.3 Desoldering with X-TOOL VARIO

- Run the tip of the desoldering iron over the component pin to be desoldered.
- Wait a short while until the solder that connects the component connector with the terminal pad is completely melted.
- Now, activate the vacuum by pressing the corresponding button. The solder is immediately conveyed through the soldering tip into the residual solder pot.

6.2.6.4 Maintenance and servicing X-TOOL VARIO



CAUTION! Material damage is possible!

Only use Ersa original spare parts and consumables to ensure safe operation and warranty coverage.

Important care work

- Make sure that the desoldering tip is always tin-plated.
- Wipe the desoldering tip, if necessary, before desoldering to remove flux material and solder residues with the dry cleaner or a damp sponge.
- Tin-plate the tip again before desoldering; this improves heat transfer and reduces desoldering time.
- Now and then clean the soldering duct using the included tip cleaner. This tool can loosen and remove flux material and solder residues.
- Change the filter in good time.
- Now and then use a new silicone holder, making sure it is made of high quality silicone. Due to temperature load, materials age and sealability is reduced.
- Make sure that ventilation openings do not become ineffective due to dust deposits.

Replacing pre-filters

If a pre-filter is dirty, it must be replaced. To do so, please follow these steps:

- Remove the X-TOOL VARIO from the pre-filter.
- Remove the pre-filter from the vacuum connection of the control station.
- Insert a new pre-filter.
- Re-install the X-VARIO TOOL hose on the pre-filter.

Clean the residual solder pot



CAUTION! Risk of burning!

The residual solder pot can heat up during desoldering. Let the tool cool down to room temperature before removing the residual solder pot. Place a warm residual solder pot only on heat resistant surfaces.

Removing/installing residual solder pots



- Let the tool cool down to room temperature.
- With a rotational movement, pull the residual solder pot out of the holder.
- To re-install the residual solder pot, press it back into the holder with a rotary motion until the edge of the container is level with the marking on the handle.

Replacing filter plugs



The sintered filter disc should be cleaned respectively replaced at each filter plug change.

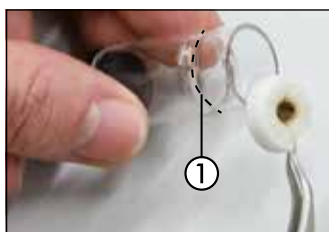

- Remove the residual solder pot, as described in previous chapter.
- Remove the filter plug from the residual solder pot.
- Remove the lid of the residual solder pot with a rotary motion.
- Clean the residual solder pot e.g. with the Erska cleaning brush, order no. 3N090.
- Insert a new filter plug. It must be pushed backwards up to the narrowing of the residual solder pot ①.
- Close the residual solder pot again.

Cleaning respectively replacing sintered filter discs



- Remove the heating head, as described in chapter 6.8.5 [Replacing the X-TOOL VARIO heating head].
- With tweezers, carefully remove the sintered filter disc from the silicone holder.
- Clean the sintered filter disc in an alcohol bath. Consider using an ultrasonic bath to remove stubborn dirt.
- Insert a new sintered filter disc into the silicone holder.
- Re-assemble the heating head, as described in chapter 6.8.5 [Replacing the X-TOOL VARIO heating head].
- Re-install the residual solder pot.



CAUTION! Material damage is possible!

Always make sure that the pre-filter, filter plug and sintered filter disc are properly installed before using the tool.

6.2.7 Working with the VAC PEN*

The vacuum placer VAC PEN enables precise handling of SMT-components. In order to be able to connect the VAC PEN to the station the prefilter must be installed on the VAC tool socket.



- In the configuration mode activate the [VAC PEN Mode] (see also chapter 6.4 [Configuration mode]). The display shows "VAC" ①.
- Connect the VAC PEN to the station. For this purpose use the VAC tool socket of the station.



With the VAC PEN Mode activated, you can switch between the first and the second tool and the VAC-option by simply pressing the i-OP.



- Press i-OP to select "VAC". The "VAC" indication flashes. By turning the i-OP you can change from standby to active mode ②. The VAC PEN is now ready for use.



- To pick up a component close the opening on the handle of the VAC PEN ③ with your finger. To release and place down the component remove your finger from the opening of the VAC PEN ③.



If the tool is not used for longer than 10 minutes, the VAC PEN will automatically stop working.

6.2.8 Setting heating stage of heating plate

With the soldering station you can control a infrared heating plate type 0IRHP100A. Setting the heating stage and switching the heating plate on and off is accomplished with the i-OP. Read more on this in the Section 6.4 [Configuration mode].



- In the working mode double-click the i-OP. The opposite display appears.
- To adjust the heating stage click the i-OP once more. Set the desired heating stage between [0] and [6] by turning the i-OP.



The heating plate can be operated with 6 heating stages. Stage [0]: The heating plate is switched off; Stage [1]: Lowest heating power; Stage [6] maximum heating power. The factory setting is [0].

- When the desired heating stage appears, press the i-OP to select the heating stage.

* With vacuum pump versions only

6.2.9 Working with the heating plate

The heating plate is switched on as follows:



- With the function [Heating plate] activated, you can switch on the heating plate in the working mode by double-clicking the i-OP.
- The window ① appears for 2 seconds. The symbol ② signals that the heating plate is working. Display ③ indicates the set heating range.

The heating plate is switched off as follows:

- Double-click the i-OP to switch off the active heating plate.

In working mode the heating range is changed as follows:

- Double-click the i-OP to switch on the heating plate. The window ① appears.
- Press the i-OP again. Select the desired heating range by turning the i-OP.
- Press the i-OP again to accept the set value. The heating plate now operates with the set heating range.



Once the soldering station changes to idle state, the heating plate is also switched off. The fact of the soldering station being taken out of the idle state does not automatically switch on the heating plate. You have to manually switch it on by double-clicking the i-OP. Read more about this in chapter 6.4.9 [Adjustable shut-down function (idle state)].

6.2.9.1 Power values of the heating plate

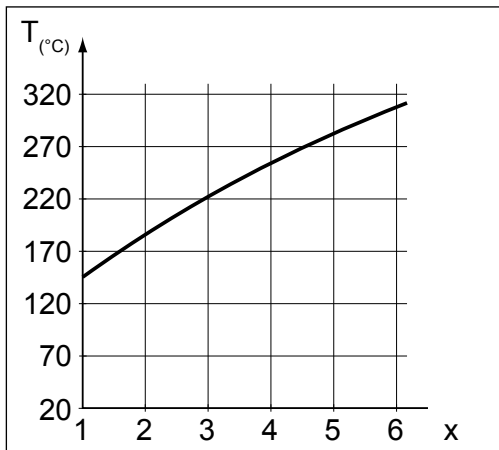

The maximum temperature has been limited to 300 °C (Heating stage 6) to prevent overheating of the heating plate.

The following characteristic shows the end temperatures of the heating plate at the various heating ranges.

- Horizontal (x): Set heating range
- Vertical (T): Temperature after 10 minutes of heating

6.3 Parameter mode

The following settings can be made in parameter mode:

- Nominal temperature (150 – 450 °C / 302 – 842 °F)
(i-TOOL AIR S 50 – 550°C/122 – 1020 °F)
- Calibration temperature (-70 ... +50 °C/-126 ... +90 °F)
- Peak offset (if required)
- Energy function (3 stages)
- Standby time (0 – 60 min)
- Standby temperature (150 – 300 °C), except i-TOOL AIR S.

Please proceed as follows to activate the parameter mode:

- Select the corresponding tool with the i-OP.
- Press the i-OP and keep pressed for 2 seconds.



The parameter mode is now activated for the chosen tool. The desired parameter is selected by turning on the i-OP.

The last line shows a help text ② regarding the selected parameter ①, which contains additional explanations or numerical ranges.



If no soldering tool is connected to the i-CON VARIO 2 when the station is switched on, you can, however, select a soldering tool in parameter mode and make your settings. The selected tool is thereby marked by an arrow.

Proceed as follows to change a parameter value:



- Press the i-OP to activate the soldering tool the parameters of which are to be changed.
- Press the i-OP and keep pressed for approx. 2 seconds to open the parameter mode for the active soldering tool.

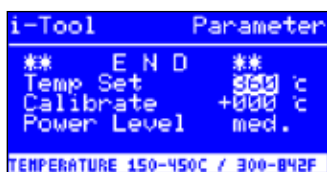

- Select the desired parameter by turning the i-OP.
- Press the i-OP to activate the cursor, pressing the i-OP again deactivates the cursor.

With the cursor is activated, turn the i-OP to change the value of the parameter accordingly.

6.3.1 i-SET TOOL

The i-SET TOOL (optional) enables you to save the settings (including the password) of the station in the i-SET TOOL and to write it back to the station. This way you can quickly transfer the basic settings to several stations. For more details please refer to the operating instructions for the i-SET TOOL. This is how you can use the i-SET TOOL:



- Disconnect the soldering tool from the tool socket and connect the i-SET TOOL with this socket
- Turn the i-OP and select the following:
 Upload: The data from the station is written into the i-SET TOOL.
 Download: Data from the i-SET TOOL is written into the station. Then press the i-OP.



- A safety dialog appears:
- Select [Cancel] to quit the process or [>>>] to continue.
 - Press the i-OP, the settings will be saved. Wait until the text [Parameter saved] appears in the display. Then remove the i-SET TOOL.



Display contrast, calibration and offset are not transferred. The transfer of data solely takes place via the tool sockets A1 of the i-CON VARIO 2. When transferring data to the soldering station, the parameters for all soldering tools will be overwritten. Please remember this when operating different tools on your soldering station.

6.3.2 Target temperature



The target temperature is the enabled soldering tool's temperature pre-set for working.



The tool's temperature can be changed directly in operating mode by turning i OP. Then press i-OP to confirm it.

6.3.3 Min. temp. / Max. temp.



The Min. temp. and Max. temp. parameters determine the temperature range in which the tool's temperature can be adjusted.



The tool's temperature can be changed directly in operating mode by turning i OP. This temperature can be reduced by adjusting the Min. temp. / Max. temp. parameters.

6.3.4 Calibration temperature



This function serves the purpose of calibrating the soldering tip temperature. It enables the balancing of display value and actual tip temperature. The adjustable calibration range is -70 ... +50 °C / -126 ... +90 °F.

The exact calibration procedure is described in the chapter 6.3.7 [Calibrating the i-CON VARIO 2].



If you do not have appropriate measuring equipment for this measurement, please enter "0" into this parameter field.

6.3.5 Setting the size of the hot air nozzle i-TOOL AIR S



The air quantity and temperature of the i-TOOL AIR S can be adapted to the hot air nozzle and the soldering process used. Once the i-TOOL AIR S is connected to the station, the option [Air nozzle] will appear. After pressing the i-OP one can adjust the type of the hot air nozzle used. Pressing again confirms the selection.

6.3.6 Tip offset

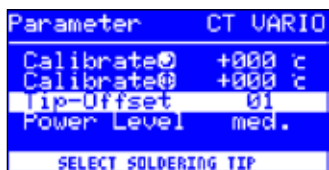

Due to the different masses and geometric shapes of the soldering tips, their thermal characteristics are quite different.

The tip offset serves the purpose of adapting the temperature measurement to the corresponding soldering tip used. The setting for the soldering tip used is made by entering a number.

Since the station automatically recognizes the connected soldering tool, the station is aware of the complete combination of tool and tip after selecting this number. This way temperature detection and control can work optimally. The tip offset can be adjusted from 1 up to the maximum possible limiting value (see table on next page) of the connected soldering tool.



With CHIP TOOL connected the entry [Tip type] will be displayed instead of [Tip offset]. In this case you can select the tip type directly.

CHIP TOOL	CHIP TOOL VARIO	i-TOOL AIR S	TECH TOOL		MICRO TOOL		X-TOOL VARIO	
Tip	Tip	Nozzle	Tip	No..	Tip	No.	Tip	No.
0452EDLF060	0462MDLF007	0472AR	612 SD	1	212 BD	1	0742ED0616H	1
0452MDLF020	0462MDLF015	0472BR	612 UD	1	212 CD	1	0742ED0819H	2
0452FDLF040	0462SDLF002	0472CR	612 BD	1	212 ED	1	0742ED1023H	3
0452FDLF075	0462PDLF005		612 AD	1	212 KD	1	0742ED1225H	4
0452FDLF100	0462CDLF010		612 KD	1	212 MS	1	0742ED1529H	5
0452FDLF125	0462CDLF018		612 ED	1	212 SD	1	0742ED2032H	6
0452FDLF150			612 GD	1	212 AD	1	0742ED2438H	7
0452FDLF175			612 CD	1	212 FD	1	0742ED1548H	7
0452FDLF200			612 TW	1	212 GD	1	0742ED2351H	7
0452FDLF250			612 MD	1	212 VD	1		
0452FDLF275			612 JD	1	212 RD	1		
0452FDLF400			612 ID	1	212 ID	1		
0452QDLF100			612 HD	1	212 ND	1		
0452QDLF125			612 ZD	1	212 WD	1		
0452QDLF150			612 ND	1	212 OD	1		
0452QDLF175								
0452QDLF200								
0452QDLF250								
0452RDLF150								
0452RDLF225								

6.3.7 Calibrating the i-CON VARIO 2

On the i-CON VARIO 2 two calibration functions are available, which are tool-dependent can be separately selected and adapted where necessary:

- Tip offset function and
- calibration function.



The Tip offset function is not available for a connected i-TOOL.

The following procedure is required to correctly calibrate the soldering station: First one must enter the tip used on the soldering tool (see section 6.3.6 [Tip offset]). Thereafter the station is able to automatically determine, regulate and display the correct tip temperature. If the tip offset is not specified correctly, the soldering tip may become unusable due to premature overheating.

By using the calibrating temperature (see section 6.3.4 [Calibration temperature]), the actual tip temperature is made tally with the temperature displayed. The following procedure must strictly be followed when calibrating:



- Adjusting the tip offset of the tip used (chapter [Tip offset], page 29).
- Input of the desired nominal temperature - (chapter [Nominal temperature]).
- Setting the calibrating temperature (chapter [Determining the calibrating temperature]).

6.3.8 Determining the calibration temperature



- Determine the temperature of the soldering tip by using a calibrated measuring instrument (e.g. Ersa DTM 100).
- Compare the display values of i-CON VARIO 2 and measuring instrument.
- Calculate the temperature difference:

$$\Delta T = T_{\text{i-CON VARIO 2}} - T_{\text{Measuring instrument}}$$
- Set the calculated temperature difference ΔT (with operational sign by turning the i-OP) in menu option [Calibr.-Temp].



Ensure calm air conditions to avoid measuring faults.

6.3.9 Energy

i-Tool	Parameter
Temp Set	360 °c
Calibrate	+000 °c
Power Level	med.
Standby-time	20sec
MEDIUM TEMPERATURE OVERSHOOT	

This function enables the user to influence the regulating behavior of the station, whereby the heating and after heating characteristic of the station can be adapted to the actual application. Three settings [high], [med.], and [low] are possible for i-TOOL, TECH TOOL, CHIP TOOL VARIO and i-TOOL AIR S. Due to their special control characteristics, all other tools work with constant control parameters.

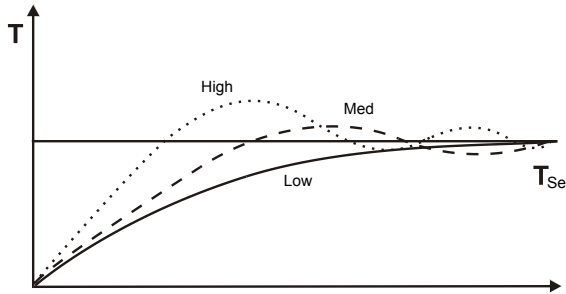

- [Low]: Minimal after-heating characteristic. For soldering work with low heat requirements.
- [Med.]: Stronger after-heating characteristic. For soldering work requiring more heat.
- [High]: Maximal after-heating characteristic. For soldering work with high heat requirements.

6.3.10 Standby period

i-Tool	Parameter
Calibrate	+000 °c
Power Level	med.
Standby-time	20sec
Standby-temp	250 °c
TIME FOR STANDBY FUNC.(0-60)	

The standby period is the time from the last work with the soldering tool to the point when the standby temperature is activated. For the i-TOOL and the CHIP TOOL VARIO the adjustment range is 20 seconds to 60 minutes. With all other tools the adjustment range is 1 ... 60 minutes. The input [0] deactivates the standby function (except i-TOOL AIR S).



With small joints or very smoothly performed soldering work the standby times should not be chosen too short, to make sure that the standby function will not lower the temperature already during the soldering process!

As a measure to save energy and to prolong the lifetime of soldering tip and heating element you can automatically trigger an idle state for the soldering tool. Read more about this in the chapter 6.4.9 [Adjustable shut-down function (idle state)].

6.3.11 Standby temperature

i-Tool	Parameter
Power Level	med.
Standby-time	20sec
Standby-temp	250 °c
** END **	
TEMPERATURE 150-300C/300-575F	

This is the soldering tip temperature during work breaks. It is automatically activated after the [Standby time] has expired. Lowering the temperature saves energy and prolongs the lifetime of tip and heating body.



With the i-TOOL and the CHIP TOOL VARIO reheating from standby temperature is caused by movement, with the Tech-Tool this is accomplished by short wiping with a moist sponge, with other tools by pressing or turning the i-OP (except i-TOOL AIR S).

6.4 Configuration mode

To enter the configuration mode press and hold the i-OP for 2 seconds when switching on the i-CON VARIO 2.

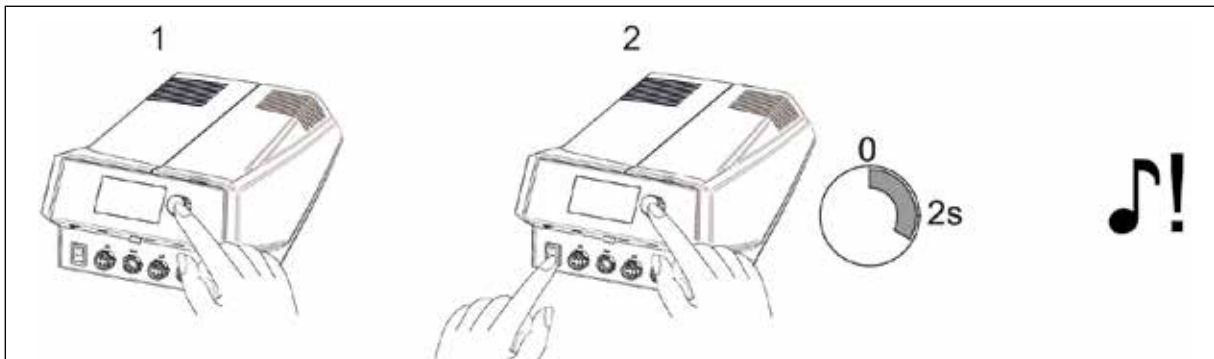

By turning and pressing the whole station can be configured or reset to factory settings.

In configuration mode the following settings can be adapted for the station:



- Temperature window (monitoring) left and right tool socket
- Process alarm (audible temp. control)
- Idle state (shut-down function)
- Password
- Temperature unit
- Activating the heating plate
- Language selection for the station
- VAC PEN Mode



With active password protection you cannot reset the soldering station to the “as delivered” state (default) without entering the password.

6.4.1 Temperature window

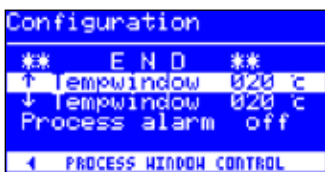

For each tool socket a temperature window with a separate upper and lower range can be defined.

When the actual temperature is within this window, “OK” is displayed in working mode.

Factory setting: ↑ 20 °C
 ↓ 20 °C (± 20 °C (68 °F)).



For the soldering tool connected to tool socket A1 the bottom line shows the symbol [◀]. For the soldering tool connected to tool socket A2 the bottom line shows the symbol [▶]. Keep turning the i-OP, until the temperature window indicates the desired socket.

6.4.2 Process alarm

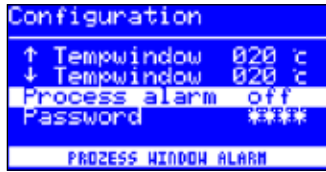

Once the actual temperature leaves the temperature window, a single audible signal will sound. Once the actual temperature returns to temperature window, a double audible signal will sound. Factory setting: [off].

6.4.3 Password protection

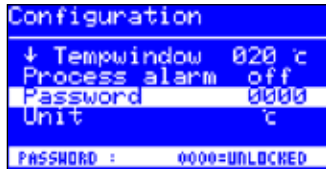

The data of the station can be protected by a 4-digit (0001-9999) password. This makes sure, that no settings/changes can be made. The password protection is not active by default, this is indicated by [0000] in the password input dialog.



The symbol ① signals that the station is protected. Factory setting: [0000] = no protection.



You should always remember the password you have chosen, or keep it in a safe place. A forgotten password can only be deactivated by Ersas. If you have an i-SET TOOL with saved factory settings, you can also unlock the station yourself.

6.4.4 Setting the password

Please proceed as follows to activate the function [Password]:



- Open the configuration mode and choose the option [Edit].
- Select the [Password] function by turning the i-OP.
- Press the i-OP to activate the cursor, pressing the i-OP again deactivates the cursor.



With the cursor activated, turn the i-OP to change the value of the parameter accordingly.

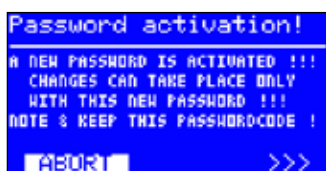

- Enter the desired password (numerical value between [0001] and [9999]) by turning the i-OP: Turn clockwise to increase, turn anti-clockwise to reduce.
- Press the i-OP to confirm the password, the first display will appear [Password activation]:

Either

- Choose the entry [ABORT] and confirm, in order to cancel the process. In this case there is no password protection.

Or

- Write down the set password, choose the entry [>>>] (Continue) and press the i-OP to confirm.

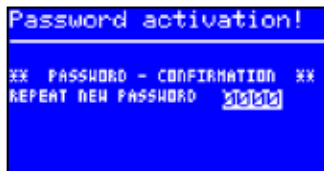

The second display [Password activation] appears:

- Enter the password once again and press i-OP to confirm your entry.

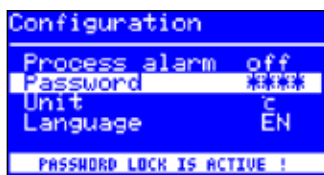

The display [Configuration] appears with the message [PASSWORD LOCK IS ACTIVE]. The station is now protected.

6.4.5 Changing the password

The password is set in configuration mode. If a password has already been set, the code appears "hidden".

If the user would like to change a password, the active password protection must first be revoked by entering the current password.

After a correct input, the new password can be set. If the numerical input is completed by means of the PUSH function, a note appears to inform you that the password protection will be activated. This note should once again inform the operator about the severity of this function. If the function is interrupted, the previous status will be maintained.

If the operator continues the dialog [>>>], the password needs to be repeated for activation.

If the password was repeated correctly, the station is protected by the code. If the code is entered incorrectly, you will receive a message stating that the previous condition will be maintained.



The symbol ① signals that the station is protected.

6.4.6 Password forgotten

If you have forgotten your password, this can only be reactivated by the Ersä Service for reasons of safety. In this case please consult Ersä by stating your address, name, invoice number and serial number of the soldering station (see type plate). The password protection can also be disabled with the i-SET TOOL; see chapter 6.3.1 [i-SET TOOL]. For this purpose follow the corresponding note in chapter 6.4.3 [Password protection].

6.4.7 Temperature unit



Here you can choose the desired temperature units Degree Celcius (°C) or Fahrenheit (°F). Factory setting: “°C”

6.4.8 Language selection

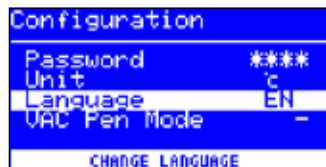

Here you can choose the desired language for the menus of the i-CON VARIO 2. Factory setting: “English”

6.4.9 Adjustable shut-down function (idle state)



The adjustable shut-down function (Idle state) serves the purpose of energy saving and prolonging the lifetime of soldering tip and heating element. In idle state the tools cool down to room temperature. The bottom line in the display then shows the text [Idle state]. You can end idle state at any time by actuating the i-OP.

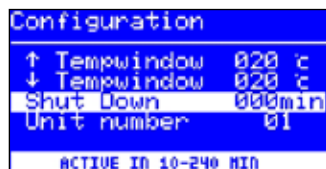

Please proceed as follows to activate the function [Idle state]:

- Open the configuration mode and choose the option [Idle state].
- Activate the menu [Idle state] by turning the i-OP.
- Press the i-OP to activate the cursor, pressing the i-OP again deactivates the cursor.
- Enter the desired time from [010] to [240] minutes by turning the i-OP accordingly. The input [000] deactivates the function [idle state].



With the cursor activated, turn the i-OP to change the value of the parameter accordingly. The set time applies for both connected tools. The set time starts to run, only after both tools are in [Standby]. If the tools are still not used during this time, idle state is activated after this time has expired.

With the i-TOOL and the CHIP TOOL VARIO idle state is automatically terminated when the tool is taken out of the holder. Once the first tool has “woken up” from idle state, the second tool will also be reactivated. The i-TOOL AIR S must be explicitly switched on. Find more about this in chapter 6.2.4 [Working with the i-TOOL AIR S].

A controlled heating plate is not automatically activated! Find out more about this in chapter 6.2 [The work mode].

6.4.10 Heating plate

You can use the soldering station to control the infrared heating plate 0IRHP100A.

The following accessories are needed:

- Control cable from soldering station to the infrared heating plate 0IRHP100A
- Y-control cable given that the soldering smoke extractor and the infrared heating plate 0IRHP100A are to be controlled together.



An infrared heating plate, a soldering fume extraction or both can be connected to the station. With the i-CON VARIO 2 you can operate up to two additional devices.

6.4.10.1 Connecting heating plate to soldering station

- Connect the control cable of the heating plate with the interface connection A of the soldering station.
- Switch on the heating plate.

6.4.10.2 Activating the heating plate



- In configuration mode select the menu [Heating plate] by turning the i-OP.
- Activate the cursor by pressing the i-OP.
- Activate the function by turning the i-OP. The opposite display appears.
- Quit the configuration menu.



Information on working with the heating plate can be found in the chapter 6.2 [The work mode].

6.4.11 Activating the soldering fume extraction

You can use a soldering fume extraction with the soldering station.

- Connect the solder fume extraction to the control cable and the latter to an interface connection (see page 13, no. ⑪).



A connected soldering fume extraction is activated automatically as soon as a tool is taken out of the holder or is switched on.

6.4.12 Activating VAC PEN Mode

Enable the VAC PEN mode, in order to use the VAC PEN.

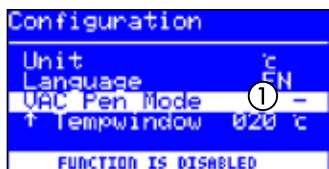

- In configuration mode select the menu [VAC PEN Mode] by turning the i-OP.
- Activate the cursor by pressing the i-OP.
- Select the desired function by turning the i-OP activate it by pressing the button. There are 3 different modes available. Depending on the selected mode one of the opposite displays will appear.

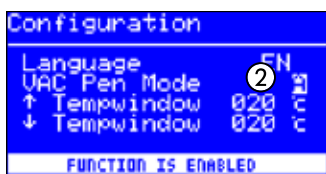

- ① The VAC PEN Mode is deactivated.
- ② The VAC PEN Mode is activated.
- Quit the configuration menu.



VAC PEN and X-TOOL VARIO can not be operated simultaneously.

6.5 Factory settings (“Default”)

The following list shows the settings with which the station has been programmed in the factory. These settings can be restored via the “Default function” in configuration mode. The only exception is the setting of the password, which is first queried via the default function and is overwritten afterwards.

Configuration mode	
Parameter	Setting
↑ Temperature window left hand side	20 °C
↓ Temperature window left hand side	20 °C
↑ Temperature window right hand side	20 °C
↓ Temperature window right hand side	20 °C
Idle state	000
Heating plate	0
Process alarm	Off
Password	0000
Unit	°C
Language	EN
VAC PEN Mode	–

Parameter mode								
Parameter	i-TOOL	i-TOOL AIR S	i-TOOL HP	TECH TOOL	CHIP TOOL	CHIP TOOL VARIO	MICRO TOOL	X-TOOL VARIO ¹
Nominal temp. °C	360	380	360	360	385	360	285	360
Calibr. temp. °C	0	0	0	0	0	0/0	0	0
Tip offset/type	–	472BR	1	1	422 MD	462MD007	1	04
Energy	Medium	Medium	Medium	Medium	-	Medium	-	Medium
Standby time (min)	2	1	5	10	10	5	10	5
Standby temp. (°C)	210	-	50	230	280	50	280	50

¹ With vacuum pump models only

6.6 Contrast



Please proceed as follows to adapt the display contrast to your working environment:

- Switch on the station and rotate the i-OP immediately. This activates the contrast mode:



The buzzer sounds to signalize that the contrast mode is active.

- Set the desired contrast by turning the i-OP.
- Confirm your input by pressing the i-OP.

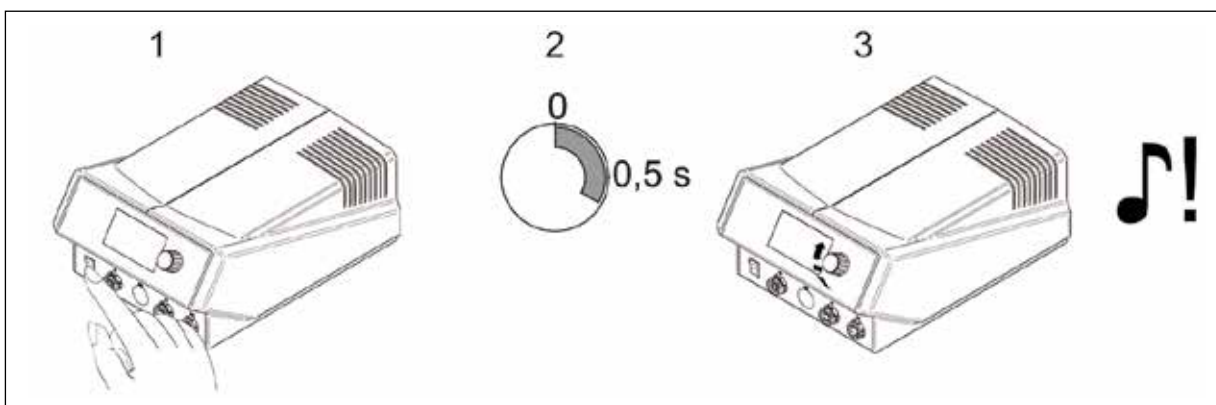

In the contrast mode the software version, the date and the hardware version of the controlboard (CB), the powerboards (PB) und and the tools connected to the tool sockets can be displayed. Activate the contrast mode as described above, click and hold the i-OP afterwards. Clicking and holding the i-OP for a second time closes the display.

6.7 Changing soldering tips

Soldering tips must be changed when:

- The size of the soldering tip does not match the soldering joint (current tip too big / too small).
- The soldering tip is worn or damaged (pitting corrosion, tip can no longer be wetted, mechanical damage).

Before replacing the soldering tip:

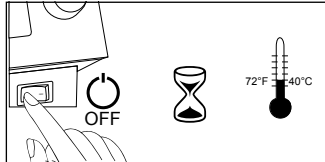

- Switch off the station. Allow the unit to cool to a safe temperature.
- The tool for changing the tip (if necessary) should be at hand.



ATTENTION! Risk of burning!

Only use appropriate tools to change soldering tips and hot air nozzles. Changing still hot soldering tips takes place at your own risk! If necessary allow the soldering tip to cool down completely before changing it.



CAUTION! Material damage is possible!

Do not operate the soldering tools without a soldering tip, otherwise the heating element could be damaged!

6.7.1 i-TOOL

Replace the soldering tip when it is worn.

- To prevent any material damage due to overheating, switch off the heating element or the soldering station before each soldering tip replacement!
- To prevent any material damage due to overheating, never operate the soldering iron without the soldering tip!



Attention! Burn hazard!

After switching off, the soldering tip remains hot for a long time!
Always touch only the knurled plastic part

When the tip has cooled off, proceed as follows:

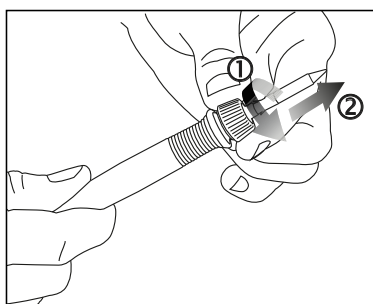

- Unlock ① and pull off ② the soldering tip.

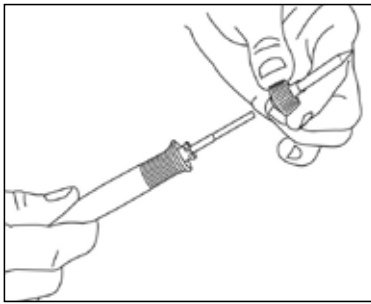

- Remove the soldering tip.

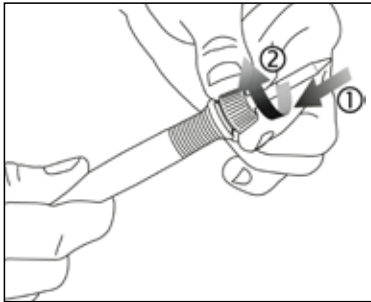

- Fit the soldering tip ①, overcome the spring force and lock the bayonet mount ②.

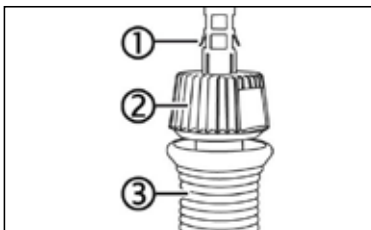

- To check the soldering tip for tight seating:
- Keep a correct distance between the knurled sleeve ② and the soldering iron ③, as shown in figure on the left.
- The bayonet mount of the knurled sleeve is completely locked.
- The display panels ① do not touch the knurled sleeve ②.

6.7.2 Changing the hot air nozzle i-TOOL AIR S

- Loosen the covering tube ① by turning the knurled nut anti-clockwise.
- Pull off the covering tube ①.
- Carefully pull off the hot air nozzle with the tip change forceps ②.

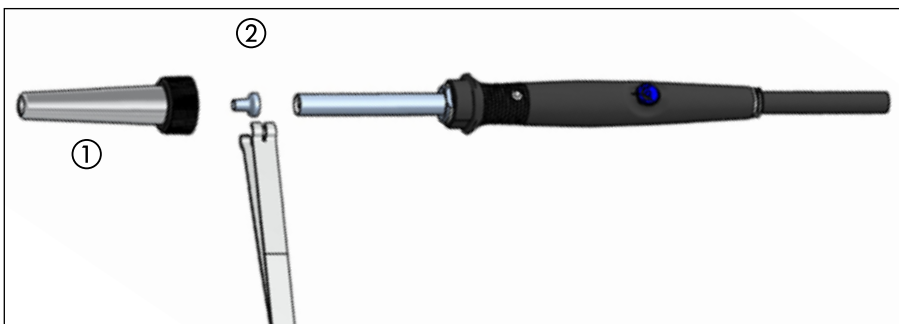

6.7.3 Changing desoldering tips of X-TOOL VARIO

A desoldering tip can be changed using the tip holder fitted to the supporting stand, with the included tip changing pliers (no. 3N597), or with the VARIO TOOL (no. E074600).

Tip change using a tip holder:



- Place the desoldering tip with its radially running groove in one of the slots of the tip holder.
- Secure the supporting stand with one hand.
- Pull off the desoldering iron from the top with the other.

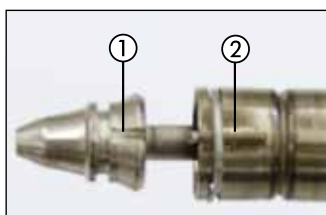

- To insert a new tip ①, introduce it into the slot of the tip holder and then insert it into the heat accumulator ②.
- The pin on the heat accumulator has to audibly snap into the tip recess.

Tip change using tip changing pliers (3N597):

- Using the tip changing pliers, grab the tip at the groove and pull it out of the heat accumulator.
- To insert a tip, grab it at the groove with the tip changing pliers and insert it into the heat accumulator.
- The pin on the heat accumulator must snap into the pin recess.



Caution! Material damage possible!

Do not twist the tip during extraction, otherwise the temperature sensor could be damaged!

6.7.4 Replacing the CHIP TOOL VARIO heating element

See chapter 6.8.3 [Changing the CHIP TOOL heating element].

6.7.5 Replacing the i-TOOL HP tip



- To loosen pull the black bayonet fitting to the handle and twist open to the left.
- Carefully press the soldering tip laterally out of the holding cage. Avoid jamming.
- Insert the new tip into the holder cage of tip mounting. Avoid jamming.
- The tip must engage in the holder cage.



6.8 Changing a heating element

Before changing a heating element:

- Switch off the station and allow the soldering tip to cool down. Then remove the soldering tip as described above.



ATTENTION! Risk of burning!

Allow the unit to cool to a safe temperature.

6.8.1 Changing the i-TOOL heating element



Attention! Burn hazard!

Only change the heating element when both the soldering tip and the heating element are cold!

Before changing the heating element, switch off the soldering station and allow the soldering tip and the heating element to cool down!

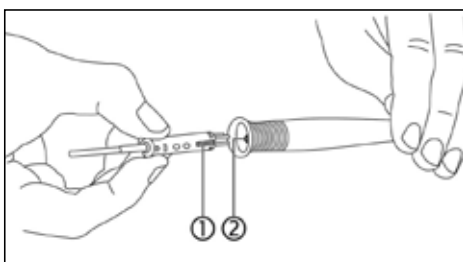

- Remove the soldering tip.
 - Pull the heating element out by hand.
- Slide in the spare heating element.
- Align the groove of the heating element a with the marking in the soldering iron b.
 - Align the heating element exactly parallel to the soldering iron.
 - Gently push the heating element in carefully and slowly until it stops. If the heating element cannot slide in easily, do not press with greater force, but reposition it!
 - Re-install the soldering tip

6.8.2 Changing the i-TOOL AIR S heating element

- Please return the tool to the Erska Service to have the heating element replaced.

6.8.3 Changing the CHIP TOOL heating element

- To change the heating element please proceed as described in the operating instructions of "Ersa CHIP TOOL" (3BA00128-00).

6.8.4 Changing the CHIP TOOL VARIO heating element

On the CHIP TOOL VARIO a desoldering tip always consists of a heating element and a soldering tip. A pair of desoldering tips should never be separated during use.



When aligning the tips with each other, the anti-turn locking device must be always disengaged.



- Disengage the ① anti-turn locking device with an Allen key no. 1.5.



Overtightening the retaining screws may damage the heating element.



- Pull the desoldering inserts carefully out of the holders of the CHIP TOOL VARIO ②.
- Carefully push a new pair of desoldering inserts up to the mark into the holders.



- In doing so, the mark on the ③ desoldering insert must be completely pushed into the holder.

6.8.5 Replacing the X-TOOL VARIO heating head



- Disconnect the tool from the control station and let it cool to room temperature.
- Remove the tip and the residual solder pot.
- Press the two latches ④ on both sides of the heating head cover and pull this off.



- Carefully pull out the heating head with the silicone holder.
- Remove the silicone holder.



- Place the silicone holder on the new heating head.
- Install the new heating head and close the heating head cover again.
- Re-insert the tip and the residual solder pot.
- Re-connect the tool to the control station.

6.8.6 Changing the i-TOOL HP heating element

Clean the heating element on a regular basis. Change the tip at least once daily (e.g. at the end of the shift). Cleaning with the accompanying brass brush will prevent the tip from sticking. Use the brush only to clean the heating element, so as to avoid transferring any tin from the soldering tips.



- Open the bayonet lock of the tip by twisting and pulling.



- Remove the tip retainer and the soldering tip.



- Carefully unplug the heating element.



- Insert the new heating element into the handle.

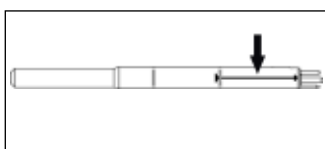

- Observe the long mark on the heating element.

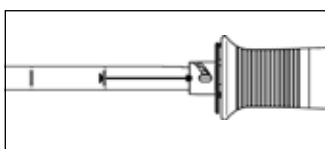

- Align the mark to the semicircular groove in the soldering iron.

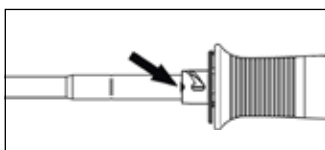

- Push in the heating element until the mark flushes with the groove.

6.9 Changing the prefilter

The prefilter is placed into the VAC socket of the soldering station in order to protect tools with a vacuum connection from contamination. Order-no. 3YE1057-02.



- Pull of the tube of a connected tool before changing the prefilter ①. Remove the used filter from the plug by pulling and turning at the same time.
- Push a new filter into the socket.
- Plug in the tube of the tool again.

6.10 Sensitive components

Some components may suffer damage when being exposed to electrostatic discharge (please follow the warnings on the packages or ask the manufacturer or supplier). An ESD-safe (ESD = Electrostatic Discharge) workplace provides sufficient protection for such components. The soldering station can be easily integrated into such an environment. The soldering tip can be highly resistively ($220\text{ k}\Omega$) connected with the conductive work base via the equipotential bonding socket (1).

The soldering station is fully antistatically equipped and thus meets the requirements of the American Military Standard.

Upon delivery the soldering tips are directly connected with the protective network conductor.

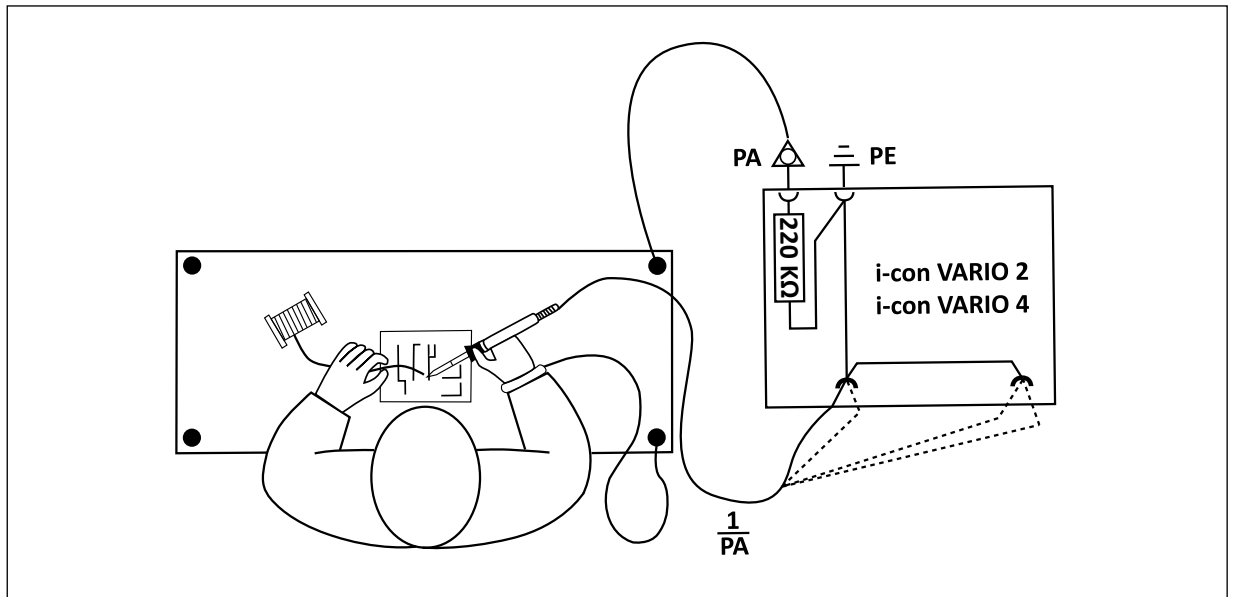

7. Error diagnosis

7.1 General errors

If the soldering station does not operate as expected, check the following items:

- Is the mains voltage present? Correctly connect the mains lead to the device and socket.
- Is the fuse defect? The fuse can be found at the rear side of the device in the mains connecting socket.
- Note that a defective fuse may also indicate a deeper cause of error. Simply changing the fuse therefore generally does not suffice.
- Is the soldering tool correctly connected to the supply unit?

7.2 Other faults

- This station permanently shows a too high actual temperature. This fault can occur when operating a CHIP TOOL. In this case switch off the station and replace the soldering tool with a flawless one.
- Should the soldering station be overloaded, it will automatically shut down and the display will be empty. Once the soldering station has cooled down to a sufficient level (approx. 30 minutes) work can be continued.

7.3 Parameter changes not possible

If the station is password protected, the parameters can only be changed after entering the correct password. (see chapter 6.4.3 [Password protection]).

7.4 Error Messages



Example image

The i-CON VARIO 2 carries out automatic error diagnostics. The result of a diagnosis is displayed as an error code: The triangular pictogram ① thereby appears in the display of the soldering station. The error code ② is displayed in form of a number. The bottom line shows an additional help text ③.

The position of the error message in the display shows the tool socket side of the tool. In the example image = tool in the left tool socket.

The error codes can be taken from the following table. Error messages must be acknowledged through the i-OP. The connected soldering tool will only be heated again, after the fault has been rectified and acknowledged.

Code	Test in display	Cause	Remedy
1	[MICRO SD CARD]	microSD card error. MicroSD card connector defective.	Remove and put in card again. Contact area must be on the backside. Format card using FAT32 and reload file. Use different microSD card.
2	[CALIBRATION FAULTY]	Station no longer calibrated	Have calibrated in the factory
4	[RT-COMPENSATION]	Measuring value of the KTY not OK	Have soldering tool and soldering station inspected
6	[UNDEF. TOOL!]	The soldering station is unable to identify the connected tool. Undefined new tool. Defective Tool.	Remove tool. Update firmware. Replace tool.
7*	[HE PLUGGED IN? THERMOCOUPLE?]	Heating element not correctly installed / Fault in temperature sensor	Install the heating element correctly, have the soldering tool inspected
7*	[THERMOCOUPLE?]	Fault in thermocouple	Have soldering tool and station inspected
8	[HEATING ELEMENT?!]	Heating element defective. CHIP TOOL VARIO: HE PLUGGED IN?	Check the heating element / check the station; Install the heating element correctly, have the soldering tool inspected
9	[LOSS OF DATA!]	Parameter/configuration data corrupted	Use configuration mode to reset the soldering station to factory settings
10	[iCON-SYSTEM ERROR]	Hardware fault of the controller board	Have the controller board exchanged
51	[VAC LEAKAGE!]	VAC underpressure leakage. VAC PEN: Tube bend.	Plug on the tube. Avoid the tube being bend!
52	[NO AIR!]	Blow-air pump defective. i-TOOL AIR S air tube not plugged on or bend.	Plug on the tube. Avoid the tube being bend! Switch soldering station off and on again. Get soldering station checked.
62	[CALIBRATION FAULTY]	Station no longer calibrated	Have calibrated in the factory
71	[iTOOL UND HE DEFECTIVE/REPLACE]	The electronics as well as the heating element of the i-TOOL are defective.	Replace the i-TOOL.
97	[DATA TRANSFER ERROR]	–	–
98	[MAINS FREQUENCY?]	Mains frequency outside the frequency range (±10%)	–
99	[i-CON OVERLOAD PROTECTION]	Soldering station overloaded	Allow the soldering station to cool down

* If error code 7 only occurs when i-TOOL and CHIP TOOL VARIO are operated simultaneously, insert only one tool alternately to eliminate the error. Always confirm error messages. If error code 7 occurs again only with simultaneous operation, an error in the radiator of the i-TOOL leads to an error message of the CHIP TOOL VARIO. See also chapter „6.8.1 Changing the i-TOOL heating element“ auf Seite 42].

If the soldering station is sent in for repair, all associated tools must also be sent in.

8. Maintenance and cleaning

8.1 Important service work

The following points must be complied with to achieve a long lifetime of the station.

- Always make sure that the soldering and desoldering tips are tin coated. A continuously cleaned soldering tip will become passive after a short while. If you always leave a small amount of solder on the soldering tip after soldering, you will prolong the lifetime many times over.
- If necessary wipe the soldering and desoldering tip against a moist sponge or pierce it into the dry cleaner before the soldering or desoldering process, in order to remove old solder and flux material residues.
- The soldering nozzles of the i-TOOL AIR S can be cleaned if necessary by using a small brass brush.
- In order to achieve good electric and heat conductivity you should remove the soldering tip from time to time and clean the heating element with a brass brush.
- Take care that the ventilation openings on the station will not lose their effect because of dust deposits. Check also the condition of the air filter on the back of the station. If this filter is dirty or the air power is reduced, replace this filter (see chapter 8.3 [Replacing the air filter]).



Only used original consumables and spare parts from Ersas, to keep up the safe and reliable function and warranty!



There are no serviceable parts inside the device!

8.2 Cleaning

Occasionally clean the device with a damp, soft cloth. Steam or high pressure cleaners, scrubbing sponges, abrasive cleaners, solvents like alcohol or gasoline must not be used!

8.3 Replacing the air filter

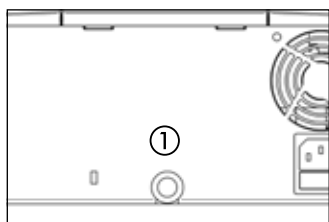

- Pull the contaminated air filter (order no. 3ZT00270) with pincers carefully out of the opening ①.
- Grip the new air filter carefully with the pincers and push it into the opening. The filter should be pushed in for about 3 mm and touch all sides of the air inlet opening.







9. Spare parts, accessories

Spare parts, accessories		
	Designation	Order-No.
	Soldering iron i-TOOL, 24 V, 150 W, antistatic with tip 0142CDLF16	0105CDJ
	i-TOOL AIR S	0470ERJ
	CHIP TOOL VARIO	0460MDJ
	MICRO TOOL	0270BDJ
	VAC PEN with connecting hose	0VP020
	i-TOOL HP	0240CDJ
	Heating element for i-TOOL	016100J001
	Heating element for i-TOOL HP	024100J
	Holder for i-TOOL	0A59
	Holder for i-TOOL AIR S	0A58
	Holder for CHIP TOOL VARIO	0A54
	Heating element and tip change forceps for i-TOOL, i-TIPS, i-TOOL AIR S hot air nozzles	3N544
	Hot air nozzle i-TOOL AIR S, Ø 1.7 mm, bended	0472DR
	Hot air nozzle i-TOOL AIR S, Ø 2 mm	0472AR
	Hot air nozzle i-TOOL AIR S, Ø 3.5 mm, bended	0472ER
	Hot air nozzle i-TOOL AIR S, Ø 4 mm	0472BR
	Hot air nozzle i-TOOL AIR S, Ø 6 mm	0472CR

Spare parts, accessories		
	Designation	Order-No.
	i-SET TOOL	0103IST
	Heating element for i-TOOL	010102J
	Viscose sponge for holder	0003B
	Cleaning brush with brass bristles	3TZ00051
	Dry sponge with receptacle for 0A39 – 0A48	0A08MSET
	Dry sponge	0008M15B
	Prefilter with Luer adapter	3YE1057-02
	Front sealing plug	3T7260-02
	Back sealing plug	3T7260-03
	Residual solder container, complete	72600
	Control line i-CON VARIO 2 to the heating plate	0IRHP100A-14
	Y-control cable for simultaneous connection of heating plate and soldering fume extractor	0IRHP100A-15
	Filter part	3ZT00270
	Spare parts for CHIP TOOL, see operating instructions "Ersa CHIP TOOL" (3BA00128-00).	
	Spare parts for X-TOOL VARIO, see operating instructions "Ersa X-TOOL VARIO" (3BA00215)	

Other spare parts can be found in Ersas webshop: www.ersashop.com

9.1 Desoldering tips CHIP TOOL VARIO (one pair each)

Spare parts, accessories		
	Designation	Order-No.
	Chisel shaped, 0.7 mm, angled	0462MDLF007
	Chisel shaped, 1.5 mm, angled	0462MDLF015
	Pen pointed, 0.2 mm, angled	0462SDLF002
	Pen pointed 0.5 mm	0462PDLF005
	Chisel shaped 1.0 mm	0462CDLF010
	Chisel shaped 1.8 mm	0462CDLF018

For further information please refer to:

www.kurtzrsa.com/electronics-production-equipment/soldering-tools-accessories.html

10. Warranty

Heating elements and soldering or desoldering tips are treated as wearing parts, and are therefore not subject to the warranty. Any return of goods must be accompanied by a written description of the material or construction fault that has occurred as well as a confirmed purchase invoice.

Ersa created these operating instructions with greatest care and attention to detail. However, no warranty can be granted with respect to contents, completeness and quality of data in this manual. The contents is continuously updated and adapted to prevailing conditions.

All data published in this manual, including specifications concerning products and procedures, were determined by us to the best of our knowledge and ability, and using cutting edge technical aids. These specifications are non-binding and for information only; they do not relieve the user from his responsibility of carrying out his own check before operating the device. We do not assume liability for violations of patent rights of third parties for applications and procedures without previous express and written confirmation. We reserve the right for technical modifications with the intention of improving the product.

Within the scope of legal possibilities, liability for immediate damage, including direct and indirect damage, which results from the acquisition of this product, is ruled out. All rights are reserved. This manual, or any parts thereof, may not be reproduced, changed, transferred or translated into another languages without the written consent of Ersa GmbH.

*To the extend this product contains Atmel software, such software is copyrighted by Atmel: Copyright (c) 2009-2012 Atmel Corporation. All rights reserved.
THIS SOFTWARE IS PROVIDED BY ATMEL "AS IS" AND ANY EXPRESS OR IMPLIED WARRANTIES, INCLUDING, BUT NOT LIMITED TO, THE IMPLIED WARRANTIES OF MERCHANTABILITY, FITNESS FOR A PARTICULAR PURPOSE AND NON-INFRINGEMENT ARE EXPRESSLY AND SPECIFICALLY DISCLAIMED. IN NO EVENT SHALL ATMEL BE LIABLE FOR ANY DIRECT, INDIRECT, INCIDENTAL, SPECIAL, EXEMPLARY, OR CONSEQUENTIAL DAMAGES (INCLUDING, BUT NOT LIMITED TO, PROCUREMENT OF SUBSTITUTE GOODS OR SERVICES; LOSS OF USE, DATA, OR PROFITS; OR BUSINESS INTERRUPTION) HOWEVER CAUSED AND ON ANY THEORY OF LIABILITY, WHETHER IN CONTRACT, STRICT LIABILITY, OR TORT (INCLUDING NEGLIGENCE OR OTHERWISE) ARISING IN ANY WAY OUT OF THE USE OF THIS SOFTWARE, EVEN IF ADVISED OF THE POSSIBILITY OF SUCH DAMAGE.*

Electronics Production Equipment worldwide present

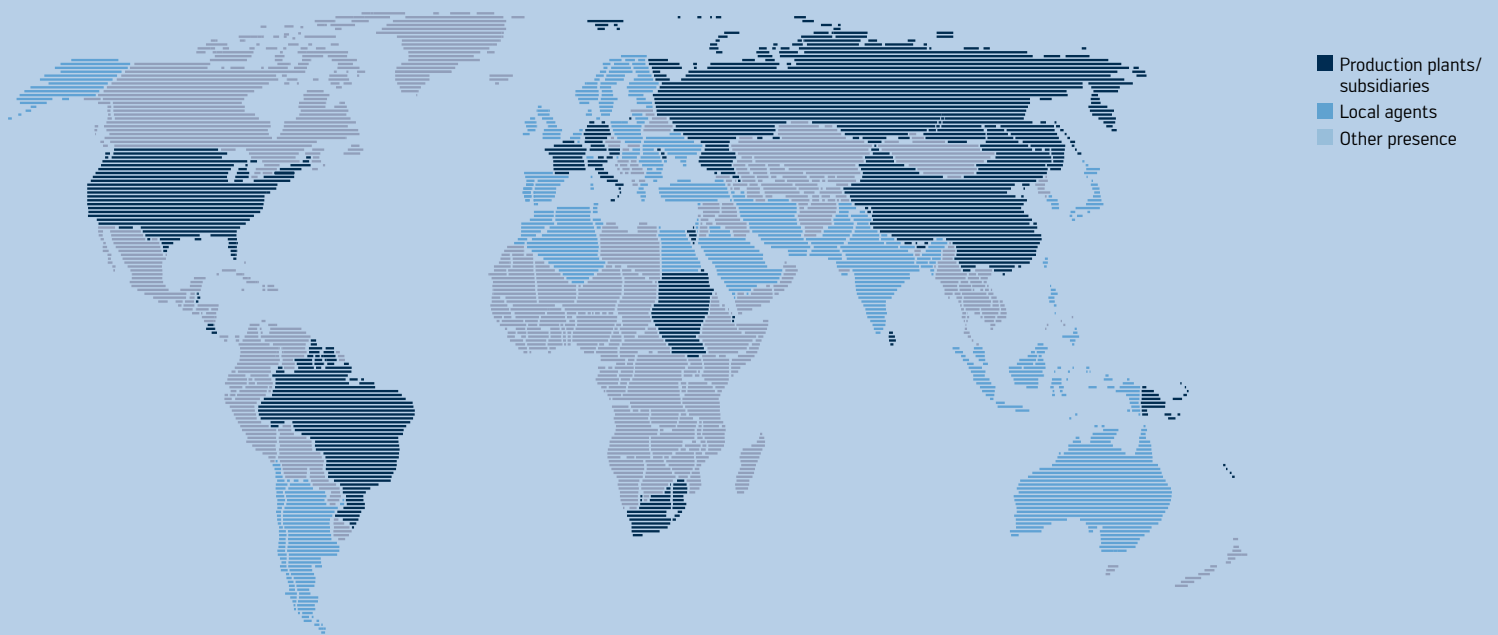

America
Kurtz Ersä, Inc.
1779 Pilgrim Road
Plymouth, WI 53073
USA
Phone +1 920 893 3772
from US: 1 800 363 3772
usa@kurtzersa.com
www.ersa.com

Mexico
Kurtz Ersä México, S.A. de C.V.
Av. Lopez Mateos Sur Núm. 1450 Int. 7
Col. Las Amapas (Plaza las Villas)
Tlajomulco de Zúñiga, Jalisco
C.P. 45643
México
Phone +52 33 15 93 18 63
info-kmx@kurtzersa.com
www.ersa.com

Asia
Kurtz Ersä Asia Ltd.
Unit 03-05, 8th Floor
One Island South
No. 2 Heung Yip Road
Wong Chuk Hang
Hong Kong
China
Phone +852 2331 2232
asia@kurtzersa.com
www.ersa.com

China
Ersä Shanghai
Room 720, Tian Xiang Building
No. 1068 Mao Tai Rd.
Shanghai 200336
China
Phone +86 213126 0818
info-esh@kurtzersa.com
www.ersa.com

Vietnam
Kurtz Ersä Vietnam Company Limited
B916 Road 3, Kizuna 2 Factory Area, Lot
B4-3-7-8
Tan Kim IP, Can Giuoc Dist. Long An Province
Vietnam
Phone +84 2723 733 682
info-kev@kurtzersa.com
www.ersa.com

Ersä France
Division de Kurtz France S.A.R.L.
15 rue de la Sucharde
21800 Chevigny Saint Sauveur
France
Phone +33 3 80 56 66 10
info-efr@kurtzersa.com
www.kurtzersa.com

Kurtz Holding GmbH & Co.
Beteiligungs KG
97892 Kreuzwertheim/Germany
info@kurtzersa.de
www.kurtzersa.com

Ersä GmbH
Leonhard-Karl-Str. 24
97877 Wertheim/Germany

Phone +49 9342 800-0
Fax +49 9342 800-127
info@ersa.de
www.ersa.com