Electronic sensors for pressure control

OsiSense XM

Catalogue



Simply easy!™

Selection guide pages 2 to 9
General pages 10 to 13

XMLK pressure transmitters for water

- **Presentation** page 14
- **Functions** page 14
- **References**
 - Pressure transmitters, sizes in bar page 15
 - Pressure transmitters, sizes in psi page 16
 - Accessories page 17

XMLG pressure transmitters

- **Presentation** page 18
- **Functions** page 18
- **References**
 - Pressure transmitters, sizes in bar pages 19 and 20
 - Accessories and replacement parts page 21

XMLP pressure transmitters

- **Presentation** page 22
- **Functions** page 23
- **References**
 - Pressure transmitters, sizes in bar pages 24 to 31
 - Pressure transmitters, sizes in psi pages 32 to 36
 - Separate parts page 37

XMEP pressure transmitters for mobile equipments

- **General presentation** pages 38 and 39
- **References**
 - Pressure transmitters, sizes in bar pages 40 and 41
 - Pressure transmitters, sizes in psi page 42
 - Separate parts page 43

ZMLP switches with 4-digit display

- **Presentation, description** page 44
- **Functions** page 44
- **References**
 - Switches with a display page 45
 - Accessories page 45

XMLR pressure sensors with 4-digit display

- **General presentation** pages 46 and 47
- **Presentation** page 48
- **Description** page 48
- **Functions** page 48
- **References**
 - Pressure sensors pages 49 to 52
 - Accessories page 53
- **Product reference index** pages 54 and 55

Electronic pressure sensors

OsiSense XM

Applications	Type of installation
	Type of sensor and features

Control circuits
Devices without display
Pressure transmitters
Analogue output, 4...20 mA or 0...10 V



Sizes	0...25 bar (0...362 psi) 0...300 psi (0...20.7 bar)
Fluids or products controlled	Air, fresh water (0...+80°C)
Fluid connection	G 1/4 A DIN 3852-E male (1) 1/4"-18 NPT male (1)
Rated supply voltage	12/24 V $\overline{\text{---}}$ (4...20 mA), 24 V $\overline{\text{---}}$ (0...10 V), SELV, PELV (2)
Voltage limits	8...33 V $\overline{\text{---}}$ (4...20 mA), 16.2...33 V $\overline{\text{---}}$ (0...10 V)
Current consumption	< 20 mA (4...20 mA), < 6 mA (0...10 V)
Electrical connection	M12, EN 175301-803-A (ex-DIN 43650A) or Packard Metri-Pack 150 connector (3)
Type of output	Analogue, 4...20 mA or 0...10 V
Materials in contact with fluid	Ceramic Al ₂ O ₃ , stainless steel type AISI 303, nitrile (NBR)
Output response time	< 2 ms
Precision including linearity, hysteresis, repeat accuracy	± 1% of the measuring range
Service life	> 10 million operating cycles
Dimensions of case (mm)	Ø 36 x 67.5
Conforming to standards	CE, ROHS, EN/IEC 61326-2-3
Product certifications	UL, CSA conforming to UL 508 and CSA-22.2 no. 14, EAC, RCM
Ambient air temperature for operation	0...+80°C
Degree of protection	IP 65 conforming to EN/IEC 60529, NEMA Type 4 conforming to UL/CSA
Vibration resistance	20 gn (9...2000 Hz) conforming to EN/IEC 60068-2-6
Shock resistance	25 gn (half sine wave 11 ms) conforming to EN/IEC 60068-2-27
Type reference	XMLK●●●B2C●●, XMLK●●●B2C●●TQ (4) XMLK●●●B2D●●, XMLK●●●B2D●●TQ (4) XMLK●●●P2C●●, XMLK●●●P2C●●TQ (4) XMLK●●●P2D●●, XMLK●●●P2D●●TQ (4) XMLK●●●P2P●●, XMLK●●●P2P●●TQ (4)
Pages	15 and 16

Other versions

(1) For other fluid connections, please consult our Customer Care Centre.
 (2) Safety extra-low voltage, Protected extra-low voltage.
 (3) For other electrical connections, please consult our Customer Care Centre.
 (4) Sold in lots of 25, minimum order quantity 50.
 (5) Phoenix Contact "Quickon" integrated connection.

Control circuits
Devices without display
Pressure transmitters
Analogue output, 4...20 mA or 0...10 V.



Sizes	- 1...400 bar (- 14.5 psi...5800 psi)
Fluids or products controlled	Fresh water (0...+125°C) Air, hydraulic oils, corrosive fluids (- 15...+125°C)
Fluid connection	G 1/4 A DIN 3852-E male or 1/4"-18 NPT male (1)
Rated supply voltage	12/24 V $\overline{\text{---}}$ (4...20 mA) 24 V $\overline{\text{---}}$ (0...10 V)
Voltage limits	8...33 V $\overline{\text{---}}$ (4...20 mA) 11.4...33 V $\overline{\text{---}}$ (0...10 V)
Current consumption	< 20 mA
Electrical connection	M12 connector (1) or integrated quick connection (5)
Type of output	Analogue, 4...20 mA or 0...10 V
Materials in contact with fluid	Ceramic Al ₂ O ₃ , stainless steel type AISI 303, FPM (Viton) PPS (Leakage protection for P > 40 bar)
Output response time	< 2 ms
Precision including linearity, hysteresis, repeat accuracy	± 0.3% of the measuring range
Service life	> 10 million operating cycles
Dimensions of case (mm)	Ø 22.8 x 58.1 (with M12 connector) Ø 22.8 x 66.1 (with quick connection)
Conforming to standards	CE, ROHS, EN/IEC 61326-2-3
Product certifications	UL, CSA conforming to UL 508 and CSA-22.2 no. 14, EAC
Ambient air temperature for operation	- 15...+85°C
Degree of protection	IP 66, IP 67 conforming to EN/IEC 60529, NEMA Type 4 conforming to UL/CSA
Vibration resistance	20 gn (9...2000 Hz) conforming to EN/IEC 60068-2-6
Shock resistance	25 gn (half sine wave 11 ms) conforming to EN/IEC 60068-2-27
Type reference	XMLG●●●D21, XMLG●●●D71 XMLG●●●D21TQ (4) XMLG●●●D71TQ (4) XMLG●●●Q21TQ (4) XMLG●●●Q71TQ (4)
Pages	19 and 20

Other versions

(1) For other fluid connections, please consult our Customer Care Centre.
 (2) Safety extra-low voltage, Protected extra-low voltage.
 (3) For other electrical connections, please consult our Customer Care Centre.
 (4) Sold in lots of 25, minimum order quantity 50.
 (5) Phoenix Contact "Quickon" integrated connection.

Electronic pressure sensors

OsiSense XM

Applications	Type of installation
	Type of sensor and features

Control circuits
Devices without display
Pressure transmitters
Analogue output, 4...20 mA, 0...10 V or ratiometric output, 0.5...4.5 V



Sizes	-1...0 bar, -1...5 bar (-14.5...72.5 psi), 0...6 bar (0...87 psi) -14.5...0 psi, -14.5...60 psi (-1...4.14 bar), 0...50 psi (0...3.45 bar)								
Fluids or products controlled	Fresh water (0...+ 125 °C) Air, hydraulic oils (- 15...+ 125 °C)								
Fluid connection	G 1/4 A DIN 3852-E male, 1/4"-18NPT male, SAE 7/16-20 UNF-2B female								
Rated supply voltage	12/24 V $\overline{\text{---}}$ (4...20 mA), 24 V $\overline{\text{---}}$ (0...10 V), 5 V $\overline{\text{---}}$ (0.5...4.5 V), SELV, PELV (1)								
Voltage limits	7...33 V $\overline{\text{---}}$ (4...20 mA), 12...33 V $\overline{\text{---}}$ (0...10 V), 4.5...5.5 V $\overline{\text{---}}$ (0.5...4.5 V)								
Current consumption	< 23 mA (4...20 mA), < 7 mA (0...10 V and 0.5...4.5 V)								
Electrical connection	M12 connector, EN 175301-803-A (ex DIN 43650A) connector, Packard Metri-Pack 150 connector or 2 m PVC cable								
Type of output	Analogue, 4...20 mA, 0...10 V or 0.5...4.5 V								
Materials in contact with fluid	Ceramic Al_2O_3 , stainless steel type AISI 316L, FPM fluorocarbon								
Output response time	< 2 ms from 10 to 90% of maximum deviation								
Precision including linearity, hysteresis, repeat accuracy	$\pm 0.5\%$ of the measuring range (except for size 0.5 bar: $\pm 1.5\%$ and size 0.25 bar: $\pm 2\%$)								
Service life	> 10 million operating cycles								
Dimensions of case (mm)	Diameter x height $\varnothing 26 \times 32.3$ (with M12 connector) $\varnothing 26 \times 55$ (with EN 175301-803-A connector) $\varnothing 26 \times 49.2$ (with Packard Metri-Pack 150 connector) $\varnothing 26 \times 57$ (with cable)								
Conforming to standards	CE, ROHS, EN/IEC 61326-2-3, NSF ANSI 61								
Product certifications	cULus conforming to UL 61010-1 and CSA-C22.2 n° 61010-1, EAC, RCM								
Ambient air temperature for operation	- 30...+ 85 °C								
Degree of protection	IP 65 or IP 67 conforming to EN/IEC 60529 IP 69K conforming to EN/IEC 60529 (versions with M12 connector)								
Vibration resistance	20 gn (15...2000 Hz) conforming to EN/IEC 60068-2-6								
Shock resistance	100 gn (half sine wave 11 ms) conforming to EN/IEC 60068-2-27								
Type reference	<table border="0"> <tr> <td>XMLP●●●●D●●F</td> <td>XMLP●●●●D●●FQ (2)</td> </tr> <tr> <td>XMLP●●●●C●●F</td> <td>XMLP●●●●C●●FQ (2)</td> </tr> <tr> <td>XMLP●●●●L●●F</td> <td>XMLP●●●●L●●FQ (2)</td> </tr> <tr> <td>XMLP●●●●R●●3F</td> <td>XMLP●●●●R●●3FQ (2)</td> </tr> </table>	XMLP●●●●D●●F	XMLP●●●●D●●FQ (2)	XMLP●●●●C●●F	XMLP●●●●C●●FQ (2)	XMLP●●●●L●●F	XMLP●●●●L●●FQ (2)	XMLP●●●●R●●3F	XMLP●●●●R●●3FQ (2)
XMLP●●●●D●●F	XMLP●●●●D●●FQ (2)								
XMLP●●●●C●●F	XMLP●●●●C●●FQ (2)								
XMLP●●●●L●●F	XMLP●●●●L●●FQ (2)								
XMLP●●●●R●●3F	XMLP●●●●R●●3FQ (2)								
Pages	24 to 36								

(1) Safety extra-low voltage, Protected extra-low voltage.
(2) Sold in lots of 25.

Control circuits
Devices without display
Pressure transmitters
Analogue output, 4...20 mA, 0...10 V or ratiometric output, 0.5...4.5 V



Sizes	- 1...9 bar (- 14.5...130 psi), 0...600 bar (0...8700 psi), 0...6,000 psi (0 bar...414 bar)						
Fluids or products controlled	Fresh water (0...+ 135 °C) Air, hydraulic oils, refrigeration fluids (- 30...+ 135 °C)						
Fluid connection	G 1/4 A DIN 3852-E male, SAE 7/16-20 UNF-2A male, SAE 7/16-20 UNF-2B female or 1/4"-18 NPT male						
Rated supply voltage	12/24 V $\overline{\text{---}}$ (4...20 mA), 24 V $\overline{\text{---}}$ (0...10 V), 5 V $\overline{\text{---}}$ (0.5...4.5 V), SELV, PELV (1)						
Voltage limits	7...33 V $\overline{\text{---}}$ (4...20 mA), 12...33 V $\overline{\text{---}}$ (0...10 V), 4.5...5.5 V $\overline{\text{---}}$ (0.5...4.5 V)						
Current consumption	< 23 mA (4...20 mA), < 7 mA (0...10 V), < 7 mA (0.5...4.5 V)						
Electrical connection	M12, EN 175301-803-A (ex-DIN 43650A) or Packard Metri-Pack 150 connector						
Type of output	Analogue, 4...20 mA, 0...10 V or 0.5...4.5 V						
Materials in contact with fluid	Stainless steel type AISI 316L, FPM fluorocarbon						
Output response time	< 2 ms from 10% to 90% of maximum deviation						
Precision including linearity, hysteresis, repeat accuracy	$\pm 0.5\%$ of the measuring range						
Service life	> 10 million operating cycles						
Dimensions of case (mm)	$\varnothing 26 \times 38$ (with M12 connector) $\varnothing 26 \times 60.5$ (with EN 175301-803-A connector) $\varnothing 26 \times 55$ (with Packard Metri-Pack 150 connector)						
Conforming to standards	CE, ROHS, EN/IEC 61326-2-3, NSF ANSI 61						
Product certifications	cULus conforming to UL 61010-1 and CSA-C22.2 no. 61010-1, EAC, RCM						
Ambient air temperature for operation	- 30...+ 85 °C						
Degree of protection	IP 65 or IP 67 conforming to EN/IEC 60529 IP 69K conforming to EN/IEC 60529 (versions with M12 connector)						
Vibration resistance	20 gn (15...2000 Hz) conforming to EN/IEC 60068-2-6						
Shock resistance	100 gn (half sine wave 11 ms) conforming to EN/IEC 60068-2-27						
Type reference	<table border="0"> <tr> <td>XMLP●●●●B●●1F</td> <td>XMLP●●●●B●●1FQ (2)</td> </tr> <tr> <td>XMLP●●●●B●●0</td> <td>XMLP●●●●B●●0Q (2)</td> </tr> <tr> <td>XMLP●●●●P●●30</td> <td>XMLP●●●●P●●30Q (2)</td> </tr> </table>	XMLP●●●●B●●1F	XMLP●●●●B●●1FQ (2)	XMLP●●●●B●●0	XMLP●●●●B●●0Q (2)	XMLP●●●●P●●30	XMLP●●●●P●●30Q (2)
XMLP●●●●B●●1F	XMLP●●●●B●●1FQ (2)						
XMLP●●●●B●●0	XMLP●●●●B●●0Q (2)						
XMLP●●●●P●●30	XMLP●●●●P●●30Q (2)						
Pages	24 to 36						

Electronic pressure sensors

OsiSense XM for mobile equipment

Applications	Type of installation
	Type of sensor and features

Control circuits
Devices without display
Pressure transmitters
Analogue output, 4...20 mA, 0...10 V or ratiometric output, 0.5...4.5 V



Sizes	0...60 bar (0...870 psi), 0...100 bar (0...1450 psi), 0...250 bar (0...3625 psi) 0...400 bar (0...5800 psi), 0...600 bar (0...8700 psi)	
Fluids or products controlled	Hydraulic oils, air, fresh water, gas (-40...+125 °C)	
Fluid connection	G 1/4 A DIN 3852-E male	
Rated supply voltage	12/24 V $\ddot{=}$ (4...20 mA), 24 V $\ddot{=}$ (0...10 V), 5 V $\ddot{=}$ (0.5...4.5 V), SELV, PELV (1)	
Voltage limits	9...36 V $\ddot{=}$ (4...20 mA), 12...36 V $\ddot{=}$ (0...10 V), 4.5...5.5 V $\ddot{=}$ (0.5...4.5 V)	
Current consumption	< 23 mA (4...20 mA), < 7 mA (0...10 V and 0.5...4.5 V)	
Electrical connection	M12 connector (4-pin)	Deutsch DT04-3P connector (3-pin)
Type of output	Analogue, 4...20 mA, 0...10 V or 0.5...4.5 V	
Materials in contact with fluid	Stainless steel type AISI 316L	
Output response time	< 2 ms from 10 to 90% of maximum deviation	
Precision including linearity, hysteresis, repeat accuracy	± 0.5% of the measuring range	
Service life	> 10 million operating cycles	
Dimensions of case (mm)	Diameter x height	Ø 24 x 38.1 Ø 24 x 62.1
Conforming to standards	CE, ROHS, EN/IEC 61326-2-3, ECE 10R-5, ISO 13766, ISO 14982, EN 13309	
Product certifications	cULus conforming to UL 61010-1 E2 conforming to UNECE 10R-5 (pending)	
Ambient air temperature for operation	-40...+100 °C	
Degree of protection	IP 65, IP 67 and IP 69K conforming to EN/IEC 60529	
Vibration resistance	12 gn sine wave (20 to 520 Hz) and 18 gn random (10 to 2000 Hz) conforming to ISO 16750-3 Test 4	
Shock resistance	50 gn (11 ms half sine wave) conforming to IEC 60068-2-27	
Type reference	XMEP●●0BD●1F XMEP●●0BD●1FQ (2)	XMEP●●0BT●1F XMEP●●0BT●1FQ (2)
Pages	40 and 41	

Other versions (1) Safety extra-low voltage, Protected extra-low voltage.
(2) Sold in lots of 25.

Control circuits
Devices without display
Pressure transmitters
Analogue output, 4...20 mA, 0...10 V or ratiometric output, 0.5...4.5 V



Sizes	0...60 bar (0...870 psi), 0...100 bar (0...1450 psi), 0...250 bar (0...3625 psi) 0...400 bar (0...5800 psi), 0...600 bar (0...8700 psi)	0...1000 psi (0...69 bar), 0...3000 psi (0...207 bar), 0...5000 psi (0...345 bar), 0...7500 psi (0...517 bar)
Fluids or products controlled	Hydraulic oils, air, fresh water, gas (-40...+125 °C)	
Fluid connection	G 1/4 A DIN 3852-E male	1/4"-18NPT male
Rated supply voltage	12/24 V $\ddot{=}$ (4...20 mA), 24 V $\ddot{=}$ (0...10 V), 5 V $\ddot{=}$ (0.5...4.5 V), SELV, PELV (1)	
Voltage limits	9...36 V $\ddot{=}$ (4...20 mA), 12...36 V $\ddot{=}$ (0...10 V), 4.5...5.5 V $\ddot{=}$ (0.5...4.5 V)	
Current consumption	< 23 mA (4...20 mA), < 7 mA (0...10 V and 0.5...4.5 V)	
Electrical connection	AMP Superseal 1.5 connector (3-pin)	AMP Junior Power Timer connector (3-pin)
Type of output	Analogue, 4...20 mA, 0...10 V or 0.5...4.5 V	
Materials in contact with fluid	Stainless steel type AISI 316L	
Output response time	< 2 ms from 10 to 90% of maximum deviation	
Precision including linearity, hysteresis, repeat accuracy	± 0.5% of the measuring range	
Service life	> 10 million operating cycles	
Dimensions of case (mm)	Ø 24 x 60.5	Ø 24 x 54 Ø 24 x 60
Conforming to standards	CE, ROHS, EN/IEC 61326-2-3, ECE 10R-5, ISO 13766, ISO 14982, EN 13309	
Product certifications	cULus conforming to UL 61010-1 E2 conforming to UNECE 10R-5 (pending)	
Ambient air temperature for operation	-40...+100 °C	
Degree of protection	IP 65 and IP 67 conforming to EN/IEC 60529	IP 65, IP 67 and IP 69K conforming to EN/IEC 60529
Vibration resistance	12 gn sine wave (20 to 520 Hz) and 18 gn random (10 to 2000 Hz) conforming to ISO 16750-3 Test 4	
Shock resistance	50 gn (11 ms half sine wave) conforming to IEC 60068-2-27	
Type reference	XMEP●●0BV●1F XMEP●●0BV●1FQ (2)	XMEP●●0BJ●1F XMEP●●0BJ●1FQ (2)
Pages	40 and 41	42

Other versions (1) Safety extra-low voltage, Protected extra-low voltage.
(2) Sold in lots of 25.

Electronic pressure sensors

OsiSense XM

Applications	Type of installation
	Type reference and features

Control circuits
Switches with 4-digit display
- With an analogue output, 4...20 mA and a switching output, PNP or NPN type
- With two PNP or NPN switching outputs



Sizes	-		
Fluids or products controlled	-		
Fluid connection	-		
Display	7 segment/4-digit display. Pressure units in bar, psi or pascal. 41 display ranges can be selected, from -14.5 to 6000		
Rated supply voltage	24 V $\overline{\text{---}}$, SELV, PELV (1)		
Voltage limits	17...33 V $\overline{\text{---}}$		
Current consumption	\leq 50 mA		
Electrical connection	M12, 4-pin connector		
Type of output	<table border="0"> <tr> <td>■ Analogue, 4...20 mA + one switching output, PNP or NPN, 200 mA</td> <td>■ 2 switching outputs, PNP or NPN, 200 mA</td> </tr> </table>	■ Analogue, 4...20 mA + one switching output, PNP or NPN, 200 mA	■ 2 switching outputs, PNP or NPN, 200 mA
■ Analogue, 4...20 mA + one switching output, PNP or NPN, 200 mA	■ 2 switching outputs, PNP or NPN, 200 mA		
Materials in contact with fluid	-		
Output response time	\leq 3 ms		
Precision including linearity, hysteresis, repeat accuracy	\pm 1% of the measuring range		
Service life	> 10 million operating cycles		
Dimensions of case (mm)	Width x height x depth 41 x 77 x 42		
Conforming to standards	CE, ROHS, EN/IEC 61000-6-2, EN/IEC 61000-6-4		
Product certifications	cULus conforming to UL 508 and CSA-C22.2 no. 14, EAC, RCM		
Ambient air temperature for operation	-25...+70°C		
Degree of protection	IP 65 or IP 67 conforming to EN/IEC 60529, IP 69K conforming to DIN 40050		
Vibration resistance	5 gn (10...2000 Hz) conforming to EN/IEC 60068-2-6		
Shock resistance	25 gn conforming to EN/IEC 60068-2-27		
Type reference	ZMLPA1•2S● ZMLPA2•0SH		
Pages	45		

(1) Safety extra-low voltage, Protected extra-low voltage.
(2) For other fluid connections, please consult our Customer Care Centre.

Control circuits
Pressure transmitters with 4-digit display
- With one analogue output, 4...20 mA or 0...10 V and one input for diagnosis
Pressure and vacuum switches with 4-digit display
- With one analogue output, 4...20 mA or 0...10 V and one switching output, PNP or NPN type
- With two switching outputs, PNP or NPN type
- With one analogue output, 4...20 mA, and two switching outputs, PNP or NPN type



Sizes	- 1...600 bar (-14.5 psi...8700 psi)						
Fluids or products controlled	Fresh water (0...+80°C), Air, hydraulic oils, refrigeration fluids (-20...+80°C)						
Fluid connection	G 1/4 A DIN3852-Y female, 1/4"-18 NPT female or SAE 7/16-20 UNF female (2)						
Display	7-segment/4-digit display. Pressure units in bar, psi or pascal. Signalling LED for the pressure unit and output state.						
Rated supply voltage	24 V $\overline{\text{---}}$, SELV, PELV (1)						
Voltage limits	17...33 V $\overline{\text{---}}$						
Current consumption	\leq 50 mA						
Electrical connection	M12, 4-pin connector						
Type of output	<table border="0"> <tr> <td>■ Analogue, 4...20 mA or 0...10 V</td> <td>■ Analogue, 4...20 mA or 0...10 V + one switching output, PNP or NPN, 250 mA</td> </tr> <tr> <td></td> <td>■ Two switching outputs, PNP or NPN, 250 mA</td> </tr> <tr> <td></td> <td>■ Analogue, 4...20 mA + two switching outputs, PNP or NPN, 250 mA</td> </tr> </table>	■ Analogue, 4...20 mA or 0...10 V	■ Analogue, 4...20 mA or 0...10 V + one switching output, PNP or NPN, 250 mA		■ Two switching outputs, PNP or NPN, 250 mA		■ Analogue, 4...20 mA + two switching outputs, PNP or NPN, 250 mA
■ Analogue, 4...20 mA or 0...10 V	■ Analogue, 4...20 mA or 0...10 V + one switching output, PNP or NPN, 250 mA						
	■ Two switching outputs, PNP or NPN, 250 mA						
	■ Analogue, 4...20 mA + two switching outputs, PNP or NPN, 250 mA						
Materials in contact with fluid	\leq 40 bar: Ceramic Al_2O_3 , stainless steel 316L, FPM fluorocarbon \geq 100 bar: Stainless steel 316L, FKM fluorocarbon (Viton)						
Output response time	\leq 10 ms						
Precision including linearity, hysteresis, repeat accuracy	\pm 1% of the measuring range						
Service life	> 10 million operating cycles						
Dimensions of case (mm)	41 x 93 x 42						
Conforming to standards	CE, ROHS, EN/IEC 61326-2-3, NSF ANSI 61						
Product certifications	cULus conforming to UL 61010-1 and CSA-C22.2 no. 61010-1, EAC, RCM						
Ambient air temperature for operation	-20...+80°C						
Degree of protection	IP 66, IP 67 conforming to EN/IEC 60529						
Vibration resistance	20 gn (10...2000 Hz) conforming to EN/IEC 60068-2-6						
Shock resistance	50 gn conforming to EN/IEC 60068-2-27						
Type reference	XMLR●●●G0●●● XMLR●●●G1●●●, XMLR●●●G2●●● XMLR●●●M0●●● XMLR●●●M1●●●, XMLR●●●M2●●●						
Pages	49 to 52						

(1) Safety extra-low voltage, Protected extra-low voltage.
(2) For other fluid connections, please consult our Customer Care Centre.

Electronic pressure sensors

OsiSense XM

For control circuits

Functions

Electronic pressure sensors

The function of electronic pressure sensors is the control and measurement of pressure or vacuum levels in hydraulic or pneumatic systems. Being electronic, the sensors have no mechanical moving parts.

Pressure transmitters

Pressure transmitters convert the pressure into an electrical signal which is proportional to the applied pressure. Their high precision makes them suitable for all industrial applications requiring pressure/vacuum display, control or regulation.

Being very robust, they are equally suitable for applications involving high operating rates.

Pressure and vacuum switches

Electronic pressure switches and vacuum switches convert a change in pressure into a digital electrical signal when the switching points which have been set are reached.

They are distinguished from electromechanical pressure switches and vacuum switches by their very wide switching adjustment ranges.

Their robustness, together with their excellent adherence to the set values over a period of time, make them ideal for applications involving high operating rates. In addition, the high repeat accuracy and fast response time of these sensors make them equally suitable for applications requiring accurate pressure regulation and monitoring.

Note: Some sensors in the OsiSense XM ranges have both one analogue output and one or two digital outputs.

Operating principle

Pressure transmitters

These devices provide an analogue output which has a signal proportional to the pressure applied to the sensor. Depending on the model, this signal can be 4...20 mA, 0...10 V or 0.5...4.5 V.

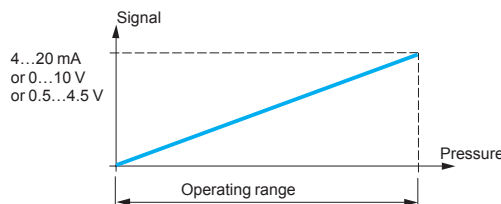

Pressure and vacuum switches

These devices have one or two digital outputs depending on the model. The status of these outputs is defined by high (SP) and low (rP) switching points which can usually be independently adjusted.

Pressure switches and vacuum switches can have 2 different switching modes:

- Hysteresis mode, particularly suited to pumping applications (filling/emptying).
- Window mode, more suitable for applications where the pressure is regulated.

The switching outputs can usually be configured as normally open (NO) or normally closed (NC).

In addition, for the OsiSense XMLR range (1), output switching can be delayed for between 1 and 50 seconds, both on the pressure rising edge and falling edge.

(1) See pages 46 to 53.

Electronic pressure sensors

OsiSense XM

For control circuits

Operating principle (continued)

Pressure and vacuum switches (continued)

Switching output: hysteresis mode

Hysteresis mode is generally used for pumping and/or emptying applications.

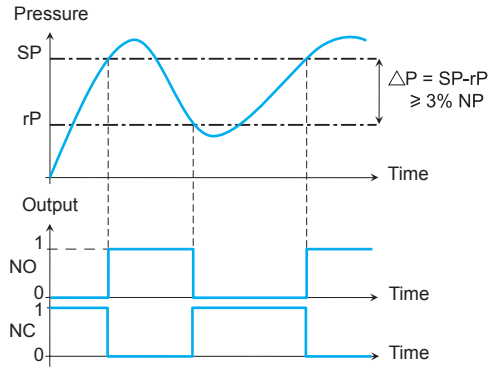

SP: High switching point
 rP: Low switching point
 NP: Nominal pressure

Switching output: Window mode

Window mode is generally used for pressure regulation applications.

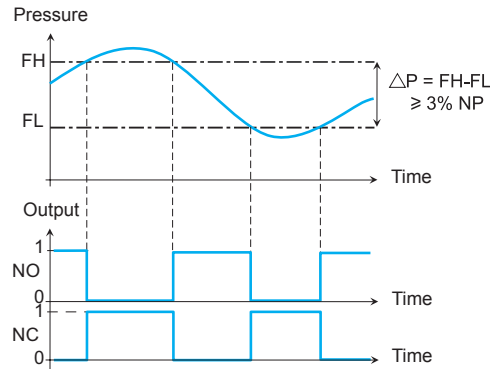

FH: High switching point
 FL: Low switching point
 NP: Nominal pressure

Switching output: time delay mode

Time delay mode is generally used to filter fast transient pressures. The output only switches after a "dS" and "dr" time period which can be set between 0 and 50 seconds.

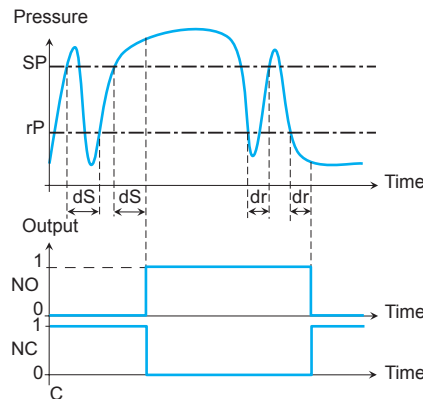

FH: High switching point
 FL: Low switching point
 NP: Nominal pressure

Electronic pressure sensors

OsiSense XM

For control circuits

Terminology

Nominal pressure NP or size

The nominal pressure is the maximum pressure or vacuum which can be measured by the sensor.

Maximum permissible accidental pressure

This is the maximum pressure, excluding pressure surges, to which the pressure sensor can occasionally be subjected without being damaged.

Destruction pressure

The pressure value which if exceeded is likely to cause serious damage to the sensor i.e. leaking, bursting, component failure, etc.

High switching point (SP)

This is the upper pressure setting selected on the pressure or vacuum switch at which the electrical output changes state when this pressure value is reached.

Low switching point (rP)

This is the lower pressure setting selected on the pressure or vacuum switch at which the electrical output changes state when this pressure value is reached.

Precision

The sensor's overall precision is the result of several error sources linked to linearity, hysteresis, repeat accuracy and setting tolerances. It is expressed as a % of the nominal pressure.

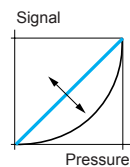

The linearity is the maximum deviation between the actual transmitter curve and the nominal curve.

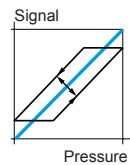

The hysteresis is the maximum deviation between the rising pressure curve and the falling pressure curve.

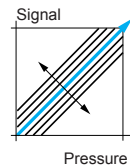

The repeat accuracy is the maximum drift encountered after several successive pressure variation cycles.

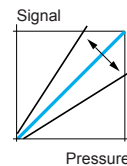
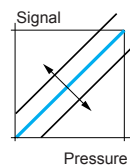

The setting tolerances are the calibration tolerances regarding the zero point and sensitivity set during sensor manufacture (gradient of output signal curve from the pressure transmitter).

Temperature drift

Although the pressure sensor is compensated electronically, its accuracy is still slightly influenced by the temperature to which it is subjected.

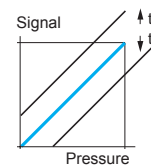

Zero point drift

This is proportional to the temperature and is expressed as % NP/°C.

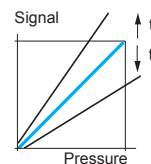

Sensitivity drift

This is proportional to the temperature and is expressed as % NP/°C.

(NP: Nominal pressure)

Electronic pressure sensors

OsiSense XM

For control circuits

Main criteria for selecting an electronic pressure sensor

The fluid or gas to be controlled

Our products, including the materials used, are compatible with the majority of fluids or gases encountered in industrial applications.

However some particularly corrosive fluids (sea water, for example) can affect product operation sooner or later.

The fluid temperature can also be an aggravating factor.

The materials in contact with the fluid are described in the technical data sheets which can be found on our website, www.tesensors.com.

If in doubt about compatibility, contact our Customer Care Centre.

The maximum pressure of the fluid to be controlled

The maximum pressure of the fluid to be controlled will determine the nominal pressure (or size) of the product to be used.

Our product ranges include a number of sizes which cover a pressure range from -1 to 600 bar.

It is advisable to choose a size just above the maximum pressure to be controlled, in order to have the best possible accuracy.

However, sometimes it is necessary to take account of transient pressure surges caused by the system operation (for example: the phenomenon of water hammer) and choose a size well above the maximum pressure to be controlled.

The fluid entry

There are a number of formats for the fluid and pneumatic connections.

Our ranges have the 3 most common types of fluid entry:

- G 1/4
- 1/4" - 18 NPT
- SAE 7/16-20UNF

The type and configuration of the electrical output(s)

Depending on the product range, each sensor reference has one, two or three outputs which may be analogue or digital.

It is important to clearly identify the function(s) the pressure sensor has to fulfil in the control system, in order to select the correct product.

The electrical connection

All products in the OsiSense XM ranges offer connection via an M12 x 1, 4 or 5-pin male cylindrical connector.

Some pressure transmitters also have an EN 175301-803-A or Packard Metri-Pack 150 connector.

We recommend connecting our pressure sensors by means of our OsiSense XZ cabling accessories.

Electronic pressure sensors

OsiSense XM

XMLK pressure transmitters

Plastic body, stainless steel 303 fluid entry.

With analogue output

Presentation

XMLK pressure transmitters are characterised by their ceramic pressure measuring cell.

The deformation caused by the pressure is transmitted to the resistors of a Wheatstone bridge screen-printed on the ceramic.

The change in resistance is then processed by the integrated electronics, giving an analogue output signal.

The stainless steel AISI 303 fluid entry and the ceramic cell combined with a nitrile gasket make these transmitters particularly suitable for fluids such as air and fresh water, for temperatures between 0 and + 80°C.

Depending on the model, these devices are supplied:

- With 12 or 24 V $\overline{\text{DC}}$ nominal and operate from 8 to 33 V $\overline{\text{DC}}$ for transmitters with 4...20 mA output
- With 24 V $\overline{\text{DC}}$ nominal and operate from 11.4 to 33 V $\overline{\text{DC}}$ for transmitters with a 0...10 V output

These products have IP 67 and Nema type 4 degree of protection.

In addition to their plastic case and the pressure ratings available, they constitute the optimised solution for water pumping applications.

Description

- 1 Electrical connection: M12 male, EN 175301-803-A or Packard Metri-Pack 150.
- 2 Plastic case.
- 3 Electronics: 4...20 mA or 0...10 V analogue output.
- 4 Ceramic pressure measuring cell.
- 5 Nitrile gasket.
- 6 Fluid entry: G 1/4 male or 1/4" - 18 NPT male.

Functions

Versions with an M12 electrical connector and 4...20 mA analogue output (XMLK●●●●2D2●) can be used with switches with ZMLP 4-digit display (1).

The pressure ranges available are:

- 0...6 bar to 0...25 bar
- 0...100 psi to 0...300 psi

The selling in lots option offers an excellent price/performance ratio (sold individually or in lots of 25).

XMLK electronic pressure sensors are, therefore, mainly intended for machine manufacturers.

(1) See pages 44 and 45.

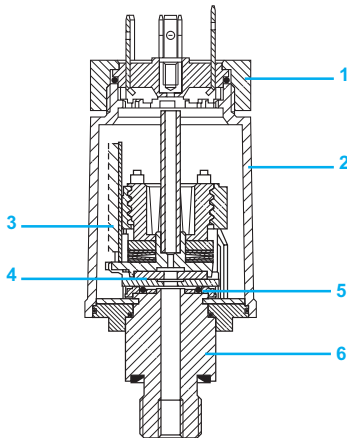

Electronic pressure sensors

OsiSense XM

XMLK pressure transmitters

Plastic body, stainless steel 303 fluid entry.

With analogue output. Sizes in bar



XMLK●●●B2D●1



XMLK●●●B2C●1

0 to 6 bar (0 to 87 psi)

Maximum permissible accidental pressure: 12 bar, destruction pressure: 18 bar

Analogue output type	Electrical connection	Reference (1)	Weight kg
G 1/4 A (male) fluid connection			
4...20 mA	M12	XMLK006B2D21	0.110
	EN 175301-803-A	XMLK006B2C21 (2)	0.110
0...10 V	M12	XMLK006B2D71	0.110
	EN 175301-803-A	XMLK006B2C71	0.110

0 to 10 bar (0 to 145 psi)

Maximum permissible accidental pressure: 20 bar, destruction pressure: 30 bar

Analogue output type	Electrical connection	Reference (1)	Weight kg
G 1/4 A (male) fluid connection			
4...20 mA	M12	XMLK010B2D21 (2)	0.110
	EN 175301-803-A	XMLK010B2C21 (2)	0.110
0...10 V	M12	XMLK010B2D71	0.110
	EN 175301-803-A	XMLK010B2C71	0.110

0 to 16 bar (0 to 232 psi)

Maximum permissible accidental pressure: 32 bar, destruction pressure: 48 bar

Analogue output type	Electrical connection	Reference (1)	Weight kg
G 1/4 A (male) fluid connection			
4...20 mA	M12	XMLK016B2D21	0.110
	EN 175301-803-A	XMLK016B2C21 (2)	0.110
0...10 V	M12	XMLK016B2D71	0.110
	EN 175301-803-A	XMLK016B2C71	0.110

0 to 25 bar (0 to 362.5 psi)

Maximum permissible accidental pressure: 50 bar, destruction pressure: 75 bar

Analogue output type	Electrical connection	Reference (1)	Weight kg
G 1/4 A (male) fluid connection			
4...20 mA	M12	XMLK025B2D21 (2)	0.110
	EN 175301-803-A	XMLK025B2C21 (2)	0.110
0...10 V	M12	XMLK025B2D71	0.110

(1) For other electrical or fluid connections, or types of output, please consult our Customer Care Centre.

(2) Sold in lots of 25. Add TQ to the end of the reference selected.
Example: XMLK006B2C21 becomes XMLK006B2C21TQ. Minimum quantity 50.

Electronic pressure sensors

OsiSense XM

XMLK pressure transmitters

Plastic body, stainless steel 303 fluid entry.

With analogue output. Sizes in psi



XMLK●●0P2D●3



XMLK●●0P2C●3



XMLK●●0P2P●3

0 to 100 psi (0 to 6.9 bar)

Maximum permissible accidental pressure: 200 psi, destruction pressure: 300 psi

Analogue output type	Electrical connection	Reference (1)	Weight kg
1/4" - 18 NPT (male) fluid connection			
4...20 mA	M12	XMLK100P2D23 (2)	0.110
	EN 175301-803-A	XMLK100P2C23 (2)	0.110
	Packard Metri-Pack 150	XMLK100P2P23 (2)	0.110
0...10 V	M12	XMLK100P2D73	0.110
	EN 175301-803-A	XMLK100P2C73	0.110

0 to 150 psi (0 to 10.3 bar)

Maximum permissible accidental pressure: 300 psi, destruction pressure: 450 psi

Analogue output type	Electrical connection	Reference (1)	Weight kg
1/4" - 18 NPT (male) fluid connection			
4...20 mA	M12	XMLK150P2D23	0.110
	EN 175301-803-A	XMLK150P2C23	0.110
	Packard Metri-Pack 150	XMLK150P2P23	0.110
0...10 V	M12	XMLK150P2D73	0.110
	EN 175301-803-A	XMLK150P2C73	0.110

0 to 200 psi (0 to 13.8 bar)

Maximum permissible accidental pressure: 400 psi, destruction pressure: 600 psi

Analogue output type	Electrical connection	Reference (1)	Weight kg
1/4" - 18 NPT (male) fluid connection			
4...20 mA	M12	XMLK200P2D23	0.110
	EN 175301-803-A	XMLK200P2C23 (2)	0.110
	Packard Metri-Pack 150	XMLK200P2P23	0.110
0...10 V	M12	XMLK200P2D73	0.110
	EN 175301-803-A	XMLK200P2C73	0.110

0 to 300 psi (0 to 20.7 bar)

Maximum permissible accidental pressure: 600 psi, destruction pressure: 900 psi

Analogue output type	Electrical connection	Reference (1)	Weight kg
1/4" - 18 NPT (male) fluid connection			
4...20 mA	M12	XMLK300P2D23	0.110
	EN 175301-803-A	XMLK300P2C23 (2)	0.110
	Packard Metri-Pack 150	XMLK300P2P23 (2)	0.110
0...10 V	M12	XMLK300P2D73	0.110
	EN 175301-803-A	XMLK300P2C73	0.110

(1) For other electrical or fluid connections, or types of output, please consult our Customer Care Centre.

(2) Sold in lots of 25. Add TQ to the end of the reference selected.

Example: XMLK200P2D23 becomes XMLK200P2D23TQ. Minimum quantity 50.

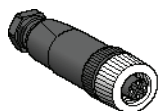

XZCC12FDM40B

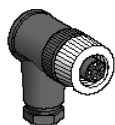

XZCC12FCM40B



XZCC43FCP40B

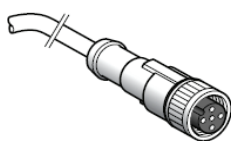

XZCP1141L10

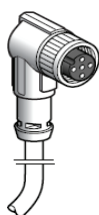

XZCP1241L5

Connection accessories

Description	Type	Reference	Weight kg
M12 female connector metal clamping ring (1)	Straight	XZCC12FDM40B	0.020
	Elbowed	XZCC12FCM40B	0.020

Female connector EN 175301-803-A (1)	–	XZCC43FCP40B	0.035
--------------------------------------	---	--------------	-------

Description	Length of cable	Reference	Weight kg
Pre-wired M12, straight, female connectors	2 m	XZCP1141L2	0.090
	5 m	XZCP1141L5	0.190
	10 m	XZCP1141L10	0.370
Pre-wired M12, elbowed, female connectors	2 m	XZCP1241L2	0.090
	5 m	XZCP1241L5	0.190
	10 m	XZCP1241L10	0.370

(1) Connector with screw terminal connections.

Electronic pressure sensors

OsiSense XM

XMLG pressure transmitters

Metal body, stainless steel 303 fluid entry

With analogue or solid-state output

Presentation

XMLG pressure transmitters are characterised by their ceramic pressure measuring cell.

The deformation caused by the pressure is transmitted to the resistors of a Wheatstone bridge screen-printed on the ceramic.

The change in resistance is then processed by the integrated electronics, giving either a digital or analogue output signal.

The stainless steel AISI 303 body and the ceramic cell combined with a viton gasket make these products compatible with industrial fluids such as:

- Air
- Fresh water
- Hydraulic oils

XMLG pressure sensors can control fluids from -15 to + 125°C.

Depending on the model, these sensors are supplied:

- With 12 or 24 V $\overline{\text{DC}}$ nominal and operate from 8 to 33 V $\overline{\text{DC}}$ for transmitters with 4...20 mA output,
- With 24 V $\overline{\text{DC}}$ nominal and operate from 11.4 to 33 V $\overline{\text{DC}}$ for transmitters with a 0...10 V output.

Offered with IP 67 and Nema type 4 degree of protection, these compact products, which offer excellent EMC characteristics and typical precision better than 0.3 %, are particularly suitable for the most demanding industrial applications.

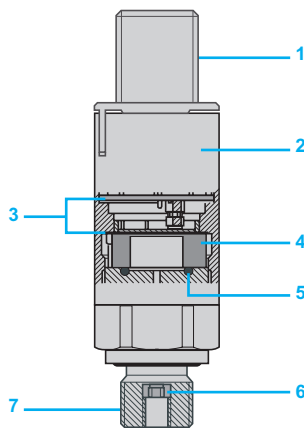

Description

- 1 Electrical connection: M12 male or quick connection for cable.
- 2 Metal case made of stainless steel 303.
- 3 Electronics with EMC protection.
- 4 Ceramic pressure measuring cell.
- 5 FPM (Viton) gasket.
- 6 Leakage protection (on sizes \geq 40 bar).
- 7 Fluid entry: G 1/4 male or 1/4" - 18 NPT male.

Functions

Pressure transmitters have an 4...20 mA or 0...10 V analogue output, which is proportional to the measuring range.

Versions with an M12 electrical connector and 4...20 mA analogue output (XMLG●●●D2●) can be used with switches with a 4-digit ZMLP display (1).

The pressure ranges offered are:

- - 1...0 bar
- 0...400 bar

An anti-leakage system integrated in products for pressures \geq 40 bar, prevents fluid leakage in the event of the measuring cell destruction pressure being exceeded.

Important ordering requirement

XMLG pressure transmitters are sold individually or in lots of 50.

(1) See pages 44 and 45.

Electronic pressure sensors

OsiSense XM

XMLG pressure transmitters

Metal body, stainless steel 303 fluid entry

With analogue output. Sizes in bar



XMLG●●●D●●●



XMLG●●●Q●●●

-1 to 0 bar (-14.5 to 0 psi)

Maximum permissible accidental pressure: 2.7 bar, destruction pressure: 3 bar

Analogue output type	Electrical connection	Reference (1)	Weight kg
G 1/4 A (male) fluid connection			
4...20 mA	M12	XMLGM01D21 (2)	0.095
0...10 V	M12	XMLGM01D71	0.095
1/4"- 18 NPT (male) fluid connection			
4...20 mA	M12	XMLGM01D23 (2)	0.095
0...10 V	M12	XMLGM01D73TQ (3)	0.095

0 to 1 bar (0 to 14.5 psi)

Maximum permissible accidental pressure: 2.7 bar, destruction pressure: 3 bar

Analogue output type	Electrical connection	Reference (1)	Weight kg
G 1/4 A (male) fluid connection			
4...20 mA	M12	XMLG001D21 (2)	0.095
0...10 V	M12	XMLG001D71 (2)	0.095
1/4"- 18 NPT (male) fluid connection			
4...20 mA	M12	XMLG001D23 (2)	0.095
0...10 V	M12	XMLG001D73TQ (3)	0.095

0 to 6 bar (0 to 87 psi)

Maximum permissible accidental pressure: 17.6 bar, destruction pressure: 20 bar

Analogue output type	Electrical connection	Reference (1)	Weight kg
G 1/4 A (male) fluid connection			
4...20 mA	M12	XMLG006D21	0.095
0...10 V	M12	XMLG006D71	0.095
1/4"- 18 NPT (male) fluid connection			
4...20 mA	M12	XMLG006D23	0.095
0...10 V	M12	XMLG006D73TQ (3)	0.095

0 to 10 bar (0 to 145 psi)

Maximum permissible accidental pressure: 22 bar, destruction pressure: 25 bar

Analogue output type	Electrical connection	Reference (1)	Weight kg
G 1/4 A (male) fluid connection			
4...20 mA	M12	XMLG010D21 (2)	0.095
	Integrated connection (4)	XMLG010Q21TQ (3)	0.095
0...10 V	M12	XMLG010D71 (2)	0.095
	Integrated connection (4)	XMLG010Q71TQ (3)	0.095
1/4"- 18 NPT (male) fluid connection			
4...20 mA	M12	XMLG010D23 (2)	0.095
0...10 V	M12	XMLG010D73	0.095

(1) For other electrical or fluid connections, or types of output, please consult our Customer Care Centre.

(2) Sold in lots of 25. Minimum quantity 50. Add TQ to the end of the reference selected. Example: XMLG001D21 becomes XMLG001D21TQ.

(3) Sold only in lots of 25. Minimum quantity 50.

(4) Phoenix Contact "Quickon" type integrated quick connection.

Electronic pressure sensors

OsiSense XM

XMLG pressure transmitters

Metal body, stainless steel 303 fluid entry

With analogue output. Sizes in bar



XMLG●●●D●●●



XMLG●●●Q●●●

0 to 16 bar (0 to 232 psi)

Maximum permissible accidental pressure: 35.2 bar, destruction pressure: 40 bar

Analogue output type	Electrical connection	Reference (1)	Weight kg
G 1/4 A (male) fluid connection			
4...20 mA	M12	XMLG016D21 (2)	0.095
0...10 V	M12	XMLG016D71	0.095
1/4" - 18 NPT (male) fluid connection			
4...20 mA	M12	XMLG016D23	0.095
0...10 V	M12	XMLG010D73TQ (3)	0.095

0 to 25 bar (0 to 362.5 psi)

Maximum permissible accidental pressure: 56 bar, destruction pressure: 62.5 bar

Analogue output type	Electrical connection	Reference (1)	Weight kg
G 1/4 A (male) fluid connection			
4...20 mA	M12	XMLG025D21 (2)	0.095
	Integrated connection (4)	XMLG025Q21TQ (3)	0.095
0...10 V	M12	XMLG025D71 (2)	0.095
1/4" - 18 NPT (male) fluid connection			
4...20 mA	M12	XMLG025D23 (2)	0.095
0...10 V	M12	XMLG025D73TQ (3)	0.095

0 to 100 bar (0 to 1450 psi)

Maximum permissible accidental pressure: 225 bar, destruction pressure: 250 bar

Analogue output type	Electrical connection	Reference (1)	Weight kg
G 1/4 A (male) fluid connection			
4...20 mA	M12	XMLG100D21	0.095
	Integrated connection (4)	XMLG100Q21TQ (3)	0.095
0...10 V	M12	XMLG100D71 (2)	0.095
1/4" - 18 NPT (male) fluid connection			
4...20 mA	M12	XMLG100D23 (2)	0.095
0...10 V	M12	XMLG100D73TQ (3)	0.095

0 to 250 bar (0 to 3625 psi)

Maximum permissible accidental pressure: 560 bar, destruction pressure: 625 bar

Analogue output type	Electrical connection	Reference (1)	Weight kg
G 1/4 A (male) fluid connection			
4...20 mA	M12	XMLG250D21 (2)	0.095
0...10 V	M12	XMLG250D71 (2)	0.095
1/4" - 18 NPT (male) fluid connection			
4...20 mA	M12	XMLG250D23	0.095
0...10 V	M12	XMLG250D73TQ (3)	0.095

0 to 400 bar (0 to 5800 psi)

Maximum permissible accidental pressure: 800 bar, destruction pressure: 900 bar

Analogue output type	Electrical connection	Reference (1)	Weight kg
G 1/4 A (male) fluid connection			
4...20 mA	M12	XMLG400D21 (2)	0.095
0...10 V	M12	XMLG400D71 (2)	0.095
1/4" - 18 NPT (male) fluid connection			
4...20 mA	M12	XMLG400D23	0.095
0...10 V	M12	XMLG400D73TQ (3)	0.095

(1) For other electrical or fluid connections, or types of output, please consult our Customer Care Centre.

(2) Sold in lots of 25. Minimum quantity 50. Add TQ to the end of the reference selected. Example: XMLG016D21 becomes XMLG016D21TQ.

(3) Sold only in lots of 25. Minimum quantity 50.

(4) Phoenix Contact "Quickon" type integrated quick connection.

Electronic pressure sensors

OsiSense XM

XMLG pressure transmitters

Accessories and replacement parts

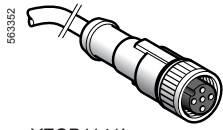

563352

XZCP1141L●

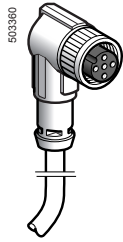

503360

XZCP1241L●

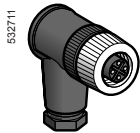

532711

XZCC12FCM40B

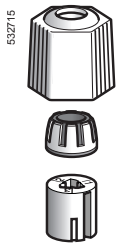

532715

XMLGZ001

Connection accessories

Description		Length of cable m	Reference	Weight kg
M12 female connector, metal clamping ring (1)	Straight	–	XZCC12FDM40B	0.020
	Elbowed	–	XZCC12FCM40B	0.020
Pre-wired M12 female connectors	Straight	2	XZCP1141L2	0.090
		5	XZCP1141L5	0.190
		10	XZCP1141L10	0.370
	Elbowed	2	XZCP1241L2	0.090
		5	XZCP1241L5	0.190
		10	XZCP1241L10	0.370

Replacement part

Description	Sold in lots of	Unit reference	Weight kg
Quick connection (2)	10	XMLGZ001	0.025

(1) Connector with screw terminal connections.

(2) Phoenix Contact "Quickon" type connection.

Electronic pressure sensors

OsiSense XM

XMLP pressure transmitters

Compact metal body, stainless steel fluid entry

With analogue output

Presentation

XMLP pressure transmitters rated at less than 9 bar or 100 psi

These transmitters integrate a ceramic pressure measuring cell. Ceramic technology has been used successfully for many years and offers a high level of sensitivity that is particularly suitable for measuring low pressures.

Ceramic also provides good resistance to abrasive fluids. An internal fluorocarbon rubber gasket provides the seal between the ceramic measuring cell and the AISI 316L stainless steel casing.

Pressure transmitters can be used to measure the following types of pressure:

- air
- fresh water
- the majority of hydraulic oils

It is important, however, to ensure that the gasket is compatible with the fluid being controlled.

These transmitters can control fluids ranging in temperature from -15 to 125 °C.

Their power supply (1) depends on the type of analogue output:

- 5 V +/- 10% for the 0.5...4.5 V ratiometric output
- 12 or 24 V (nominal), operating from 7 to 33 V for the 4...20 mA output
- 24 V (nominal), operating from 12 to 33 V for the 0...10 V output

XMLP pressure transmitters rated greater than or equal to 9 bar or 100 psi

These transmitters integrate a metal pressure measuring cell. This measuring cell, which is welded directly onto the AISI 316L stainless steel transmitter body, offers the following advantages:

- An all-metal pressure chamber, with no elastomer gasket in contact with the fluid
- Compatibility with a large number of fluids:
 - air
 - fresh water
 - hydraulic oils
 - refrigeration fluids
 - all fluids or gases compatible with AISI 316L stainless steel

XMLP pressure transmitters can control fluids ranging in temperature from -30 to 120 °C.

Their power supply (1) depends on the type of analogue output:

- 5 V +/- 10% for the 0.5...4.5 V ratiometric output
- 12 or 24 V (nominal), operating from 7 to 33 V for the 4...20 mA output
- 24 V (nominal), operating from 12 to 33 V for the 0...10 V output

General characteristics

Made of stainless steel, XMLP pressure transmitters are compact and rugged.

Their degree of protection varies according to the type of connector:

- IP 65 for EN 175301-803-A connector versions
- IP 65 and IP 67 for Packard Metri-Pack connector versions
- IP 65, IP 67 and IP 69K for M12 connector versions

With typical precision better than 0.5% of the rating, these transmitters are particularly suitable for industrial applications such as:

- machine tools
- moulding presses
- stamping presses
- lifting gear
- HVAC systems (for ratings greater than or equal to 9 bar or 100 psi only)

(1) Use Safety Extra Low Voltage (SELV) or Protected Extra Low Voltage (PELV) power supply.



XMLP pressure transmitters
AISI 316L stainless steel casing

Electronic pressure sensors

OsiSense XM

XMLP pressure transmitters

Compact metal body, stainless steel fluid entry

With analogue output.

Functions

XMLP pressure transmitters have an analogue output which delivers a signal proportional to the measured pressure.

This output can be one of the following types:

- 4...20 mA
- 0...10 V
- 0.5...4.5 V ratiometric

The pressure ranges available are:

- vacuum measuring
 - -1...0 bar
 - -14.5...0 psi
- pressure measuring
 - 0...600 bar
 - 0...6,000 psi
- combined pressure measuring (vacuum and pressure)
 - -1...25 bar
 - -14.5...60 psi

The XMLP offer is available with four types of electrical connection:

- M12, 4-pin connector
- EN 175301-803-A (ex DIN 43650) connector
- Packard Metri-Pack 150 connector
- 2 m PVC cable

Several types of fluid connection are available:

- G1/4 A male
- 1/4"-18NPT male
- SAE 7/16-20UNF-2A male
- SAE 7/16-20UNF-2B female (with or without Schrader pin depending on the model)

Depending on the model, XMLP transmitters are sold:

- individually
- in lots of 25

Electronic pressure sensors

OsiSense XM

XMLP pressure transmitters

Compact metal body, 316L stainless steel fluid entry

With analogue output. Sizes in bar



XMLP●●●GD●1F



XMLP●●●GC●1F



XMLP●●●GL●1F

-1 to 0 bar (-14.5 to 0 psi)

Maximum permissible accidental pressure: 3 bar, destruction pressure: 5 bar

Analogue output type	Electrical connection	Reference	Weight kg
G 1/4 A DIN 3852-E (male) fluid connection			
4...20 mA	M12	XMLPM00GD21F (1)	0.080
	EN 175301-803-A	XMLPM00GC21F (1)	0.096
	2 m cable	XMLPM00GL21F	0.197
0...10 V	M12	XMLPM00GD71F (1)	0.080
	EN 175301-803-A	XMLPM00GC71F (1)	0.096
	2 m cable	XMLPM00GL71F	0.197
0.5...4.5 V ratiometric	M12	XMLPM00GD11F	0.080
	EN 175301-803-A	XMLPM00GC11F	0.096

SAE 7/16-20UNF-2B (female) fluid connection

4...20 mA	M12	XMLPM00GD2BF	0.080
	EN 175301-803-A	XMLPM00GC2BF	0.096
0...10 V	M12	XMLPM00GD7BF	0.080
	EN 175301-803-A	XMLPM00GC7BF	0.096

-1 to 1 bar (-14.5 to 14.5 psi)

Maximum permissible accidental pressure: 3 bar, destruction pressure: 5 bar

Analogue output type	Electrical connection	Reference	Weight kg
G 1/4 A DIN 3852-E (male) fluid connection			
4...20 mA	M12	XMLPM01GD21F (1)	0.080
	EN 175301-803-A	XMLPM01GC21F (1)	0.096
0...10 V	M12	XMLPM01GD71F	0.080
	EN 175301-803-A	XMLPM01GC71F	0.096

-1 to 5 bar (-14.5 to 72.6 psi)

Maximum permissible accidental pressure: 18 bar, destruction pressure: 24 bar

Analogue output type	Electrical connection	Reference	Weight kg
G 1/4 A DIN 3852-E (male) fluid connection			
4...20 mA	M12	XMLPM05GD21F (1)	0.080
	EN 175301-803-A	XMLPM05GC21F (1)	0.096
0...10 V	M12	XMLPM05GD71F	0.080
	EN 175301-803-A	XMLPM05GC71F	0.096

(1) Sold in lots of 25: add the letter Q to the end of the selected reference. For example, XMLPM00GD21F becomes XMLPM00GD21FQ.

Electronic pressure sensors

OsiSense XM

XMLP pressure transmitters

Compact metal body, 316L stainless steel fluid entry

With analogue output. Sizes in bar

PF151601



XMLP●●BD●1F

- 1 to 9 bar (- 14.5 to 130 psi)

Maximum permissible accidental pressure: 30 bar, destruction pressure: 60 bar

Analogue output type	Electrical connection	Reference	Weight kg
G 1/4 A DIN 3852-E (male) fluid connection			
4...20 mA	M12	XMLPM09BD21F (1)	0.090
	EN 175301-803-A	XMLPM09BC21F	0.106
0...10 V	M12	XMLPM09BD71F (1)	0.090
	EN 175301-803-A	XMLPM09BC71F	0.106

XM-EX_522_CPMFS17001



XMLP●●BC●1F

- 1 to 25 bar (- 14.5 to 362.5 psi)

Maximum permissible accidental pressure: 75 bar, destruction pressure: 150 bar

Analogue output type	Electrical connection	Reference	Weight kg
G 1/4 A DIN 3852-E (male) fluid connection			
4...20 mA	M12	XMLPM25BD21F	0.090

(1) Sold in lots of 25: add the letter Q to the end of the selected reference.
For example, **XMLPM09BD21F** becomes **XMLPM09BD21FQ**.

Electronic pressure sensors

OsiSense XM

XMLP pressure transmitters

Compact metal body, 316L stainless steel fluid entry

With analogue output. Sizes in bar



XMLP●●●●D●1F



XMLP●●●●C●1F



XMLP001GL●1F



XMLP001GC●BF



XMLP001GD●BF

0 to 0.25 bar (0 to 3.63 psi)

Maximum permissible accidental pressure: 3 bar, destruction pressure: 5 bar

Analogue output type	Electrical connection	Reference	Weight kg
G 1/4 A DIN 3852-E (male) fluid connection			
4...20 mA	M12	XMLP250MD21F (1)	0.080
	EN 175301-803-A	XMLP250MC21F (1)	0.096
0...10 V	M12	XMLP250MD71F (1)	0.080
	EN 175301-803-A	XMLP250MC71F (1)	0.096
0.5...4.5 V ratiometric	M12	XMLP250MD11F	0.080
	EN 175301-803-A	XMLP250MC11F	0.096

0 to 0.5 bar (0 to 7.26 psi)

Maximum permissible accidental pressure: 3 bar, destruction pressure: 5 bar

Analogue output type	Electrical connection	Reference	Weight kg
G 1/4 A DIN 3852-E (male) fluid connection			
4...20 mA	M12	XMLP500MD21F (1)	0.080
	EN 175301-803-A	XMLP500MC21F (1)	0.096
0...10 V	M12	XMLP500MD71F (1)	0.080
	EN 175301-803-A	XMLP500MC71F (1)	0.096
0.5...4.5 V ratiometric	M12	XMLP500MD11F	0.080
	EN 175301-803-A	XMLP500MC11F	0.096

0 to 1 bar (0 to 14.5 psi)

Maximum permissible accidental pressure: 3 bar, destruction pressure: 5 bar

Analogue output type	Electrical connection	Reference	Weight kg
G 1/4 A DIN 3852-E (male) fluid connection			
4...20 mA	M12	XMLP001GD21F (1)	0.080
	EN 175301-803-A	XMLP001GC21F (1)	0.096
	2 m cable	XMLP001GL21F	0.197
0...10 V	M12	XMLP001GD71F (1)	0.080
	EN 175301-803-A	XMLP001GC71F (1)	0.096
	2 m cable	XMLP001GL71F	0.197
0.5...4.5 V ratiometric	M12	XMLP001GD11F (1)	0.080
	EN 175301-803-A	XMLP001GC11F	0.096

SAE 7/16-20UNF-2B (female) fluid connection

4...20 mA	M12	XMLP001GD2BF	0.080
	EN 175301-803-A	XMLP001GC2BF	0.096
0...10 V	M12	XMLP001GD7BF	0.080
	EN 175301-803-A	XMLP001GC7BF	0.096

(1) Sold in lots of 25: add the letter Q to the end of the selected reference. For example, XMLP250MD21F becomes XMLP250MD21FQ.

Electronic pressure sensors

OsiSense XM

XMLP pressure transmitters

Compact metal body, 316L stainless steel fluid entry
With analogue output. Sizes in bar



XMLP●●●●D●1F



XMLP●●●●C●1F



XMLP●●●●GL●1F

0 to 2.5 bar (0 to 36.3 psi)

Maximum permissible accidental pressure: 7.5 bar, destruction pressure: 10 bar

Analogue output type	Electrical connection	Reference	Weight kg
G 1/4 A DIN 3852-E (male) fluid connection			
4...20 mA	M12	XMLP2D5GD21F (1)	0.080
	EN 175301-803-A	XMLP2D5GC21F (1)	0.096
	2 m cable	XMLP2D5GL21F	0.197
0...10 V	M12	XMLP2D5GD71F (1)	0.080
	EN 175301-803-A	XMLP2D5GC71F (1)	0.096
	2 m cable	XMLP2D5GL71F	0.197
0.5...4.5 V ratiometric	M12	XMLP2D5GD11F	0.080
	EN 175301-803-A	XMLP2D5GC11F	0.096

0 to 4 bar (0 to 58 psi)

Maximum permissible accidental pressure: 12 bar, destruction pressure: 16 bar

Analogue output type	Electrical connection	Reference	Weight kg
G 1/4 A DIN 3852-E (male) fluid connection			
4...20 mA	M12	XMLP004GD21F (1)	0.080
	EN 175301-803-A	XMLP004GC21F (1)	0.096
0...10 V	M12	XMLP004GD71F (1)	0.080
	EN 175301-803-A	XMLP004GC71F (1)	0.096
0.5...4.5 V ratiometric	M12	XMLP004GD11F	0.080
	EN 175301-803-A	XMLP004GC11F	0.096

0 to 6 bar (0 to 87 psi)

Maximum permissible accidental pressure: 18 bar, destruction pressure: 24 bar

Analogue output type	Electrical connection	Reference	Weight kg
G 1/4 A DIN 3852-E (male) fluid connection			
4...20 mA	M12	XMLP006GD21F (1)	0.080
	EN 175301-803-A	XMLP006GC21F (1)	0.096
	2 m cable	XMLP006GL21F	0.197
0...10 V	M12	XMLP006GD71F (1)	0.080
	EN 175301-803-A	XMLP006GC71F (1)	0.096
	2 m cable	XMLP006GL71F	0.197
0.5...4.5 V ratiometric	M12	XMLP006GD11F (1)	0.080
	EN 175301-803-A	XMLP006GC11F	0.096

(1) Sold in lots of 25; add the letter Q to the end of the selected reference.
For example, XMLP004GD71F becomes XMLP004GD71FQ.

Electronic pressure sensors

OsiSense XM

XMLP pressure transmitters

Compact metal body, 316L stainless steel fluid entry

With analogue output. Sizes in bar



XMLP01●BC●1F



XMLP01●BD●1F



XMLP01●BC270



XMLP01●BD270



XMLP01●BC●90



XMLP01●BD●90

0 to 10 bar (0 to 145 psi)

Maximum permissible accidental pressure: 30 bar, destruction pressure: 60 bar

Analogue output type	Electrical connection	Reference	Weight kg
G 1/4 A DIN 3852-E (male) fluid connection			
4...20 mA	M12	XMLP010BD21F (1)	0.090
	EN 175301-803-A	XMLP010BC21F (1)	0.106
0...10 V	M12	XMLP010BD71F (1)	0.090
	EN 175301-803-A	XMLP010BC71F (1)	0.106
0.5...4.5 V ratiometric	M12	XMLP010BD11F	0.090
	EN 175301-803-A	XMLP010BC11F	0.106

SAE 7/16-20UNF-2A (male) fluid connection

4...20 mA	M12	XMLP010BD270	0.087
	EN 175301-803-A	XMLP010BC270	0.103

SAE 7/16-20UNF-2B (female with Schrader pin) fluid connection

4...20 mA	M12	XMLP010BD290 (1)	0.100
	EN 175301-803-A	XMLP010BC290	0.116
0...10 V	M12	XMLP010BD790	0.100
	EN 175301-803-A	XMLP010BC790	0.116
0.5...4.5 V ratiometric	M12	XMLP010BD190	0.100

0 to 16 bar (0 to 232 psi)

Maximum permissible accidental pressure: 48 bar, destruction pressure: 96 bar

Analogue output type	Electrical connection	Reference	Weight kg
G 1/4 A DIN 3852-E (male) fluid connection			
4...20 mA	M12	XMLP016BD21F (1)	0.090
	EN 175301-803-A	XMLP016BC21F (1)	0.106
0...10 V	M12	XMLP016BD71F (1)	0.090
	EN 175301-803-A	XMLP016BC71F (1)	0.106
0.5...4.5 V ratiometric	M12	XMLP016BD11F	0.090
	EN 175301-803-A	XMLP016BC11F	0.106

SAE 7/16-20UNF-2A (male) fluid connection

4...20 mA	M12	XMLP016BD270	0.087
	EN 175301-803-A	XMLP016BC270	0.103

SAE 7/16-20UNF-2B (female with Schrader pin) fluid connection

4...20 mA	M12	XMLP016BD290	0.100
	EN 175301-803-A	XMLP016BC290	0.116
0...10 V	M12	XMLP016BD790	0.100
0.5...4.5 V ratiometric	M12	XMLP016BD190	0.100

(1) Sold in lots of 25; add the letter Q to the end of the selected reference. For example, XMLP016BD21F becomes XMLP016BD21FQ.

Electronic pressure sensors

OsiSense XM

XMLP pressure transmitters

Compact metal body, 316L stainless steel fluid entry

With analogue output. Sizes in bar



XMLP0...BC...1F



XMLP0...BD...1F



XMLP0...BC270



XMLP0...BD270



XMLP0...BC...90



XMLP0...BD...90

0 to 25 bar (0 to 362.5 psi)

Maximum permissible accidental pressure: 75 bar, destruction pressure: 150 bar

Analogue output type	Electrical connection	Reference	Weight kg
G 1/4 A DIN 3852-E (male) fluid connection			
4...20 mA	M12	XMLP025BD21F	0.090
	EN 175301-803-A	XMLP025BC21F	0.106
0...10 V	M12	XMLP025BD71F (1)	0.090
	EN 175301-803-A	XMLP025BC71F	0.106
0.5...4.5 V ratiometric	M12	XMLP025BD11F	0.090
	EN 175301-803-A	XMLP025BC11F	0.106

SAE 7/16-20UNF-2A (male) fluid connection

4...20 mA	M12	XMLP025BD270	0.087
	EN 175301-803-A	XMLP025BC270	0.103
0...10 V	M12	XMLP025BD770	0.087

SAE 7/16-20UNF-2B (female with Schrader pin) fluid connection

4...20 mA	M12	XMLP025BD290	0.100
	EN 175301-803-A	XMLP025BC290	0.116
0...10 V	M12	XMLP025BD790	0.100

0 to 40 bar (0 to 580 psi)

Maximum permissible accidental pressure: 120 bar, destruction pressure: 240 bar

Analogue output type	Electrical connection	Reference	Weight kg
G 1/4 A DIN 3852-E (male) fluid connection			
4...20 mA	M12	XMLP040BD21F (1)	0.090
	EN 175301-803-A	XMLP040BC21F	0.106
0...10 V	M12	XMLP040BD71F	0.090
	EN 175301-803-A	XMLP040BC71F	0.106
0.5...4.5 V ratiometric	M12	XMLP040BD11F	0.090
	EN 175301-803-A	XMLP040BC11F	0.106

SAE 7/16-20UNF-2A (male) fluid connection

4...20 mA	M12	XMLP040BD270	0.087
	EN 175301-803-A	XMLP040BC270	0.103

SAE 7/16-20UNF-2B (female with Schrader pin) fluid connection

4...20 mA	M12	XMLP040BD290 (1)	0.100
	EN 175301-803-A	XMLP040BC290 (1)	0.116
0...10 V	M12	XMLP040BD790	0.100
0.5...4.5 V ratiometric	M12	XMLP040BD190	0.100

(1) Sold in lots of 25; add the letter Q to the end of the selected reference. For example, XMLP040BD21F becomes XMLP040BD21FQ.

Electronic pressure sensors

OsiSense XM

XMLP pressure transmitters

Compact metal body, 316L stainless steel fluid entry

With analogue output. Sizes in bar



XMLP●●●BC●1F



XMLP●●●BD●1F



XMLP060BD270



XMLP060BC290



XMLP060BD●90

0 to 60 bar (0 to 870 psi)

Maximum permissible accidental pressure: 180 bar, destruction pressure: 360 bar

Analogue output type	Electrical connection	Reference	Weight kg
G 1/4 A DIN 3852-A (male) fluid connection			
4...20 mA	M12	XMLP060BD21F (1)	0.090
	EN 175301-803-A	XMLP060BC21F	0.106
0...10 V	M12	XMLP060BD71F (1)	0.090
	EN 175301-803-A	XMLP060BC71F (1)	0.106
0.5...4.5 V ratiometric	M12	XMLP060BD11F	0.090
	EN 175301-803-A	XMLP060BC11F	0.106

SAE 7/16-20UNF-2A (male) fluid connection

4...20 mA	M12	XMLP060BD270	0.087
-----------	-----	--------------	-------

SAE 7/16-20UNF-2B (female with Schrader pin) fluid connection

4...20 mA	M12	XMLP060BD290	0.100
	EN 175301-803-A	XMLP060BC290	0.116
0...10 V	M12	XMLP060BD790	0.100

0 to 100 bar (0 to 1450 psi)

Maximum permissible accidental pressure: 300 bar, destruction pressure: 600 bar

Analogue output type	Electrical connection	Reference	Weight kg
G 1/4 A DIN 3852-A (male) fluid connection			
4...20 mA	M12	XMLP100BD21F (1)	0.094
	EN 175301-803-A	XMLP100BC21F	0.110
0...10 V	M12	XMLP100BD71F (1)	0.094
	EN 175301-803-A	XMLP100BC71F	0.110
0.5...4.5 V ratiometric	M12	XMLP100BD11F	0.094
	EN 175301-803-A	XMLP100BC11F	0.110

(1) Sold in lots of 25: add the letter Q to the end of the selected reference. For example, XMLP060BD21F becomes XMLP060BD21FQ.

Electronic pressure sensors

OsiSense XM

XMLP pressure transmitters

Compact metal body, 316L stainless steel fluid entry

With analogue output. Sizes in bar

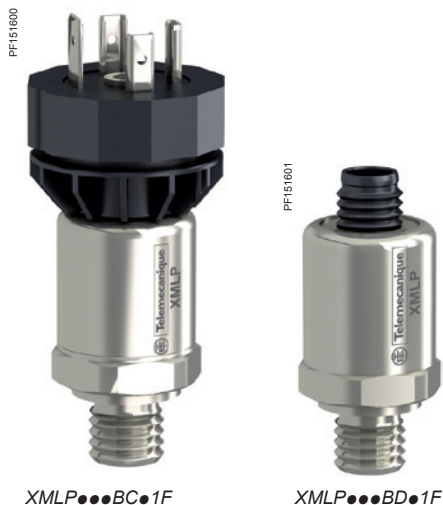

XMLP●●●BC●1F

XMLP●●●BD●1F

0 to 160 bar (0 to 2320 psi)

Maximum permissible accidental pressure: 480 bar, destruction pressure: 960 bar

Analogue output type	Electrical connection	Reference	Weight kg
G 1/4 A DIN 3852-A (male) fluid connection			
4...20 mA	M12	XMLP160BD21F	0.094
	EN 175301-803-A	XMLP160BC21F	0.110
0...10 V	M12	XMLP160BD71F	0.094
	EN 175301-803-A	XMLP160BC71F	0.110
0.5...4.5 V ratiometric	M12	XMLP160BD11F	0.094

0 to 250 bar (0 to 3625 psi)

Maximum permissible accidental pressure: 750 bar, destruction pressure: 1500 bar

Analogue output type	Electrical connection	Reference	Weight kg
G 1/4 A DIN 3852-A (male) fluid connection			
4...20 mA	M12	XMLP250BD21F (1)	0.094
	EN 175301-803-A	XMLP250BC21F	0.110
0...10 V	M12	XMLP250BD71F (1)	0.094
	EN 175301-803-A	XMLP250BC71F (1)	0.110
0.5...4.5 V ratiometric	M12	XMLP250BD11F	0.094
	EN 175301-803-A	XMLP250BC11F	0.110

0 to 400 bar (0 to 5800 psi)

Maximum permissible accidental pressure: 1200 bar, destruction pressure: 2400 bar

Analogue output type	Electrical connection	Reference	Weight kg
G 1/4 A DIN 3852-A (male) fluid connection			
4...20 mA	M12	XMLP400BD21F (1)	0.094
	EN 175301-803-A	XMLP400BC21F (1)	0.110
0...10 V	M12	XMLP400BD71F	0.094
	EN 175301-803-A	XMLP400BC71F (1)	0.110
0.5...4.5 V ratiometric	M12	XMLP400BD11F	0.094
	EN 175301-803-A	XMLP400BC11F	0.110

0 to 600 bar (0 to 8700 psi)

Maximum permissible accidental pressure: 1500 bar, destruction pressure: 2400 bar

Analogue output type	Electrical connection	Reference	Weight kg
G 1/4 A DIN 3852-A (male) fluid connection			
4...20 mA	M12	XMLP600BD21F	0.094
	EN 175301-803-A	XMLP600BC21F	0.110
0...10 V	M12	XMLP600BD71F	0.094
	EN 175301-803-A	XMLP600BC71F	0.110
0.5...4.5 V ratiometric	M12	XMLP600BD11F	0.094

(1) Sold in lots of 25: add the letter Q to the end of the selected reference.
For example, XMLP250BD21F becomes XMLP250BD21FQ.

Electronic pressure sensors

OsiSense XM

XMLP pressure transmitters

Compact metal body, 316L stainless steel fluid entry

With analogue output. Sizes in psi



XMLP●●●RD●3F



XMLP●●●RC●3F



XMLP●●●RP●3F

-14.5 to 0 psi (-1 to 0 bar)

Maximum permissible accidental pressure: 44 psi, destruction pressure: 73 psi

Analogue output type	Electrical connection	Reference	Weight kg
1/4" - 18NPT (male) fluid connection			
4...20 mA	M12	XMLPM00RD23F (1)	0.078
	EN 175301-803-A	XMLPM00RC23F	0.094
	Packard Metri-Pack 150	XMLPM00RP23F	0.080
0...10 V	M12	XMLPM00RD73F (1)	0.078
	EN 175301-803-A	XMLPM00RC73F	0.094
	Packard Metri-Pack 150	XMLPM00RP73F	0.080
0.5...4.5 V ratiometric	M12	XMLPM00RD13F	0.078
	EN 175301-803-A	XMLPM00RC13F	0.094
	Packard Metri-Pack 150	XMLPM00RP13F	0.080

-14.5 to 15 psi (-1 to 1.03 bar)

Maximum permissible accidental pressure: 44 psi, destruction pressure: 73 psi

Analogue output type	Electrical connection	Reference	Weight kg
1/4" - 18NPT (male) fluid connection			
4...20 mA	M12	XMLPM15RD23F (1)	0.078
	EN 175301-803-A	XMLPM15RC23F	0.094
	Packard Metri-Pack 150	XMLPM15RP23F (1)	0.080
0...10 V	M12	XMLPM15RD73F (1)	0.078

-14.5 to 60 psi (-1 to 4.14 bar)

Maximum permissible accidental pressure: 260 psi, destruction pressure: 350 psi

Analogue output type	Electrical connection	Reference	Weight kg
1/4" - 18NPT (male) fluid connection			
4...20 mA	M12	XMLPM60RD23F (1)	0.078
	EN 175301-803-A	XMLPM60RC23F	0.094
	Packard Metri-Pack 150	XMLPM60RP23F	0.080
0...10 V	M12	XMLPM60RD73F (1)	0.078

(1) Sold in lots of 25: add the letter Q to the end of the selected reference. For example, XMLPM00RD23F becomes XMLPM00RD23FQ.

Electronic pressure sensors

OsiSense XM

XMLP pressure transmitters

Compact metal body, 316L stainless steel fluid entry

With analogue output. Sizes in psi

PF151605



XMLP000RD03F

PF151606



XMLP000RC03F

PF151607



XMLP000RP03F

0 to 15 psi (0 to 1.03 bar)

Maximum permissible accidental pressure: 44 psi, destruction pressure: 73 psi

Analogue output type	Electrical connection	Reference	Weight kg
1/4" - 18NPT (male) fluid connection			
4...20 mA	M12	XMLP015RD23F (1)	0.078
	EN 175301-803-A	XMLP015RC23F	0.094
	Packard Metri-Pack 150	XMLP015RP23F	0.080
0...10 V	M12	XMLP015RD73F (1)	0.078
	EN 175301-803-A	XMLP015RC73F	0.094
	Packard Metri-Pack 150	XMLP015RP73F	0.080

0 to 30 psi (0 to 2.07 bar)

Maximum permissible accidental pressure: 109 psi, destruction pressure: 145 psi

Analogue output type	Electrical connection	Reference	Weight kg
1/4" - 18NPT (male) fluid connection			
4...20 mA	M12	XMLP030RD23F (1)	0.078
	EN 175301-803-A	XMLP030RC23F	0.094
	Packard Metri-Pack 150	XMLP030RP23F	0.080
0...10 V	M12	XMLP030RD73F (1)	0.078
	EN 175301-803-A	XMLP030RC73F	0.094
	Packard Metri-Pack 150	XMLP030RP73F	0.080

0 to 50 psi (0 to 3.45 bar)

Maximum permissible accidental pressure: 174 psi, destruction pressure: 232 psi

Analogue output type	Electrical connection	Reference	Weight kg
1/4" - 18NPT (male) fluid connection			
4...20 mA	M12	XMLP050RD23F (1)	0.078
	EN 175301-803-A	XMLP050RC23F	0.094
	Packard Metri-Pack 150	XMLP050RP23F	0.080
0...10 V	M12	XMLP050RD73F (1)	0.078

0 to 100 psi (0 to 6.9 bar)

Maximum permissible accidental pressure: 260 psi, destruction pressure: 340 psi

Analogue output type	Electrical connection	Reference	Weight kg
1/4" - 18NPT (male) fluid connection			
4...20 mA	M12	XMLP100RD23F	0.078
0...10 V	M12	XMLP100RD73F	0.078

(1) Sold in lots of 25: add the letter Q to the end of the selected reference.
For example, XMLP030RD73F becomes XMLP030RD73FQ.

Electronic pressure sensors

OsiSense XM

XMLP pressure transmitters

Compact metal body, 316L stainless steel fluid entry

With analogue output. Sizes in psi

PF151605



XMLP●●0PD●30

PF151607



XMLP●●0PP●30

0 to 100 psi (0 to 6.9 bar)

Maximum permissible accidental pressure: 300 psi, destruction pressure: 900 psi

Analogue output type	Electrical connection	Reference	Weight kg
1/4" - 18NPT (male) fluid connection			
4...20 mA	M12	XMLP100PD230 (1)	0.088
	Packard Metri-Pack 150	XMLP100PP230 (1)	0.090
0...10 V	M12	XMLP100PD730	0.088
	Packard Metri-Pack 150	XMLP100PP730	0.090
0.5...4.5 V ratiometric	M12	XMLP100PD130	0.088
	Packard Metri-Pack 150	XMLP100PP130	0.090

0 to 150 psi (0 to 10.3 bar)

Maximum permissible accidental pressure: 450 psi, destruction pressure: 900 psi

Analogue output type	Electrical connection	Reference	Weight kg
1/4" - 18NPT (male) fluid connection			
4...20 mA	M12	XMLP150PD230 (1)	0.088
	Packard Metri-Pack 150	XMLP150PP230	0.090
0...10 V	M12	XMLP150PD730	0.088
	Packard Metri-Pack 150	XMLP150PP730	0.090
0.5...4.5 V ratiometric	M12	XMLP150PD130	0.088

0 to 200 psi (0 to 13.8 bar)

Maximum permissible accidental pressure: 600 psi, destruction pressure: 1400 psi

Analogue output type	Electrical connection	Reference	Weight kg
1/4" - 18NPT (male) fluid connection			
4...20 mA	M12	XMLP200PD230 (1)	0.088
	Packard Metri-Pack 150	XMLP200PP230	0.090
0...10 V	M12	XMLP200PD730	0.088
	Packard Metri-Pack 150	XMLP200PP730	0.090
0.5...4.5 V ratiometric	M12	XMLP200PD130	0.088

(1) Sold in lots of 25; add the letter Q to the end of the selected reference.
For example, XMLP100PD230 becomes XMLP100PD230Q.

Electronic pressure sensors

OsiSense XM

XMLP pressure transmitters

Compact metal body, 316L stainless steel fluid entry
With analogue output. Sizes in psi

PF151605



XMLP●●0PD●30

PF151607



XMLP●●0PP●30

0 to 300 psi (0 to 20.7 bar)

Maximum permissible accidental pressure: 900 psi, destruction pressure: 2200 psi

Analogue output type	Electrical connection	Reference	Weight kg
1/4" - 18NPT (male) fluid connection			
4...20 mA	M12	XMLP300PD230 (1)	0.088
	Packard Metri-Pack 150	XMLP300PP230	0.090
0...10 V	M12	XMLP300PD730	0.088
	Packard Metri-Pack 150	XMLP300PP730	0.090
0.5...4.5 V ratiometric	M12	XMLP300PD130	0.088
	Packard Metri-Pack 150	XMLP300PP130	0.090

0 to 600 psi (0 to 41.4 bar)

Maximum permissible accidental pressure: 1800 psi, destruction pressure: 3600 psi

Analogue output type	Electrical connection	Reference	Weight kg
1/4" - 18NPT (male) fluid connection			
4...20 mA	M12	XMLP600PD230	0.088
	Packard Metri-Pack 150	XMLP600PP230 (1)	0.090
0...10 V	M12	XMLP600PD730	0.088
	Packard Metri-Pack 150	XMLP600PP730	0.090
0.5...4.5 V ratiometric	M12	XMLP600PD130	0.088
	Packard Metri-Pack 150	XMLP600PP130	0.090

0 to 1000 psi (0 to 69 bar)

Maximum permissible accidental pressure: 3000 psi, destruction pressure: 6000 psi

Analogue output type	Electrical connection	Reference	Weight kg
1/4" - 18NPT (male) fluid connection			
4...20 mA	M12	XMLP1K0PD230	0.088
	Packard Metri-Pack 150	XMLP1K0PP230	0.090
0...10 V	M12	XMLP1K0PD730	0.088
	Packard Metri-Pack 150	XMLP1K0PP730	0.090
0.5...4.5 V ratiometric	M12	XMLP1K0PD130	0.088

(1) Sold in lots of 25: add the letter Q to the end of the selected reference.
For example, **XMLP600PP230** becomes **XMLP600PP230Q**.

Electronic pressure sensors

OsiSense XM

XMLP pressure transmitters

Compact metal body, 316L stainless steel fluid entry

With analogue output. Sizes in psi

PF151605



XMLP•K0PD•30

PF151607



XMLP•K0PP•30

0 to 2000 psi (0 to 138 bar)

Maximum permissible accidental pressure: 6000 psi, destruction pressure: 12 000 psi

Analogue output type	Electrical connection	Reference	Weight kg
1/4" - 18NPT (male) fluid connection			
4...20 mA	M12	XMLP2K0PD230	0.092
0...10 V	M12	XMLP2K0PD730	0.092
0.5...4.5 V ratiometric	M12	XMLP2K0PD130	0.092

0 to 3000 psi (0 to 207 bar)

Maximum permissible accidental pressure: 9000 psi, destruction pressure: 18 000 psi

Analogue output type	Electrical connection	Reference	Weight kg
1/4" - 18NPT (male) fluid connection			
4...20 mA	M12	XMLP3K0PD230	0.092
	Packard Metri-Pack 150	XMLP3K0PP230	0.094
0...10 V	M12	XMLP3K0PD730 (1)	0.092
	Packard Metri-Pack 150	XMLP3K0PP730	0.094
0.5...4.5 V ratiometric	M12	XMLP3K0PD130	0.092

0 to 6000 psi (0 to 414 bar)

Maximum permissible accidental pressure: 18 000 psi, destruction pressure: 36 000 psi

Analogue output type	Electrical connection	Reference	Weight kg
1/4" - 18NPT (male) fluid connection			
4...20 mA	M12	XMLP6K0PD230	0.092
	Packard Metri-Pack 150	XMLP6K0PP730	0.094
0...10 V	M12	XMLP6K0PD730	0.092
	Packard Metri-Pack 150	XMLP6K0PP130 (1)	0.094
0.5...4.5 V ratiometric	M12	XMLP6K0PD130	0.092
	Packard Metri-Pack 150	XMLP6K0PP130 (1)	0.094

(1) Sold in lots of 25: add the letter Q to the end of the selected reference. For example, XMLP6K0PP130 becomes XMLP6K0PP130Q.

Electronic pressure sensors

OsiSense XM
XMLP pressure transmitters
Separate parts



ZMLPA1●2SH

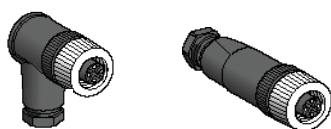

XZCC12FCM40B XZCC12FDM40B

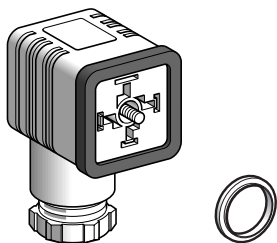

XZCC43FCP40B XMLZL016

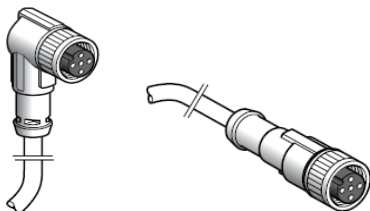

XZCP1241L5 XZCP1141L10

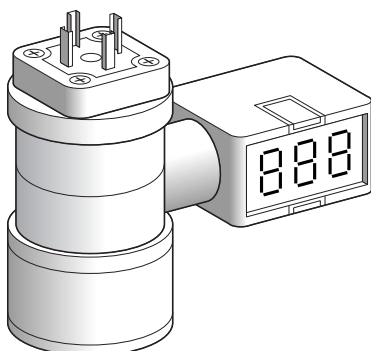

XMLEZ●●●

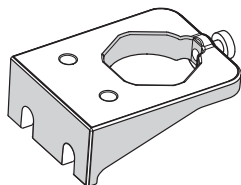

XMLZL017

Switches with display for XMLP●●●●D2●● pressure transmitters (1)

Analogue output type	Solid-state output type	Switching mode	Reference	Weight kg
4...20 mA	1 x PNP	Hysteresis	ZMLPA1P2SH	0.104
		Window	ZMLPA1P2SW	0.104
	1 x NPN	Hysteresis	ZMLPA1N2SH	0.104
		Window	ZMLPA1N2SW	0.104
–	2 x PNP	Hysteresis	ZMLPA2P0SH	0.104
–	2 x NPN	Hysteresis	ZMLPA2N0SH	0.104

Accessories

Description	Type	Reference	Weight kg
Sealing gasket (Pack of 10 gaskets)	–	XMLZL016	0.025
M12 female connector metal clamping ring (2)	Straight	XZCC12FDM40B	0.020
	Elbowed	XZCC12FCM40B	0.020
EN 175301-803-A female connector (2)	–	XZCC43FCP40B	0.035

Description	Cable length	Cable material	Reference	Weight kg
Pre-wired M12, straight, female connectors	2 m	PUR	XZCP1141L2	0.090
		PVC	XZCPV1141L2	0.110
	5 m	PUR	XZCP1141L5	0.190
		PVC	XZCPV1141L5	0.210
	10 m	PUR	XZCP1141L10	0.370
		PVC	XZCPV1141L10	0.390
Pre-wired M12, elbowed, female connectors	2 m	PUR	XZCP1241L2	0.090
		PVC	XZCPV1241L2	0.110
	5 m	PUR	XZCP1241L5	0.190
		PVC	XZCPV1241L5	0.210
	10 m	PUR	XZCP1241L10	0.370
		PVC	XZCPV1241L10	0.390

Description	For use with	Size of transmitter bar	Reference	Weight kg
Digital displays for pressure transmitters	XMLPM00GC2●●	- 1...0	XMLEZM01	0.100
	XMLP001GC2●●	0...1	XMLEZ001	0.100
	XMLP010BC2●●	0...10	XMLEZ010	0.100
	XMLP025BC2●●	0...25	XMLEZ025	0.100
	XMLP060BC2●●	0...60	XMLEZ060	0.100
	XMLP100BC2●●	0...100	XMLEZ100	0.100
	XMLP250BC2●●	0...250	XMLEZ250	0.100
	XMLP600BC2●●	0...600	XMLEZ600	0.100
Fixing bracket (aluminium)	XMLP●●●M●●● XMLP●●●G●●● XMLP●●●R●●●	–	XMLZL017	0.029

(1) ZMLP switches are compatible with pressure transmitters with 4...20 mA analogue output and M12 connector (see pages 44 and 45).

(2) Connector with screw terminal connections.

Note: For other connection accessories, visit our website www.tesensors.com.

Electronic pressure sensors

OsiSense XM

XMEP pressure transmitters for mobile equipments

OsiSense XMEP

OsiSense XMEP pressure transmitters are used to control and measure pressure levels in hydraulic systems in mobile equipments.

These sensors are particularly suitable for mobile cranes, forklift trucks, aerial platforms, construction machinery, agricultural and forestry machinery, fire trucks and garbage trucks, etc.

Mobile equipments are used in locations characterised by harsh environmental conditions, subject to pressure peaks and high vibration levels.

Telemecanique Sensors supplies an ideal solution for this type of equipment. OsiSense XMEP pressure transmitters offer dedicated electrical connections and temperature ranges, degrees of protection and levels of EMC immunity appropriate to these applications.

In addition, OsiSense XMEP transmitters are among the most compact on the market, which makes them easy to integrate into confined spaces in mobile equipments.

These pressure transmitters are available for pressure ranges from 0...60 bar to 0...600 bar (0...1000 psi to 0...7500 psi) and are equipped with the most commonly used fluid entries, G1/4 and 1/4"-18NPT male.

OsiSense XMEP transmitters have an analogue output which delivers a signal proportional to the measured pressure.

This output can be one of the following types:

- > 4...20 mA
- > 0...10 V
- > 0.5...4.5 V ratiometric

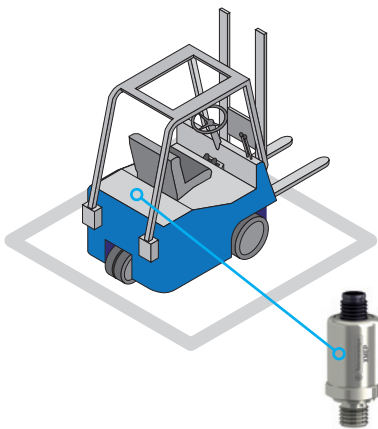
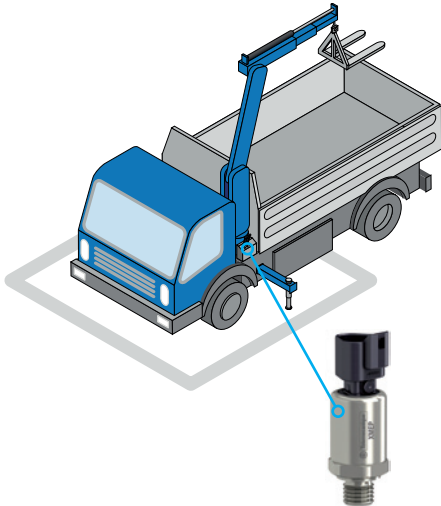

Specially designed for mobile equipments

- > Designed to be supplied by 12 or 24 volt battery or via ratiometric output controller.
- > Equipped with the most widely used connectors for this type of application: M12, Deutsch DT04-3P, AMP Superseal or AMP Junior Power Time. The connector is factory-mounted which helps to ensure greater contact reliability over time.
- > Reliable operation over a wide temperature range from - 40 °C to + 100 °C.
- > Designed to comply with the requirements of the following standards:
 - > EN 13309 (Construction machinery)
 - > ISO 13766 (Earth-moving machinery)
 - > ISO 14982 (Agricultural and forestry machinery)
 - > UNECE 10R-5 (Automotive industry)



+ Simple, effective pressure control in your mobile equipments

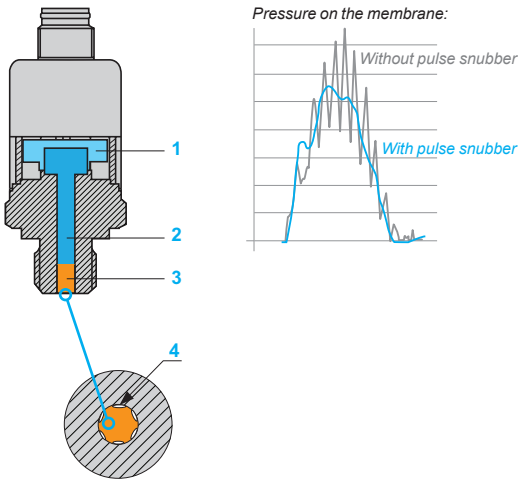

- 1: Metal membrane
- 2: Inlet pipe
- 3: Pulse snubber inserted inside the inlet pipe to protect the membrane from pressure surges
- 4: 6 slots to allow the fluid to pass through at a reduced flow rate

Rugged, compact and certified

Rugged

- > Excellent mechanical and corrosion resistance provided by the 316L stainless steel housing and glass fibre reinforced polyarylamide connector
- > High resistance to pressure surges (3 times nominal pressure)
- > Built-in pulse snubber to help protect against water hammer (pressure surges)
- > High immunity to electromagnetic interference, up to 100 V/m conforming to standard ISO 11452
- > High shock and vibration resistance
- > Protected against temporary immersion and high pressure cleaning processes (IP65, IP67 and IP69K)

Compact

- > 24 mm diameter and height ranging from 38 to 62 mm depending on the electrical connection



The OsiSense XMEP pressure sensor's compact dimensions mean it can be easily integrated into mobile equipments.

Certified

- > cULus conforming to UL 61010-1
- > E2 conforming to UNECE 10R-5
- > Compliant with environmental RoHs and REACH standards



Sold in lots

Depending on the model, XMEP transmitters are sold:

- > Individually
- > In lots of 25, for easy unpacking and less packaging waste



75%

less packaging
helping to preserve our environment
and make your life easier

Electronic pressure sensors

OsiSense XM

XMEP pressure transmitters for mobile equipments

With analogue output

Sizes in bar

XM-EX_522_CPSCT16005



XMEP00BD1F

XM-EX_522_CPSCT16004



XMEP00BT1F

XM-EX_522_CPSCT16002



XMEP00BV1F

XM-EX_522_CPSCT16001



XMEP250BJ1F

0 to 60 bar (0 to 870 psi)

Maximum permissible accidental pressure: 150 bar, destruction pressure: 300 bar

Analogue output type	Electrical connection	Reference	Weight kg
G 1/4 A DIN 3852-E (male) fluid connection			
4...20 mA	M12	XMEP060BD21F	0.095
	Deutsch DT04-3P	XMEP060BT21F	0.098
	AMP Superseal 1.5 3-pin	XMEP060BV21F	0.098
0...10 V	M12	XMEP060BD71F	0.095
	Deutsch DT04-3P	XMEP060BT71F	0.098
	AMP Superseal 1.5 3-pin	XMEP060BV71F	0.098
0.5...4.5 V ratiometric	M12	XMEP060BD11F	0.095
	Deutsch DT04-3P	XMEP060BT11F	0.098
	AMP Superseal 1.5 3-pin	XMEP060BV11F	0.098

0 to 100 bar (0 to 1450 psi)

Maximum permissible accidental pressure: 300 bar, destruction pressure: 600 bar

Analogue output type	Electrical connection	Reference	Weight kg
G 1/4 A DIN 3852-E (male) fluid connection			
4...20 mA	M12	XMEP100BD21F	0.095
	Deutsch DT04-3P	XMEP100BT21F	0.098
	AMP Superseal 1.5 3-pin	XMEP100BV21F	0.098
0...10 V	M12	XMEP100BD71F	0.095
	Deutsch DT04-3P	XMEP100BT71F	0.098
	AMP Superseal 1.5 3-pin	XMEP100BV71F	0.098
0.5...4.5 V ratiometric	M12	XMEP100BD11F	0.095
	Deutsch DT04-3P	XMEP100BT11F	0.098
	AMP Superseal 1.5 3-pin	XMEP100BV11F	0.098

0 to 250 bar (0 to 3625 psi)

Maximum permissible accidental pressure: 750 bar, destruction pressure: 1500 bar

Analogue output type	Electrical connection	Reference	Weight kg
G 1/4 A DIN 3852-E (male) fluid connection			
4...20 mA	M12	XMEP250BD21F (1)	0.095
	Deutsch DT04-3P	XMEP250BT21F (1)	0.098
	AMP Superseal 1.5 3-pin	XMEP250BV21F (1)	0.098
	AMP Junior Power Timer 3-pin	XMEP250BJ21F (1)	0.098
0...10 V	M12	XMEP250BD71F (1)	0.095
	Deutsch DT04-3P	XMEP250BT71F (1)	0.098
	AMP Superseal 1.5 3-pin	XMEP250BV71F (1)	0.098
0.5...4.5 V ratiometric	M12	XMEP250BD11F (1)	0.095
	Deutsch DT04-3P	XMEP250BT11F (1)	0.098
	AMP Superseal 1.5 3-pin	XMEP250BV11F (1)	0.098
	AMP Junior Power Timer 3-pin	XMEP250BJ11F (1)	0.098

(1) Sold in lots of 25: add the letter Q to the end of the selected reference. For example, XMEP250BD21F becomes XMEP250BD21FQ.

Electronic pressure sensors

OsiSense XM

XMEP pressure transmitters for mobile equipments

With analogue output

Sizes in bar

XMEX_522_CPSCT16005



XMEP●00BD●1F

XMEX_522_CPSCT16004



XMEP●00BT●1F

XMEX_522_CPSCT16002



XMEP●00BV●1F

XMEX_522_CPSCT16001



XMEP400BJ●1F

0 to 400 bar (0 to 5800 psi)

Maximum permissible accidental pressure: 1200 bar, destruction pressure: 2400 bar

Analogue output type	Electrical connection	Reference	Weight kg
G 1/4 A DIN 3852-E (male) fluid connection			
4...20 mA	M12	XMEP400BD21F (1)	0.095
	Deutsch DT04-3P	XMEP400BT21F (1)	0.098
	AMP Superseal 1.5 3-pin	XMEP400BV21F (1)	0.098
	AMP Junior Power Timer 3-pin	XMEP400BJ21F (1)	0.098
0...10 V	M12	XMEP400BD71F (1)	0.095
	Deutsch DT04-3P	XMEP400BT71F (1)	0.098
	AMP Superseal 1.5 3-pin	XMEP400BV71F (1)	0.098
	0.5...4.5 V ratiometric	M12	XMEP400BD11F (1)
Deutsch DT04-3P		XMEP400BT11F (1)	0.098
AMP Superseal 1.5 3-pin		XMEP400BV11F (1)	0.098
AMP Junior Power Timer 3-pin		XMEP400BJ11F (1)	0.098

0 to 600 bar (0 to 8700 psi)

Maximum permissible accidental pressure: 1500 bar, destruction pressure: 2400 bar

Analogue output type	Electrical connection	Reference	Weight kg
G 1/4 A DIN 3852-E (male) fluid connection			
4...20 mA	M12	XMEP600BD21F	0.095
	Deutsch DT04-3P	XMEP600BT21F (1)	0.098
	AMP Superseal 1.5 3-pin	XMEP600BV21F	0.098
0...10 V	M12	XMEP600BD71F (1)	0.095
	Deutsch DT04-3P	XMEP600BT71F	0.098
	AMP Superseal 1.5 3-pin	XMEP600BV71F	0.098
0.5...4.5 V ratiometric	M12	XMEP600BD11F	0.095
	Deutsch DT04-3P	XMEP600BT11F	0.098
	AMP Superseal 1.5 3-pin	XMEP600BV11F	0.098

(1) Sold in lots of 25: add the letter Q to the end of the selected reference.
For example, **XMEP400BD21F** becomes **XMEP400BD21FQ**.

Electronic pressure sensors

OsiSense XM

XMEP pressure transmitters for mobile equipments

With analogue output

Sizes in psi

XMEP_522_CPSCT16003



XMEP●K●PT●30

0 to 1000 psi (0 to 69 bar)

Maximum permissible accidental pressure: 2200 psi, destruction pressure: 4400 psi

Analogue output type	Electrical connection	Reference	Weight kg
1/4" - 18NPT (male) fluid connection			
4...20 mA	Deutsch DT04-3P	XMEP1K0PT230	0.098
0...10 V	Deutsch DT04-3P	XMEP1K0PT730	0.098
0.5...4.5 V ratiometric	Deutsch DT04-3P	XMEP1K0PT130	0.098

0 to 3000 psi (0 to 207 bar)

Maximum permissible accidental pressure: 9000 psi, destruction pressure: 18,000 psi

Analogue output type	Electrical connection	Reference	Weight kg
1/4" - 18NPT (male) fluid connection			
4...20 mA	Deutsch DT04-3P	XMEP3K0PT230	0.098
0...10 V	Deutsch DT04-3P	XMEP3K0PT730	0.098
0.5...4.5 V ratiometric	Deutsch DT04-3P	XMEP3K0PT130	0.098

0 to 5000 psi (0 to 345 bar)

Maximum permissible accidental pressure: 15,000 psi, destruction pressure: 30,000 psi

Analogue output type	Electrical connection	Reference	Weight kg
1/4" - 18NPT (male) fluid connection			
4...20 mA	Deutsch DT04-3P	XMEP5K0PT230	0.098
0...10 V	Deutsch DT04-3P	XMEP5K0PT730	0.098
0.5...4.5 V ratiometric	Deutsch DT04-3P	XMEP5K0PT130	0.098

0 to 7500 psi (0 to 517 bar)

Maximum permissible accidental pressure: 18,750 psi, destruction pressure: 30,000 psi

Analogue output type	Electrical connection	Reference	Weight kg
1/4" - 18NPT (male) fluid connection			
4...20 mA	Deutsch DT04-3P	XMEP7K5PT230	0.098
0...10 V	Deutsch DT04-3P	XMEP7K5PT730	0.098
0.5...4.5 V ratiometric	Deutsch DT04-3P	XMEP7K5PT130	0.098

Electronic pressure sensors

OsiSense XM

XMEP pressure transmitters for mobile equipments

Separate parts



ZMLPA1•2SH

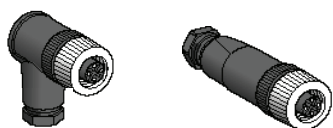

XZCC12FCM40B XZCC12FDM40B

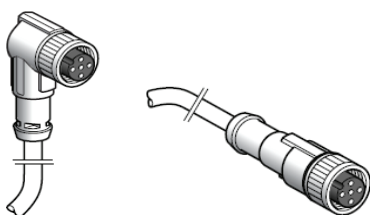

XZCP1241L5 XZCP1141L10

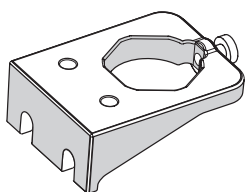

XMLZL017

Switches with display for pressure transmitters (1)

Analogue output type	Solid-state output type	Switching mode	Reference	Weight kg
4...20 mA	1 x PNP	Hysteresis	ZMLPA1P2SH	0.104
		Window	ZMLPA1P2SW	0.104
	1 x NPN	Hysteresis	ZMLPA1N2SH	0.104
		Window	ZMLPA1N2SW	0.104
–	2 x PNP	Hysteresis	ZMLPA2P0SH	0.104
–	2 x NPN	Hysteresis	ZMLPA2N0SH	0.104

Connection accessories (2)

Description	Type	Reference	Weight kg
M12 female connector metal clamping ring (3)	Straight	XZCC12FDM40B	0.020
	Elbowed	XZCC12FCM40B	0.020

Description	Cable length	Cable material	Reference	Weight kg
Pre-wired M12, straight, female connectors	2 m	PUR	XZCP1141L2	0.090
		PVC	XZCPV1141L2	0.110
	5 m	PUR	XZCP1141L5	0.190
		PVC	XZCPV1141L5	0.210
	10 m	PUR	XZCP1141L10	0.370
		PVC	XZCPV1141L10	0.390
Pre-wired M12, elbowed, female connectors	2 m	PUR	XZCP1241L2	0.090
		PVC	XZCPV1241L2	0.110
	5 m	PUR	XZCP1241L5	0.190
		PVC	XZCPV1241L5	0.210
	10 m	PUR	XZCP1241L10	0.370
		PVC	XZCPV1241L10	0.390

Mounting accessory

Description	For use with	Reference	Weight kg
Fixing bracket (aluminium)	All XMEP transmitters	XMLZL017	0.029

(1) ZMLP switches are compatible with pressure transmitters with 4...20 mA analogue output and M12 connector. See XMEP•••0BD21F pressure transmitters with male M12 connector (pages 40 and 41).

(2) For XMEP•••••D••• pressure transmitters with male M12 connector.

(3) Connector with screw terminal connections.



Example of remote mounting (with jumper cable and fixing bracket).

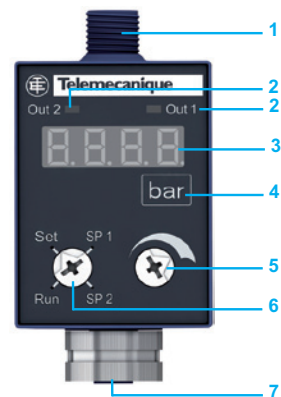
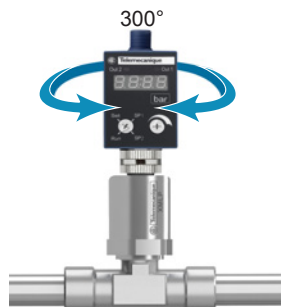

Presentation

Combined with a pressure transmitter, the ZMLP switch with display converts an analogue signal into one or two switching outputs with adjustable thresholds. It can also be used to display the measured pressure. One of 27 display ranges, from -14.5 to 6000, can be selected for this purpose, meaning the switch can adapt to the majority of pressure transmitters, whether calibrated in bar, psi or pascal.

Depending on the model, ZMLP switches with display are available with different output configurations:

- One 4...20 mA analogue output and one switching output, PNP or NPN type, hysteresis or window switching mode.
- Two switching outputs, PNP or NPN type, hysteresis switching mode (fixed hysteresis).

Compact and robust:

Its compact housing made of Valox™ PBT and polyester front face provide it with IP65, IP67 and IP69K degrees of protection, making it suitable for the harshest environments. These products are for a nominal supply voltage of 24 V $\overline{\text{DC}}$ and have a 17 to 33 V $\overline{\text{DC}}$ operating range.

Simplicity of setup:

These products must be connected to an electronic pressure transmitter with 4...20 mA analogue output and 4-pin M12 connector.

They can be mounted:

- Directly on the pressure transmitter. The product body can then pivot through 300°, enabling optimum orientation of the display and settings.
- Or mounted remotely, up to 20 metres from the transmitter, using a simple jumper cable. In this case, clever design accessories allow the product to be fixed in place quickly, horizontally, vertically or even directly on the pressure inlet pipe.

Description

- 1 4-pin male M12 output connector, for connection to an automation platform.
- 2 Indicator LEDs displaying the output status (LED lit when the output has been activated).
- 3 7-segment/4-digit display.
- 4 Pressure unit indication, bar by default, psi, kPa or MPa by the addition of an adhesive label supplied with the product.
- 5 Potentiometer for selecting the display size and adjusting the switching threshold values.
- 6 4-position rotary switch for selecting the parameter to be configured.
- 7 4-pin female M12 connector, for connection to the pressure transmitter.

Functions

Configurable functions

For the display:

- Pressure unit (bar, psi, kPa and MPa)
- 27 display ranges can be selected, from -14.5 to 6000

For the solid-state output(s):

- NO or NC contact

Locking/unlocking:

- In order to avoid losing the product settings accidentally, the product can be locked. The settings cannot then be changed

Fast diagnostic function

- Illumination of all the display segments on each power-up, enabling checking of their operation

Electronic pressure sensors

OsiSense XM

ZMLP switches with 4-digit display



ZMLPA1●2SH



ZMLPA1●2SW



ZMLPA2●0SH



XMLPZLH01



XMLPZLV01

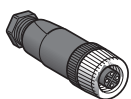

XZCC12FDM40B

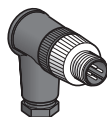

XZCC12MCM40B

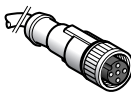

XZCP1141L●

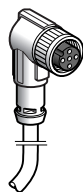

XZCP1241L●

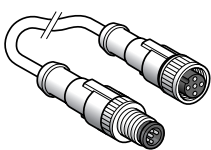

XZCR1511040A●

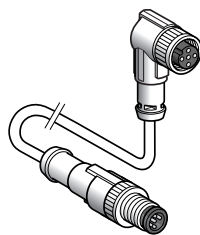

XZCR1512040A●

Switches with a display for OsiSense XMLP pressure sensors (1)

Analogue output type	Solid-state output type	Switching mode	Reference	Weight kg
4...20 mA	1 x PNP	Hysteresis	ZMLPA1P2SH	0.104
		Window	ZMLPA1P2SW	0.104
	1 x NPN	Hysteresis	ZMLPA1N2SH	0.104
		Window	ZMLPA1N2SW	0.104
-	2 x PNP	Hysteresis	ZMLPA2P0SH	0.104
	2 x NPN	Hysteresis	ZMLPA2N0SH	0.104

Fixing brackets for ZMLP switches with display

Description	Reference	Weight kg
Metal bracket for fixing horizontally	XMLPZLH01	0.012
Metal bracket for fixing vertically or on an inlet pipe	XMLPZLV01	0.024

Cabling accessories

Type	Length of cable m	Reference	Weight kg
4-pin M12 connectors, for connection on screw terminals (2)			
Straight female connector	-	XZCC12FDM40B	0.020
Elbowed female connector	-	XZCC12FCM40B	0.020
Straight male connector	-	XZCC12MDM40B	0.025
Elbowed male connector	-	XZCC12MCM40B	0.025

Pre-wired M12, 4-pin connectors (PUR cable)

Straight female connector	2	XZCP1141L2	0.090
	5	XZCP1141L5	0.190
	10	XZCP1141L10	0.370
	15	XZCP1141L15	0.500
	20	XZCP1141L20	0.750
Elbowed female connector	2	XZCP1241L2	0.090
	5	XZCP1241L5	0.190
	10	XZCP1241L10	0.370
	15	XZCP1241L15	0.500
	20	XZCP1241L20	0.750

M12-M12, 3-pin jumper cables (PUR cable) (2)

Straight male and female connectors	1	XZCR1511040A1	0.065
	2	XZCR1511040A2	0.095
Straight male connector, elbowed female connector	1	XZCR1512040A1	0.065
	2	XZCR1512040A2	0.095

(1) For XMLP●●●●D2● pressure transmitters (see pages 24 to 36).

Switches with display are also compatible with XMLK●●●●2D2● and XMLG●●●●D2● pressure transmitters (see pages 14 to 20).

(2) For connecting the pressure transmitter to the switch with display, in the case of remote mounting.

Electronic pressure sensors

OsiSense XM

XMLR pressure sensors with 4-digit display

OsiSense XMLR

Electronic pressure sensors are used to control and measure pressure or vacuum levels in hydraulic or pneumatic systems. They convert the pressure into an electrical signal. They then produce an analogue output which is proportional to the measured pressure and/or one or two switching outputs on which the switching point is adjustable.

The high precision and performance of OsiSense XMLR pressure sensors makes them suitable for numerous industrial applications requiring display, control or regulation of pressure/vacuum levels.

Easy to mount

XMLR pressure sensors minimise installation time and effort. Their compact-sized, rotating body and "flip over display" function make mounting easy and flexible.

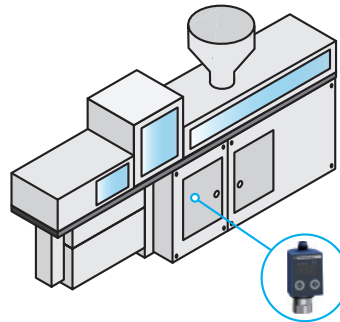

With its compact size, the OsiSense XMLR pressure sensor is easily integrated into the machine

Compact format

> With a height of just 88 to 100 mm depending on the pressure range and the fluid entry type, OsiSense XMLR is one of the most compact pressure switches on the market.



Rotating body

> The body of the OsiSense XMLR pressure sensor can be rotated 300°, thus enabling the user to orientate the front face of the product as required following connection to the pressure inlet pipe.



Easy to mount (continued)

Flip over display function.

> The display can be inverted vertically to adapt to the sensor's installation position.

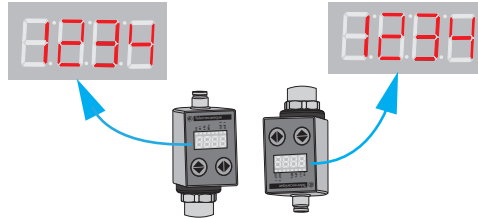

Easy to set up

Menu naming and structure based on the VDMA* standard

> The ergonomic design of OsiSense XMLR sets a new standard for ease of configuration.

Navigation using just two pushbuttons

> Two simple pushbuttons are all that is needed to navigate through an intuitive menu structured according to the VDMA* 24574-1 standard.



- 1 Pushbutton to display a value or parameter or to save a selected value or parameter and return to the menu.
- 2 Pushbutton to scroll from one menu to another or to increase a value or change a parameter.

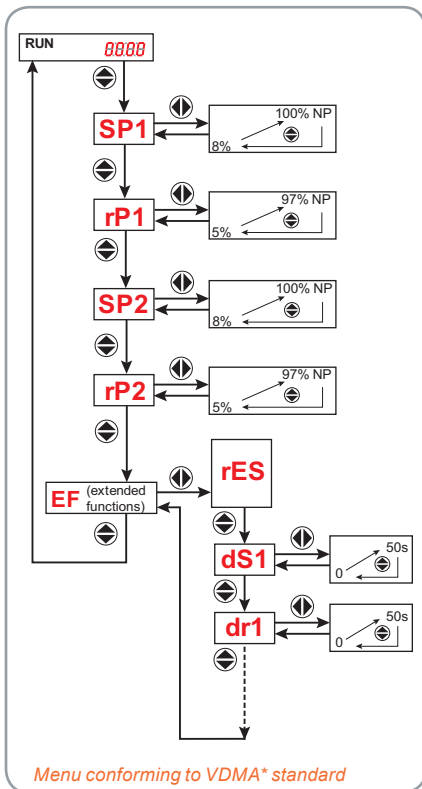

Easy to maintain

At each device start up, all segments of the display light up briefly to confirm that it is operating correctly.

The device can be tested using a diagnostic function which checks the whole electronic signal processing chain. This function is accessible via the "Dia" menu and the result of the test is indicated on the display (DONE or ERR).

For transmitters, this function can also be remotely activated by connecting the Test input to an automation platform, thus enabling automatic verification without the need for intervention by an operator.

In this instance, the self-test also generates an analogue output signal which is equivalent to 50% of the sensor size (12 mA or 5 V) which, in turn, can be verified by the automation platform.

The pressure sensor can be considered as defective if the difference between the signal transmitted and the standard theoretical value is too great.

OsiSense XMLR pressure sensors also include a recording of the high and low pressure values measured since the last reset. These values can be displayed via the Hi and Lo menus.

* VDMA: Verband Deutscher Maschinen und Anlagenbau e.V.

Electronic pressure sensors

OsiSense XM

XMLR pressure sensors with 4-digit display.
Compact plastic body, stainless steel 316L fluid entry.
With analogue and solid-state outputs.

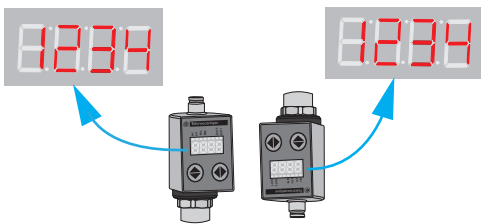

"Flip over display" function.

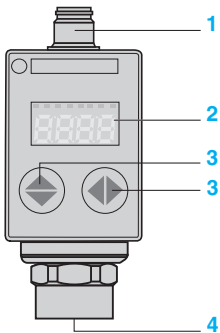

Presentation

XMLR electronic pressure sensors are used for pressure control of hydraulic oils, fresh water, air and refrigeration fluids, between -1 and 600 bar.

Depending on the model, XMLR sensors are available with different output configurations in order to meet the highest number of requirements:

- One analogue output, 4...20 mA or 0...10 V, proportional to the measuring range
- One analogue output and one switching output, PNP or NPN type
- Two switching outputs, PNP or NPN type
- One 4...20 mA analogue output and two switching outputs, PNP or NPN type

Compact and robust:

The stainless steel 316L fluid entry and fibreglass impregnated polyacrylamide body provide the XMLR pressure sensors with excellent mechanical resistance, improved corrosion resistance and an P65/IP67 degree of protection. Compact in size (88 mm to 100 mm overall, depending on model), these products are for a nominal supply voltage of 24 V $\overline{\text{DC}}$ and have a 17 to 33 V $\overline{\text{DC}}$ operating range.

They are particularly suitable for:

- Moulding and thermoforming presses
- Injection machines
- Pneumatic systems and assembly machinery
- Hydraulic systems of lifting and handling equipment
- Pumping and fresh water treatment

Simplicity of setting-up

The body of the OsiSense XMLR pressure sensor can be turned through 300°, thus enabling the front face of the product to be orientated as required following connection to the pressure inlet pipe.

In addition, the "flip over display" function simplifies reading in the event of upside down mounting (fluid entry from above).

Description

- 1 M12 male connector, 4 or 5-pin depending on model.
- 2 4-digit, 7-segment display and LED indicator for pressure and output state (LED lit when the output has been activated).
- 3 Navigation keys for setting and configuring the menus (conforming to VDMA 24574).
- 4 Fluid entry: G 1/4 female, 1/4"-18 NPT female or SAE 7/16-20UNF female, depending on model.

Functions

Configurable functions

For the display:

- Pressure unit of measurement (bar, psi, kPa or MPa)
- Display refresh time: fast (50 ms), normal (200 ms), slow (600 ms)
- 180° flip over display
- Display off, power saving mode

For the analogue output (4...20 mA or 0...10 V):

- Compensation offset in the range of $\pm 5\%$ of the units size
- Adjustment of pressure between 75 and 125% of the nominal pressure

For each solid-state output:

- NO or NC contact
- Switching mode of outputs: Hysteresis (pumping) or Window (control)
- Time delay both on trip and on reset (adjustable from 0 to 50 s, in steps of 1 s)

Locking/unlocking:

- In order to avoid losing the product settings accidentally, the product can be locked. The settings cannot then be changed

Fast diagnostic functions

- Illumination of all the display segments on each power-up, enabling checking of their operation
- Diagnostic function for checking correct operation of the sensor
- Saving of min. and max. pressures measured by the sensor, up to 125% of the nominal pressure, and their subsequent display

Electronic pressure sensors

OsiSense XM

XMLR pressure sensors with 4-digit display.
Compact plastic body, stainless steel 316L fluid entry.
With analogue and solid-state outputs.



XMLR●●●G●●●5



XMLR●●●G●●●6

-1 to 0 bar (-14.5 to 0 psi)

Maximum permissible accidental pressure: 3 bar, destruction pressure: 3 bar

Analogue output type	Solid-state output type	Reference	Weight kg
G 1/4 DIN 3852-Y (female) fluid connection			
4...20 mA	–	XMLRM01G0T25	0.190
0...10 V	–	XMLRM01G0T75	0.190
4...20 mA	1 x PNP	XMLRM01G1P25	0.190
4...20 mA	1 x NPN	XMLRM01G1N25	0.190
0...10 V	1 x PNP	XMLRM01G1P75	0.190
0...10 V	1 x NPN	XMLRM01G1N75	0.190
–	2 x PNP	XMLRM01G2P05	0.190
–	2 x NPN	XMLRM01G2N05	0.190
4...20 mA	2 x PNP	XMLRM01G2P25	0.190
4...20 mA	2 x NPN	XMLRM01G2N25	0.190

1/4" - 18 NPT (female) fluid connection

4...20 mA	–	XMLRM01G0T26	0.212
4...20 mA	1 x PNP	XMLRM01G1P26	0.212
4...20 mA	1 x NPN	XMLRM01G1N26	0.212
–	2 x PNP	XMLRM01G2P06	0.212
–	2 x NPN	XMLRM01G2N06	0.212
4...20 mA	2 x PNP	XMLRM01G2P26	0.212
4...20 mA	2 x NPN	XMLRM01G2N26	0.212

0 to 1 bar (0 to 14.5 psi)

Maximum permissible accidental pressure: 7 bar, destruction pressure: 7 bar

Analogue output type	Solid-state output type	Reference	Weight kg
G 1/4 DIN 3852-Y (female) fluid connection			
4...20 mA	–	XMLR001G0T25	0.190
0...10 V	–	XMLR001G0T75	0.190
4...20 mA	1 x PNP	XMLR001G1P25	0.190
4...20 mA	1 x NPN	XMLR001G1N25	0.190
0...10 V	1 x PNP	XMLR001G1P75	0.190
0...10 V	1 x NPN	XMLR001G1N75	0.190
–	2 x PNP	XMLR001G2P05	0.190
–	2 x NPN	XMLR001G2N05	0.190
1/4" - 18 NPT (female) fluid connection			
4...20 mA	–	XMLR001G0T26	0.212
0...10 V	–	XMLR001G0T76	0.212
4...20 mA	1 x PNP	XMLR001G1P26	0.212
4...20 mA	1 x NPN	XMLR001G1N26	0.212
–	2 x PNP	XMLR001G2P06	0.212
–	2 x NPN	XMLR001G2N06	0.212

0 to 2.5 bar (0 to 36.2 psi)

Maximum permissible accidental pressure: 12 bar, destruction pressure: 12 bar

Analogue output type	Solid-state output type	Reference	Weight kg
G 1/4 DIN 3852-Y (female) fluid connection			
4...20 mA	–	XMLR2D5G0T25	0.190
0...10 V	–	XMLR2D5G0T75	0.190
4...20 mA	1 x PNP	XMLR2D5G1P25	0.190
4...20 mA	1 x NPN	XMLR2D5G1N25	0.190
0...10 V	1 x PNP	XMLR2D5G1P75	0.190
0...10 V	1 x NPN	XMLR2D5G1N75	0.190
–	2 x PNP	XMLR2D5G2P05	0.190
–	2 x NPN	XMLR2D5G2N05	0.190
1/4" - 18 NPT (female) fluid connection			
4...20 mA	1 x PNP	XMLR2D5G1P26	0.212
4...20 mA	1 x NPN	XMLR2D5G1N26	0.212
–	2 x PNP	XMLR2D5G2P06	0.212
–	2 x NPN	XMLR2D5G2N06	0.212

Electronic pressure sensors

OsiSense XM

XMLR pressure sensors with 4-digit display.
Compact plastic body, stainless steel 316L fluid entry.
With analogue and solid-state outputs.



XMLR●●●G●●●5



XMLR●●●G●●●6
XMLR●●●G●●●9

0 to 10 bar (0 to 145 psi)			
Maximum permissible accidental pressure: 40 bar, destruction pressure: 40 bar			
Analogue output type	Solid-state output type	Reference	Weight kg
G 1/4 DIN 3852-Y (female) fluid connection			
4...20 mA	–	XMLR010G0T25	0.190
0...10 V	–	XMLR010G0T75	0.190
4...20 mA	1 x PNP	XMLR010G1P25	0.190
4...20 mA	1 x NPN	XMLR010G1N25	0.190
0...10 V	1 x PNP	XMLR010G1P75	0.190
0...10 V	1 x NPN	XMLR010G1N75	0.190
–	2 x PNP	XMLR010G2P05	0.190
–	2 x NPN	XMLR010G2N05	0.190
4...20 mA	2 x PNP	XMLR010G2P25	0.190
4...20 mA	2 x NPN	XMLR010G2N25	0.190
1/4''- 18 NPT (female) fluid connection			
4...20 mA	–	XMLR010G0T26	0.212
0...10 V	–	XMLR010G0T76	0.212
4...20 mA	1 x PNP	XMLR010G1P26	0.212
4...20 mA	1 x NPN	XMLR010G1N26	0.212
0...10 V	1 x PNP	XMLR010G1P76	0.212
0...10 V	1 x NPN	XMLR010G1N76	0.212
–	2 x PNP	XMLR010G2P06	0.212
–	2 x NPN	XMLR010G2N06	0.212
4...20 mA	2 x PNP	XMLR010G2P26	0.212
4...20 mA	2 x NPN	XMLR010G2N26	0.212
SAE 7/16-20UNF-2B (female) fluid connection			
–	2 x PNP	XMLR010G2P09	0.210
–	2 x NPN	XMLR010G2N09	0.210
0 to 16 bar (0 to 232 psi)			
Maximum permissible accidental pressure: 62 bar, destruction pressure: 62 bar			
Analogue output type	Solid-state output type	Reference	Weight kg
G 1/4 DIN 3852-Y (female) fluid connection			
4...20 mA	–	XMLR016G0T25	0.190
0...10 V	–	XMLR016G0T75	0.190
4...20 mA	1 x PNP	XMLR016G1P25	0.190
4...20 mA	1 x NPN	XMLR016G1N25	0.190
0...10 V	1 x PNP	XMLR016G1P75	0.190
–	2 x PNP	XMLR016G2P05	0.190
4...20 mA	2 x PNP	XMLR016G2P25	0.190
1/4''- 18 NPT (female) fluid connection			
4...20 mA	–	XMLR016G0T26	0.212
4...20 mA	1 x PNP	XMLR016G1P26	0.212
4...20 mA	1 x NPN	XMLR016G1N26	0.212
–	2 x PNP	XMLR016G2P06	0.212
–	2 x NPN	XMLR016G2N06	0.212
0 to 25 bar (0 to 362 psi)			
Maximum permissible accidental pressure: 100 bar, destruction pressure: 100 bar			
Analogue output type	Solid-state output type	Reference	Weight kg
G 1/4 DIN 3852-Y (female) fluid connection			
4...20 mA	–	XMLR025G0T25	0.190
0...10 V	–	XMLR025G0T75	0.190
4...20 mA	1 x PNP	XMLR025G1P25	0.190
4...20 mA	1 x NPN	XMLR025G1N25	0.190
0...10 V	1 x PNP	XMLR025G1P75	0.190
0...10 V	1 x NPN	XMLR025G1N75	0.190
–	2 x PNP	XMLR025G2P05	0.190
–	2 x NPN	XMLR025G2N05	0.190
1/4''- 18 NPT (female) fluid connection			
4...20 mA	–	XMLR025G0T26	0.212
4...20 mA	1 x PNP	XMLR025G1P26	0.212
4...20 mA	1 x NPN	XMLR025G1N26	0.212
–	2 x PNP	XMLR025G2P06	0.212
–	2 x NPN	XMLR025G2N06	0.212

Electronic pressure sensors

OsiSense XM

XMLR pressure sensors with 4-digit display.

Compact plastic body, stainless steel 316L fluid entry.

With analogue and solid-state outputs.



XMLR●●●G●●●5



XMLR●●●G●●●6

XMLR●●●M●●●5
XMLR●●●M●●●6

XMLR●●●M●●●9

0 to 40 bar (0 to 580 psi)

Maximum permissible accidental pressure: 150 bar, destruction pressure: 150 bar

Analogue output type	Solid-state output type	Reference	Weight kg
G 1/4 DIN 3852-Y (female) fluid connection			
4...20 mA	–	XMLR040G0T25	0.190
0...10 V	–	XMLR040G0T75	0.190
4...20 mA	1 x PNP	XMLR040G1P25	0.190
4...20 mA	1 x NPN	XMLR040G1N25	0.190
0...10 V	1 x PNP	XMLR040G1P75	0.190
0...10 V	1 x NPN	XMLR040G1N75	0.190
–	2 x PNP	XMLR040G2P05	0.190
–	2 x NPN	XMLR040G2N05	0.190
4...20 mA	2 x PNP	XMLR040G2P25	0.190
4...20 mA	2 x NPN	XMLR040G2N25	0.190

1/4"- 18 NPT (female) fluid connection

4...20 mA	–	XMLR040G0T26	0.212
4...20 mA	1 x PNP	XMLR040G1P26	0.212
4...20 mA	1 x NPN	XMLR040G1N26	0.212
–	2 x PNP	XMLR040G2P06	0.212
–	2 x NPN	XMLR040G2N06	0.212

0 to 100 bar (0 to 1450 psi)

Maximum permissible accidental pressure: 300 bar, destruction pressure: 600 bar

Analogue output type	Solid-state output type	Reference	Weight kg
G 1/4 DIN 3852-Y (female) fluid connection			
4...20 mA	–	XMLR100M0T25	0.186
0...10 V	–	XMLR100M0T75	0.186
4...20 mA	1 x PNP	XMLR100M1P25	0.186
4...20 mA	1 x NPN	XMLR100M1N25	0.186
0...10 V	1 x PNP	XMLR100M1P75	0.186
0...10 V	1 x NPN	XMLR100M1N75	0.186
–	2 x PNP	XMLR100M2P05	0.186
–	2 x NPN	XMLR100M2N05	0.186
1/4"- 18 NPT (female) fluid connection			
4...20 mA	–	XMLR100M0T26	0.186
4...20 mA	1 x PNP	XMLR100M1P26	0.186
4...20 mA	1 x NPN	XMLR100M1N26	0.186
–	2 x PNP	XMLR100M2P06	0.186
–	2 x NPN	XMLR100M2N06	0.186

0 to 160 bar (0 to 2320 psi)

Maximum permissible accidental pressure: 480 bar, destruction pressure: 960 bar

Analogue output type	Solid-state output type	Reference	Weight kg
G 1/4 DIN 3852-Y (female) fluid connection			
4...20 mA	–	XMLR160M0T25	0.186
0...10 V	–	XMLR160M0T75	0.186
4...20 mA	1 x PNP	XMLR160M1P25	0.186
4...20 mA	1 x NPN	XMLR160M1N25	0.186
0...10 V	1 x PNP	XMLR160M1P75	0.186
0...10 V	1 x NPN	XMLR160M1N75	0.186
–	2 x PNP	XMLR160M2P05	0.186
–	2 x NPN	XMLR160M2N05	0.186
SAE 7/16-20UNF-2B (female) fluid connection			
–	2 x PNP	XMLR160M2P09	0.212
–	2 x NPN	XMLR160M2N09	0.212

Electronic pressure sensors

OsiSense XM

XMLR pressure sensors with 4-digit display.
Compact plastic body, stainless steel 316L fluid entry.
With analogue and solid-state outputs.



XMLR●●●M●●●5
XMLR●●●M●●●6



XMLR●●●M●●●9

0 to 250 bar (0 to 3625 psi)

Maximum permissible accidental pressure: 750 bar, destruction pressure: 1500 bar

Analogue output type	Solid-state output type	Reference	Weight kg
G 1/4 DIN 3852-Y (female) fluid connection			
4...20 mA	–	XMLR250M0T25	0.186
0...10 V	–	XMLR250M0T75	0.186
4...20 mA	1 x PNP	XMLR250M1P25	0.186
4...20 mA	1 x NPN	XMLR250M1N25	0.186
0...10 V	1 x PNP	XMLR250M1P75	0.186
0...10 V	1 x NPN	XMLR250M1N75	0.186
–	2 x PNP	XMLR250M2P05	0.186
–	2 x NPN	XMLR250M2N05	0.186
4...20 mA	2 x PNP	XMLR250M2P25	0.186
4...20 mA	2 x NPN	XMLR250M2N25	0.186

1/4" - 18 NPT (female) fluid connection

4...20 mA	–	XMLR250M0T26	0.186
4...20 mA	1 x PNP	XMLR250M1P26	0.186
4...20 mA	1 x NPN	XMLR250M1N26	0.186
0...10 V	1 x PNP	XMLR250M1P76	0.186
–	2 x PNP	XMLR250M2P06	0.186
–	2 x NPN	XMLR250M2N06	0.186

SAE 7/16-20UNF-2B (female) fluid connection

–	2 x PNP	XMLR250M2P09	0.212
–	2 x NPN	XMLR250M2N09	0.212

0 to 400 bar (0 to 5800 psi)

Maximum permissible accidental pressure: 1200 bar, destruction pressure: 2400 bar

Analogue output type	Solid-state output type	Reference	Weight kg
G 1/4 DIN 3852-Y (female) fluid connection			
4...20 mA	–	XMLR400M0T25	0.186
0...10 V	–	XMLR400M0T75	0.186
4...20 mA	1 x PNP	XMLR400M1P25	0.186
4...20 mA	1 x NPN	XMLR400M1N25	0.186
0...10 V	1 x PNP	XMLR400M1P75	0.186
0...10 V	1 x NPN	XMLR400M1N75	0.186
–	2 x PNP	XMLR400M2P05	0.186
–	2 x NPN	XMLR400M2N05	0.186
4...20 mA	2 x PNP	XMLR400M2P25	0.186
4...20 mA	2 x NPN	XMLR400M2N25	0.186

1/4" - 18 NPT (female) fluid connection

4...20 mA	–	XMLR400M0T26	0.186
4...20 mA	1 x PNP	XMLR400M1P26	0.186
4...20 mA	1 x NPN	XMLR400M1N26	0.186
–	2 x PNP	XMLR400M2P06	0.186
–	2 x NPN	XMLR400M2N06	0.186

0 to 600 bar (0 to 8700 psi)

Maximum permissible accidental pressure: 1500 bar, minimum destruction pressure: 2500 bar

Analogue output type	Solid-state output type	Reference	Weight kg
Fluid connection G 1/4 (female)			
4...20 mA	–	XMLR600M0T25	0.186
0...10 V	–	XMLR600M0T75	0.186
4...20 mA	1 x PNP	XMLR600M1P25	0.186
0...10 V	1 x PNP	XMLR600M1P75	0.186
–	2 x PNP	XMLR600M2P05	0.186

Electronic pressure sensors

OsiSense XM

XMLR pressure sensors with 4-digit display

Accessories



XMLZL009

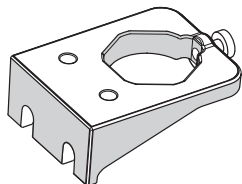

XMLZL017

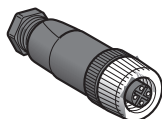

XZCC12FDM●0B



XZCC12FCM●0B

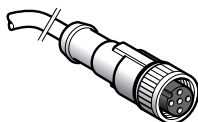

XZCP1141L●

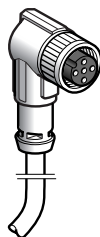

XZCP1241L●

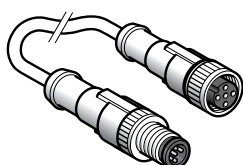

XZCR15110●●●●

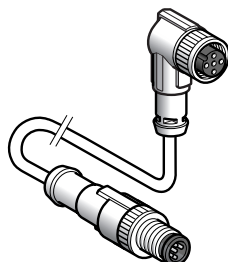

XZCR15120●●●●

Accessories

Description	For use with	Reference	Weight kg
Cooler with G 1/4 A (male) connections Usage temperature: 150°C max. for the fluid, 50°C for the ambient air	XMLR●●●●●●●●5	XMLZL009	0.370
Fixing bracket aluminium	XMLR●●●	XMLZL017	0.029

Connectors

Description	For use with	Type	Reference	Weight kg
M12 female connector, 4-pin	XMLR●●●●0T●● XMLR●●●●1P●● XMLR●●●●1N●●	Straight	XZCC12FDM40B	0.020
Metal clamping ring	XMLR●●●●2P0● XMLR●●●●2N0●	Elbowed	XZCC12FCM40B	0.020
M12 female connector, 5-pin	XMLR●●●●2P2● XMLR●●●●2N2●	Straight	XZCC12FDM50B	0.020
Metal clamping ring		Elbowed	XZCC12FCM50B	0.020

Pre-wired connectors and jumper cables

Description	For use with	Type	Length of cable		Reference	Weight kg
			m	kg		
Pre-wired M12, 4-pin connectors Metal clamping ring PUR cable	XMLR●●●●0T●● XMLR●●●●1●●●● XMLR●●●●2P0● XMLR●●●●2N0●	Straight	2		XZCP1141L2	0.090
			5		XZCP1141L5	0.190
			10		XZCP1141L10	0.370
		Elbowed	2		XZCP1241L2	0.090
			5		XZCP1241L5	0.190
			10		XZCP1241L10	0.370
Pre-wired M12, 5-pin connectors PVC cable	XMLR●●●●2P2● XMLR●●●●2N2●	Straight female connector	2		XZCPV11V12L2	0.100
			5		XZCPV11V12L5	0.200
			10		XZCPV11V12L10	0.400
		Elbowed female connector	2		XZCPV12V12L2	0.100
			5		XZCPV12V12L5	0.200
			10		XZCPV12V12L10	0.400
M12-M12 4-pin jumper cables PUR cable	XMLR●●●●0T●● XMLR●●●●1●●●● XMLR●●●●2P0● XMLR●●●●2N0●	Straight female connector	1		XZCR1511041C1	0.100
			2		XZCR1511041C2	0.100
		Elbowed female connector	1		XZCR1512041C1	0.100
			2		XZCR1512041C2	0.100
M12-M12 5-pin jumper cables PUR cable	XMLR●●●●2P2● XMLR●●●●2N2●	Straight female connector	1		XZCR1511064D1	0.100
			2		XZCR1511064D2	0.100
		Elbowed female connector	1		XZCR1512064D1	0.100
			2		XZCR1512064D2	0.100

X					
XMEP1K0PT130	42	XMLEZ250	37	XMLK150P2D73	16
XMEP1K0PT230	42	XMLEZ600	37	XMLK150P2P23	16
XMEP1K0PT730	42	XMLEZM01	37	XMLK200P2C23	16
XMEP3K0PT130	42	XMLG001D21	19	XMLK200P2C73	16
XMEP3K0PT230	42	XMLG001D23	19	XMLK200P2D23	16
XMEP3K0PT730	42	XMLG001D71	19	XMLK200P2D73	16
XMEP5K0PT130	42	XMLG001D73TQ	19	XMLK200P2P23	16
XMEP5K0PT230	42	XMLG006D21	19	XMLK300P2C23	16
XMEP5K0PT730	42	XMLG006D23	19	XMLK300P2C73	16
XMEP7K5PT130	42	XMLG006D71	19	XMLK300P2D23	16
XMEP7K5PT230	42	XMLG006D73TQ	19	XMLK300P2D73	16
XMEP7K5PT730	42	XMLG010D21	19	XMLK300P2P23	16
XMEP060BD11F	40	XMLG010D23	19	XMLP001GC2BF	26
XMEP060BD21F	40	XMLG010D71	19	XMLP001GC7BF	26
XMEP060BD71F	40	XMLG010D73	19	XMLP001GC11F	26
XMEP060BT11F	40	XMLG010D73TQ	20	XMLP001GC21F	26
XMEP060BT21F	40	XMLG010Q21TQ	19	XMLP001GC71F	26
XMEP060BT71F	40	XMLG010Q71TQ	19	XMLP001GD2BF	26
XMEP060BV11F	40	XMLG016D21	20	XMLP001GD7BF	26
XMEP060BV21F	40	XMLG016D23	20	XMLP001GD11F	26
XMEP060BV71F	40	XMLG016D71	20	XMLP001GD21F	26
XMEP100BD11F	40	XMLG025D21	20	XMLP001GD71F	26
XMEP100BD21F	40	XMLG025D23	20	XMLP001GL21F	26
XMEP100BD71F	40	XMLG025D71	20	XMLP001GL71F	26
XMEP100BT11F	40	XMLG025D73TQ	20	XMLP1K0PD130	35
XMEP100BT21F	40	XMLG025Q21TQ	20	XMLP1K0PD230	35
XMEP100BT71F	40	XMLG100D21	20	XMLP1K0PD730	35
XMEP100BV11F	40	XMLG100D23	20	XMLP1K0PP230	35
XMEP100BV21F	40	XMLG100D71	20	XMLP1K0PP730	35
XMEP100BV71F	40	XMLG100D73TQ	20	XMLP2D5GC11F	27
XMEP250BD11F	40	XMLG100Q21TQ	20	XMLP2D5GC21F	27
XMEP250BD21F	40	XMLG250D21	20	XMLP2D5GC71F	27
XMEP250BD71F	40	XMLG250D23	20	XMLP2D5GD11F	27
XMEP250BJ11F	40	XMLG250D71	20	XMLP2D5GD21F	27
XMEP250BJ21F	40	XMLG250D73TQ	20	XMLP2D5GD71F	27
XMEP250BT11F	40	XMLG400D21	20	XMLP2D5GL21F	27
XMEP250BT21F	40	XMLG400D23	20	XMLP2D5GL71F	27
XMEP250BT71F	40	XMLG400D71	20	XMLP2K0PD130	36
XMEP250BV11F	40	XMLG400D73TQ	20	XMLP2K0PD230	36
XMEP250BV21F	40	XMLGM01D21	19	XMLP2K0PD730	36
XMEP250BV71F	40	XMLGM01D23	19	XMLP3K0PD130	36
XMEP400BD11F	41	XMLGM01D71	19	XMLP3K0PD230	36
XMEP400BD21F	41	XMLGM01D73TQ	19	XMLP3K0PD730	36
XMEP400BD71F	41	XMLGZ001	21	XMLP3K0PP230	36
XMEP400BJ11F	41	XMLK006B2C21	15	XMLP3K0PP730	36
XMEP400BJ21F	41	XMLK006B2C71	15	XMLP004GC11F	27
XMEP400BT11F	41	XMLK006B2D21	15	XMLP004GC21F	27
XMEP400BT21F	41	XMLK006B2D71	15	XMLP004GC71F	27
XMEP400BT71F	41	XMLK010B2C21	15	XMLP004GD11F	27
XMEP400BV11F	41	XMLK010B2C71	15	XMLP004GD21F	27
XMEP400BV21F	41	XMLK010B2D21	15	XMLP004GD71F	27
XMEP400BV71F	41	XMLK010B2D71	15	XMLP006GC11F	27
XMEP600BD11F	41	XMLK016B2C21	15	XMLP006GC21F	27
XMEP600BD21F	41	XMLK016B2C71	15	XMLP006GC71F	27
XMEP600BD71F	41	XMLK016B2D21	15	XMLP006GD11F	27
XMEP600BT11F	41	XMLK016B2D71	15	XMLP006GD21F	27
XMEP600BT21F	41	XMLK025B2C21	15	XMLP006GD71F	27
XMEP600BT71F	41	XMLK025B2C71	15	XMLP006GL21F	27
XMEP600BV11F	41	XMLK025B2D21	15	XMLP006GL71F	27
XMEP600BV21F	41	XMLK025B2D71	15	XMLP6K0PD130	36
XMEP600BV71F	41	XMLK100P2C23	16	XMLP6K0PD230	36
XMLEZ001	37	XMLK100P2C73	16	XMLP6K0PD730	36
XMLEZ010	37	XMLK100P2D23	16	XMLP6K0PP130	36
XMLEZ025	37	XMLK100P2D73	16	XMLP6K0PP730	36
XMLEZ060	37	XMLK150P2C23	16	XMLP010BC11F	28
XMLEZ060	37	XMLK150P2C73	16	XMLP010BC21F	28
XMLEZ100	37	XMLK150P2D23	16	XMLP010BC71F	30
				XMLP010BC270	28
				XMLP010BC290	28
				XMLP010BC790	28
				XMLP010BD11F	28
				XMLP010BD21F	28
				XMLP010BD71F	28
				XMLP010BD190	28
				XMLP010BD270	28
				XMLP010BD790	28
				XMLP015RC23F	33
				XMLP015RC73F	33
				XMLP015RD23F	33
				XMLP015RD73F	33
				XMLP015RP23F	33
				XMLP015RP73F	33
				XMLP016BC11F	28
				XMLP016BC21F	28
				XMLP016BC71F	28
				XMLP016BC270	28
				XMLP016BC290	28
				XMLP016BD11F	28
				XMLP016BD21F	28
				XMLP016BD71F	28
				XMLP016BD190	28
				XMLP016BD270	28
				XMLP016BD290	28
				XMLP016BD790	28
				XMLP025BC11F	29
				XMLP025BC21F	29
				XMLP025BC71F	29
				XMLP025BC270	29
				XMLP025BC290	29
				XMLP025BD11F	29
				XMLP025BD21F	29
				XMLP025BD71F	29
				XMLP025BD270	29
				XMLP025BD290	29
				XMLP025BD770	29
				XMLP025BD790	29
				XMLP030RC23F	33
				XMLP030RC73F	33
				XMLP030RD23F	33
				XMLP030RD73F	33
				XMLP030RP23F	33
				XMLP030RP73F	33
				XMLP040BC11F	29
				XMLP040BC21F	29
				XMLP040BC71F	29
				XMLP040BC270	29
				XMLP040BC290	29
				XMLP040BD11F	29
				XMLP040BD21F	29
				XMLP040BD71F	29
				XMLP040BD190	29
				XMLP040BD270	29
				XMLP040BD290	29
				XMLP040BD790	29
				XMLP050RC23F	33
				XMLP050RD23F	33
				XMLP050RD73F	33
				XMLP050RP23F	33
				XMLP060BC11F	30
				XMLP060BC21F	30
				XMLP060BC71F	30
				XMLP060BC290	30
				XMLP060BD11F	30
				XMLP060BD21F	30
				XMLP060BD270	30
				XMLP060BD290	30
				XMLP060BD790	30
				XMLP100BC11F	30
				XMLP100BC21F	30
				XMLP100BC71F	30
				XMLP100BD11F	30
				XMLP100BD21F	30
				XMLP100BD71F	30
				XMLP100PD130	34
				XMLP100PD230	34
				XMLP100PD730	34
				XMLP100PP130	34
				XMLP100PP230	34
				XMLP100PP730	34
				XMLP100RD23F	33
				XMLP100RD73F	33
				XMLP150PD130	34
				XMLP150PD230	34
				XMLP150PD730	34
				XMLP150PP230	34
				XMLP150PP730	34
				XMLP160BC21F	31
				XMLP160BC71F	31
				XMLP160BD11F	31
				XMLP160BD21F	31
				XMLP160BD71F	31
				XMLP200PD130	34
				XMLP200PD230	34
				XMLP200PD730	34
				XMLP200PP230	34
				XMLP200PP730	34
				XMLP250BC11F	31
				XMLP250BC21F	31
				XMLP250BC71F	31
				XMLP250BD11F	31
				XMLP250BD21F	31
				XMLP250BD71F	31
				XMLP250MC11F	26
				XMLP250MC21F	26
				XMLP250MC71F	26
				XMLP250MD11F	26
				XMLP250MD21F	26
				XMLP250MD71F	26
				XMLP300PD130	35
				XMLP300PD230	35
				XMLP300PD730	35
				XMLP300PP130	35
				XMLP300PP230	35
				XMLP300PP730	35
				XMLP400BC11F	31
				XMLP400BC21F	31
				XMLP400BC71F	31
				XMLP400BD11F	31
				XMLP400BD21F	31
				XMLP400BD71F	31
				XMLP500MC11F	26
				XMLP500MC21F	26
				XMLP500MC71F	26
				XMLP500MD11F	26
				XMLP500MD21F	26
				XMLP500MD71F	26
				XMLP600BC21F	31
				XMLP600BC71F	31
				XMLP600BD11F	31

XMLP600BD21F	31	XMLR2D5G0T25	49	XMLR040G1P75	51	XMLR600M2P05	52	XZCP1241L10	17
XMLP600BD71F	31	XMLR2D5G0T75	49	XMLR040G2N05	51	XMLRM01G0T25	49		21
XMLP600PD130	35	XMLR2D5G1N25	49	XMLR040G2N06	51	XMLRM01G0T26	49		37
XMLP600PD230	35	XMLR2D5G1N26	49	XMLR040G2N25	51	XMLRM01G0T75	49		43
XMLP600PD730	35	XMLR2D5G1N75	49	XMLR040G2P05	51	XMLRM01G1N25	49		45
XMLP600PP130	35	XMLR2D5G1P25	49	XMLR040G2P06	51	XMLRM01G1N26	49	XZCP1241L15	45
XMLP600PP230	35	XMLR2D5G1P26	49	XMLR040G2P25	51	XMLRM01G1N75	49	XZCP1241L20	45
XMLP600PP730	35	XMLR2D5G1P75	49	XMLR100M0T25	51	XMLRM01G1P25	49	XZCPV11V12L2	53
XMLPM00GC2BF	24	XMLR2D5G2N05	49	XMLR100M0T26	51	XMLRM01G1P26	49	XZCPV11V12L5	53
XMLPM00GC7BF	24	XMLR2D5G2N06	49	XMLR100M0T75	51	XMLRM01G1P75	49	XZCPV11V12L10	53
XMLPM00GC11F	24	XMLR2D5G2P05	49	XMLR100M1N25	51	XMLRM01G2N05	49	XZCPV12V12L2	53
XMLPM00GC21F	24	XMLR2D5G2P06	49	XMLR100M1N26	51	XMLRM01G2N06	49	XZCPV12V12L5	53
XMLPM00GC71F	24	XMLR010G0T25	50	XMLR100M1N75	51	XMLRM01G2N25	49	XZCPV12V12L10	53
XMLPM00GD2BF	24	XMLR010G0T26	50	XMLR100M1P25	51	XMLRM01G2N26	49	XZCPV1141L2	37
XMLPM00GD7BF	24	XMLR010G0T75	50	XMLR100M1P26	51	XMLRM01G2P05	49		43
XMLPM00GD11F	24	XMLR010G0T76	50	XMLR100M1P75	51	XMLRM01G2P06	49	XZCPV1141L5	37
XMLPM00GD21F	24	XMLR010G1N25	50	XMLR100M2N05	51	XMLRM01G2P25	49		43
XMLPM00GD71F	24	XMLR010G1N26	50	XMLR100M2N06	51	XMLRM01G2P26	49	XZCPV1141L10	37
XMLPM00GL21F	24	XMLR010G1N75	50	XMLR100M2P05	51	XMLZL009	53		43
XMLPM00GL71F	24	XMLR010G1N76	50	XMLR100M2P06	51	XMLZL016	37	XZCPV1241L2	37
XMLPM00RC13F	32	XMLR010G1P25	50	XMLR160M0T25	51	XMLZL017	37		43
XMLPM00RC23F	32	XMLR010G1P26	50	XMLR160M0T75	51		43	XZCPV1241L5	37
XMLPM00RC73F	32	XMLR010G1P75	50	XMLR160M1N25	51		53		43
XMLPM00RD13F	32	XMLR010G1P76	50	XMLR160M1N75	51	XZCC12FCM40B	17	XZCPV1241L10	37
XMLPM00RD23F	32	XMLR010G2N05	50	XMLR160M1P25	51		21		43
XMLPM00RD73F	32	XMLR010G2N06	50	XMLR160M1P75	51		37	XZCR1511040A1	45
XMLPM00RP13F	32	XMLR010G2N09	50	XMLR160M2N05	51		45	XZCR1511040A2	45
XMLPM00RP23F	32	XMLR010G2N25	50	XMLR160M2N09	51		53	XZCR1511041C1	53
XMLPM00RP73F	32	XMLR010G2N26	50	XMLR160M2P05	51	XZCC12FCM50B	53	XZCR1511041C2	53
XMLPM01GC21F	24	XMLR010G2P05	50	XMLR160M2P09	51	XZCC12FDM40B	17	XZCR1511064D1	53
XMLPM01GC71F	24	XMLR010G2P06	50	XMLR250M0T25	52		21	XZCR1511064D2	53
XMLPM01GD21F	24	XMLR010G2P09	50	XMLR250M0T26	52		37	XZCR1512040A1	45
XMLPM01GD71F	24	XMLR010G2P25	50	XMLR250M0T75	52		43	XZCR1512040A2	45
XMLPM05GC21F	24	XMLR010G2P26	50	XMLR250M1N25	52		45	XZCR1512041C1	53
XMLPM05GC71F	24	XMLR016G0T25	50	XMLR250M1N26	52	XZCC12FDM50B	53	XZCR1512041C2	53
XMLPM05GD21F	24	XMLR016G0T26	50	XMLR250M1N75	52	XZCC12MCM40B	45	XZCR1512064D1	53
XMLPM05GD71F	24	XMLR016G0T75	50	XMLR250M1P25	52	XZCC12MDM40B	45	XZCR1512064D2	53
XMLPM09BC21F	25	XMLR016G1N25	50	XMLR250M1P26	52	XZCC43FCP40B	17		
XMLPM09BC71F	25	XMLR016G1N26	50	XMLR250M1P75	52		37		
XMLPM09BD11F	25	XMLR016G1P25	50	XMLR250M1P76	52	XZCP1141L2	17	Z	
XMLPM09BD21F	25	XMLR016G1P26	50	XMLR250M2N05	52		21	ZMLPA1N2SH	37
XMLPM09BD71F	25	XMLR016G1P75	50	XMLR250M2N06	52		37		43
XMLPM15RC23F	32	XMLR016G2N06	50	XMLR250M2N09	52		43	ZMLPA1N2SW	37
XMLPM15RD23F	32	XMLR016G2P05	50	XMLR250M2N25	52		45		43
XMLPM15RD73F	32	XMLR016G2P06	50	XMLR250M2N26	52		53		45
XMLPM15RP23F	32	XMLR016G2P25	50	XMLR250M2P05	52	XZCP1141L5	17	ZMLPA1P2SH	37
XMLPM25BD21F	25	XMLR025G0T25	50	XMLR250M2P06	52		21		43
XMLPM60RC23F	32	XMLR025G0T26	50	XMLR250M2P09	52		37	ZMLPA1P2SW	37
XMLPM60RD23F	32	XMLR025G0T75	50	XMLR250M2P25	52		43		43
XMLPM60RD73F	32	XMLR025G1N25	50	XMLR250M2P26	52		45		45
XMLPM60RP23F	32	XMLR025G1N26	50	XMLR400M0T25	52	XZCP1141L10	17	ZMLPA2N0SH	37
XMLPZLH01	45	XMLR025G1N75	50	XMLR400M0T26	52		21		43
XMLPZLV01	45	XMLR025G1P25	50	XMLR400M0T75	52		37		45
XMLR001G0T25	49	XMLR025G1P26	50	XMLR400M1N25	52		43	ZMLPA2P0SH	37
XMLR001G0T26	49	XMLR025G1P75	50	XMLR400M1N26	52		45		43
XMLR001G0T75	49	XMLR025G2N05	50	XMLR400M1N75	52	XZCP1141L15	45		45
XMLR001G0T76	49	XMLR025G2N06	50	XMLR400M1P25	52	XZCP1141L20	45		
XMLR001G1N25	49	XMLR025G2N06	50	XMLR400M1P26	52	XZCP1241L2	17		
XMLR001G1N26	49	XMLR025G2P05	50	XMLR400M1P75	52		21		
XMLR001G1N75	49	XMLR025G2P06	50	XMLR400M2N05	52		37		
XMLR001G1P25	49	XMLR040G0T25	51	XMLR400M2N06	52		43		
XMLR001G1P26	49	XMLR040G0T26	51	XMLR400M2N25	52		45		
XMLR001G1P75	49	XMLR040G0T75	51	XMLR400M2N26	52		53		
XMLR001G2N05	49	XMLR040G1N25	51	XMLR400M2P05	52	XZCP1141L5	17		
XMLR001G2N06	49	XMLR040G1N26	51	XMLR400M2P06	52		21		
XMLR001G2P05	49	XMLR040G1N75	51	XMLR400M2P25	52		37		
XMLR001G2P06	49	XMLR040G1P25	51	XMLR400M2P26	52		43		
		XMLR040G1P26	51	XMLR400M2P75	52		45		
				XMLR600M0T25	52		53		
				XMLR600M0T75	52				
				XMLR600M1P25	52				
				XMLR600M1P75	52				

Schneider Electric Industries SAS

Head Office
35, rue Joseph Monier
F-92500 Rueil-Malmaison
France

www.tesensors.com

The information provided in this documentation contains general descriptions and/or technical characteristics of the performance of the products contained herein. This documentation is not intended as a substitute for and is not to be used for determining suitability or reliability of these products for specific user applications. It is the duty of any such user or integrator to perform the appropriate and complete risk analysis, evaluation and testing of the products with respect to the relevant specific application or use thereof. Neither Schneider Electric nor any of its affiliates or subsidiaries shall be responsible or liable for misuse of the information contained herein.

Design: Schneider Electric
Photos: Schneider Electric

July 2017 - V5.0

DIA4ED2150102EN