

TR-72D

RF Transceiver Module Series

Data Sheet



Smarter Wireless. Simply.

Description

TR-72D is a family of IQRF transceiver modules operating in the 868 MHz and 916 MHz license free ISM (Industry, Scientific and Medical) frequency band. Its highly integrated ready-to-use design containing MCU, RF circuitry, integrated LDO regulator, serial EEPROM, optional temperature sensor and optional on-board antenna requires no external components. Extended RF power results in higher RF range. Ultra low power consumption fits for battery powered applications. MCU with built-in operating system significantly reduces application development time. Optional DPA framework supports applications even without programming.



There is no difference between TR and DCTR transceiver versions from IQRF OS v4.02D. All TRs support both OS as well as DPA approaches.

Key features

- Operating system (upgradeable at the user), easy to use
- DPA framework for Data controlled approach (formerly DCTR)
- GFSK modulation
- Selectable RF band 868 / 916 MHz, multiple channel
- RF output power 10 mW
- MCU with extended resources, user interrupt capability
- Extra low power consumption, power management modes
- SPI interface supported by OS in background
- Serial EEPROM 256 Kb
- PWM output
- Programmable HW timer
- +3 V LDO regulator output, battery monitoring
- 2 LEDs
- 8 pins, 6 I/Os
- A/D converter (2 channels), analog comparator
- Options: on-board antenna, U.FL connector, temperature sensor
- SIM card format fits KON-SIM-02 and KON-SIM-01 connectors
- Shielding can

Applications

- Bidirectional RF communication
- Point-to-point or network wireless connectivity
- Telemetry, AMR (automatic meter reading)
- WSN (wireless sensor network)
- Building automation
- Street lighting control
- Wireless monitoring, control and regulation
- Remote data acquisition
- RF connectivity in many other fields
- Also for municipal and indoor areas
- Internet of Things

Block diagram

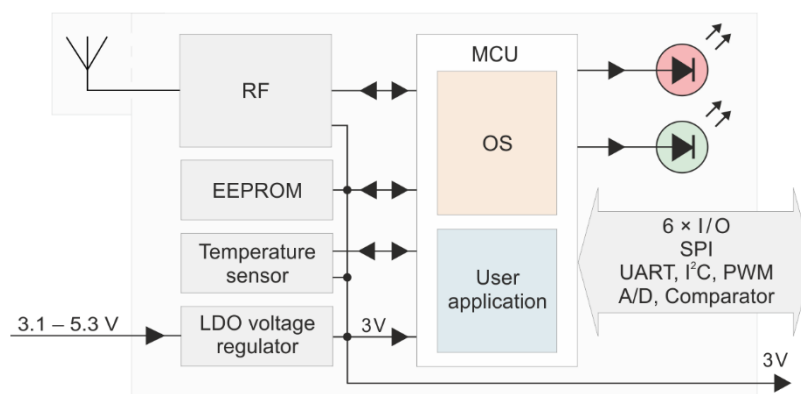

The information contained in this publication regarding device applications and the like is provided only for your convenience and may be superseded by updates. It is your responsibility to ensure that your application meets your specifications.

IQRF Tech MAKES NO REPRESENTATIONS OR WARRANTIES OF ANY KIND TO STATED CONDITION, QUALITY, PERFORMANCE, MERCHANTABILITY OR FITNESS FOR PURPOSE and disclaims all liability arising from this information and its use. Use of IQRF Tech devices in life support and/or safety applications is entirely at the buyer's risk, and the buyer agrees to defend, indemnify and hold harmless IQRF Tech from any and all damages, claims, suits, or expenses resulting from such use. No licenses are conveyed, implicitly or otherwise, under any IQRF Tech intellectual property rights.

Electrical specifications

Typical values unless otherwise stated

Parameters specified in this datasheet are typical values. They are at power supply $V_{OUT} = 3\text{ V}$ only. V_{OUT} voltage different from 3 V can impact on RF range and other parameters.

Supply voltage (V_{CC})	3.1 V to 5.3 V
LDO output (V_{OUT})	+3 V \pm 60 mV ($V_{CC} > 3.1\text{ V}$), 100 mA max.
Operating temperature ¹	-40 °C to +85 °C
Supply current	
Deep sleep mode (OS v4.00 or higher only)	1.7 μ A (all peripherals disabled ³ , RF IC in Standby mode)
Sleep mode	2.3 μ A (all peripherals disabled ³ , RF IC in Sleep mode)
Run mode	
RF sleep	1.4 mA
RF ready	2.8 mA
RX mode	
STD	12.1 mA
LP ⁴	260 μ A
XLP ⁴	18.5 μ A
TX mode	8.3 mA – 25 mA (according to RF output power)
Additional LED supply current	About 2 mA per LED. Rough value for brief guidance only.
RF band	868 MHz or 916 MHz (software configurable)
RF channels	See IQRF OS User's guide, Appendix <i>Channel maps</i>
RF data modulation	GFSK (Gaussian Frequency Shift Keying)
RF data transmission bit rate ⁵	19.8 kb/s
RF receiver category	1.5 (according to ETSI EN 300 220-1 V3.1.1)
RF sensitivity ⁶	-101 dBm, (STD RX mode, <code>checkRF(0)</code>). See <i>Diagram 4</i> .
RF output power ^{6,7A}	Up to 10 dBm (for 50 Ω load), programmable in 8 levels (0 – 7).
Effective radiated power ^{7B}	Up to 6.5 dBm ^{2A} , 11 dBm ^{2B} (868 MHz band), 2.0 to 6.5 dBm ^{2A} (916 MHz band). See <i>Diagrams 2A, 2B</i> .
RF interface ^{7A}	Single-ended, output impedance 50 Ω
Antenna ^{7B}	PCB meander line, linear polarization, omnidirectional. See <i>Diagram 1</i> .
RF range ^{2,7B}	500 m ^{2A} , 1100 m ^{2B}
Input voltage on C1, C2, C5 to C8 pins	0 V to V_{OUT}
A/D converter	10 bit, 2 inputs. Refer to MCU datasheet.
Temperature sensor	MCP9808E/MC (for TR types with 'T' postfix only, e.g. TR-72DT)
Size (L x W x H)	25.1 mm x 14.9 mm x 3.3 mm ^{7A} 31.8 mm x 14.9 mm x 3.3 mm ^{7B}

Note 1: RF range may change with lower temperature. Frost, condensation or humidity over 85% may disable module functionality. Transceiver suitability should be tested in the final application at real conditions before volume use.

Note 2: Arrangement: Two TR-72DA transceivers in DK-EVAL-04A kits, vertically, 1.6 m above the ground, in free space, bidirectional communication.

2A: TR-72DA transceivers plugged directly in DK-EVAL-04A kits.

2B: TR-72DA transceivers plugged in DK-EVAL-04A kits through the RNG-EXT-01 adapters.

Test software: E09-LINK example (STD mode, `setRFpower(7)`, `checkRF(0)`), bit rate 19.8 kb/s.

Note 3: Additional current is consumed when a peripheral (e.g. watchdog, Brown-out detection etc.) is enabled.

Note 4: Depends on interferences.

Note 5: Several RF bit rates different from 19.8 kb/s will be available in future IQRF OS versions.

Note 6: RF circuitry and RF balun included, built-in PCB antenna not included.

Note 7: **7A:** For TR types without built-in antenna.

7B: For TR types with built-in antenna.

Pin	Name	Description
C1	IO/ADC/C-IN	
	RA0	General I/O pin
	AN0	Analog A/D input
	C12IN0	Comparator –input
C2	IO/VOUT	
	RC2	General I/O pin (when S1 disconnected)
	VOUT	On-board +3 V LDO output (when S1 connected)
C3	VIN	Power supply voltage
C4	GND	Ground
C5	IO/ADC/TX/-SS /PWM/COUT	
	RA5	General I/O pin,
	-SS	SPI Slave select
	AN4	Analog A/D input
	C2OUT	Comparator output
	RC6	General I/O pin
	TX	UART TX
	CCP3	PWM output
	RB4	General I/O pin, with programmable pull-up and interrupt/wake-up on change (IOC), RFPGM termination
	AN11	Analog A/D input
	C6	IO/SCK/SCL
	RC3	General I/O pin
	SCK	SPI clock input
	SCL	I ² C clock
C7 ¹	IO/SDI/SDA	
	RC4	General I/O pin. Used as input during initial about 200 ms boot-up (after power supply rising-up) to recognize programming mode.
	SDI	SPI data
	SDA	I ² C data
C8 ¹	IO/RX/SDO	
	RC5	General I/O pin. Used as output during initial about 200 ms boot-up (after power supply rising-up) to recognize programming mode.
	SDO	SPI data out
	RC7	General I/O pin
	RX	UART RX
X5	ANT	Antenna input
P1–P5		For manufacturer only
S1		LDO output enable. Interconnect both S1 pads to enable. Default (from the factory) disabled.
M1, M2		Holes for possible mechanical fixation

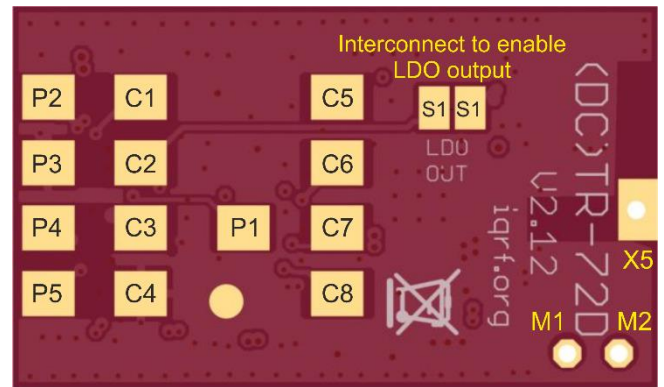

Bottom view

Note 1: Pin C8 is used as output and pin C7 as input during the initial approximately 200 ms boot-up (after power supply rising-up) to detect a possible request to enter the programming mode (PGM - wired upload via SPI). After reset, the OS generates a determinate sequence on the C8 pin. If this sequence is copied to the C7, the OS jumps to the PGM bootloader. (The PGM mode is indicated by short red LED flashing every 2 s.)

This must be taken into account to avoid collisions with application circuitry connected to these pins.

The C7 pin must not be interconnected to C8 or left unconnected or without a **defined level** on its input. This level must be arranged **by application hardware**. If the application circuitry ensures no such level, a **pull-down resistor on C7 pin** must be used otherwise a **cross-talk** between C8 and C7 may cause an unintentional switching to PGM.

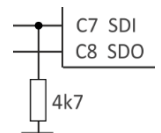

See the application note [AN015 - IQRF HW design for TR-7xD transceivers](#).

RF range

RF range strongly depends on the following design aspects:

- Hardware:
 - Construction of the devices (especially TR location within the device, PCB layout, ground planes, conductive areas and bulk objects such as metallic parts and batteries in the nearest surroundings, with respect to possible reflections and counterpoise effect). To achieve an efficient range and reliable connectivity, no parts impacting the range must be placed close to the built-in meander antenna. Even non-conductive parts including a mainboard PCB under the antenna can significantly impact the range.
 - Physical arrangement of devices (especially mutual orientations of antennas with respect to polarizations and radiation patterns)
- Application software:
 - RF output power is selectable from 8 levels
 - To increase immunity to RF noise, incoming RF signal can be filtered according to signal strength.

Refer to IQRF OS Reference guide, function `checkRF` and Application note AN014 *RF range optimizing at TR-7xDx transceivers*.

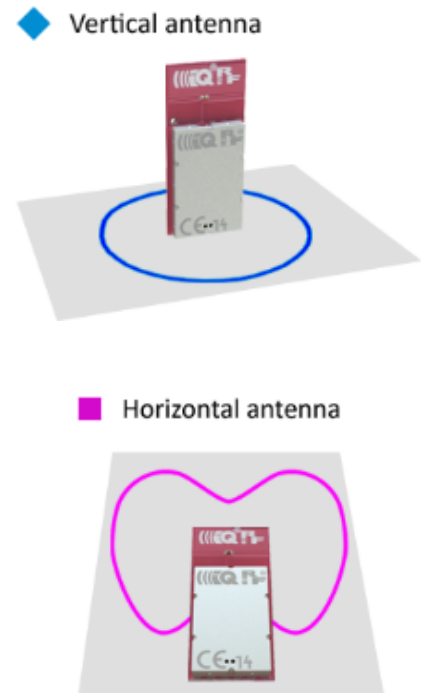
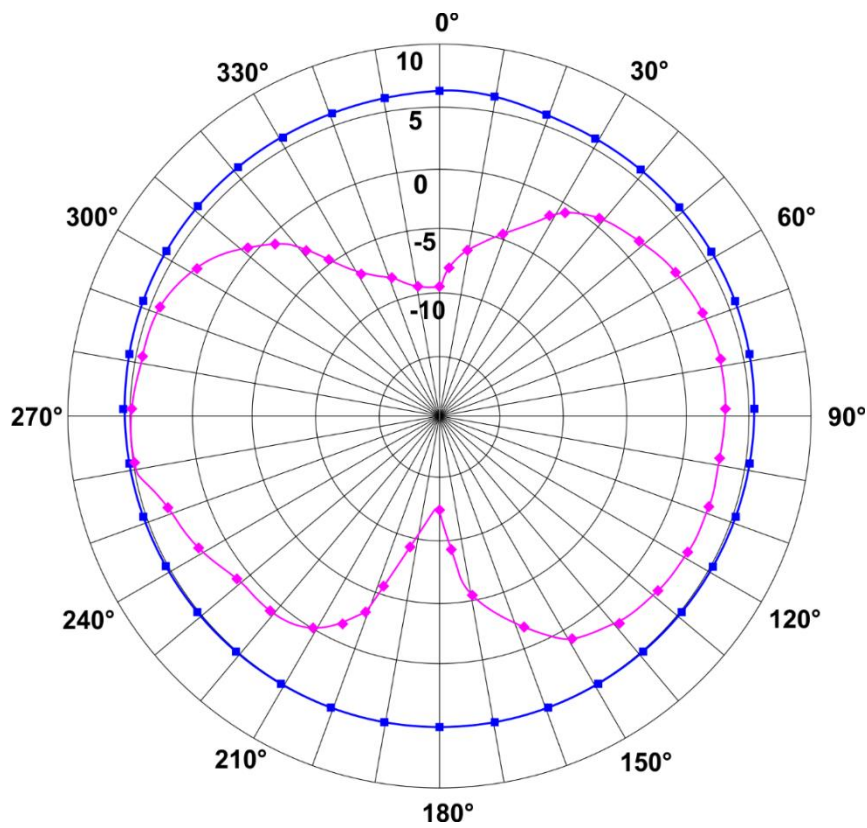
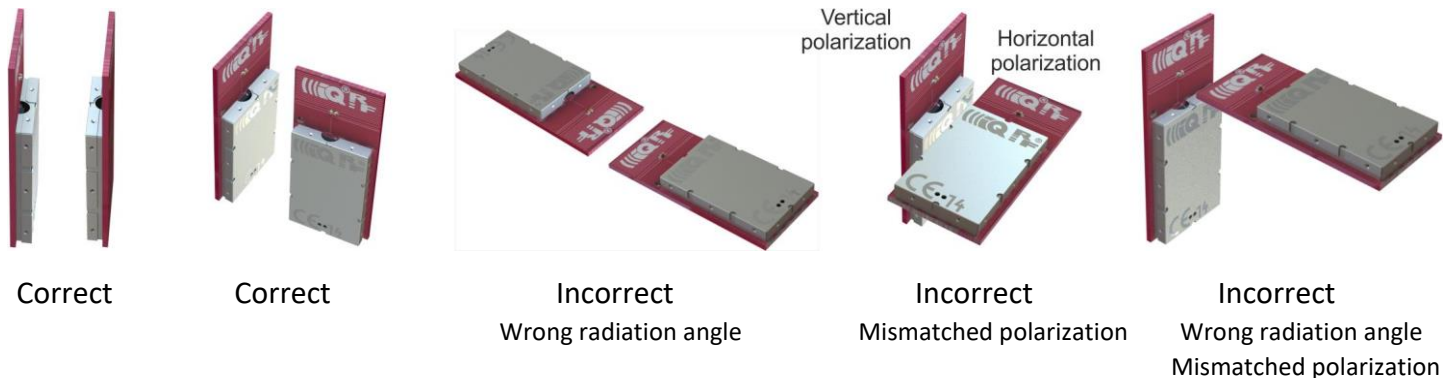

Diagram 1: TR-7xDA RF output power [in dBm] vs. antenna orientation (radiation patterns).

Examples of the correct and incorrect arrangement of TR-72DA pairs:



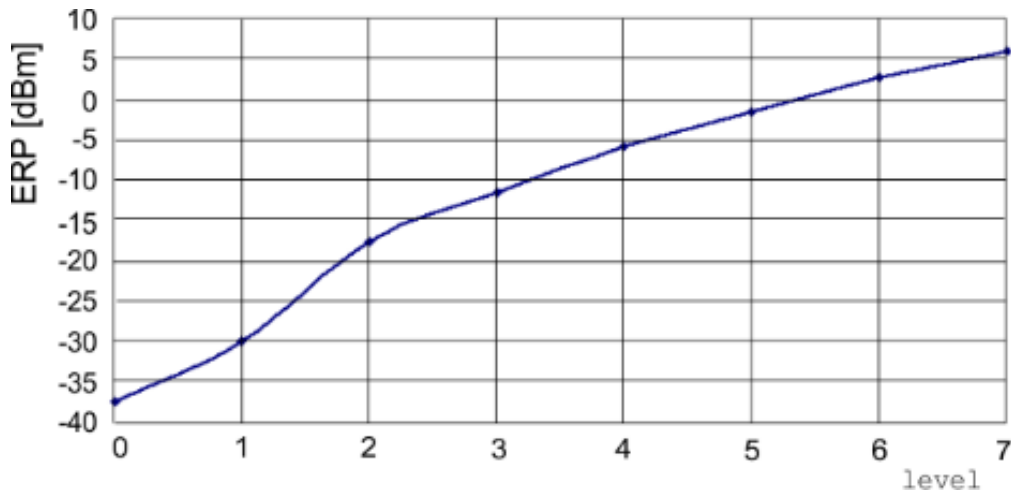

Diagram 2A: Effective radiated power (ERP) vs. level in the `setRFpower(level)` function. TR-72D(A), 868 MHz band, channels 0 to 67. Refer to IQRF OS Reference guide.

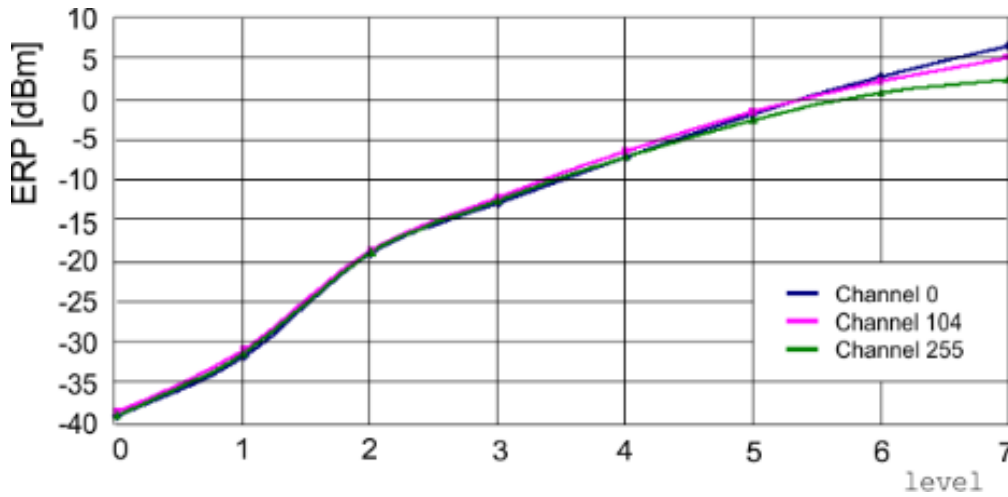

Diagram 2B: Effective radiated power (ERP) vs. level in the `setRFpower(level)` function. TR-72D(A), 916 MHz band. Refer to IQRF OS Reference guide.

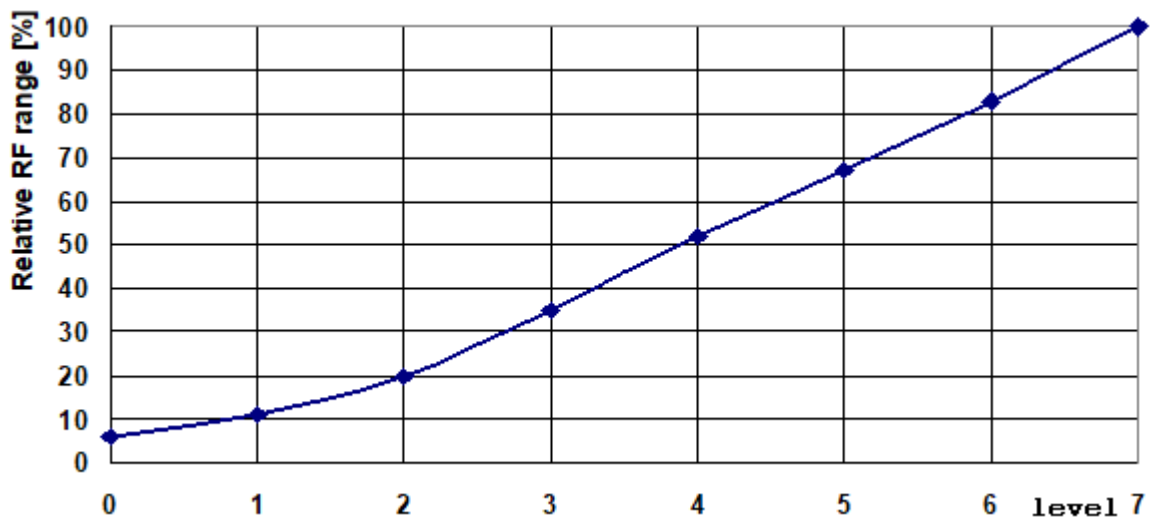

Diagram 2C: Relative RF range vs. level in the `setRFpower(level)` function. TR-72D(A), 868 MHz and 916 MHz bands. Refer to IQRF OS Reference guide.

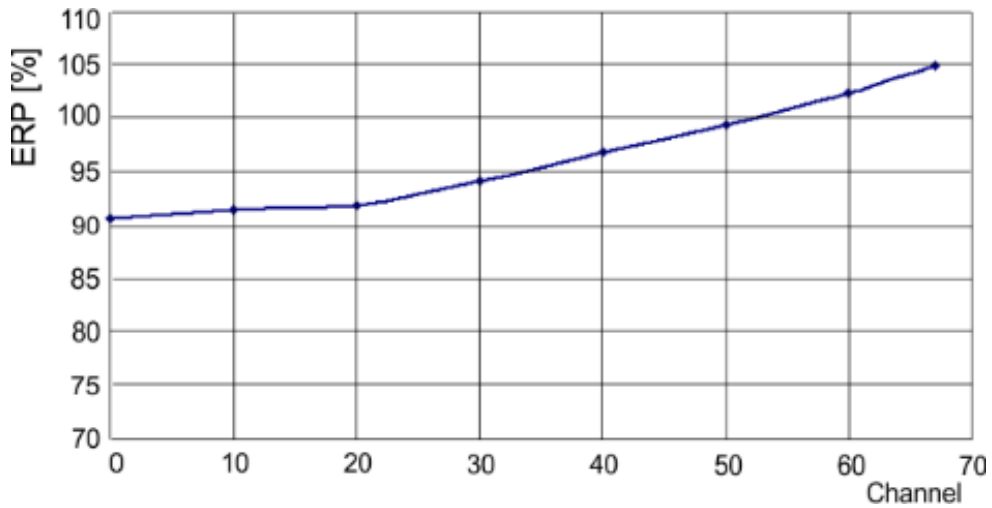

Diagram 3A: Relative effective radiated power (ERP) vs. channel, TR-72D(A), 868 MHz band, with respect to channel 52 (100 %).

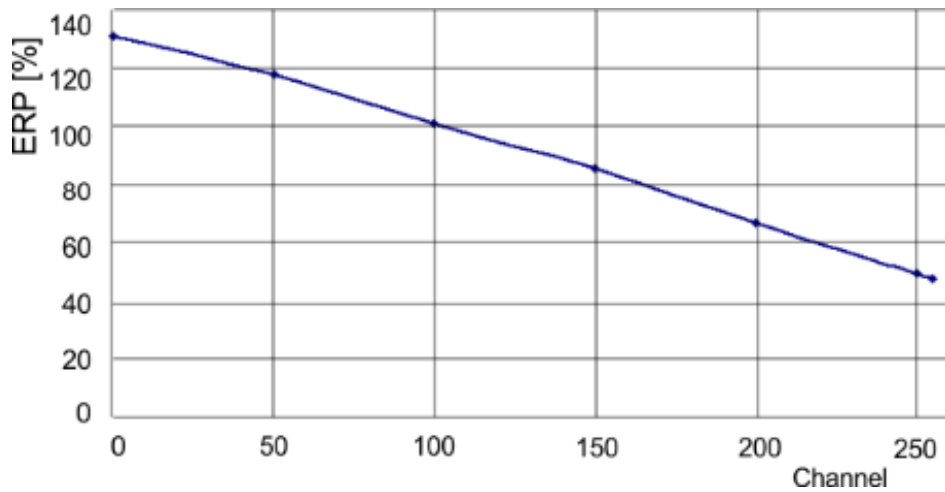

Diagram 3B: Relative effective radiated power (ERP) vs. channel, TR-72D(A), 916 MHz band, with respect to channel 104 (100 %).

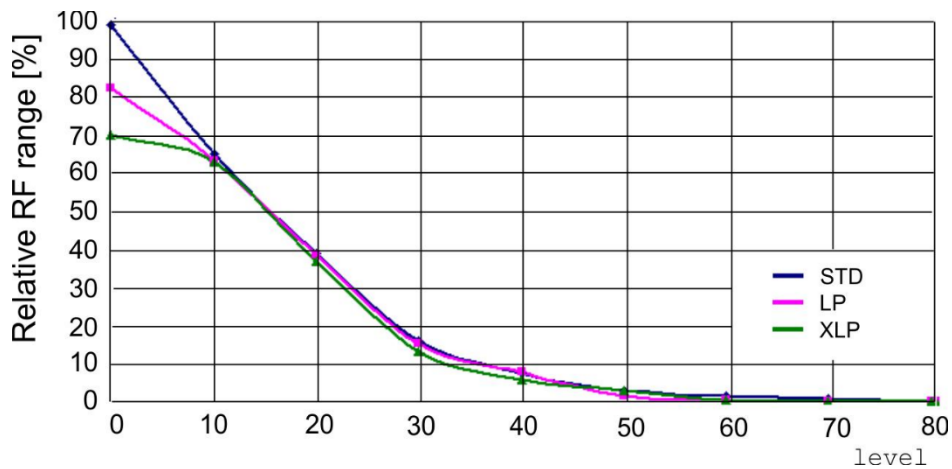

Diagram 4: Relative RF range vs. level in the `checkRF(level)` function in STD, LP and XLP RX modes. Refer to IQRF OS Reference guide, function `checkRF()`.

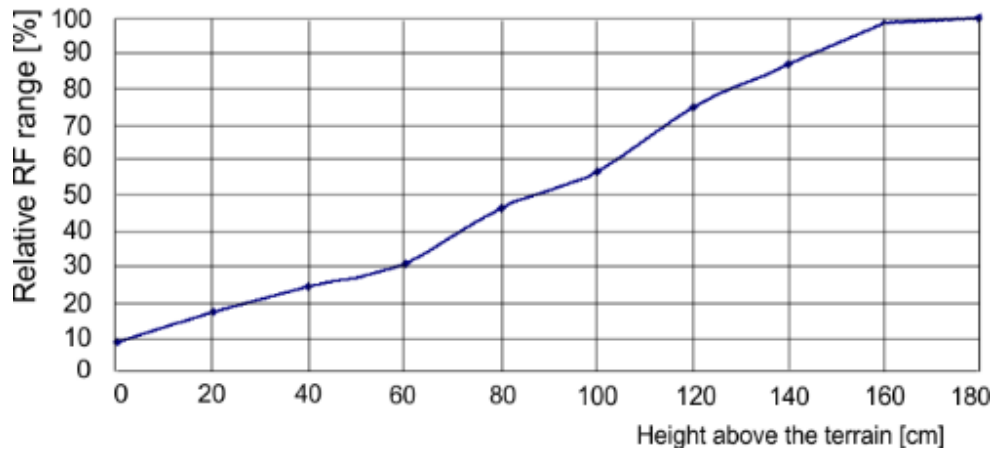
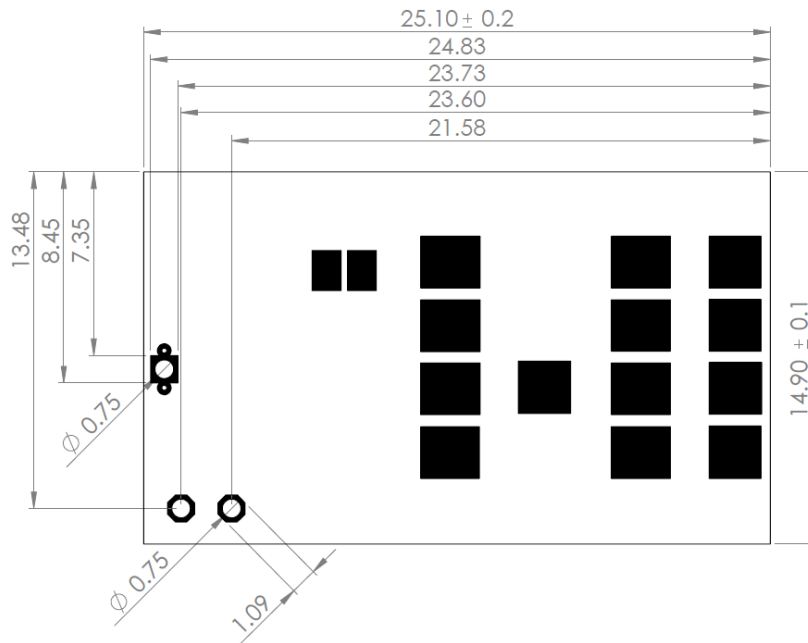

Diagram 5: TR-72DA relative RF range vs. antenna height above the ground, 868 MHz and 916 MHz bands.

Mechanical drawings

TR-72D(C)(T)



TR-72DA(T)

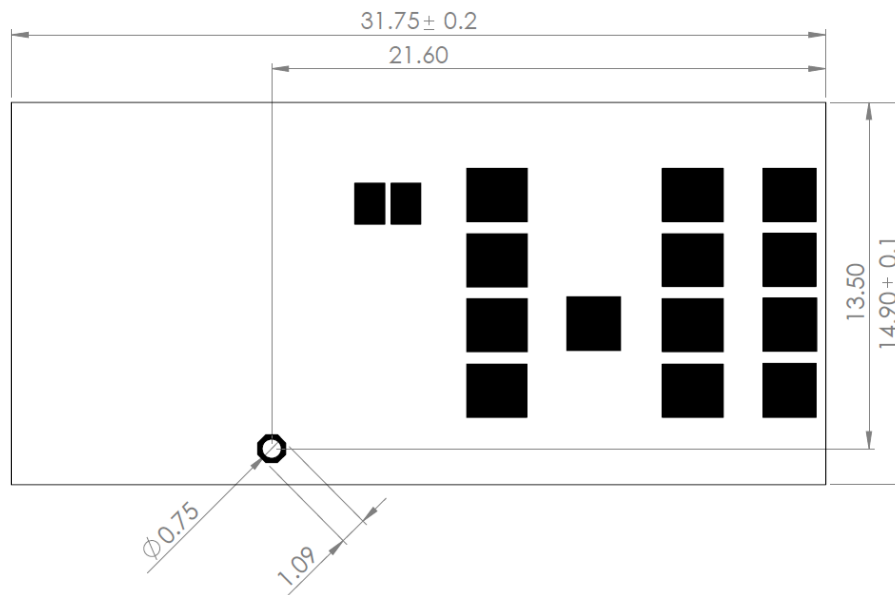

Top view, Units: mm

Hardware revision

- TR-72D(A) v2.16 Minor improvements to optimize production.
- TR-72DA v2.15 Minor improvements to optimize production.
- TR-72D(A) v2.14 Minor improvements to optimize production.
- TR-72DA v2.13 Minor improvements to optimize production.
- TR-72D(A) v2.12 Minor HW changes. TR-72DA parts suitable also for 916 MHz band are marked "868/916" by laser.
- TR-72DA v2.11 EAP samples, minor HW changes, 868 MHz only.
- TR-72D v2.10 EAP samples, standard dimensions, 868 MHz only.
- TR-72DA v2.02 EAP samples, length 33.8 mm, 868 MHz only.
- TR-72DA v2.01 EAP samples, limited RF range, 868 MHz only.

Application

Users have to ensure observing local provisions and restrictions relating to the use of short-range devices **by software**, e.g. the CEPT ERC/REC 70-03 Recommendation and subsequent amendments in EU.

See IQRF video tutorial set on www.iqrf.org/videos.

See the application note [AN015 - IQRF HW design for TR-7xD transceivers](#).

Assembly

TR-72Dx modules should be mounted in SIM connector. They are not intended for SMT reflow soldering. Recommended SIM connector: KON-SIM-02 or KON-SIM-01.

It is not allowed to connect wires to pads (except the M1, M2 and S1 pads) by soldering.

Sealing

In case of sealing or protecting TR modules against a harsh environment by coating, encapsulating or potting using a lacquer, gel or other filling matter, refer to the Application note *AN015 – IQRF HW design for TR-7xD transceivers*, chapter *Sealing*.

Operating system

See IQRF OS User's guide and IQRF OS Reference guide.

DPA framework and DCTR

See DPA Framework technical guide.

Application software

See IQRF Quick start guide and IQRF application examples.

Programming (upload)

There are the following possibilities to upload an application program in TR-72Dx modules:

- Wired upload with TR-72Dx plugged via the SIM connector in the CK-USB-04(A) programmer.
- For TR-72Dx modules populated in an application:
 - Wired upload
 - Using the CK-USB-04A programmer. See the CK-USB-04A User's guide.
 - Using the CK-USB-04 programmer and the KON-TR-01P adapter. See the KON-TR-01P User's guide.
 - Completely arranged by user application. See the *IQRF SPI Technical guide*, chapter *Programming mode*.
 - Wireless upload: See the IQRF OS User's guide, Appendix *RFPGM – RF programming™*.

Product information

Ordering codes

TR-72D A P

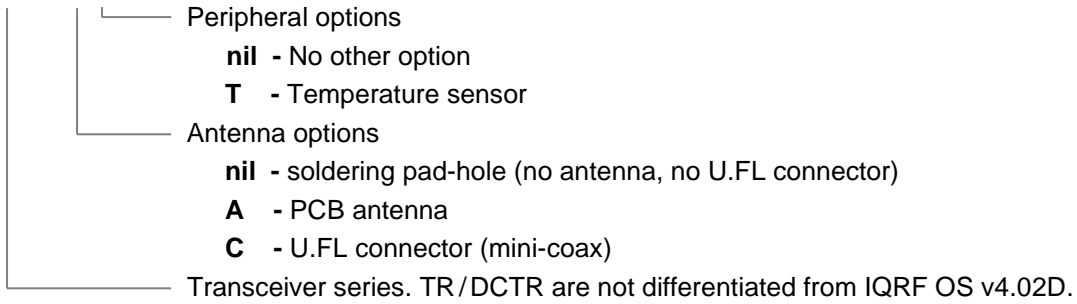

Type	Antenna connection	Data controlled	Temperature sensor
TR-72D	Soldering pad-hole	Yes	–
TR-72DC	U.FL connector	Yes	–
TR-72DA	PCB antenna	Yes	–

Type	Antenna connection	Data controlled	Temperature sensor
TR-72DT	Soldering pad-hole	Yes	Yes
TR-72DCT	U.FL connector	Yes	Yes
TR-72DAT	PCB antenna	Yes	Yes

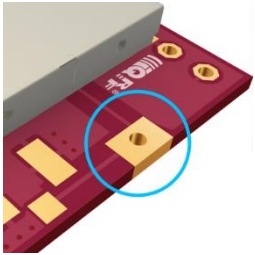

TR-72D

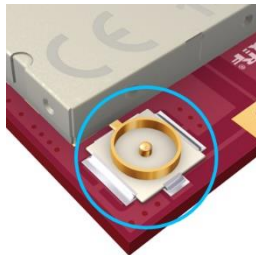

TR-72DC



TR-72DA

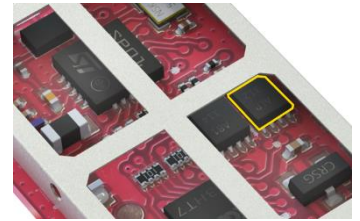

TR-72DT

Document history

- 200525 References to application note *AN015 – IQRF HW design for TR-7xD transceivers* added.
- 191209 *Note 1* added to Pin description table. Paragraph *Programming (upload)* in chapter *Application* slightly extended. Chapter *Sealing* relocated into Application note *AN015 – IQRF HW design*, chapter *Sealing*.
- 191010 Supply current in TX mode in *Electrical specifications* modified. Updated for TR-72D v2.16.
- 190626 Updated for TR-72DA v2.16.
- 180627 *Diagram 2C* added. TR-72DA HW v2.15 added to chapter *Hardware revision*.
- 180130 Block diagram revised. RF parameters in chapter *Electrical specifications* revised. HW revisions updated. Chapter *RF range* extended. Directives in *Quality management* updated.
- 171108 Pins description page slightly precised regarding mechanical holes M1 and M2. Legend at Diagrams 2A, 2B, 3A and 3B slightly precised.
- 170823 Updated for IQRF OS v4.02D.
- 170810 Updated for TR/DCTR fusion from IQRF OS v4.01D. Mechanical drawings and Recommended PCB layout updated. TR size rounded to 25.1 mm in chapter *Electrical specifications*. *Diagram 4* updated. Some minor improvements.
- 170322 Diagrams 3A and 3B added. Preliminary.
- 170314 Updated for HW v2.14 and IQRF OS v4.00 (preliminary). *Electrical specification* revised. Chapter *Sealing* added. Chapter *RF range* revised. Variances in mechanical drawings slightly precised. Some minor improvements.
- 160302 Notice of local provisions added to chapter *Application*.
- 160219 More detailed RF range specification. C7 and C8 pin description extended.
- 151005 ETSI directives updated.
- 150810 Revised. Preliminary.
- 140430 Preliminary.

Sales and Service

Corporate office

IQRF Tech s.r.o., Prumyslova 1275, 506 01 Jicin, Czech Republic, EU
Tel: +420 493 538 125, Fax: +420 493 538 126, www.iqrf.tech
E-mail (commercial matters): sales@iqrf.org

Technology and development

www.iqrf.org
E-mail (technical matters): support@iqrf.org

Partners and distribution

www.iqrf.org/partners

Quality management

ISO 9001 : 2009 certified

Complies with ETSI directives EN 301 489-1 V1.9.2:2011, EN 301 489-3 V1.6.1:2013, EN 300 220-1 V3.1.1:2017, EN 300 220-2 V3.2.0:2017 and ERC Recommendation 70-03 (2017) and VO-R/10/05.2014-3.

Complies with directives 2011/65/EU (RoHS) and 2012/19/EU (WEEE).



Trademarks

*The IQRF name and logo are registered trademarks of IQRF Tech s.r.o.
PIC, SPI, Microchip and all other trademarks mentioned herein are a property of their respective owners.*

Legal

All information contained in this publication is intended through suggestion only and may be superseded by updates without prior notice. No representation or warranty is given and no liability is assumed by IQRF Tech s.r.o. with respect to the accuracy or use of such information.

Without written permission, it is not allowed to copy or reproduce this information, even partially.

No licenses are conveyed, implicitly or otherwise, under any intellectual property rights.

The IQRF® products utilize several patents (CZ, EU, US).

On-line support: support@iqrf.org



Smarter Wireless. Simply.