

16 A 800 V high temperature SCR thyristor in TO-220AB insulated package

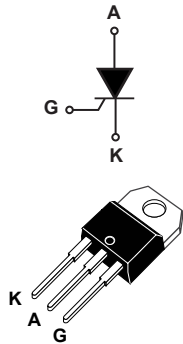

TO-220AB insulated

Features

- High junction temperature: $T_{jmax.} = 150\text{ °C}$
- $V_{DRM} / V_{RRM} = 800\text{ V}$
- $V_{DSM} / V_{RSM} = 900\text{ V}$
- Tight I_{GT} spread: 5 to 8 mA
- High static immunity $dV/dt = 500\text{ V}/\mu\text{s}$ at 150 °C
- High turn-on rise dI/dt at $100\text{ A}/\mu\text{s}$
- Halogen-free molding, lead-free plating
- Insulated package TO-220AB:
 - Insulated voltage: 2500 V_{RMS}
 - Complies with UL 1557 (File ref : E81734)
- ECOPACK2 compliant

Applications

- Inrush current limiting circuits in AC/DC converters
- General purpose AC line load switching
- Heating resistor control, solid state relays
- Crowbar and power bus discharge circuits

Description

Thanks to its operating junction temperature up to 150 °C , the TN1605H-8I offers high thermal performance operation up to 16 A rms in a TO-220AB insulated package.

Its trade-off noise immunity ($dV/dt = 500\text{ V}/\mu\text{s}$) versus its gate triggering current (maximum $I_{GT} = 8\text{ mA}$) and its turn-on current rise ($dI/dt = 100\text{ A}/\mu\text{s}$) allows to design robust and compact control circuit in AC/DC converters for inrush current limiting circuits and industrial drives, such as overvoltage crowbar protection, motor control circuits and power tools.

Product status

TN1605H-8I

Product summary

Order code	TN1605H-8I
Package	TO-220AB ins.
$I_{T(RMS)}$	16 A
V_{DRM}/V_{RRM}	800 V
$T_j\text{ max.}$	150 °C

1 Characteristics

Table 1. Absolute maximum ratings (limiting values)

Symbol	Parameter	Value	Unit
$I_{T(RMS)}$	RMS on-state current (180° conduction angle)	$T_C = 118\text{ °C}$ 16	A
$I_{T(AV)}$	Average on-state current (180 ° conduction angle)	$T_C = 118\text{ °C}$ 10	A
		$T_C = 127\text{ °C}$ 8	
		$T_C = 135\text{ °C}$ 6	
I_{TSM}	Non repetitive surge peak on-state current (T_J initial = 25 °C)	$t_p = 8.3\text{ ms}$ 177	A
		$t_p = 10\text{ ms}$ 160	
I^2t	I^2t value for fusing	$t_p = 10\text{ ms}$ 128	A ² s
V_{DRM}, V_{RRM}	Repetitive peak off-state voltage	800	V
V_{DSM}, V_{RSM}	Non repetitive peak off-state voltage	$t_p = 10\text{ ms}$ $V_{DRM} / V_{RRM} + 100\text{ V}$	V
di/dt	Critical rate of rise of on-state current $I_G = 2 \times I_{GT}, t_r < 100\text{ ns}$	$f = 60\text{ Hz}$ 100	A/ μ s
I_{GM}	Peak gate current	$t_p = 20\text{ }\mu$ s $T_J = 150\text{ °C}$ 4	A
$P_{G(AV)}$	Average peak gate power dissipation	$T_J = 150\text{ °C}$ 1	W
V_{RGM}	Maximum peak reverse gate voltage	5	V
T_{stg}	Storage junction temperature range	-40 to +150	°C
T_J	Operating junction temperature range	-40 to +150	
T_l	Maximum lead temperature soldering during 10 s	260	
V_{ins}	RMS insulation voltage during 1 min.	2500	

Table 2. Electrical characteristics ($T_J = 25\text{ °C}$ unless otherwise specified)

Symbol	Test conditions	Value	Unit
I_{GT}	$V_D = 12\text{ V}, R_L = 33\text{ }\Omega$	Min.	5
		Max.	8
V_{GT}		Max.	1.3
V_{GD}	$V_D = V_{DRM}, R_L = 3.3\text{ k}\Omega$	$T_J = 150\text{ °C}$ Min.	0.2
I_H	$I_T = 500\text{ mA}$, gate open	Max.	30
I_L	$I_G = 1.2 \times I_{GT}\text{ max.}$	Max.	40
dV/dt	$V_{OUT} = 536\text{ V}$, gate open	$T_J = 150\text{ °C}$ Min.	500
t_{gt}	$I_T = 32\text{ A}, V_D = 536\text{ V}, I_G = 12\text{ mA}, (di_G/dt)\text{ max} = 0.2\text{ A}/\mu$ s	Typ.	1.9
t_q	$I_T = 32\text{ A}, V_D = 536\text{ V}, V_R = 25\text{ V}, dV_D/dt = 40\text{ V}/\mu$ s	$T_J = 25\text{ °C}$ Typ.	25
		$T_J = 150\text{ °C}$ Typ.	85

Table 3. Static characteristics

Symbol	Test conditions			Value	Unit
V_{TM}	$I_{TM} = 32 \text{ A}$, $t_p = 380 \mu\text{s}$	$T_j = 25 \text{ }^\circ\text{C}$	Max.	1.55	V
V_{TO}	Threshold voltage	$T_j = 150 \text{ }^\circ\text{C}$	Max.	0.82	
R_D	Dynamic resistance	$T_j = 150 \text{ }^\circ\text{C}$	Max.	25	m Ω
I_{DRM} , I_{RRM}	$V_D = V_{DRM}$; $V_R = V_{RRM}$	$T_j = 25 \text{ }^\circ\text{C}$	Max.	1	μA
		$T_j = 150 \text{ }^\circ\text{C}$		3.5	mA

Table 4. Thermal parameters

Symbol	Parameter		Value	Unit
$R_{th(j-c)}$	Junction to case (DC)	Max.	2.2	$^\circ\text{C/W}$
$R_{th(j-a)}$	Junction to ambient	Typ.	60	

1.1 Characteristics curves

Figure 1. Maximum average power dissipation versus average on-state current

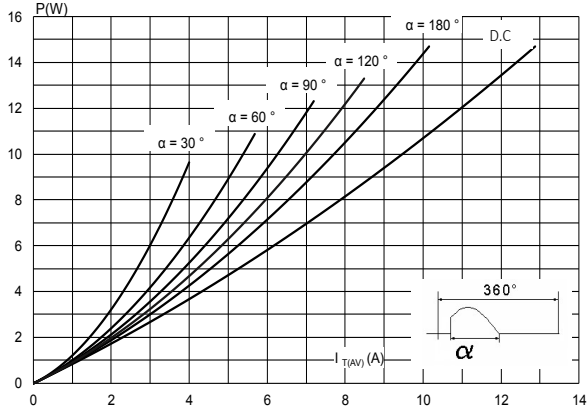

Figure 2. Average and DC on-state current versus case temperature

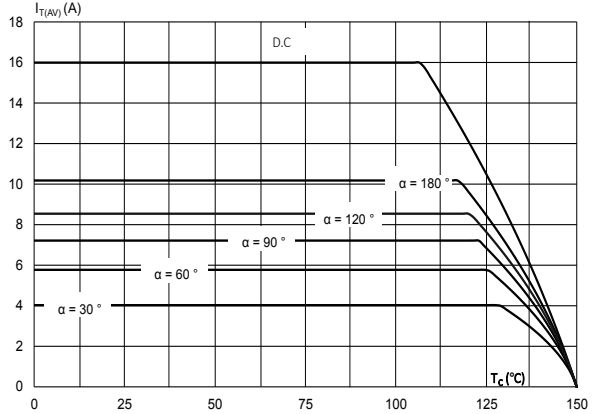

Figure 3. Average and D.C. on-state current versus ambient temperature

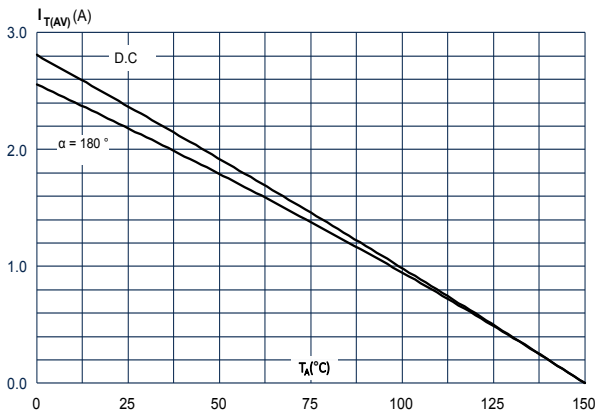

Figure 4. On-state characteristics (maximum values)

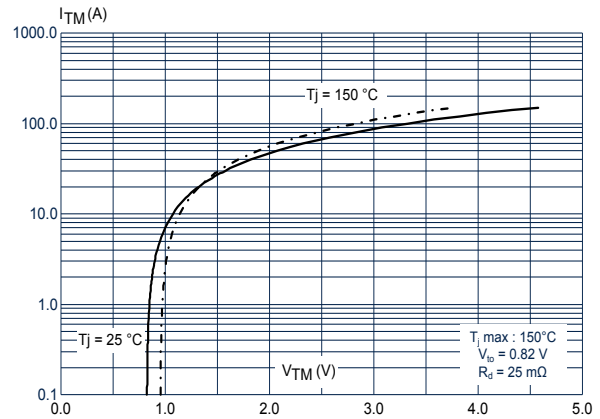

Figure 5. Relative variation of thermal impedance junction to case and junction to ambient versus pulse duration

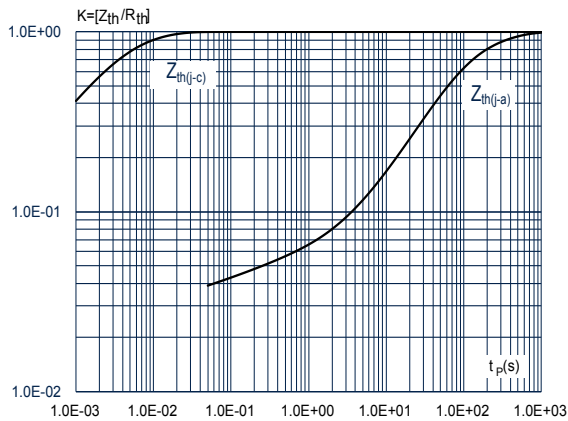

Figure 6. Surge peak on-state current versus number of cycles

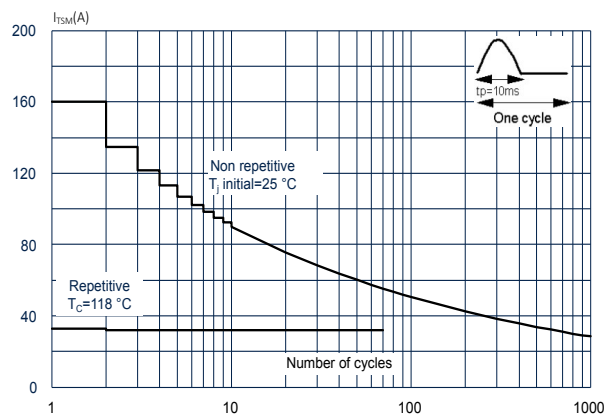

Figure 7. Non repetitive surge peak on-state current for a sinusoidal pulse with width $t_p < 10$ ms

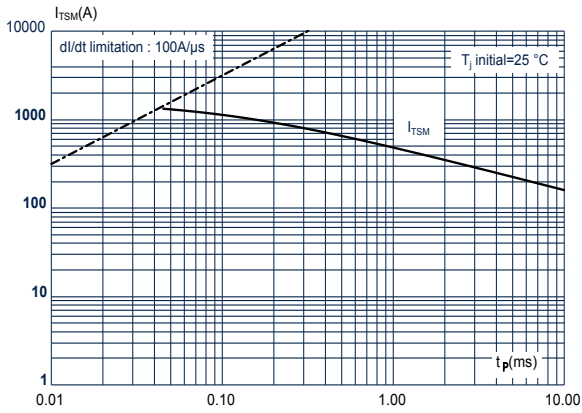

Figure 8. Relative variation of holding current and latching current versus junction temperature (typical values)

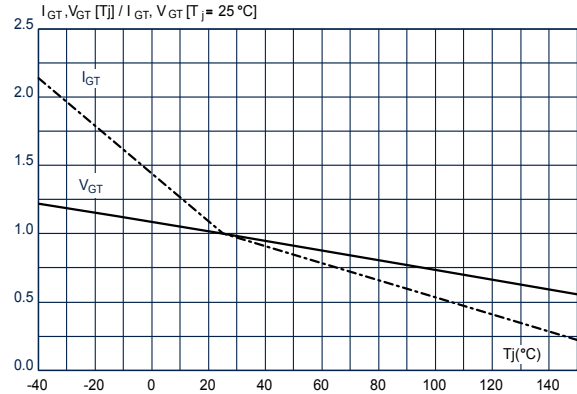

Figure 9. Relative variation of gate triggering current and voltage versus junction temperature (typical values)

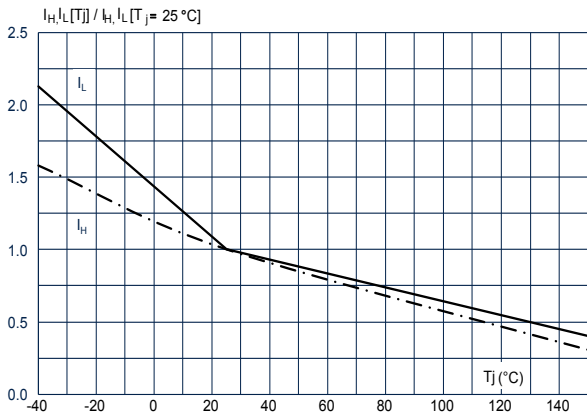

Figure 10. Relative variation of static dV/dt immunity versus junction temperature (typical values)

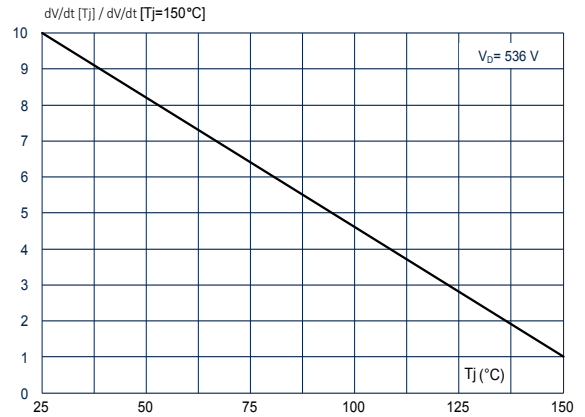
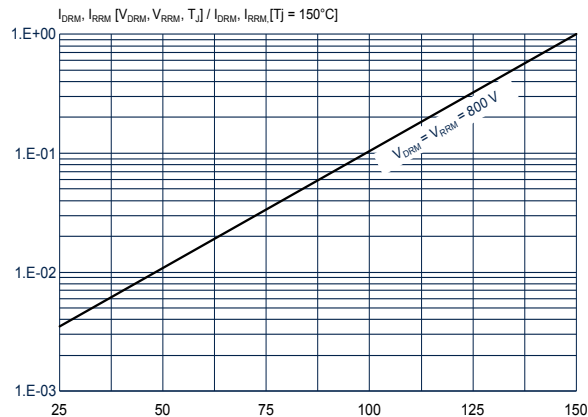

Figure 11. Relative variation of leakage current versus junction temperature for 800 V blocking voltage



2 Package information

In order to meet environmental requirements, ST offers these devices in different grades of **ECOPACK** packages, depending on their level of environmental compliance. ECOPACK specifications, grade definitions and product status are available at: www.st.com. ECOPACK is an ST trademark.

2.1 TO-220AB insulated package information

- Molding compound resin is halogen-free and meets flammability standard UL94 level 0
- Lead-free package leads finishing
- **ECOPACK2** compliant
- Recommended torque: 0.4 to 0.6 N.m

Figure 12. TO-220AB insulated package outline

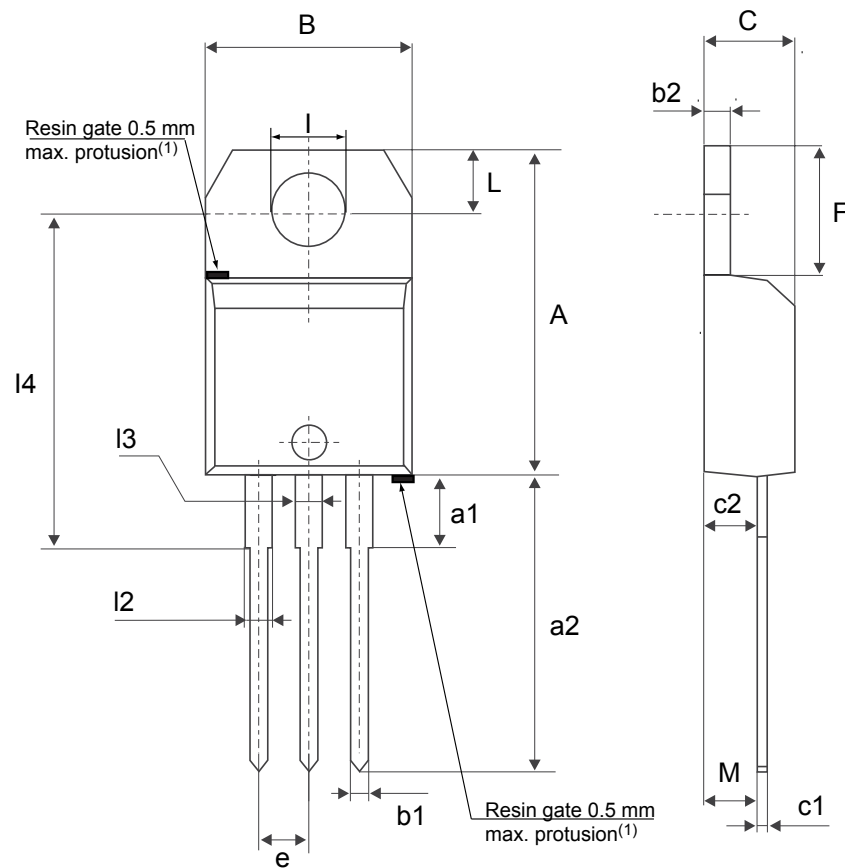

(1) Resin gate position accepted in one of the two positions or in the symmetrical opposites.

Table 5. TO-220AB insulated package mechanical data

Ref.	Dimensions					
	Millimeters			Inches ⁽¹⁾		
	Min.	Typ.	Max.	Min.	Typ.	Max.
A	15.20		15.90	0.5984		0.6260
a1		3.75			0.1476	
a2	13.00		14.00	0.5118		0.5512
B	10.00		10.40	0.3937		0.4094
b1	0.61		0.88	0.0240		0.0346
b2	1.23		1.32	0.0484		0.0520
C	4.40		4.60	0.1732		0.1811
c1	0.49		0.70	0.0193		0.0276
c2	2.40		2.72	0.0945		0.1071
e	2.40		2.70	0.0945		0.1063
F	6.20		6.60	0.2441		0.2598
I	3.73		3.88	0.1469		0.1528
L	2.65		2.95	0.1043		0.1161
I2	1.14		1.70	0.0449		0.0669
I3	1.14		1.70	0.0449		0.0669
I4	15.80	16.40	16.80	0.6220	0.6457	0.6614
M		2.6			0.1024	

1. Inch dimensions are for reference only.

3 Ordering information

Figure 13. Ordering information scheme

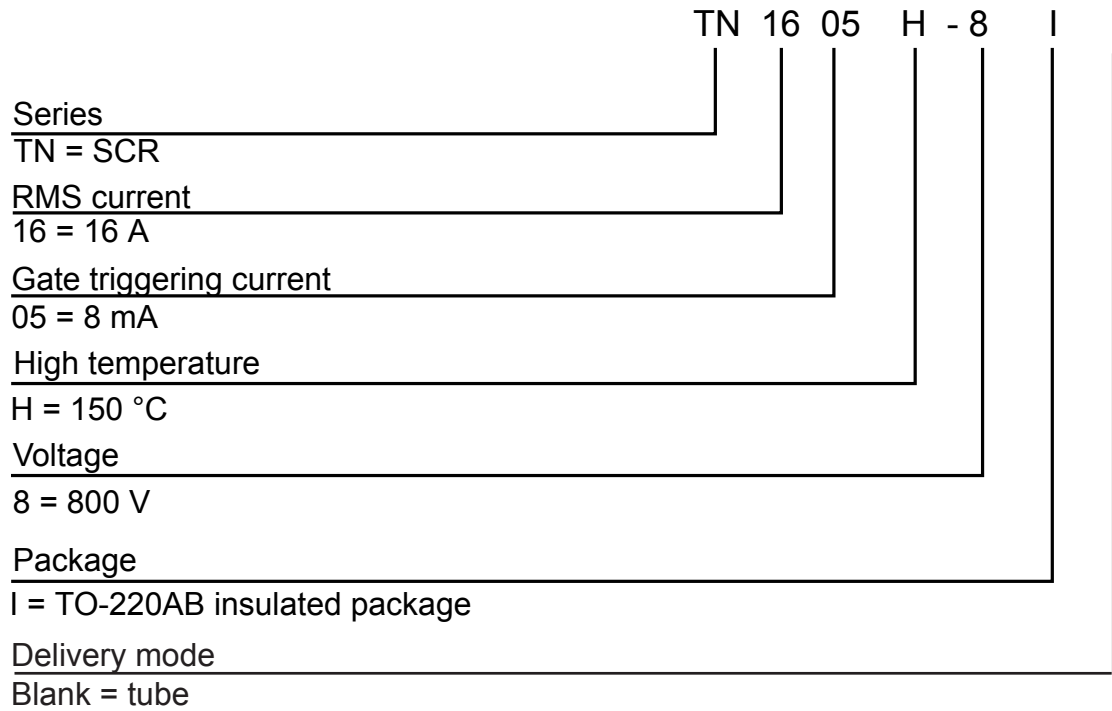

Table 6. Ordering information

Order code	Marking	Package	Weight	Base qty.	Delivery mode
TN1605H-8I	TN1605H8I	TO-220AB ins.	2.3 g	50	Tube

Revision history

Table 7. Document revision history

Date	Revision	Changes
05-Dec-2022	1	Initial release.

IMPORTANT NOTICE – READ CAREFULLY

STMicroelectronics NV and its subsidiaries (“ST”) reserve the right to make changes, corrections, enhancements, modifications, and improvements to ST products and/or to this document at any time without notice. Purchasers should obtain the latest relevant information on ST products before placing orders. ST products are sold pursuant to ST’s terms and conditions of sale in place at the time of order acknowledgment.

Purchasers are solely responsible for the choice, selection, and use of ST products and ST assumes no liability for application assistance or the design of purchasers’ products.

No license, express or implied, to any intellectual property right is granted by ST herein.

Resale of ST products with provisions different from the information set forth herein shall void any warranty granted by ST for such product.

ST and the ST logo are trademarks of ST. For additional information about ST trademarks, refer to www.st.com/trademarks. All other product or service names are the property of their respective owners.

Information in this document supersedes and replaces information previously supplied in any prior versions of this document.

© 2022 STMicroelectronics – All rights reserved