

<b>PART NUMBER</b>		SMD-LX0707RGB-TR	<b>REV</b>	D
<b>REV</b>	<b>E.C.N. NUMBER AND REVISION COMMENTS</b>			<b>DATE</b>
A	ECN-Lumex201800131			08.01.18
B	ECN-Lumex201800140			10.02.18
C	ECN-Lumex201800158			10.17.18
D	ECN-Lumex202000005			01.31.20

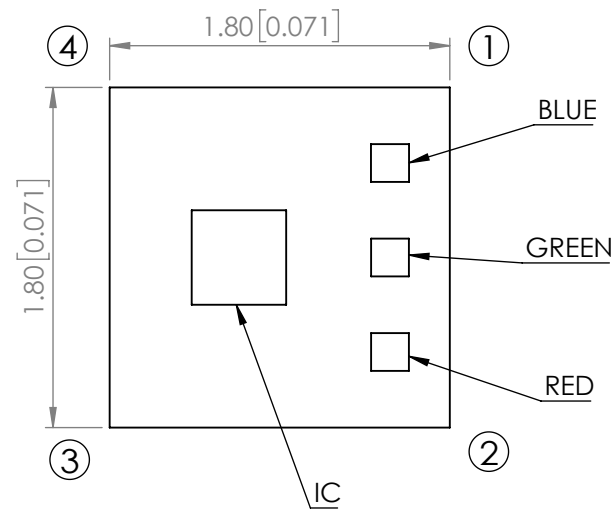

**RECOMMENDED SOLDER PAD LAYOUT**

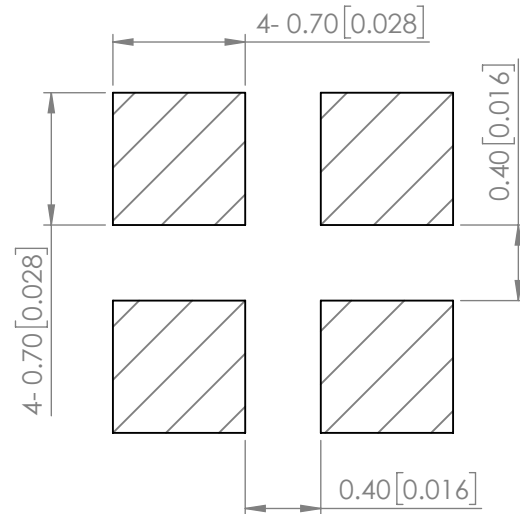

**PIN ASSIMENT**

PIN	SYMBOL	DESCRIPTION
1	DOUT	DATA OUT
2	VDD	POWER VOLTAGE
3	DIN	DATA IN
4	GND	GROUND

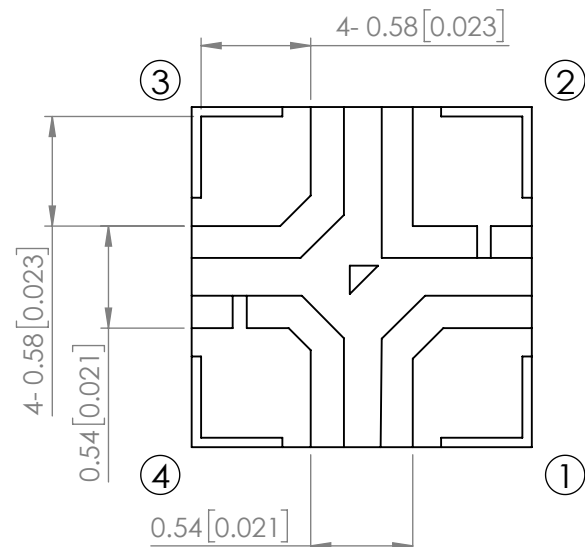

**ELECTRO-OPTICAL CHARACTERISTIC TA=25°C**

PARAMETER		MIN	TYP	MAX	UNITS	TEST COND
SUPPLY VOLTAGE	VDD	-	5	-	V	-
INPUT VOLTAGE(HIGH)	VIH	0.7VDD	-	VDD	V	-
INPUT VOLTAGE(LOW)	VIL	0	-	0.3VDD	V	-
PEAK WAVELENGTH	R	-	630	-	nm	If=5mA
	G	-	520	-		
	B	-	470	-		
LUMINOUS INTENSITY	R	72	-	180	mcd	If=5mA
	G	180	-	360		
	B	28.5	-	72		
VIEWING ANGLE		-	120	-	2x theta1/2	If=5mA
EPOXY LENS FINISH	WATER CLEAR					

**ABSOLUTE MAXIMUM RATINGS TA=25°C**

PARAMETER		MIN	TYP	MAX	UNITS
SUPPLY VOLTAGE	VDD	-	-	5.5	V
STORAGE TEMPERATURE		-40 TO +90			°C
OPERATING TEMPERATURE		-20 TO +70			°C
SOLDERING TEMPERATURE		3 SEC. MAX. @260			°C

**NOTE:**

1. RoHS COMPLIANT.
2. COMPLIANCE WITH EU REACH.
3. COMPLIANCE HALOGEN FREE .  
(Br <900 ppm ,Cl <900 ppm , Br+Cl < 1500 ppm).
4. 2000 PCS/REEL.

**MOISTURE SENSITIVE DEVICE  
PER JEDEC LEVEL 3 STANDARDS**

\*UNLESS OTHERWISE SPECIFIED TOLERANCES PER DECIMAL PRECISION ARE: X=±1 (±0.039), X.X=±0.5 (±0.020), X.XX=±0.25 (±0.010), X.XXX=±0.127 (±0.005). LEAD SIZE=±0.05 (±0.002), LEAD LENGTH=±0.75 (±0.030). MIN= <sup>+DECIMAL PRECISION</sup>/<sub>-0.00</sub> MAX.= <sup>+0.00</sup>/<sub>-DECIMAL PRECISION</sub>

**RECOMMENDED OPERATING CONDITION Ta=-20~70°C , VSS=0V**

PARAMETER	MIN	TYP	MAX	UNITS	TEST COND
PROPAGATION DELAY TIME					DIN→DOUT CL=15pF, RL=10KΩ
FALLING TIME					CL=300pF OUTR/OUTG/OUTB
INPUT CAPACITOR					

**TIMING WAVE FORM**

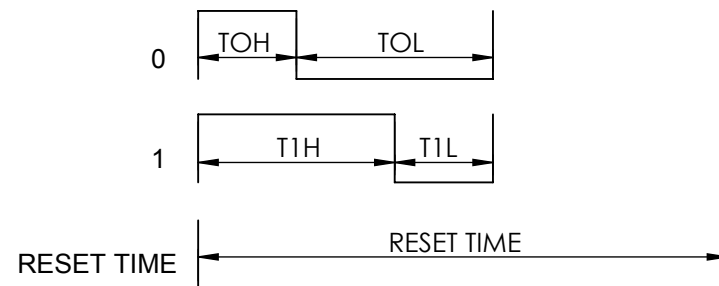

**HIGH SPEED MODE**

ITEM	DESCRIPTION	TYP.	ALLOWANCE
T0H	0 CODE, HIGH-LEVEL TIME	300ns	±80ns
T0L	0 CODE, LOW-LEVEL TIME	900ns	±80ns
T1H	1 CODE, HIGH-LEVEL TIME	900ns	±80ns
T1L	1 CODE, LOW-LEVEL TIME	300ns	±80ns
RES	RESET TIME	>50us	-

**DATA COMMUNICATION**



**SINGLE DATA IN 24BIT FOR RGB**

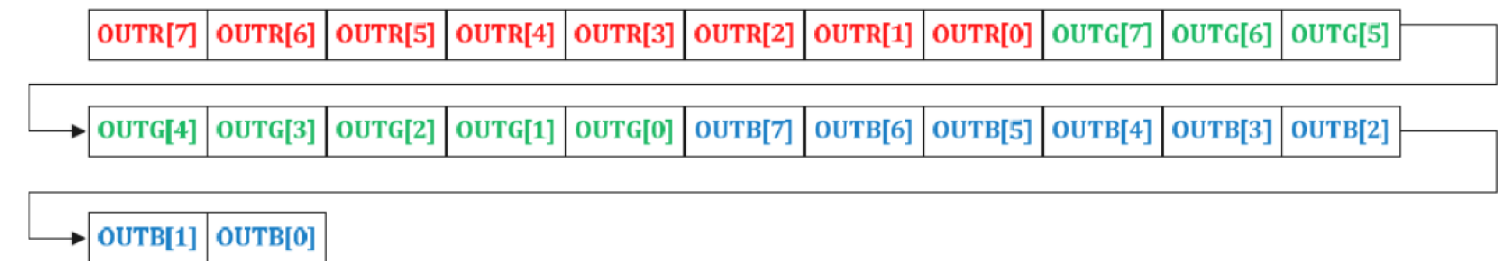

**5V APPLICATION CIRCUIT**

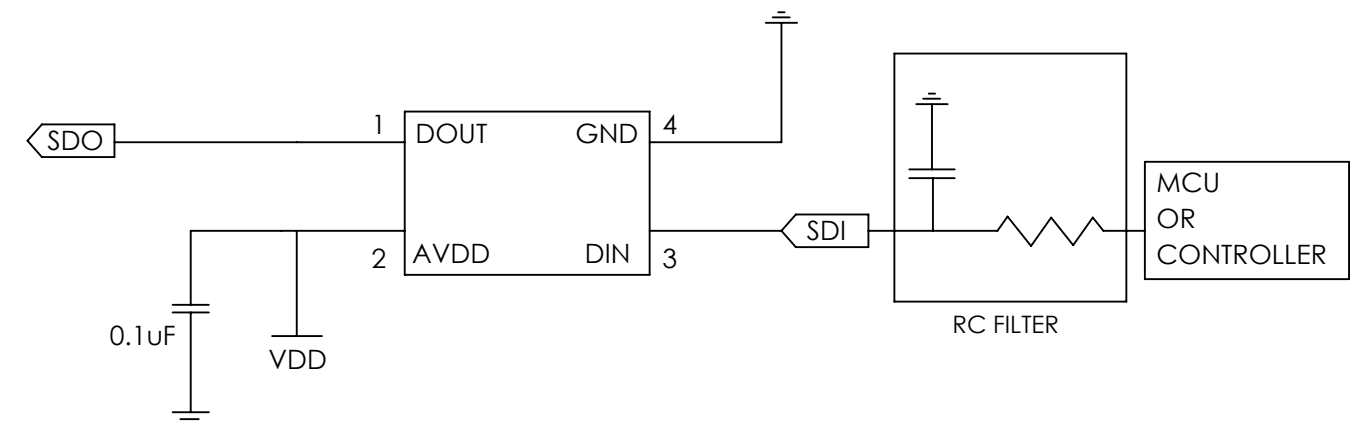

\*UNLESS OTHERWISE SPECIFIED TOLERANCES PER DECIMAL PRECISION ARE: X=±1 (±0.039), X.X=±0.5 (±0.020), X.XX=±0.25 (±0.010), X.XXX=±0.127 (±0.005). LEAD SIZE=±0.05 (±0.002), LEAD LENGTH=±0.75 (±0.030). MIN= <sup>+DECIMAL PRECISION</sup>/<sub>-0.00</sub> MAX= <sup>+0.00</sup>/<sub>-DECIMAL PRECISION</sub>

**PROFILE**

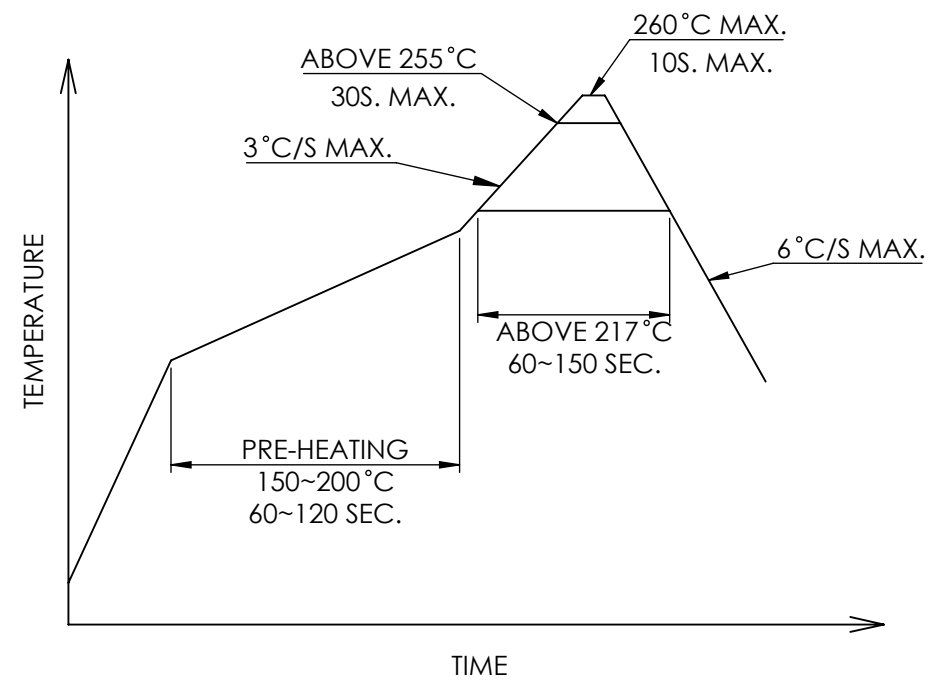

**CARRIER TAPE DIMENSION**

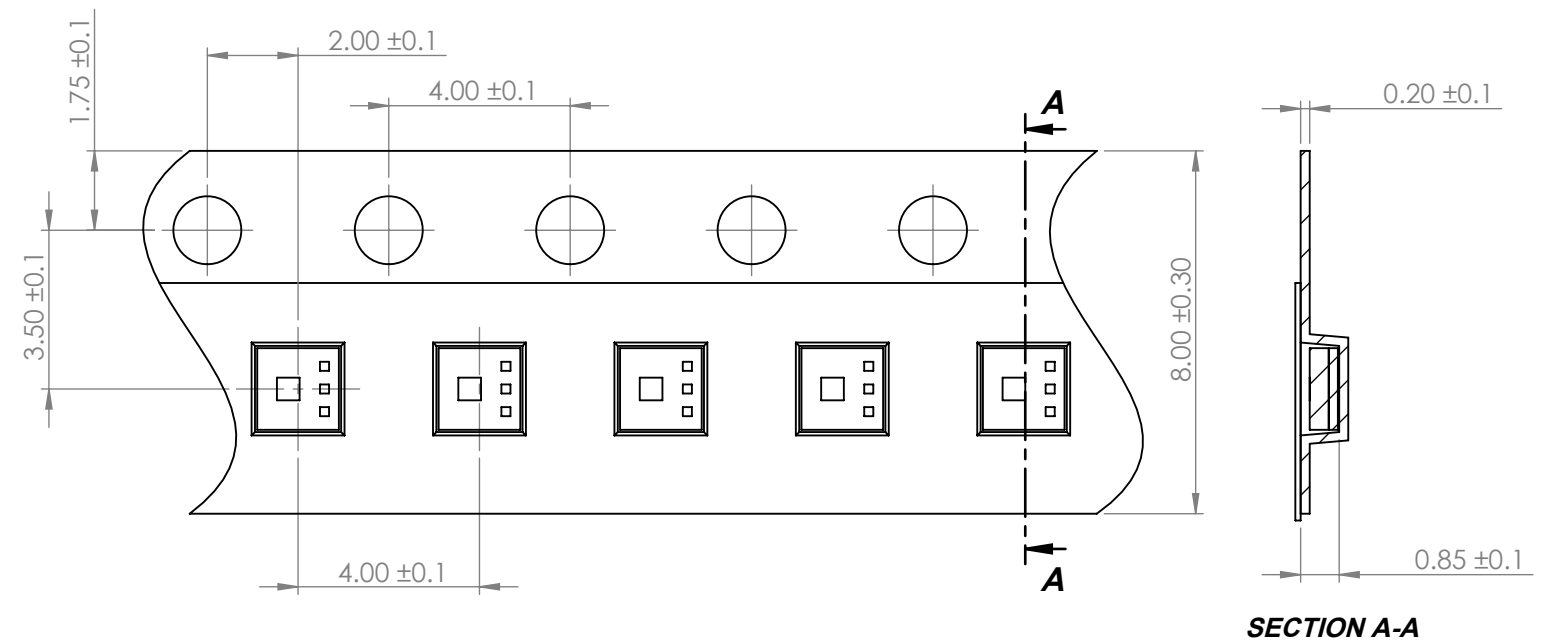

\*UNLESS OTHERWISE SPECIFIED TOLERANCES PER DECIMAL PRECISION ARE: X=±1 (±0.039), X.X=±0.5 (±0.020), X.XX=±0.25 (±0.010), X.XXX=±0.127 (±0.005). LEAD SIZE=±0.05 (±0.002), LEAD LENGTH=±0.75 (±0.030). MIN= <sup>+DECIMAL PRECISION</sup>/<sub>-0.00</sub> MAX.= <sup>+0.00</sup>/<sub>-DECIMAL PRECISION</sub>

 <p>425 N. GARY AVE. CAROL STREAM, IL 60188 PHONE : 800-278-5666 FAX : 630-315-2150 WEB : WWW.LUMEX.COM</p>	1.8(L)*1.8(W)*0.65(H)mm, SURFACE MOUNT LED, RGB FULL COLOR, 3-CHANNELS LED DRIVER WITH 8 bit PWM LINEAR CONTROL, WATER CLEAR LENS, TAPE & REEL	DATE : 2018.06.29	DRAWN BY : E.C.	
	**THE SPECIFICATIONS MAY CHANGE AT ANY TIME WITHOUT NOTICE.**	PAGE : 3 OF 4	CHKD BY : E.C.	
	CONFIDENTIAL INFORMATION	SCALE : NTF	APRVD BY : G.Y.	
	THE INFORMATION CONTAINED IN THIS DOCUMENT IS THE PROPERTY OF LUMEX INC. EXCEPT AS SPECIFICALLY AUTHORIZED IN WRITING BY LUMEX INC., THE HOLDER OF THIS DOCUMENT SHALL KEEP ALL INFORMATION CONTAINED HEREIN CONFIDENTIAL AND SHALL PROTECT SAME IN WHOLE OR IN PART FROM DISCLOSURE AND DISSEMINATION TO ALL THIRD PARTIES.	UNIT : mm [INCH]	Pb	

**EXAMPLE OF USING STM32F030C8T6 TO DISPLAY RED, GREEN AND BLUE IN SEQUENCE**

```

/*****/
uint8_t LED_Number_Per_Ring = 60;
uint32_t Ring_0_Display_memory[60];

void Display_One_Dot(uint32_t color);
void Embedded_One(void);
void Embedded_Zero(void);
void Init_GPIOs(void);

void main(void)
{
  Init_GPIOs();
  while (1)
  {
    Ring_0_Display_memory[0] = 0xFF0000;
    Send_Whole_Ring_from_Ring_Memory();
    delay_ms(1000);
    Ring_0_Display_memory[1] = 0x00FF00;
    Send_Whole_Ring_from_Ring_Memory();
    delay_ms(1000);
    Ring_0_Display_memory[2] = 0x0000FF;
    Send_Whole_Ring_from_Ring_Memory();
    delay_ms(1000);
  }
}

```

```

/*****/
void Send_Whole_Ring_from_Ring_Memory(void)
{
  uint8_t j=0;
  uint32_t x,y;
  for (i=0;i<LED_Number_Per_Ring+10;i++)
  {
    y = Ring_0_Display_memory[i];
    for (j=0;j<8;j++)
    {
      x = (y & 0x800000);
      if (x>0)
        Embedded_One();
      else
        Embedded_Zero();
      y = y << 1;
    }
    y = Ring_0_Display_memory[i];
    for (j=0;j<8;j++)
    {
      x = (y & 0x008000);
      if (x>0)
        Embedded_One();
      else
        Embedded_Zero();
      y = y << 1;
    }
  }
  delay_us(80);
}

```

```

/*****/
void Embedded_Zero(void)
{
  GPIO_SetBits(GPIOB,GPIO_Pin_12);
  GPIO_ResetBits(GPIOB,GPIO_Pin_12);
  GPIO_ResetBits(GPIOB,GPIO_Pin_12);
  GPIO_ResetBits(GPIOB,GPIO_Pin_12);
}

/*****/
void Embedded_One(void)
{
  GPIO_SetBits(GPIOB,GPIO_Pin_12);
  GPIO_SetBits(GPIOB,GPIO_Pin_12);
  GPIO_SetBits(GPIOB,GPIO_Pin_12);
  GPIO_ResetBits(GPIOB,GPIO_Pin_12);
}

/*****/
void Init_GPIOs(void)
{
  GPIO_InitTypeDef GPIO_InitStructure;
  RCC_AHBPeriphClockCmd(RCC_AHBPeriph_GPIOB,ENABLE);

  GPIO_InitStructure.GPIO_Pin = GPIO_Pin_12
  GPIO_InitStructure.GPIO_Mode = GPIO_Mode_OUT;
  GPIO_InitStructure.GPIO_OType = GPIO_OType_PP;
  GPIO_InitStructure.GPIO_PuPd = GPIO_PuPd_UP;
  GPIO_InitStructure.GPIO_Speed = GPIO_Speed_50MHz;
  GPIO_Init(GPIOB, &GPIO_InitStructure);
}

```

\*UNLESS OTHERWISE SPECIFIED TOLERANCES PER DECIMAL PRECISION ARE: X=±1 (±0.039), X.X=±0.5 (±0.020), X.XX=±0.25 (±0.010), X.XXX=±0.127 (±0.005). LEAD SIZE=±0.05 (±0.002), LEAD LENGTH=±0.75 (±0.030). MIN= <sup>+DECIMAL PRECISION</sup> -0.00 MAX= <sup>+0.00</sup> -DECIMAL PRECISION



425 N. GARY AVE.  
CAROL STREAM, IL 60188  
PHONE : 800-278-5666  
FAX : 630-315-2150  
WEB : WWW.LUMEX.COM

1.8(L)\*1.8(W)\*0.65(H)mm, SURFACE MOUNT LED, RGB FULL COLOR, 3-CHANNELS LED DRIVER WITH 8 bit PWM LINEAR CONTROL, WATER CLEAR LENS, TAPE & REEL

DATE : 2018.06.29

DRAWN BY : E.C.

\*\*THE SPECIFICATIONS MAY CHANGE AT ANY TIME WITHOUT NOTICE.\*\*

PAGE : 4 OF 4

CHKD BY : E.C.

CONFIDENTIAL INFORMATION  
THE INFORMATION CONTAINED IN THIS DOCUMENT IS THE PROPERTY OF LUMEX INC. EXCEPT AS SPECIFICALLY AUTHORIZED IN WRITING BY LUMEX INC., THE HOLDER OF THIS DOCUMENT SHALL KEEP ALL INFORMATION CONTAINED HEREIN CONFIDENTIAL AND SHALL PROTECT SAME IN WHOLE OR IN PART FROM DISCLOSURE AND DISSEMINATION TO ALL THIRD PARTIES.

SCALE : NTF

APRVD BY : G.Y.

UNIT : mm [INCH]

(Pb)