

# Getting started with Raspberry Pi Pico

C/C++ development with  
Raspberry Pi Pico and  
other RP2040-based  
microcontroller boards

# Colophon

Copyright © 2020 Raspberry Pi (Trading) Ltd.

The documentation of the RP2040 microcontroller is licensed under a Creative Commons [Attribution-NoDerivatives 4.0 International](#) (CC BY-ND).

build-date: 2021-01-21

build-version: fcd04ef-clean

## Legal Disclaimer Notice

TECHNICAL AND RELIABILITY DATA FOR RASPBERRY PI PRODUCTS (INCLUDING DATASHEETS) AS MODIFIED FROM TIME TO TIME ("RESOURCES") ARE PROVIDED BY RASPBERRY PI (TRADING) LTD ("RPTL") "AS IS" AND ANY EXPRESS OR IMPLIED WARRANTIES, INCLUDING, BUT NOT LIMITED TO, THE IMPLIED WARRANTIES OF MERCHANTABILITY AND FITNESS FOR A PARTICULAR PURPOSE ARE DISCLAIMED. TO THE MAXIMUM EXTENT PERMITTED BY APPLICABLE LAW IN NO EVENT SHALL RPTL BE LIABLE FOR ANY DIRECT, INDIRECT, INCIDENTAL, SPECIAL, EXEMPLARY, OR CONSEQUENTIAL DAMAGES (INCLUDING, BUT NOT LIMITED TO, PROCUREMENT OF SUBSTITUTE GOODS OR SERVICES; LOSS OF USE, DATA, OR PROFITS; OR BUSINESS INTERRUPTION) HOWEVER CAUSED AND ON ANY THEORY OF LIABILITY, WHETHER IN CONTRACT, STRICT LIABILITY, OR TORT (INCLUDING NEGLIGENCE OR OTHERWISE) ARISING IN ANY WAY OUT OF THE USE OF THE RESOURCES, EVEN IF ADVISED OF THE POSSIBILITY OF SUCH DAMAGE.

RPTL reserves the right to make any enhancements, improvements, corrections or any other modifications to the RESOURCES or any products described in them at any time and without further notice.

The RESOURCES are intended for skilled users with suitable levels of design knowledge. Users are solely responsible for their selection and use of the RESOURCES and any application of the products described in them. User agrees to indemnify and hold RPTL harmless against all liabilities, costs, damages or other losses arising out of their use of the RESOURCES.

RPTL grants users permission to use the RESOURCES solely in conjunction with the Raspberry Pi products. All other use of the RESOURCES is prohibited. No licence is granted to any other RPTL or other third party intellectual property right.

HIGH RISK ACTIVITIES. Raspberry Pi products are not designed, manufactured or intended for use in hazardous environments requiring fail safe performance, such as in the operation of nuclear facilities, aircraft navigation or communication systems, air traffic control, weapons systems or safety-critical applications (including life support systems and other medical devices), in which the failure of the products could lead directly to death, personal injury or severe physical or environmental damage ("High Risk Activities"). RPTL specifically disclaims any express or implied warranty of fitness for High Risk Activities and accepts no liability for use or inclusions of Raspberry Pi products in High Risk Activities.

Raspberry Pi products are provided subject to RPTL's [Standard Terms](#). RPTL's provision of the RESOURCES does not expand or otherwise modify RPTL's [Standard Terms](#) including but not limited to the disclaimers and warranties expressed in them.



# Table of Contents

Colophon .....	1
Legal Disclaimer Notice .....	1
1. Quick Pico Setup .....	4
2. The Pico SDK .....	5
2.1. Get the Pico SDK and examples .....	5
2.2. Install the Toolchain .....	6
3. Blinking an LED in C .....	7
3.1. Building "Blink" .....	7
3.2. Load and run "Blink" .....	8
3.2.1. From the desktop .....	9
3.2.2. Using the command line .....	9
4. Saying "Hello World" in C .....	11
4.1. Serial input and output on Raspberry Pi Pico .....	11
4.2. Build "Hello World" .....	12
4.3. Flash and Run "Hello World" .....	13
4.4. See "Hello World" USB output .....	13
4.5. See "Hello World" UART output .....	14
4.6. Powering the board .....	15
5. Debugging with SWD .....	17
5.1. Build "Hello World" debug version .....	17
5.2. Installing OpenOCD .....	17
5.3. Installing GDB .....	18
5.4. Use GDB and OpenOCD to debug Hello World .....	19
6. Using Visual Studio Code .....	21
6.1. Installing Visual Studio Code .....	21
6.2. Loading a Project .....	21
6.3. Debugging a Project .....	23
6.3.1. Running "Hello World" on the Raspberry Pi Pico .....	24
7. Creating your own Project .....	26
7.1. Debugging your project .....	28
7.2. Working in Visual Studio Code .....	29
7.3. Automating project creation .....	29
7.3.1. Project generation from the command line .....	31
8. Building on other platforms .....	32
8.1. Building on Apple macOS .....	32
8.1.1. Installing the Toolchain .....	32
8.1.2. Using Visual Studio Code .....	32
8.1.3. Building with CMake Tools .....	32
8.1.4. Saying "Hello World" .....	33
8.2. Building on MS Windows .....	34
8.2.1. Installing the Toolchain .....	34
8.2.2. Getting the Pico SDK and examples .....	37
8.2.3. Building "Hello World" from the Command Line .....	37
8.2.4. Building "Hello World" from Visual Studio Code .....	38
8.2.5. Flashing and Running "Hello World" .....	39
9. Using other Integrated Development Environments .....	41
9.1. Using Eclipse .....	41
9.1.1. Setting up Eclipse for Pico on a Linux machine .....	41
9.2. Using CLion .....	45
9.2.1. Setting up CLion .....	46
9.3. Other Environments .....	49
9.3.1. Using openocd-svd .....	49
Appendix A: Using Picoprobe .....	52
A.1. Build OpenOCD .....	52
A.1.1. Linux .....	52

A.1.2. Windows .....	52
A.1.3. Mac .....	54
A.2. Build and flash picoprobe .....	55
A.3. Picoprobe Wiring .....	55
A.4. Install Picoprobe driver (only needed on Windows) .....	56
A.5. Using Picoprobe's UART .....	57
A.5.1. Linux .....	57
A.5.2. Windows .....	57
A.5.3. Mac .....	58
A.6. Using Picoprobe with OpenOCD .....	59
Appendix B: Using Picotool .....	60
B.1. Getting picotool .....	60
B.2. Building picotool .....	60
B.3. Using picotool .....	61
B.3.1. Display information .....	61
B.3.2. Save the program .....	63
B.4. Binary Information .....	64
B.4.1. Basic information .....	64
B.4.2. Pins .....	65
B.4.3. Including Binary information .....	65
B.4.4. Details .....	66
B.4.5. Setting common fields from CMake .....	67

# Chapter 1. Quick Pico Setup

If you are developing for Raspberry Pi Pico on the Raspberry Pi 4B, or the Raspberry Pi 400, most of the installation steps in this Getting Started guide can be skipped by running the setup script. You can get this script by doing the following:

```
$ git clone https://github.com/raspberrypi/pico-setup.git ⓘ
```

1. You should first `sudo apt install git` if you don't have Git already installed.

Then run,

```
$ pico-setup/pico_setup.sh
```

The script will:

- Create a directory called `pico`
- Install required dependencies
- Download the `pico-sdk`, `pico-examples`, `pico-extras`, and `pico-playground` repositories
- Define `PICO_SDK_PATH`, `PICO_EXAMPLES_PATH`, `PICO_EXTRAS_PATH`, and `PICO_PLAYGROUND_PATH` in your `~/.bashrc`
- Build the `blink` and `hello_world` examples in `pico-examples/build/blink` and `pico-examples/build/hello_world`
- Download and build `picotool` (see [Appendix B](#)). Copy it to `/usr/local/bin`.
- Download and build `picoprobe` (see [Appendix A](#)).
- Download and compile OpenOCD (for debug support)
- Download and install [Visual Studio Code](#)
- Install the required Visual Studio Code extensions (see [Chapter 6](#) for more details)
- Configure the Raspberry Pi UART for use with Raspberry Pi Pico

Once it has run, you will need to reboot your Raspberry Pi,

```
$ sudo reboot
```

for the UART reconfiguration to take effect.

Once your Raspberry Pi has rebooted you can open Visual Studio Code in the "Programming" menu and follow the instructions from [Section 6.2](#).

# Chapter 2. The Pico SDK

## ! IMPORTANT

The following instructions assume that you are using a Raspberry Pi Pico and some details may differ if you are using a different RP2040-based board. They also assume you are using Raspberry Pi OS running on a Raspberry Pi 4, or an equivalent Debian-based Linux distribution running on another platform. Alternative instructions for those using Microsoft Windows (see [Section 8.2](#)) or Apple macOS (see [Section 8.1](#)) are also provided.

The Raspberry Pi Pico is built around the RP2040 microcontroller designed by Raspberry Pi. Development on the board is fully supported with both a C/C++ SDK, and an official MicroPython port. This book talks about how to get started with the SDK, and walks you through how to build, install, and work with the SDK toolchain.

## 💡 TIP

For more information on the official MicroPython port see the [Pico Python SDK](#) book which documents the port, and "[Get started with MicroPython on Raspberry Pi Pico](#)" by Gareth Halfacree published by Raspberry Pi Press.

## 💡 TIP

For more information on the C/C++ SDK, along with API-level documentation, see the [Pico C/C++ SDK](#) book.

## 2.1. Get the Pico SDK and examples

The `pico-examples` repository (<https://github.com/raspberrypi/pico-examples>) provides a set of example applications that are written using the `pico-sdk` (<https://github.com/raspberrypi/pico-sdk>). To clone these repositories start by creating a `pico` directory to keep all pico related checkouts in. These instructions create a `pico` directory at `/home/pi/pico`.

```
$ cd ~/
$ mkdir pico
$ cd pico
```

Then clone the `pico-sdk` and `pico-examples` git repositories.

```
$ git clone -b master https://github.com/raspberrypi/pico-sdk.git
$ cd pico-sdk
$ git submodule update --init
$ cd ..
$ git clone -b master https://github.com/raspberrypi/pico-examples.git
```

**i** NOTE

There are additional repositories: [pico-extras](#), and [pico-playground](#) that you may also be interested in.

## 2.2. Install the Toolchain

To build the applications in [pico-examples](#), you'll need to install some extra tools. To build projects you'll need [CMake](#), a cross-platform tool used to build the software, and the [GNU Embedded Toolchain for Arm](#). You can install both these via [apt](#) from the command line. Anything you already have installed will be ignored by [apt](#).

```
$ sudo apt update
$ sudo apt install cmake gcc-arm-none-eabi build-essential ⓘ
```

1. Native gcc and g++ are needed to compile pioasm, elf2uf2

# Chapter 3. Blinking an LED in C

When you're writing software for hardware, turning an LED on, off, and then on again, is typically the first program that gets run in a new programming environment. Learning how to blink an LED gets you half way to anywhere. We're going to go ahead and blink the on-board LED on the Raspberry Pi Pico which is connected to pin 25 of the RP2040.

Pico Examples: <https://github.com/raspberrypi/pico-examples/tree/master/blink/blink.c> Lines 9 - 19

```
9 int main() {
10     const uint LED_PIN = 25;
11     gpio_init(LED_PIN);
12     gpio_set_dir(LED_PIN, GPIO_OUT);
13     while (true) {
14         gpio_put(LED_PIN, 1);
15         sleep_ms(250);
16         gpio_put(LED_PIN, 0);
17         sleep_ms(250);
18     }
19 }
```

## 3.1. Building "Blink"

From the pico directory we created earlier, cd into `pico-examples` and create a build directory.

```
$ cd pico-examples
$ mkdir build
$ cd build
```

Then, assuming you cloned the `pico-sdk` and `pico-examples` repositories into the same directory side-by-side, set the `PICO_SDK_PATH`:

```
$ export PICO_SDK_PATH=../../pico-sdk
```

Prepare your cmake build directory by running `cmake ..`

```
$ cmake ..
Using PICO_SDK_PATH from environment ('../../pico-sdk')
PICO SDK is located at /home/pi/pico/pico-sdk
.
.
.
-- Build files have been written to: /home/pi/pico/pico-examples/build
```

**i NOTE**

`cmake` will default to a **Release** build with compiler optimisations enabled and debugging information removed. To build a debug version, run `cmake -DCMAKE_BUILD_TYPE=Debug ...`. We will explore this later in [Section 5.1](#).

CMake has now prepared a build area for the `pico-examples` tree. From here, it is possible to type `make` to build all example applications. However, as we are building `blink` we will only build that application for now by changing directory into the `blink` directory before typing `make`.

**💡 TIP**

Invoking `make` with `-j4` will run four make jobs in parallel to speed it up. A Raspberry Pi 4 has 4 cores so `-j4` is a reasonable number.

```
$ cd blink
$ make -j4
Scanning dependencies of target ELF2UF2Build
Scanning dependencies of target boot_stage2_original
[ 0%] Creating directories for 'ELF2UF2Build'
.
.
.
[100%] Linking CXX executable blink.elf
[100%] Built target blink
```

Amongst other targets, we have now built:

- `blink.elf`, which is used by the debugger
- `blink.uf2`, which can be dragged onto the RP2040 USB Mass Storage Device

This binary will blink the on-board LED of the Raspberry Pi Pico which is connected to GPIO25 of RP2040.

## 3.2. Load and run "Blink"

The simplest method to load software onto a RP2040-based board is by mounting it as a USB Mass Storage Device. Doing this allows you to drag a file onto the board to program the flash. Go ahead and connect the Raspberry Pi Pico to your Raspberry Pi using a micro-USB cable, making sure that you hold down the `BOOTSEL` button ([Figure 1](#)) to force it into USB Mass Storage Mode.

**i NOTE**

Loading code via the USB Mass Storage method is great if you know your program is going to work first time, but if you are developing anything new it is likely you will want to debug it. So you can also load your software onto RP2040 using the Serial Wire Debug interface, see [Chapter 5](#). As well as loading software this allows you to; set breakpoints, inspect variables, and inspect memory contents.

**i NOTE**

If you are not following these instructions on a Raspberry Pi Pico, you may not have a **BOOTSEL** button, see [Figure 1](#). If this is the case, you should check if there is some other way grounding the flash **CS** pin, such as a jumper, to tell RP2040 to enter the **BOOTSEL** mode on boot. If there is no such method, you can load code using the Serial Wire Debug interface.

### 3.2.1. From the desktop

If you are running the Raspberry Pi Desktop the Raspberry Pi Pico should automatically mount as a USB Mass Storage Device. From here, you can Drag-and-drop **blink.uf2** onto the Mass Storage Device.

RP2040 will reboot, unmounting itself as a Mass Storage Device, and start to run the flashed code, see [Figure 1](#).

Figure 1. Blinking the on-board LED on the Raspberry Pi Pico. Arrows point to the on-board LED, and the **BOOTSEL** button.

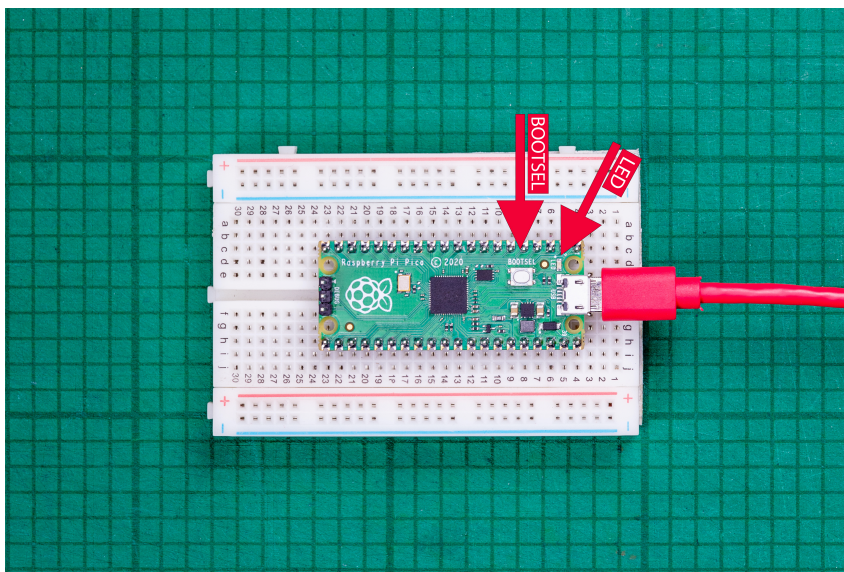

### 3.2.2. Using the command line

If you are logged in via **ssh** for example, you may have to mount the mass storage device manually:

```
$ dmesg | tail
[ 371.973555] sd 0:0:0:0: [sda] Attached SCSI removable disk
$ sudo mkdir -p /mnt/pico
$ sudo mount /dev/sda1 /mnt/pico
```

If you can see files in **/mnt/pico** then the USB Mass Storage Device has been mounted correctly:

```
$ ls /mnt/pico/
INDEX.HTM  INFO_UF2.TXT
```

Copy your **blink.uf2** onto RP2040:

```
sudo cp blink.uf2 /mnt/pico
sudo sync
```



RP2040 has already disconnected as a USB Mass Storage Device and is running your code, but for tidiness unmount `/mnt/pico`

```
sudo umount /mnt/pico
```

**i NOTE**

Removing power from the board does not remove the code. When the board is reattached to power the code you have just loaded will begin running again. If you want to remove the code from the board, and upload new code, press and hold the BOOTSEL switch when applying power to put the board into Mass Storage mode.

**Need more detail?**

This document shows how to build software and load it onto your Raspberry Pi Pico. A lot goes on behind the scenes to turn our `blink` application into a binary program, and the [Pico C/C++ SDK](#) book pulls back the curtain and shows some of the machinery involved. If you aren't worried about this kind of thing yet, read on!

# Chapter 4. Saying "Hello World" in C

After blinking an LED on and off, the next thing that most developers will want to do is create and use a serial port, and say "Hello World."

*Pico Examples:* [https://github.com/raspberrypi/pico-examples/tree/master/hello\\_world/serial/hello\\_serial.c](https://github.com/raspberrypi/pico-examples/tree/master/hello_world/serial/hello_serial.c) Lines 10 - 17

```

10 int main() {
11     stdio_init_all();
12     while (true) {
13         printf("Hello, world!\n");
14         sleep_ms(1000);
15     }
16     return 0;
17 }

```

## 4.1. Serial input and output on Raspberry Pi Pico

Serial input (`stdin`) and output (`stdout`) can be directed to either serial UART or to USB CDC (USB serial). However by default `stdio` and `printf` will target the default Raspberry Pi Pico UART0.

Raspberry Pi Pico Default UART0
GND (Pin 3)
GP0 (UART0_TX, Pin 1)
GP1 (UART0_RX, Pin 2)

### ! IMPORTANT

The default Raspberry Pi Pico UART TX pin (out from Raspberry Pi Pico) is pin GP0, and the UART RX pin (in to Raspberry Pi Pico) is pin GP1. The default UART pins are configured on a per-board basis using board configuration files. The Raspberry Pi Pico configuration can be found in <https://github.com/raspberrypi/pico-sdk/tree/master/src/boards/include/boards/pico.h>. The Pico SDK defaults to a board name of Raspberry Pi Pico if no other board is specified.

The Pico SDK makes use of CMake to control its build system, see [Chapter 7](#), making use of the `pico_stdlib` interface library to aggregate necessary source files to provide capabilities.

*Pico Examples:* [https://github.com/raspberrypi/pico-examples/tree/master/hello\\_world/serial/CMakeLists.txt](https://github.com/raspberrypi/pico-examples/tree/master/hello_world/serial/CMakeLists.txt) Lines 1 - 12

```

1 add_executable(hello_serial
2     hello_serial.c
3 )
4
5 # Pull in our pico_stdlib which aggregates commonly used features
6 target_link_libraries(hello_serial pico_stdlib)
7
8 # create map/bin/hex/uf2 file etc.
9 pico_add_extra_outputs(hello_serial)
10
11 # add url via pico_set_program_url
12 example_auto_set_url(hello_serial)

```

The destination for `stdout` can be changed using CMake directives, with output directed to UART or USB CDC, or to both,

```
pico_enable_stdio_usb(hello_world 1) ①
pico_enable_stdio_uart(hello_world 0) ②
```

1. Enable `printf` output via USB CDC (USB serial)
2. Disable `printf` output via UART

This means that **without changing the C source code**, you can change the destination for `stdio` from UART to USB.

*Pico Examples:* [https://github.com/raspberrypi/pico-examples/tree/master/hello\\_world/usb/CMakeLists.txt](https://github.com/raspberrypi/pico-examples/tree/master/hello_world/usb/CMakeLists.txt) Lines 1 - 16

```
1 add_executable(hello_usb
2     hello_usb.c
3 )
4
5 # Pull in our pico_stdlib which aggregates commonly used features
6 target_link_libraries(hello_usb pico_stdlib)
7
8 # enable usb output, disable uart output
9 pico_enable_stdio_usb(hello_usb 1)
10 pico_enable_stdio_uart(hello_usb 0)
11
12 # create map/bin/hex/uf2 file etc.
13 pico_add_extra_outputs(hello_usb)
14
15 # add url via pico_set_program_url
16 example_auto_set_url(hello_usb)
```

## 4.2. Build "Hello World"

As we did for the previous "Blink" example, change directory into the `hello_world` directory inside the `pico-examples` tree, and run `make`.

```
$ cd hello_world
$ make -j4
Scanning dependencies of target ELF2UF2Build
[ 0%] Creating directories for 'ELF2UF2Build'
.
.
[ 33%] Linking CXX executable hello_usb.elf
[ 33%] Built target hello_usb
.
.
[100%] Linking CXX executable hello_serial.elf
[100%] Built target hello_serial
```

This will build two separate examples programs in the `hello_world/serial/` and `hello_world/usb/` directories.

Amongst other targets, we have now built:

- `serial/hello_serial.elf`, which is used by the debugger



**TIP**

To exit minicom, use **CTRL-A** followed by **X**.

## 4.5. See "Hello World" UART output

Alternatively if you dragged and dropped the `hello_usb.uf2` binary, then the "Hello World" text will be directed to UART0 on pins GP0 and GP1. The first thing you'll need to do to see the text is enable UART serial communications on the Raspberry Pi host. To do so, run `raspi-config`,

```
$ sudo raspi-config
```

and go to **Interfacing Options** → **Serial** and select "No" when asked "Would you like a login shell to be accessible over serial?" and "Yes" when asked "Would you like the serial port hardware to be enabled?" You should see something like [Figure 3](#).

Figure 3. Enabling a serial UART using `raspi-config` on the Raspberry Pi.

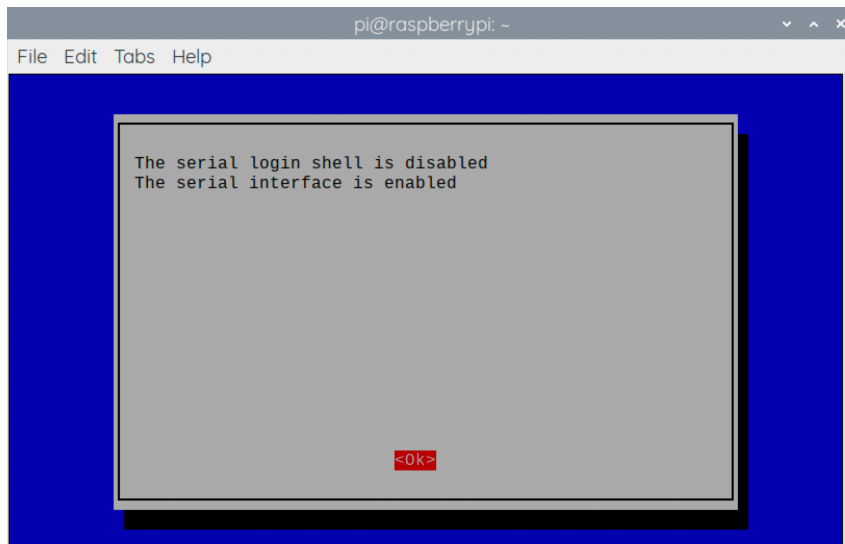

Leaving `raspi-config` you should choose "Yes" and reboot your Raspberry Pi to enable the serial port.

You should then wire the Raspberry Pi and the Raspberry Pi Pico together with the following mapping:

Raspberry Pi	Raspberry Pi Pico
GND (Pin 14)	GND (Pin 3)
GPIO15 (UART_RX0, Pin 10)	GP0 (UART0_TX, Pin 1)
GPIO14 (UART_TX0, Pin 8)	GP1 (UART0_RX, Pin 2)

See [Figure 4](#).

Figure 4. A Raspberry Pi 4 and the Raspberry Pi Pico with UART0 connected together.

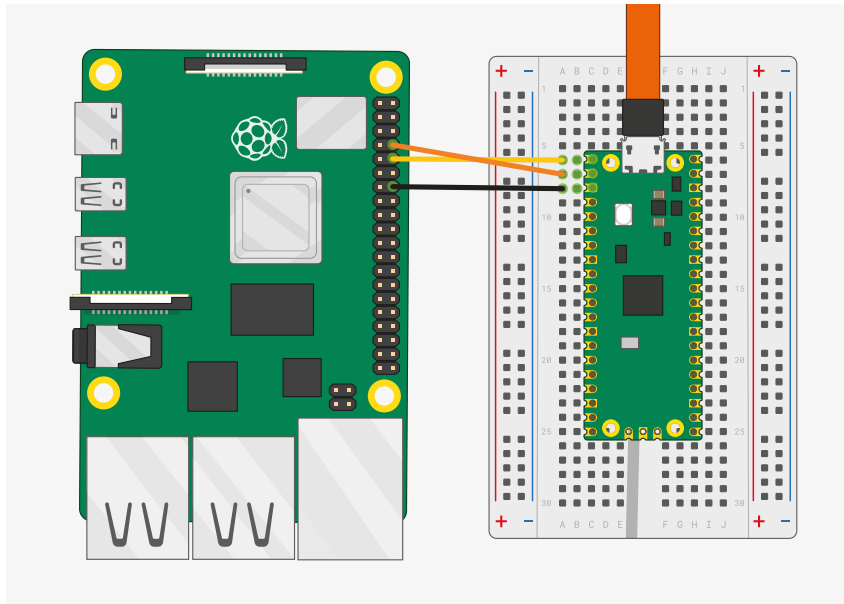

Once the two boards are wired together if you have not already done so you should install `minicom`:

```
$ sudo apt install minicom
```

and open the serial port:

```
$ minicom -b 115200 -o -D /dev/serial0
```

Toggling the power to Raspberry Pi Pico you should see `Hello, world!` printed to the console.

#### 💡 TIP

To exit `minicom`, use `CTRL-A` followed by `X`.

## 4.6. Powering the board

You can unplug the Raspberry Pi Pico from USB, and power the board by additionally connecting the Raspberry Pi's 5V pin to the Raspberry Pi Pico VSYS pin via a diode, see [Figure 5](#), where in the ideal case the diode would be a [Schottky diode](#).

Figure 5. Raspberry Pi and Raspberry Pi Pico connected only using the GPIO pins.

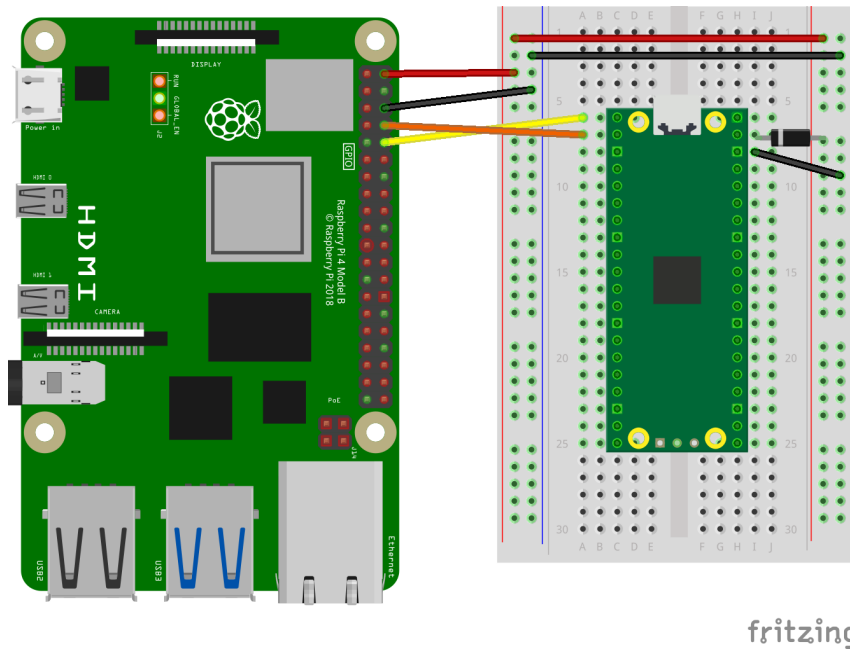

Whilst it is possible to connect the Raspberry Pi's 5V pin to the Raspberry Pi Pico VBUS pin, this is not recommended. Shorting the 5V rails together will mean that the Micro USB cannot be used. An exception is when using the Raspberry Pi Pico in USB host mode, in this case 5V must be connected to the VBUS pin.

The 3.3V pin is an OUTPUT pin on the Raspberry Pi Pico, you cannot power the Raspberry Pi Pico via this pin, and it should NOT be connected to a power source.

# Chapter 5. Debugging with SWD

## ! IMPORTANT

These instructions assume that you are using a Raspberry Pi Pico, details may differ if you are using an alternative RP2040-based board.

The Raspberry Pi Pico provides a SWD (Single Wire Debug) port which can be used to interactively debug a binary running on RP2040. However to use it you will first need build a special debug version of your binary and install some additional tools.

## 5.1. Build "Hello World" debug version

You can build a debug version of the "Hello World" with `CMAKE_BUILD_TYPE=Debug` as shown below,

```
$ cd ~/pico/pico-examples/  
$ rm -rf build  
$ mkdir build  
$ cd build  
$ export PICO_SDK_PATH=../../pico-sdk  
$ cmake -DCMAKE_BUILD_TYPE=Debug ..  
$ cd hello_world  
$ make -j4
```

## 5.2. Installing OpenOCD

OpenOCD is a debug translator: it allows a host system to load, run and debug software on RP2040, and to interactively poke and explore hardware registers. OpenOCD can attach to RP2040's SWD port via a number of hardware interfaces, including direct bitbanging from Raspberry Pi GPIOs.

The default configuration is to have SWDIO on Pi GPIO 24, and SWCLK on GPIO 25 – this can be wired to a Raspberry Pi Pico as seen in [Figure 6](#).



Figure 6. A Raspberry Pi 4 and the Raspberry Pi Pico with UART and SWD port connected together. Both are jumpered directly back to the Raspberry Pi 4 without using a breadboard.

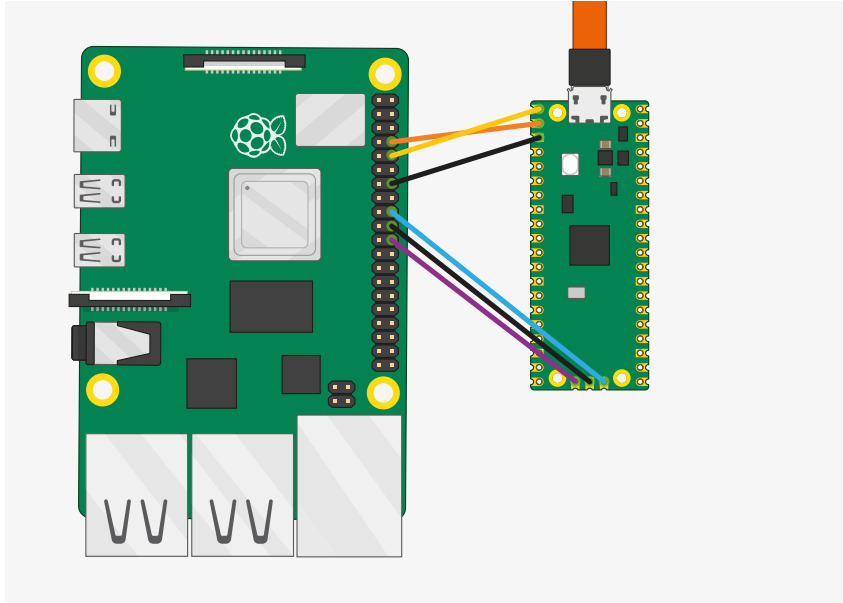

If possible you should wire the SWD port directly to the Raspberry Pi as signal integrity is important; wiring the SWD port via a breadboard or other indirect methods may reduce the signal integrity sufficiently so that loading code over the connection is erratic or fails completely. It is important to also wire the ground wire (0v) between the two directly and not rely on another ground path.

Note the Raspberry Pi Pico must also be powered (e.g. via USB) in order to debug it! You must build our OpenOCD branch to get working multidrop SWD support:

**NOTE**

These instructions assume you want to build openocd in `/home/pi/pico/openocd`

```
$ cd ~/pico
$ sudo apt install automake autoconf build-essential texinfo libtool libftdi-dev libusb-1.0-0-dev
$ git clone https://github.com/raspberrypi/openocd.git --recursive --branch rp2040 --depth=1
$ cd openocd
$ ./bootstrap
$ ./configure --enable-ftdi --enable-sysfsgpio --enable-bcm2835gpio
$ make -j4
$ sudo make install
```

## 5.3. Installing GDB

Install `gdb-multiarch`,

```
$ sudo apt install gdb-multiarch
```

## 5.4. Use GDB and OpenOCD to debug Hello World

Ensuring your Raspberry Pi 4 and Raspberry Pi Pico are correctly wired together, we can attach OpenOCD to the chip, via the `raspberrypi-swd` interface.

```
$ openocd -f interface/raspberrypi-swd.cfg -f target/rp2040.cfg
```

Your output should look like this:

```
...
Info : rp2040.core0: hardware has 4 breakpoints, 2 watchpoints
Info : rp2040.core1: hardware has 4 breakpoints, 2 watchpoints
Info : starting gdb server for rp2040.core0 on 3333
Info : Listening on port 3333 for gdb connections
```

### ⚠ WARNING

If you see an error like `Info : DAP init failed` then your Raspberry Pi Pico is either powered off, wired incorrectly, or has signal integrity issues. Try different GPIO jumper cables.

This OpenOCD terminal needs to be left open. So go ahead and open another terminal, in this one we'll attach a gdb instance to OpenOCD. Navigate to the "Hello World" example code, and start `gdb` from the command line.

```
$ cd ~/pico/pico-examples/build/hello_world
$ gdb-multiarch hello_world.elf
```

Connect GDB to OpenOCD,

```
(gdb) target remote localhost:3333
```

### 💡 TIP

You can create a `.gdbinit` file so you don't have to type `target remote localhost:3333` every time. Do this with `echo "target remote localhost:3333" > ~/.gdbinit`. However, this interferes with debugging in VSCode ([Chapter 6](#)).

and load `hello_world.elf` into flash,

```
(gdb) load
Loading section .boot2, size 0x100 lma 0x10000000
Loading section .text, size 0x22d0 lma 0x10000100
Loading section .rodata, size 0x4a0 lma 0x100023d0
Loading section .ARM.exidx, size 0x8 lma 0x10002870
Loading section .data, size 0xb94 lma 0x10002878
Start address 0x10000104, load size 13324
Transfer rate: 31 KB/sec, 2664 bytes/write.
```

and then start it running.

```
(gdb) monitor reset init
(gdb) continue
```

### ! IMPORTANT

If you see errors similar to `Error finishing flash operation` or `Error erasing flash with vFlashErase packet` in GDB when attempting to load the binary onto the Raspberry Pi Pico via OpenOCD then there is likely poor signal integrity between the Raspberry Pi and the Raspberry Pi Pico. If you are not directly connecting the SWD connection between the two boards, see [Figure 6](#), you should try to do that. Alternatively you can try reducing the value of `adapter_khz` in the `raspberrypi-swd.cfg` configuration file, trying halving it until you see a successful connection between the boards. As we're bitbanging between the boards timing is marginal, so poor signal integrity may cause errors.

Or if you want to set a breakpoint at `main()` before running the executable,

```
(gdb) monitor reset init
(gdb) b main
(gdb) continue

Thread 1 hit Breakpoint 1, main () at /home/pi/pico/pico-examples/hello_world/hello_world.c:11
11      setup_standard_uart();
```

before continuing after you have hit the breakpoint,

```
(gdb) continue
```

To quit from `gdb` type,

```
(gdb) quit
```

# Chapter 6. Using Visual Studio Code

Visual Studio Code (VSCode) is a popular open source editor developed by Microsoft. It is the recommended Integrated Development Environment (IDE) on the Raspberry Pi 4 if you want a graphical interface to edit and debug your code.

## 6.1. Installing Visual Studio Code

### ! IMPORTANT

These installation instructions rely on you already having downloaded and installed the command line toolchain, see [Chapter 3](#), as well as downloading and building both OpenOCD and GDB and configuring them for command line debugging, see [Chapter 5](#).

ARM versions of Visual Studio Code for the Raspberry Pi can be downloaded from <https://code.visualstudio.com/Download>. If you are using a 32-bit operating system (e.g. the default Raspberry Pi OS) then download the **ARM .deb** file; if you are using a 64-bit OS, then download the **ARM 64 .deb** file. Once downloaded, double click on the .deb package and follow the instructions to install it.

Install the downloaded .deb. package from the command line. `cd` to the folder where the file was downloaded, then use `dpkg -i <downloaded file name.deb>` to install.

Once the install has completed, install the extensions needed to debug a Raspberry Pi Pico:

```
code --install-extension marus25.cortex-debug
code --install-extension ms-vscode.cmake-tools
code --install-extension ms-vscode.cpptools
```

Finally, start Visual Studio Code from a Terminal window:

```
$ export PICO_SDK_PATH=/home/pi/pico/pico-sdk
$ code
```

Ensure you set the `PICO_SDK_PATH` so that Visual Studio Code can find the Pico SDK.

### i NOTE

If `PICO_SDK_PATH` is not set by default in your shell's environment you will have to set it each time you open a new Terminal window before starting `vscode`, or start `vscode` from the menus. You may therefore want to add it to your `.profile` or `.bashrc` file.

## 6.2. Loading a Project

Go ahead and open the `pico-examples` folder by going to the Explorer toolbar (`Ctrl + Shift + E`), selecting "Open Folder," and navigating to, `/home/pi/pico/pico-examples` in the file popup. Then click "OK" to load the Folder into VSCode.

As long as the [CMake Tools](#) extension is installed, after a second or so you should see a popup in the lower right-hand corner of the `vscode` window.

Hit "Yes" to configure the project. You will then be prompted to choose a compiler, see [Figure 7](#),

Figure 7. Prompt to choose the correct compiler for the project.

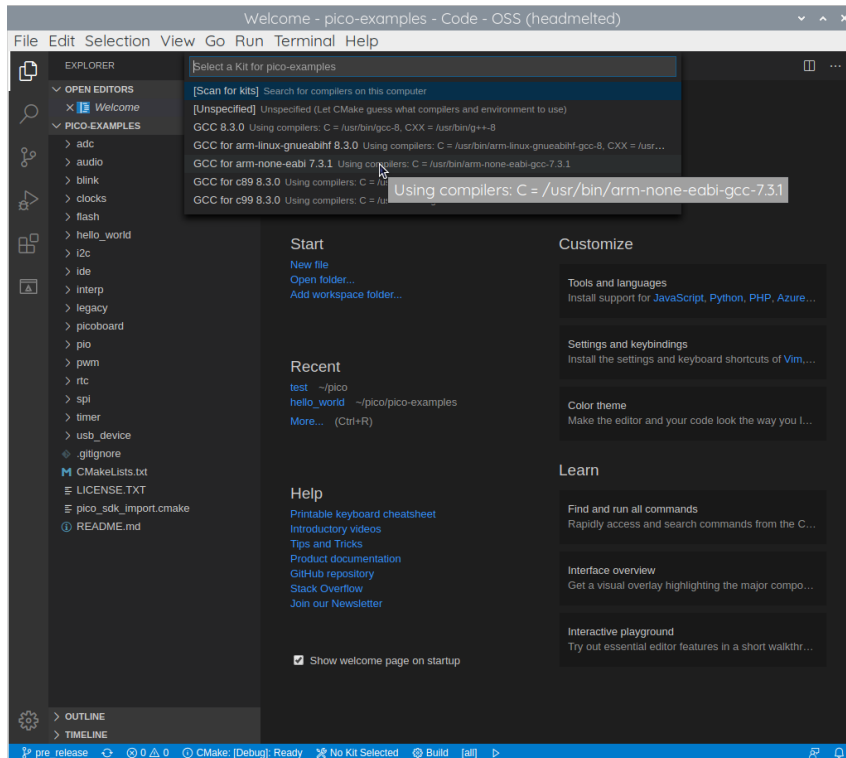

and you should select **GCC for arm-none-eabi** from the drop down menu.

#### **TIP**

If you miss the popups, which will close again after a few seconds, you can configure the compiler by clicking on "No Kit Selected" in the blue bottom bar of the VSCode window.

You can then either click on the "Build" button in the blue bottom bar to build all of the examples in `pico-examples` folder, or click on where it says "[all]" in the blue bottom bar. This will present you with a drop down where you can select a project. For now type in "hello\_world" and select the "Hello World" executable. This means that VSCode will only build the "Hello World" example saving compile time.

#### **TIP**

You can toggle between building "Debug" and "Release" executables by clicking on where it says "CMake: [Debug]: Ready" in the blue bottom bar. The default is to build a "Debug" enabled executable ready for SWD debugging.

Go ahead and click on the "Build" button (with a cog wheel) in the blue bottom bar of the window. This will create the build directory and run CMake as we did by hand in [Section 3.1](#), before starting the build itself, see [Figure 8](#).

Figure 8. Building the `pico-examples` project in Visual Studio Code

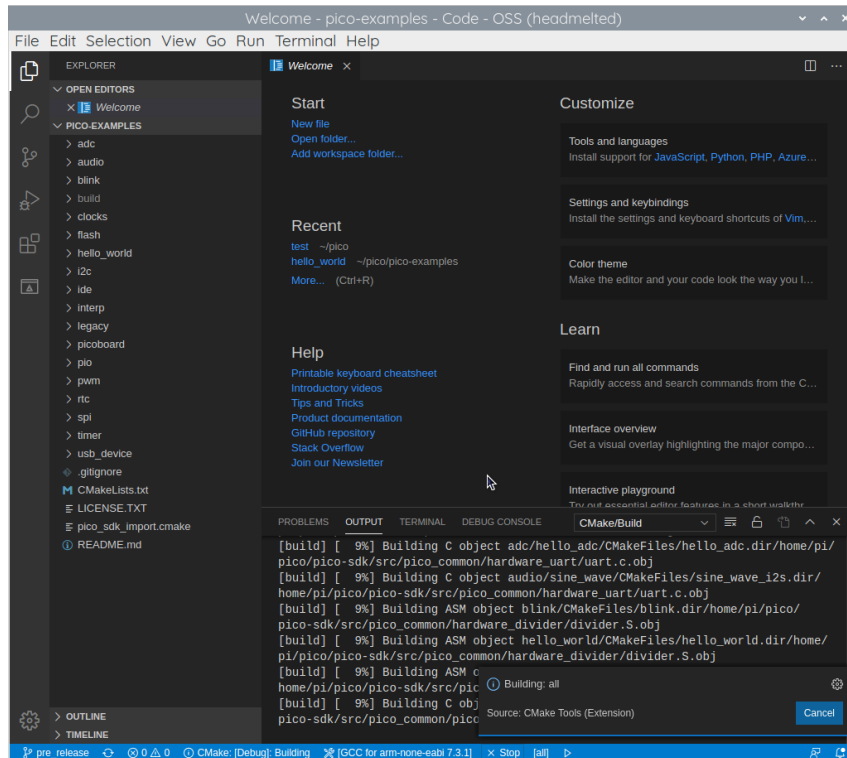

As we did from the command line previously, amongst other targets, we have now built:

- `hello_world.elf`, which is used by the debugger
- `hello_world.uf2`, which can be dragged onto the RP2040 USB Mass Storage Device

## 6.3. Debugging a Project

The `pico-examples` repo contains an example debug configuration that will start OpenOCD, attach GDB, and finally launch the application CMake is configured to build. Go ahead and copy this file (`launch-raspberrypi-swd.json`) into the `pico-examples/.vscode` directory as `launch.json`. We also provide a `settings.json` file that we recommend you also copy. This `settings.json` removes some potentially confusing options from the CMake plugin (including a broken Debug and Run buttons that attempt to run a Pico binary on the host).

```
$ cd ~/pico/pico-examples
$ mkdir .vscode
$ cp ide/vscode/launch-raspberrypi-swd.json .vscode/launch.json
$ cp ide/vscode/launch-raspberrypi-swd.json .vscode/settings.json
```

Pico Examples: <https://github.com/raspberrypi/pico-examples/tree/master/ide/vscode/launch-raspberrypi-swd.json> Lines 1 - 27

```
1 {
2   "version": "0.2.0",
3   "configurations": [
4     {
5       "name": "Pico Debug",
6       "cwd": "${workspaceRoot}",
7       "executable": "${command:cmake.launchTargetPath}",
8       "request": "launch",
9       "type": "cortex-debug",
10      "servertype": "openocd",
```

```

11 // This may need to be arm-none-eabi-gdb depending on your system
12 "gdbpath" : "gdb-multiarch",
13 "device" : "RP2040",
14 "configFiles": [
15     "interface/raspberrypi-swd.cfg",
16     "target/rp2040.cfg"
17 ],
18 "svdFile": "/home/pi/pico/pico-sdk/src/rp2040/hardware_regs/rp2040.svd",
19 "runToMain": true,
20 // Work around for stopping at main on restart
21 "postRestartCommands": [
22     "break main",
23     "continue"
24 ]
25 }
26 ]
27 }

```

### NOTE

You may have to amend the `gdbpath` in `launch.json` if your gdb is called `arm-none-eabi-gdb` instead of `gdb-multiarch`

## 6.3.1. Running "Hello World" on the Raspberry Pi Pico

### IMPORTANT

Ensure that the example "Hello World" code has been as a Debug binary (`CMAKE_BUILD_TYPE=Debug`).

Now go to the Debug toolbar (**Ctrl + Shift + D**) and click the small green arrow (play button) at the top of the left-hand window pane to load your code on the Raspberry Pi Pico and start debugging.

Figure 9. Debugging the "Hello World" binary inside Visual Studio Code

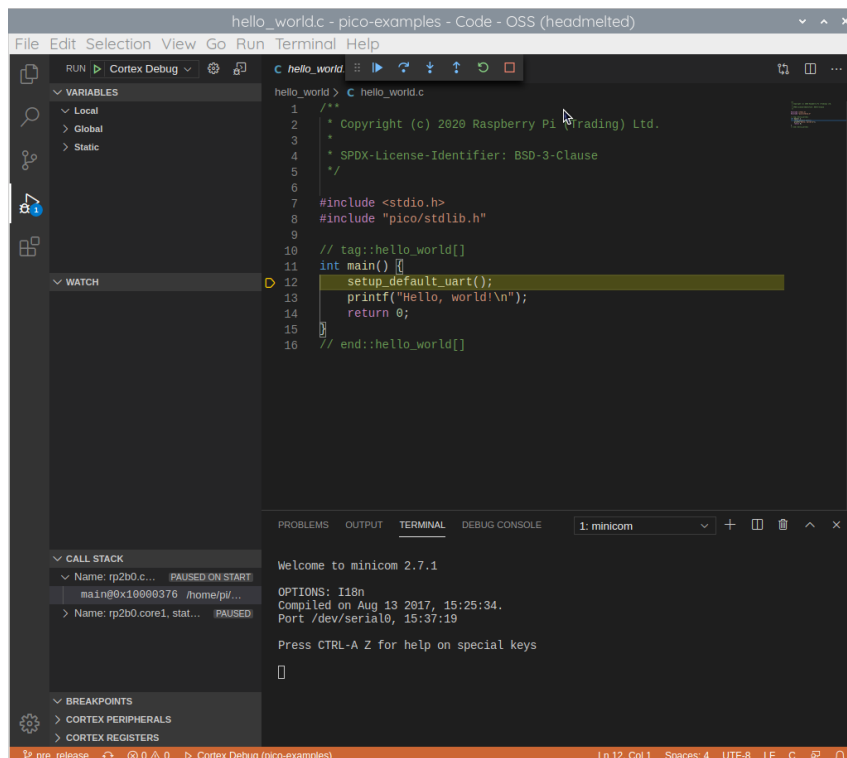

The code should now be loaded and on to the Raspberry Pi Pico, and you should see the source code for "Hello World" in the main right-hand (upper) pane of the window. The code will start to run and it will proceed to the first breakpoint – enabled by the `runToMain` directive in the `launch.json` file. Click on the small blue arrow (play button) at the top of this main source code window to Continue (F5) and start the code running.

 **TIP**

If you switch to the "Terminal" tab in the bottom right-hand pane, below the `hello_world.c` code, you can use this to open `minicom` inside VSCode to see the UART output from the "Hello World" example by typing,

```
$ minicom -b 115200 -o -D /dev/serial0
```

at the terminal prompt as we did before, see [Section 4.5](#).



# Chapter 7. Creating your own Project

Go ahead and create a directory to house your test project sitting alongside the `pico-sdk` directory,

```
$ ls -la
total 16
drwxr-xr-x  7 aa  staff   224  6 Apr 10:41 ./
drwx-----@ 27 aa  staff   864  6 Apr 10:41 ../
drwxr-xr-x 10 aa  staff   320  6 Apr 09:29 pico-examples/
drwxr-xr-x 13 aa  staff   416  6 Apr 09:22 pico-sdk/
$ mkdir test
$ cd test
```

and then create a `test.c` file in the directory,

```
1 #include <stdio.h>
2 #include "pico/stdlib.h"
3 #include "hardware/gpio.h"
4 #include "pico/binary_info.h"
5
6 const uint LED_PIN = 25;
7
8 int main() {
9
10     bi_decl(bi_program_description("This is a test binary.));①
11     bi_decl(bi_1pin_with_name(LED_PIN, "On-board LED"));
12
13     stdio_init_all();
14
15     gpio_init(LED_PIN);
16     gpio_set_dir(LED_PIN, GPIO_OUT);
17     while (1) {
18         gpio_put(LED_PIN, 0);
19         sleep_ms(250);
20         gpio_put(LED_PIN, 1);
21         puts("Hello World\n");
22         sleep_ms(1000);
23     }
24 }
```

① These lines will add strings to the binary visible using `picotool`, see [Appendix B](#).

along with a `CMakeLists.txt` file,

```
cmake_minimum_required(VERSION 3.12)

include(pico_sdk_import.cmake)

project(test_project)

pico_sdk_init()

add_executable(test
    test.c
)

pico_enable_stdio_usb(test 1)①
```

```
pico_enable_stdio_uart(test 1)②

pico_add_extra_outputs(test)

target_link_libraries(test pico_stdlib)
```

1. This will enable serial output via USB.
2. This will enable serial output via UART.

Then copy the `pico_sdk_import.cmake` file from the `external` folder in your `pico-sdk` installation to your test project folder.

```
$ cp ../pico-sdk/external/pico_sdk_import.cmake .
```

You should now have something that looks like this,

```
$ ls -la
total 24
drwxr-xr-x  5 aa  staff   160  6 Apr 10:46 ./
drwxr-xr-x  7 aa  staff   224  6 Apr 10:41 ../
-rw-r--r--@ 1 aa  staff   394  6 Apr 10:37 CMakeLists.txt
-rw-r--r--  1 aa  staff  2744  6 Apr 10:40 pico_sdk_import.cmake
-rw-r--r--  1 aa  staff   383  6 Apr 10:37 test.c
```

and can build it as we did before with our "Hello World" example.

```
$ mkdir build
$ cd build
$ export PICO_SDK_PATH=../pico-sdk
$ cmake ..
$ make
```

The make process will produce a number of different files. The important ones are shown in the following table.

File extension	Description
.bin	Raw binary dump of the program code and data
.elf	The full program output, possibly including debug information
.uf2	The program code and data in a UF2 form that you can drag-and-drop on to the RP2040 board when it is mounted as a USB drive
.dis	A disassembly of the compiled binary
.hex	Hexdump of the compiled binary
.map	A map file to accompany the .elf file describing where the linker has arranged segments in memory

**NOTE**

UF2 (USB Flashing Format) is a file format, developed by Microsoft, that is used for flashing the RP2040 board over USB. More details can be found on the [Microsoft UF2 Specification Repo](#)

**NOTE**

To build a binary to run in SRAM, rather than Flash memory you can either setup your `cmake` build with `-DPICO_NO_FLASH=1` or you can add `pico_set_binary_type(TARGET_NAME no_flash)` to control it on a per binary basis in your `CMakeLists.txt` file. You can download the RAM binary to RP2040 via UF2. For example, if there is no flash chip on your board, you can download a binary that runs on the on-chip RAM using UF2 as it simply specifies the addresses of where data goes. Note you can only download in to RAM or FLASH, not both.

## 7.1. Debugging your project

Debugging your own project from the command line follows the same processes as we used for the "Hello World" example back in [Section 5.4](#). Connect your Raspberry Pi and the Raspberry Pi Pico as in [Figure 10](#).

Figure 10. A Raspberry Pi 4 and the Raspberry Pi Pico with UART and SWD debug port connected together. Both are jumpered directly back to the Raspberry Pi 4 without using a breadboard.

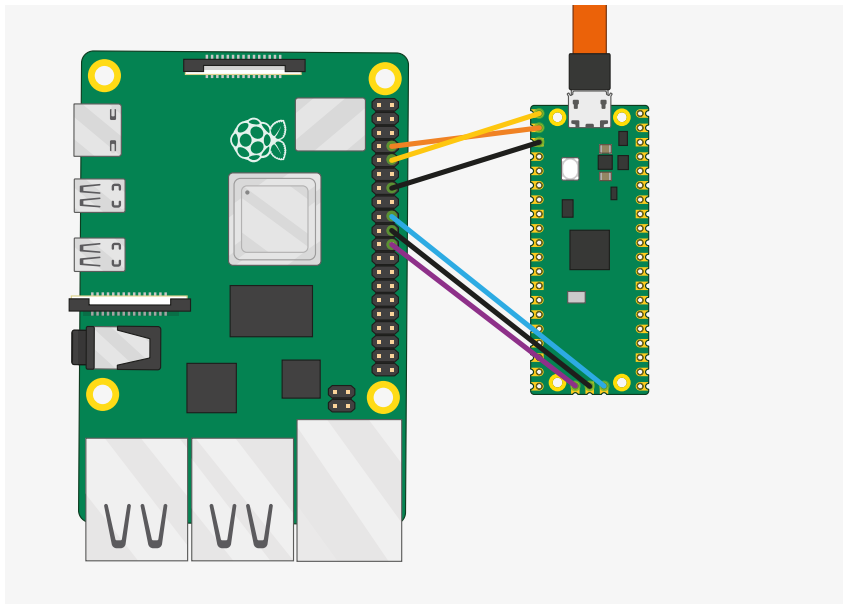

Then go ahead and build a debug version of your project using `CMAKE_BUILD_TYPE=Debug` as below,

```
$ cd ~/pico/test
$ rmdir build
$ mkdir build
$ cd build
$ export PICO_SDK_PATH=../../pico-sdk
$ cmake -DCMAKE_BUILD_TYPE=Debug ..
$ make
```

Then open up a terminal window and attach OpenOCD using the `raspberrypi-swd` interface.

```
$ openocd -f interface/raspberrypi-swd.cfg -f target/rp2040.cfg
```

This OpenOCD terminal needs to be left open. So go ahead and open another terminal window and start `gdb-multiarch` using

```
$ cd ~/pico/test/build
$ gdb-multiarch test.elf
```

Connect GDB to OpenOCD, and load the `test.elf` binary into flash,

```
(gdb) target remote localhost:3333
(gdb) load
```

and then start it running,

```
(gdb) monitor reset init
(gdb) continue
```

## 7.2. Working in Visual Studio Code

If you want to work in Visual Studio Code rather than from the command line you can do that, see [Chapter 6](#) for instructions on how to configure the environment and load your new project into the development environment to let you write and build code.

If you want to also use Visual Studio Code to debug and load your code onto the Raspberry Pi Pico you'll need to create a `launch.json` file for your project. The example `launch-raspberrypi-swd.json` in [Chapter 6](#) should work. You need to copy it into your project directory as `.vscode/launch.json`.

## 7.3. Automating project creation

Some automation has been created which will automatically create a "stub" project with all the necessary files to allow it to build. If you want to make use of this you'll need to go ahead and clone the project creation script from its Git repository,

```
$ git clone https://github.com/raspberrypi/pico-project-generator.git
```

It can then be run in graphical mode,

```
$ cd pico-project-generator
$ ./pico_project.py --gui
```

which will bring up a GUI interface allowing you to configure your project, see [Figure 11](#).

Figure 11. Creating a RP2040 project using the graphical project creation tool.

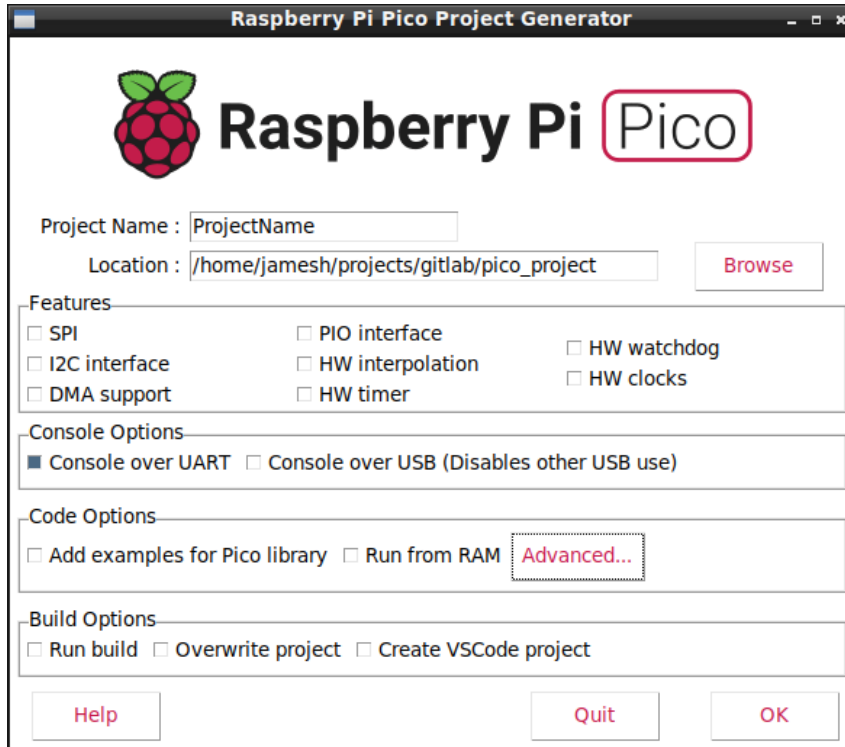

You can add specific features to your project by selecting them from the check boxes on the GUI. This will ensure the build system adds the appropriate code to the build, and also adds simple example code to the project showing how to use the feature.

There are a number of options available, which provide the following functionality.

Console Options	Description
Console over UART	Enable a serial console over the UART. This is the default.
Console over USB	Enable a console over the USB. The device will act as a USB serial port. This can be used in addition to or instead of the UART option, but note that when enabled other USB functionality is not possible.

Code Options	Description
Add examples for Pico library	Example code will be generated for some of the standard library features that by default are in the build, for example, UART support and HW dividers.
Run from RAM	Usually, the build creates a binary that will be installed to the flash memory. This forces the binary to work directly from RAM
Advanced	Brings up a table allowing selection of specific board build options. These options alter the way the features work, and should be used with caution.

Build Options	Description
Run Build	Once the project has been created, build it. This will produce files ready for download to the Raspberry Pi Pico.
Overwrite Project	If a project already exists in the specified folder, overwrite it with the new project. This will overwrite any changes you may have made.
Create VSCode Project	As well as the CMake files, also create the appropriate Visual Studio Code project files.

### 7.3.1. Project generation from the command line

The script also provides the ability to create a project from the command line, e.g.

```
$ export PICO_SDK_PATH="/home/pi/pico/pico-sdk"  
$ ./pico_project.py --feature spi --feature i2c --project vscode test
```

The `--feature` options add the appropriate library code to the build, and also example code to show basic usage of the feature. You can add multiple features, up to the memory limitation of the RP2040. You can use the `--list` option of the script to list all the available features. The example above adds support for the I2C and SPI interfaces.

Here passing the `--project` option will mean that at `.vscode/launch.json`, `.vscode/c_cpp_properties.json`, and `.vscode/settings.json` files are also created in addition to the CMake project files.

Once created you can build the project in the normal way from the command line,

```
$ cd test/build  
$ cmake ..  
$ make
```

or from Visual Studio code.

You can use the `--help` option to give a list of command line arguments, these will also be applied when using the graphical mode.

#### Need more detail?

There should be enough here to show you *how* to get started, but you may find yourself wondering *why* some of these files and incantations are needed. The [Pico C/C++ SDK](#) book dives deeper into how your project is actually built, and how the lines in our `CMakeLists.txt` files here relate to the structure of the SDK, if you find yourself wanting to know more at some future point.

# Chapter 8. Building on other platforms

While the main supported platform for developing for the RP2040 is the Raspberry Pi, support for other platforms, such as Apple macOS and Microsoft Windows, is available.

## 8.1. Building on Apple macOS

Using macOS to build code for RP2040 is very similar to Linux.

### 8.1.1. Installing the Toolchain

Installation depends on Homebrew, if you don't have [Homebrew](#) installed you should go ahead and install it,

```
$ /bin/bash -c "$(curl -fsSL
https://raw.githubusercontent.com/Homebrew/install/master/install.sh)"
```

Then install the toolchain,

```
$ brew install cmake
$ brew tap ArmMbed/homebrew-formulae
$ brew install arm-none-eabi-gcc
```

However after that you can follow the Raspberry Pi instructions to build code for the RP2040. Once the toolchain is installed there are no differences between macOS and Linux to, so see [Section 2.1](#) and follow the instructions from there to fetch the Pico SDK and build the "Blink" example.

### 8.1.2. Using Visual Studio Code

The Visual Studio Code (VSCode) is a cross platform environment and runs on macOS, as well as Linux, and Microsoft Windows. Go ahead and [download the macOS version](#), unzip it, and drag it to your Applications Folder.

Navigate to Applications and click on the icon to start Visual Studio Code.

### 8.1.3. Building with CMake Tools

After starting Visual Studio Code you then need to install the [CMake Tools](#) extension. Click on the Extensions icon in the left-hand toolbar (or type **Cmd + Shift + X**), and search for "CMake Tools" and click on the entry in the list, and then click on the install button.

We now need to set the `PICO_SDK_PATH` environment variable. Navigate to the `pico-examples` directory and create a `.vscode` directory and add a file called `settings.json` to tell CMake Tools to location of the Pico SDK.

```
{
  "cmake.environment": {
    "PICO_SDK_PATH": "../../pico-sdk"
```

```

    },
}

```

Now go to the File menu and click on "Add Folder to Workspace..." and navigate to `pico-examples` repo and hit "Okay". The project will load and you'll (probably) be prompted to choose a compiler, see [Figure 12](#). Select "GCC for arm-none-eabi" for your compiler.

Figure 12. Prompt to choose the correct compiler for the project.

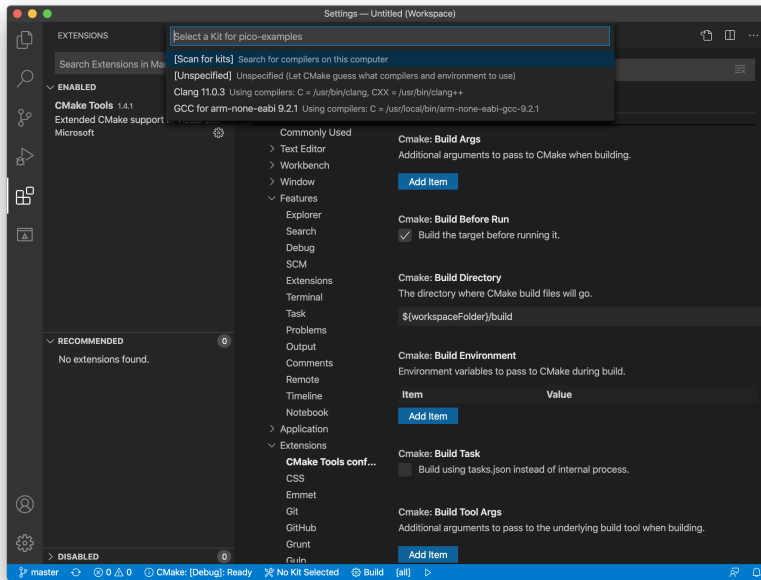

Go ahead and click on the "Build" button (with a cog wheel) in the blue bottom bar of the window. This will create the build directory and run CMake as we did by hand in [Section 3.1](#), before starting the build itself, see [Figure 8](#).

This will produce ELF, `bin`, and `uf2` targets, you can find these in the `hello_world` directory inside the newly created `build` directory. The UF2 binary can be dragged-and-dropped directly onto a RP2040 board attached to your computer using USB.

## 8.1.4. Saying "Hello World"

As we did previously in [Chapter 4](#) you can build the Hello World example with `stdio` routed either to USB CDC (Serial) or to UART0 on pins GP0 and GP1. No driver installation is necessary if you're building with USB CDC as the target output as its a class compliant device. You just need to use a Terminal program, e.g. [Serial](#) or similar, to connect to the USB serial port.

### 8.1.4.1. UART output

Alternatively if you want to you want to connect to the Raspberry Pi Pico standard UART to see the output you will need to connect your Raspberry Pi Pico to your Mac using a USB to UART Serial converter, for example a [SparkFun FTDI Basic](#) board, see [Figure 13](#).



Figure 13. Sparkfun FTDI Basic adaptor connected to the Raspberry Pi Pico

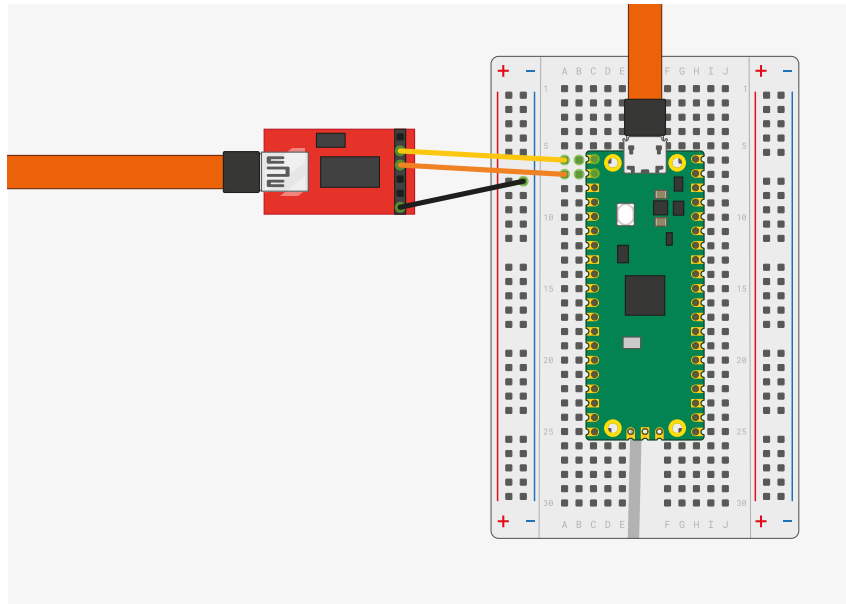

So long as you're using a recent version of macOS like Catalina, the drivers should already be loaded. Otherwise see the manufacturers' website for [FTDI Chip Drivers](#).

Then you should use a Terminal program, e.g. [Serial](#) or similar to connect to the serial port. Serial also includes [driver support](#).

## 8.2. Building on MS Windows

Installing the toolchain on Microsoft Windows is somewhat different to other platforms. However once installed building code for the RP2040 is somewhat similar.

### 8.2.1. Installing the Toolchain

To build you will need to install some extra tools.

- [ARM GCC compiler](#)
- [CMake](#)
- [Build Tools for Visual Studio 2019](#)
- [Python 3](#)
- [Git](#)

Download the executable installer for each of these, and then go ahead and install all five packages on to your Windows machine.

#### 8.2.1.1. Installing ARM GCC Compiler

Figure 14. Installing the needed tools to your Windows machine. Ensure that you register the path to the compiler as an environment variable so that it accessible from the command line.

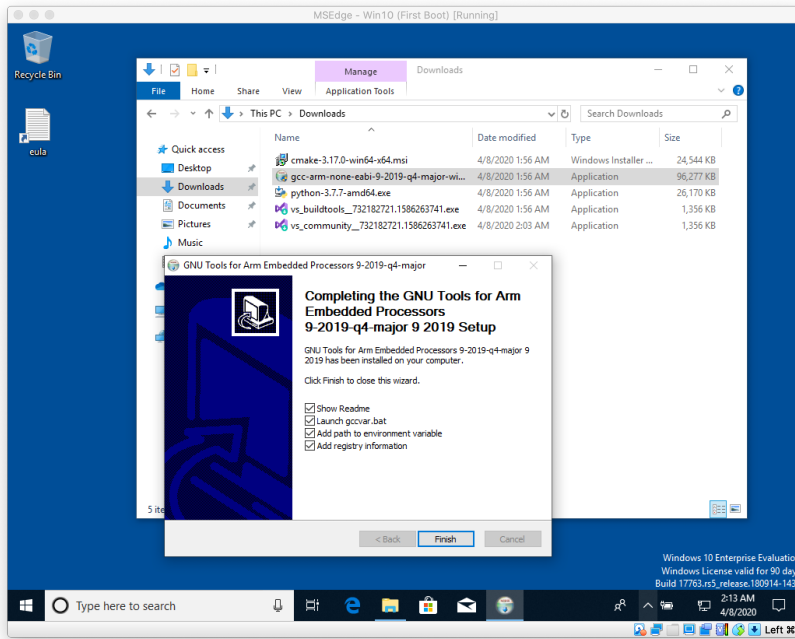

During installation you should tick the box to register the path to the ARM compiler as an environment variable in the Windows shell when prompted to do so.

### 8.2.1.2. Installing CMake

During the installation add CMake to the system PATH for all users when prompted by the installer.

### 8.2.1.3. Installing Visual Studio Code

Figure 15. Installing the Build Tools for Visual Studio 2019.

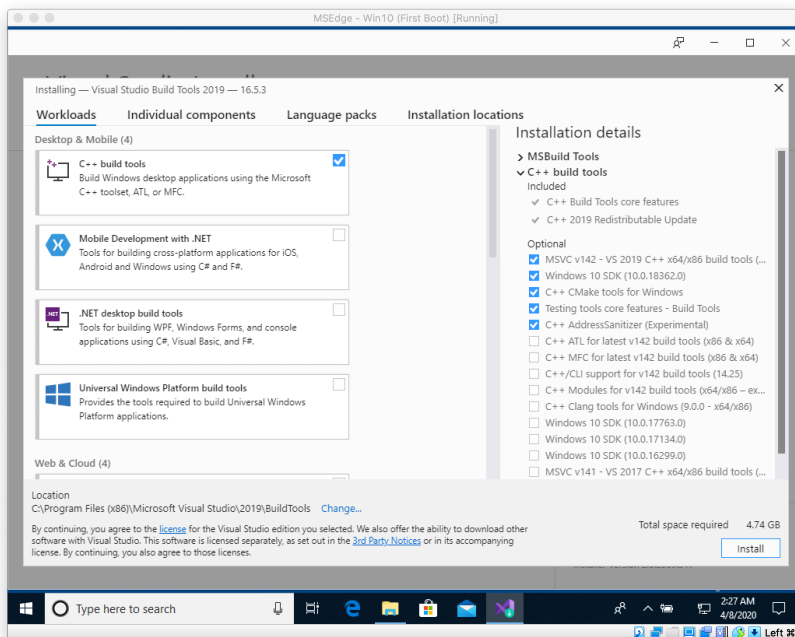

When prompted by the Build Tools for Visual Studio installer you need to install the C++ build tools only.

### 8.2.1.4. Installing Python 3

During the installation add Python 3.7 to the system `PATH` for all users when prompted by their installers. You should additionally disable the `MAX_PATH` length when prompted at the end of the Python installation.

Figure 16. Installing Python 3.7 tick the "Install for all users" box under Advanced Options.

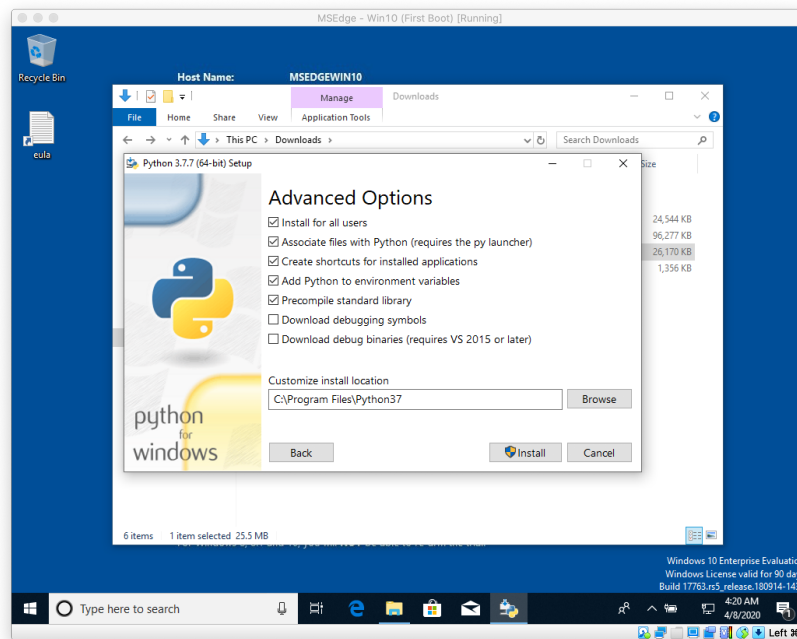

Additionally, when installing Python chose 'Customize installation,' click through 'Optional Features' and then under 'Advanced Features' choose to 'Install for all users'.

#### **NOTE**

You may have to make a symbolic link so that the Makefile can find Python 3. To do so type `cmd` in the Run Window next to the Windows Menu to open a Developer Command Prompt Window but select "Run as administrator" in the right hand pane to open the window with administrative privileges. Then navigate to `C:\Program Files\Python37` and make a symlink.

```
C:\Program Files\Python37> mklink python3.exe python.exe
```

This **should** no longer be necessary. However if your build fails because make can't find your Python installation you should add the symlink to the executable. That may resolve things.

### 8.2.1.5. Installing Git

When installing Git you should ensure that you change the default editor away from `vim`, see [Figure 17](#).

Figure 17. Installing Git

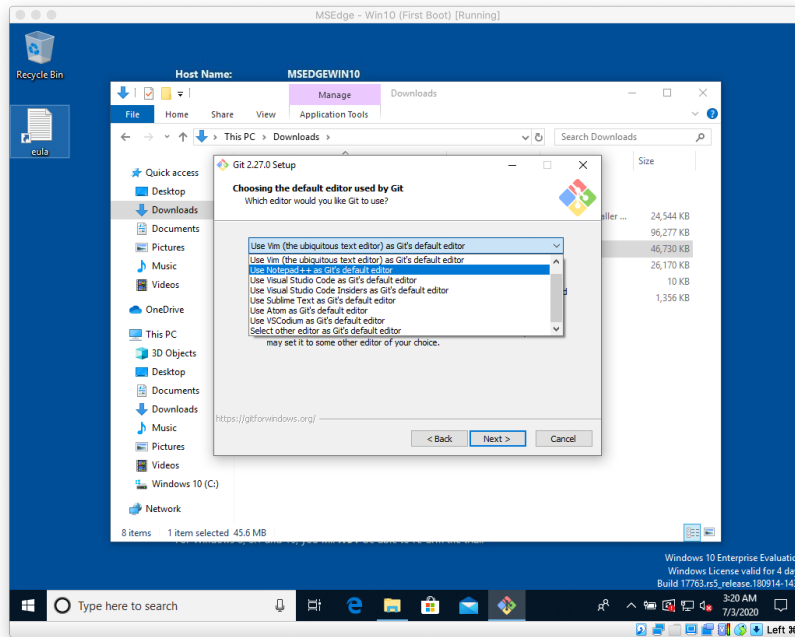

Ensure you tick the checkbox to allow Git to be used from third-party tools and, unless you have a strong reason otherwise, when installing Git you should also check the box "Checkout as is, commit as-is", select "Use Windows' default console window", and "Enable experimental support for pseudo consoles" during the installation process.

### 8.2.2. Getting the Pico SDK and examples

```
C:\Users\pico\Downloads> git clone -b master https://github.com/raspberrypi/pico-sdk.git
C:\Users\pico\Downloads> cd pico-sdk
C:\Users\pico\Downloads\pico-sdk> git submodule update --init
C:\Users\pico\Downloads\pico-sdk> cd ..
C:\Users\pico\Downloads> git clone -b master https://github.com/raspberrypi/pico-examples.git
```

### 8.2.3. Building "Hello World" from the Command Line

Go ahead and open a Developer Command Prompt Window from the Windows Menu, by selecting **Windows > Visual Studio 2019 > Developer Command Prompt** from the menu.

Then set the path to the Pico SDK as follows,

```
C:\Users\pico\Downloads> setx PICO_SDK_PATH "..\..\pico-sdk"
```

You now need **close your current Command Prompt Window** and open a second Command Prompt Window where this environment variable will now be set correctly before proceeding.

Navigate into the **pico-examples** folder, and build the 'Hello World' example as follows,

```
C:\Users\pico\Downloads> cd pico-examples
C:\Users\pico\Downloads\pico-examples> mkdir build
C:\Users\pico\Downloads\pico-examples> cd build
C:\Users\pico\Downloads\pico-examples\build> cmake -G "NMake Makefiles" ..
```

```
C:\Users\pico\Downloads\pico-examples\build> nmake
```

to build the target. This will produce ELF, `bin`, and `uf2` targets, you can find these in the `hello_world` directory inside your `build` directory. The UF2 binary can be dragged-and-dropped directly onto a RP2040 board attached to your computer using USB.

## 8.2.4. Building "Hello World" from Visual Studio Code

Now you've installed the toolchain you can install [Visual Studio Code](#) and build your projects inside the that environment rather than from the command line.

Go ahead and [download](#) and install Visual Studio Code for Windows. After installation open a Developer Command Prompt Window from the Windows Menu, by selecting `Windows > Visual Studio 2019 > Developer Command Prompt` from the menu. Then type,

```
C:> code
```

at the prompt. This will open Visual Studio Code with all the correct environment variables set so that the toolchain is correctly configured.

### ⚠ WARNING

If you start Visual Studio code by clicking on its desktop icon, or directly from the Start Menu then the build environment will **not** be correctly configured. Although this can be done manually later in the CMake Tools Settings, the easiest way to configure the Visual Studio Code environment is just to open it from a Developer Command Prompt Window where these environmental variables are already set.

We'll now need to install the [CMake Tools](#) extension. Click on the Extensions icon in the left-hand toolbar (or type `Ctrl + Shift + X`), and search for "CMake Tools" and click on the entry in the list, and then click on the install button.

Then click on the Cog Wheel at the bottom of the navigation bar on the left-hand side of the interface and select "Settings". Then in the Settings pane click on "Extensions" and the "CMake Tools configuration". Then scroll down to "Cmake: Configure Environment". Click on "Add Item" and add set the `PICO_SDK_PATH` to be `..\..\pico-sdk` as in [Figure 18](#).

Figure 18. Setting `PICO_SDK_PATH` Environment Variable in the CMake Extension

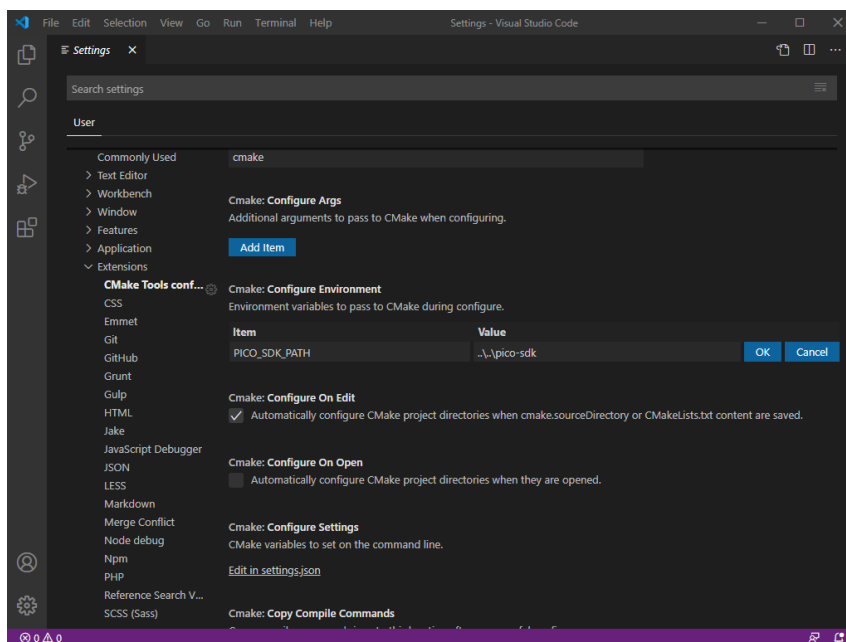

Now go to the File menu and click on "Open Folder" and navigate to `pico-examples` repo and hit "Okay". You'll be prompted to configure the project, see [Figure 19](#). Select "GCC for arm-none-eabi" for your compiler.

Figure 19. Prompt to configure your project in Visual Studio Code.

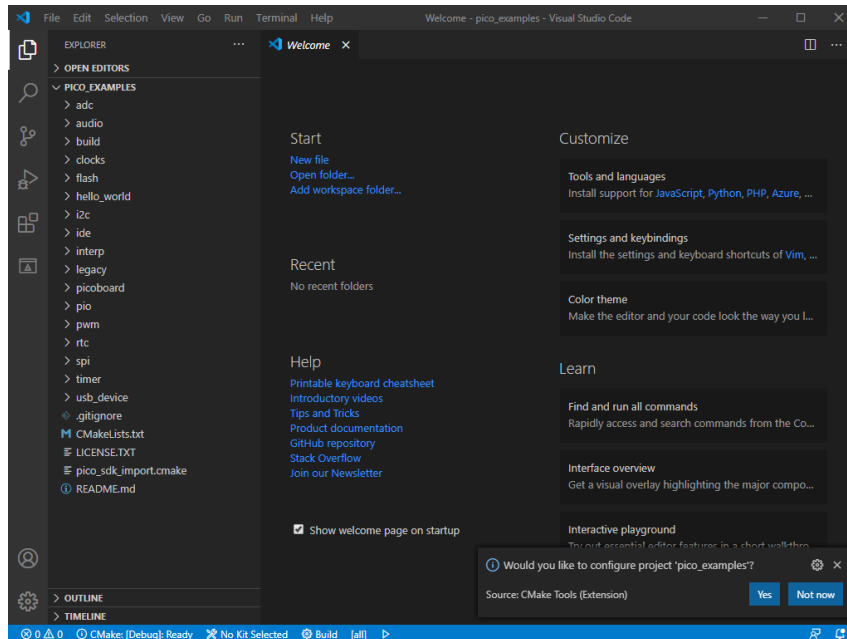

Go ahead and click on the "Build" button (with a cog wheel) in the blue bottom bar of the window. This will create the build directory and run CMake and build the examples project, including "Hello World".

This will produce ELF, `bin`, and `uf2` targets, you can find these in the `hello_world` directory inside the newly created `build` directory. The UF2 binary can be dragged-and-dropped directly onto a RP2040 board attached to your computer using USB.

## 8.2.5. Flashing and Running "Hello World"

Connect the Raspberry Pi Pico to your Raspberry Pi using a micro-USB cable, making sure that you hold down the `BOOTSEL` button to force it into USB Mass Storage Mode. The board should automatically appear as an external drive. You can now drag-and-drop the UF2 binary onto the external drive.

The Raspberry Pi Pico will reboot, and unmount itself as an external drive, and start running the flashed code.

As we did in [Chapter 4](#) you can build the Hello World example with `stdio` routed either to USB CDC (Serial) or to UART0 on pins GP0 and GP1. No driver installation is necessary if you're building with USB CDC as the target output as its a class compliant device.

### 8.2.5.1. UART output

Alternatively if you want to you want to connect to the Raspberry Pi Pico standard UART to see the output you will need to connect your Raspberry Pi Pico to your Mac using a USB to UART Serial converter, for example a [SparkFun FTDI Basic](#) board, see [Figure 13](#).

Figure 20. Sparkfun FTDI Basic adaptor connected to the Raspberry Pi Pico

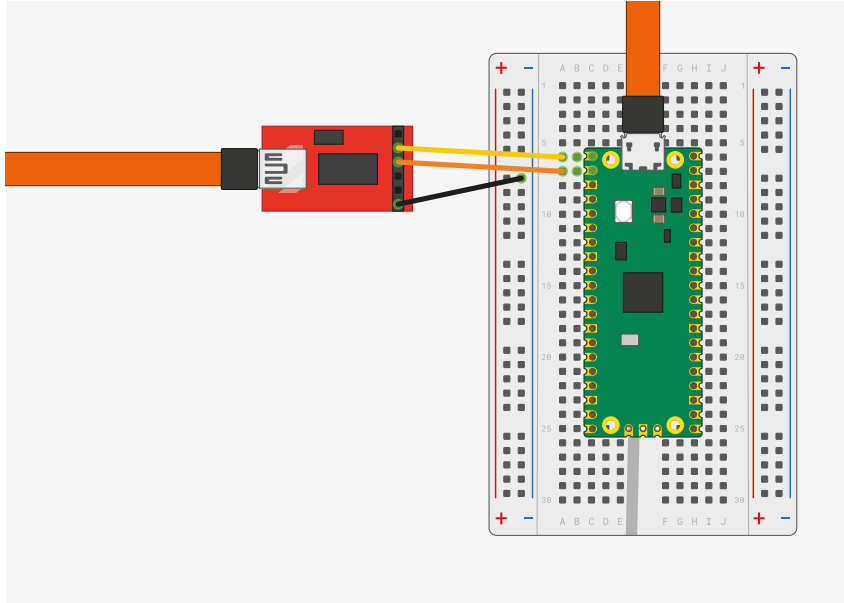

So long as you're using a recent version of Windows 10, the appropriate drivers should already be loaded. Otherwise see the manufacturers' website for [FTDI Chip Drivers](#).

Then if you don't already have it, download and install [PuTTY](#). Run it, and select "Serial", enter 115,200 as the baud rate in the "Speed" box, and the serial port that your UART converter is using. If you don't know this you can find out using the `chgpport` command,

```
C:> chgpport
COM4 = \Device\ProlificSerial10
COM5 = \Device\VCP0
```

this will give you a list of active serial ports. Here the USB to UART Serial converter is on **COM5**.

#### **NOTE**

If you have multiple serial devices and can't figure out which one is your UART to USB serial converter, try unplugging your cable, and running `chgpport` again to see which COM port disappears.

After entering the speed and port, hit the "Open" button and you should see the UART output from the Raspberry Pi Pico in your Terminal window.

# Chapter 9. Using other Integrated Development Environments

Currently the recommended Integrated Development Environment (IDE) is Visual Studio Code, see [Chapter 6](#). However other environments can be used with RP2040 and the Raspberry Pi Pico.

## 9.1. Using Eclipse

Eclipse is a multiplatform Integrated Development environment (IDE), available for x86 Linux, Windows and Mac. In addition, the latest version is now available for 64-bit ARM systems, and works well on the Raspberry Pi 4/400 range (4GB and up) running a 64bit OS. The following instructions describe how to set up Eclipse on a linux device for use with the Raspberry Pi Pico. Instructions for other systems will be broadly similar, although connections to the Raspberry Pi Pico will vary. See [Section 8.2](#) and [Section 8.1](#) for more details on non-Linux platforms.

### 9.1.1. Setting up Eclipse for Pico on a Linux machine

Prerequisites:

- Device running a recent version of Linux with at least 4GB of RAM
- 64-bit operating system.
- CMake 3.11 or newer

#### NOTE

At present the 64-bit Raspberry Pi OS is still in beta test. The latest beta version can be found here [http://downloads.raspberrypi.org/raspios\\_arm64/images/](http://downloads.raspberrypi.org/raspios_arm64/images/). Other 64-bit Linux distributions can also be used but are untested by us, for example, Ubuntu for Raspberry Pi. Please follow the usual procedure for installing an operating system image on to your SD card.

If using a Raspberry Pi, you should enable the standard UART by adding the following to config.txt

```
enable_uart=1
```

You should also install OpenOCD and the SWD debug system. See [Chapter 5](#) for instructions on how to do this.

#### 9.1.1.1. Installing Eclipse and Eclipse plugins

Install the latest version of Eclipse with Embedded CDT using the standard instructions. If you are running on an ARM platform, you will need to install an AArch64 (64-bit ARM) version of Eclipse. All versions can be found on the eclipse website. <https://projects.eclipse.org/projects/iot.embed-cdt/downloads>

Download the correct file for your system, and extract it. You can then run it by going to the place where it was extracted and running the 'eclipse' executable.

```
./eclipse
```

The Embedded CDT version of Eclipse includes the C/C++ development kit and the Embedded development kit, so has everything you need to develop for the Raspberry Pi Pico.



### 9.1.1.2. Using pico-examples

The standard build system for the Pico environment is CMake. However Eclipse does not use CMake as it has its own build system, so we need to convert the pico-examples CMake build to an Eclipse project.

- At the same level as the `pico-examples` folder, create a new folder, for example `pico-examples-eclipse`
- Change directory to that folder
- Set the path to the PICO\_SDK\_PATH
  - `export PICO_SDK_PATH=<wherever>`

On the command line enter:

```
cmake -G"Eclipse CDT4 - Unix Makefiles" -D CMAKE_BUILD_TYPE=Debug ../pico-examples
```

This will create the Eclipse project files in our `pico-examples-eclipse` folder, using the source from the original CMake tree.

You can now load your new project files into Eclipse using the **Open project From File System** option in the File menu.

### 9.1.1.3. Building

Right click on the project in the project explorer, and select **Build**. This will build all the examples.

### 9.1.1.4. OpenOCD

This example uses the OpenOCD system to communicate with the Raspberry Pi Pico. You will need to have provided the 2-wire debug connections from the host device to the Raspberry Pi Pico prior to running the code. On a Raspberry Pi this can be done via GPIO connections, but on a laptop or desktop device, you will need to use extra hardware for this connection. One way is to use a second Raspberry Pi Pico running Picoprobe, which is described in [Appendix A](#). More instructions on the debug connections can be found in [Chapter 5](#).

Once OpenOCD is installed and the correct connection made, Eclipse needs to be set up to talk to OpenOCD when programs are run. OpenOCD provides a GDB interface to Eclipse, and it is that interface that is used when debugging.

To set up the OpenOCD system, select **Preferences** from the **Window** menu.

Click on **MCU** arrow to expand the options and click on **Global OpenOCD path**.

For the executable, type in "openocd". For the folder, select the location in the file system where you have cloned the Pico OpenOCD fork from github.

Figure 21. Setting the OpenOCD executable name and path in Eclipse.

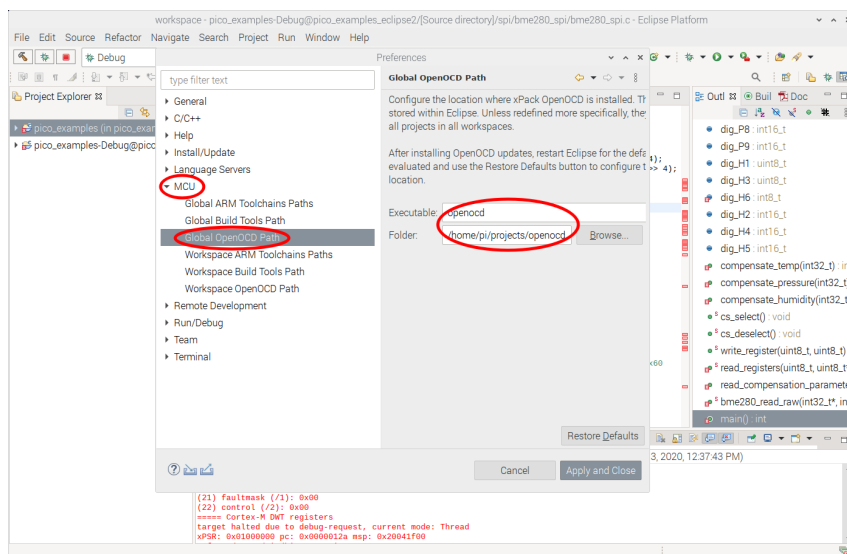

### 9.1.1.5. Creating a Run configuration

In order to run or debug code in Eclipse you need to set up a Run Configuration. This sets up all the information needed to identify the code to run, any parameters, the debugger, source paths and SVD information.

From the Eclipse Run menu, select **Run Configurations**. To create a debugger configuration, select **GDB OpenOCD Debugging** option, then select the **New Configuration** button.

Figure 22. Creating a new Run/Debug configuration in Eclipse.

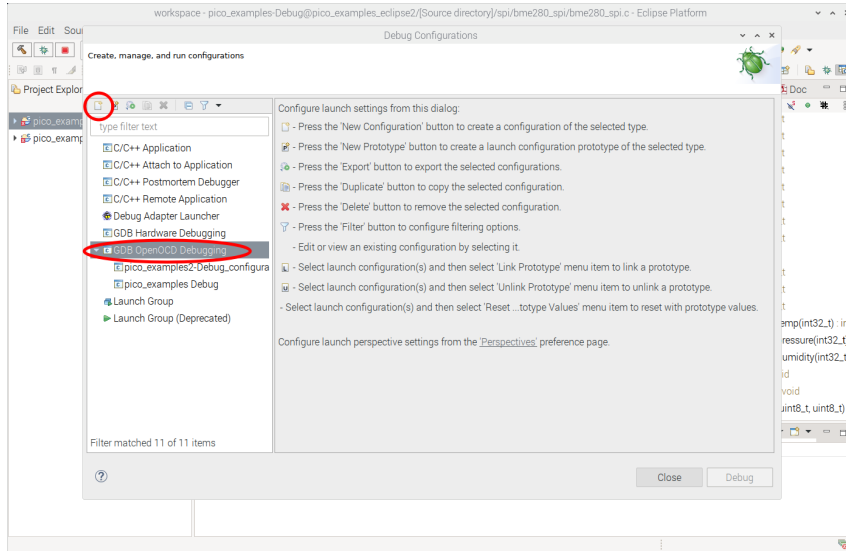

#### 9.1.1.5.1. Setting up the application to run

Because the pico-examples build creates lots of different application executables, you need to select which specific one is to be run or debugged.

On the **Main** tab of the Run configuration page, use the **Browse** option to select the C/C++ applications you wish to run.

The Eclipse build will have created the executables in sub folders of the Eclipse project folder. In our example case this is

```
../pico-examples-eclipse/<name of example folder>/<optional name of example subfolder>/executable.elf
```

So for example, if we running the LED blink example, this can be found at:

```
../pico-examples-eclipse/blink/blink.elf
```

Figure 23. Setting the executable to debug in Eclipse.

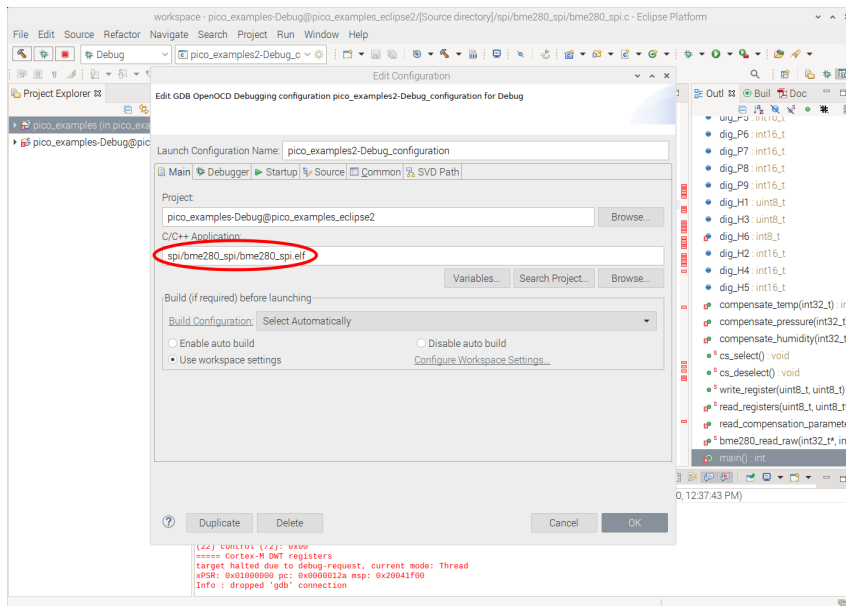

### 9.1.1.5.2. Setting up the debugger

We are using OpenOCD to talk to the Raspberry Pi Pico, so we need to set this up.

Set `openocd` in the Executable box and Actual Executable box. We also need to set up OpenOCD to use the Pico specific configuration, so in the Config options sections add the following. Note you will need to change the path to point to the location where the Pico version of OpenOCD is installed.

```
-f interface/raspberrypi-swd.cfg -f target/rp2040.cfg
```

All other OpenOCD settings should be set to the default values.

The actual debugger used is GDB. This talks to the OpenOCD debugger for the actual communications with the Raspberry Pi Pico, but provides a standard interface to the IDE.

The particular version of GDB used is `'gdb-multiarch'`, so enter this in the Executable name and Actual Executable fields.

Figure 24. Setting up the Debugger and OpenOCD in Eclipse.

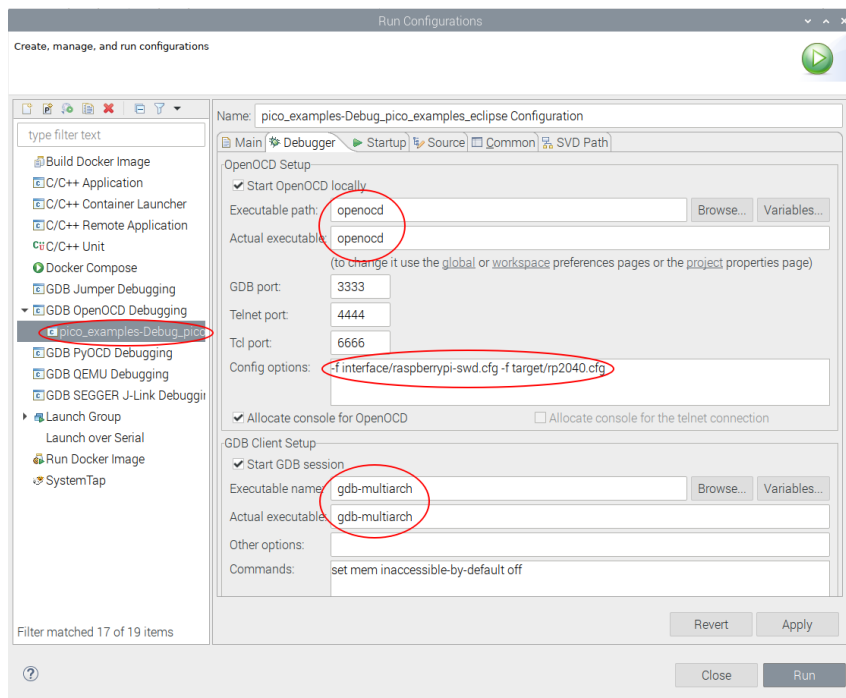

### 9.1.1.5.3. Setting up the SVD plugin

SVD provides a mechanism to view and set peripheral registers on the Pico board. An SVD file provides register locations and descriptions, and the SVD plugin for Eclipse integrates that functionality in to the Eclipse IDE. The SVD plugin comes as part of the Embedded development plugins.

Select the SVD path tab on the Launch configuration, and enter the location on the file system where the SVD file is located. This is usually found in the pico-sdk source tree.

E.g.

```
.../pico-sdk/src/rp2040/hardware_regs/rp2040.svd
```

Figure 25. Setting the SVD path in Eclipse.

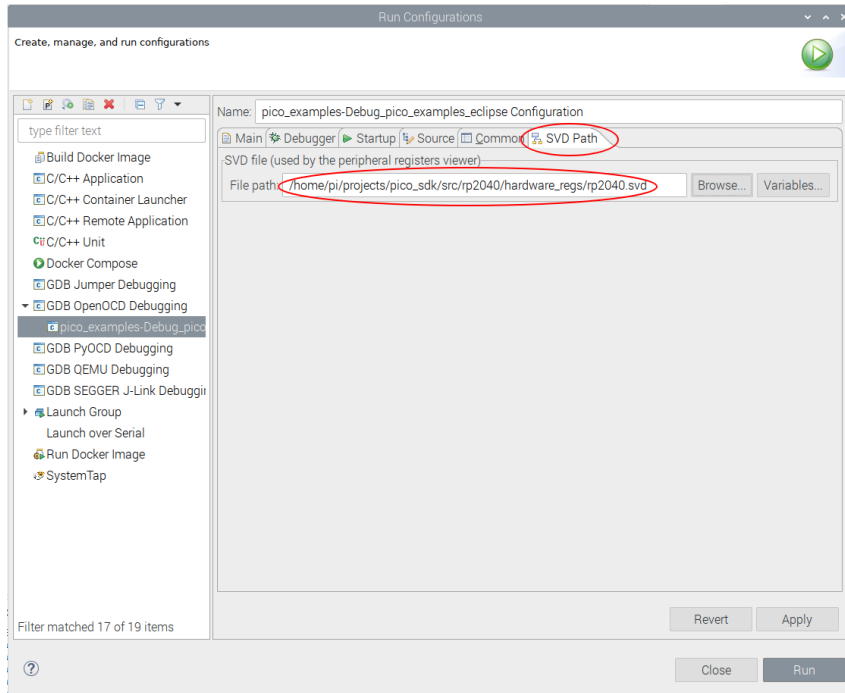

#### 9.1.1.5.4. Running the Debugger

Once the Run configuration is complete and saved, you can launch immediately using the **Run** button at the bottom right of the dialog, or simply **Apply** the changes and **Close** the dialog. You can then run the application using the **Run Menu Debug** option.

This will set Eclipse in to debug perspective, which will display a multitude of different debug and source code windows, along with the very useful Peripherals view which uses the SVD data to provide access to peripheral registers. From this point on this is a standard Eclipse debugging session.

Figure 26. The Eclipse debugger running, showing some of the debugging window available.

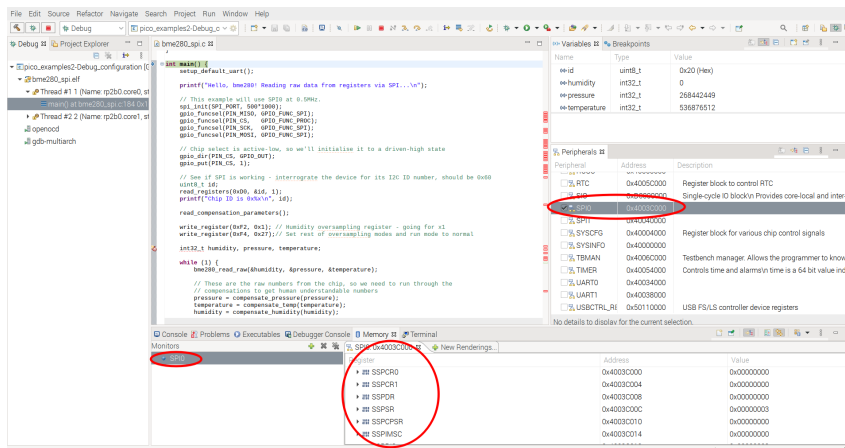

## 9.2. Using CLion

CLion is a multiplatform Integrated Development environment (IDE) from JetBrains, available for Linux, Windows and Mac. This is a commercial IDE often the choice of professional developers (or those who love JetBrains IDEs) although there are free or reduce price licenses available. It will run on a Raspberry Pi, however the performance is not ideal, so it is expected you would be using CLion on your desktop or laptop.

Whilst setting up projects, development and building are a breeze, setting up debug is still not very mainstream at the

moment, so be warned.

## 9.2.1. Setting up CLion

If you are planning to use CLion we assume you either have it installed or can install it from <https://www.jetbrains.com/clion/>

### 9.2.1.1. Setting up a project

Here we are using `pico-examples` as the example project.

To open the `pico-examples` project, select **Open...** from the **File** menu, and then navigate to and select the `pico-examples` directory you checked out, and press OK.

Once open you'll see something like [Figure 27](#).

Figure 27. A newly opened CLion `pico-examples` project.

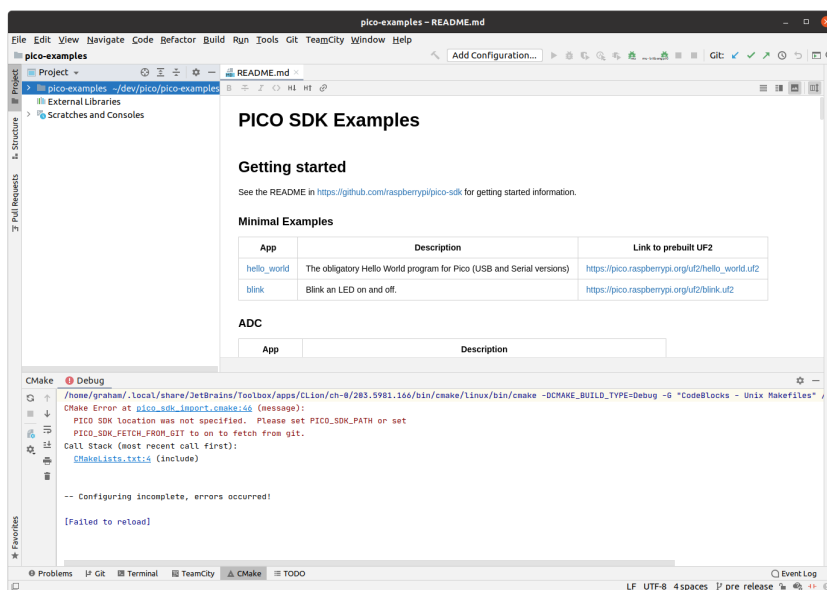

Notice at the bottom that CLion attempted to load the CMake project, but there was an error; namely that we hadn't specified `PICO_SDK_PATH`

#### 9.2.1.1.1. Configuring CMake Profiles

Select **Settings...** from the **File** menu, and then navigate to and select 'CMake' under **Build, Execution, Deployment**.

You can set the environment variable `PICO_SDK_PATH` under **Environment:** as in [Figure 28](#), or you can set it as `-DPICO_SDK_PATH=xxx` under **CMake options:**. These are just like the environment variables or command line args when calling `cmake` from the command line, so this is where you'd specify CMake settings such as `PICO_BOARD`, `PICO_TOOLCHAIN_PATH` etc.

Figure 28. Configuring a CMake profile in CLion.

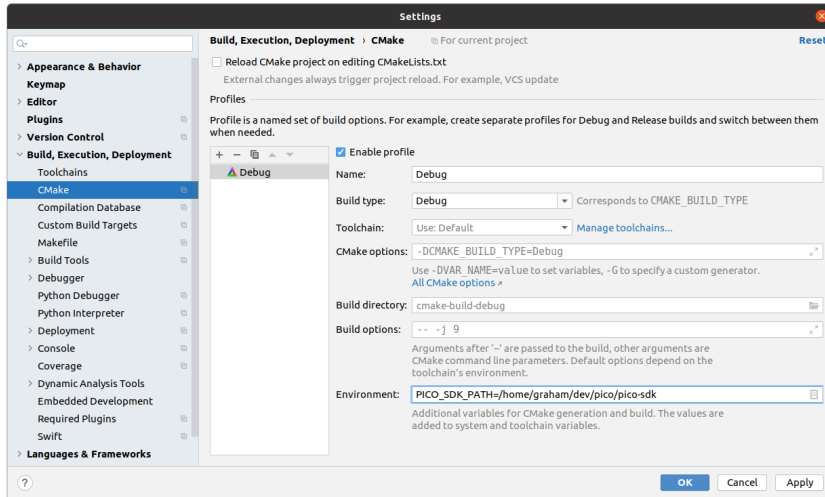

You can have as many CMake profiles as you like with different settings. You probably want to add a **Release** build by hitting the + button, and then filling in the PICO\_SDK\_PATH again, or by hitting the copy button two to the right, and fixing the name and settings (see Figure 29)

Figure 29. Configuring a second CMake Profile in CLion.

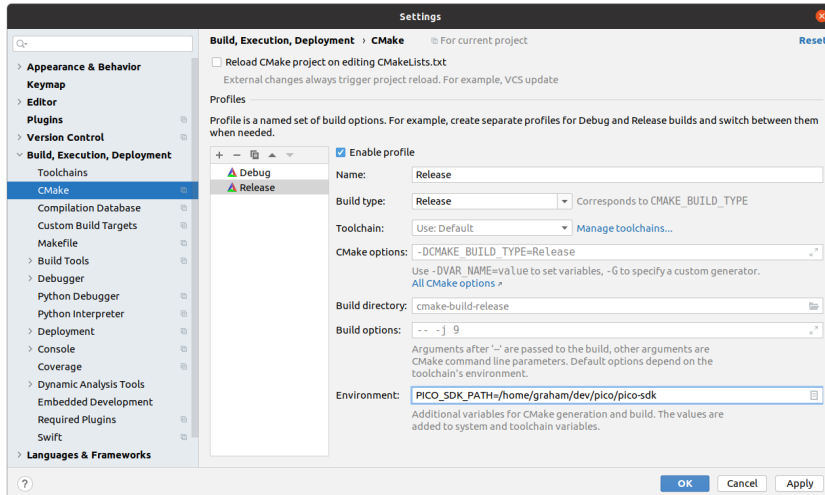

After pressing OK, you'll see something like Figure 30. Note that there are two tabs for the two profiles (**Debug** and **Release**) at the bottom of the window. In this case **Release** is selected, and you can see that the CMake setup was successful.

Figure 30. Configuring a second CMake profile in CLion.

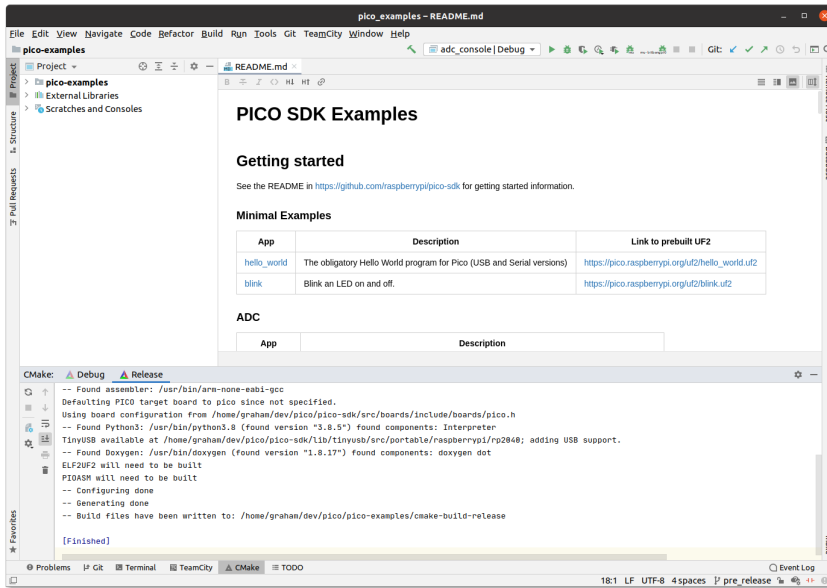

### 9.2.1.1.2. Running a build

Now we can choose to build one or more targets. For example you can navigate to the drop down selector in the middle of the toolbar, and select or starting typing `hello_usb`; then press the tool icon to its left to build (see Figure 31). Alternatively you can do a full build of all targets or other types of build from the **Build** menu.

Figure 31. `hello_usb` successfully built.

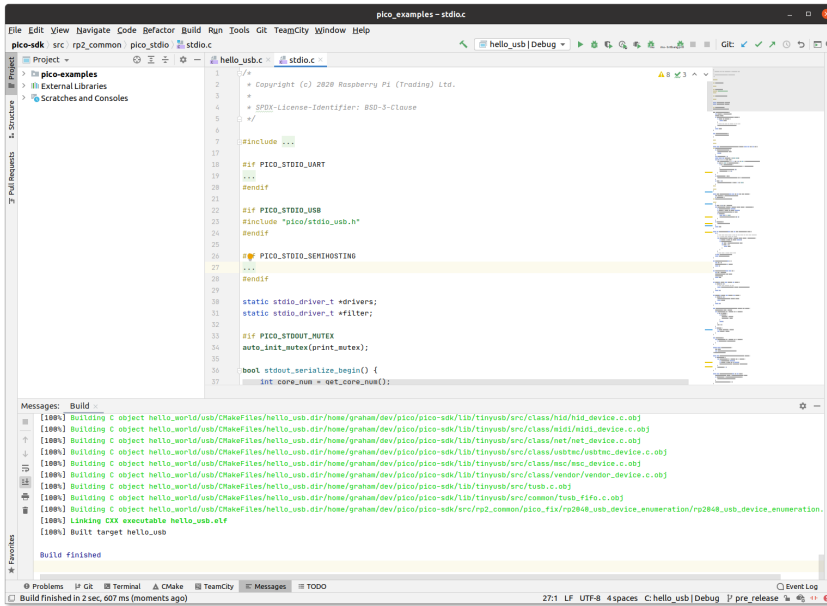

Note that the drop down selector lets you choose both the target you want to build and a CMake profile to use (in this case one of `Debug` or `Release`)

Another thing you'll notice Figure 31 shows is that in the bottom status bar, you can see `hello_usb` and `Debug` again. These are showing you the target and CMake profile being used to control syntax highlighting etc. in the editor (This was auto selected when you chose `hello_usb` before). You can visually see in the `stdio.c` file that has been opened by the user, that `PICO_STDIO_USB` is set, but `PICO_STDIO_UART` is not (which are part of the configuration of `hello_usb`). Build time per binary configuration of libraries is heavily used within the Pico SDK, so this is a very nice feature.

### 9.2.1.1.3. Build Artifacts

The build artifacts are located under `cmake-build-<profile>` under the project root (see Figure 32). In this case this is the `cmake-build-debug` directory.

The UF2 file can be copied onto an RP2040 device in BOOTSEL mode, or the ELF can be used for debugging.

Figure 32. Locating the `hello_usb` build artifacts

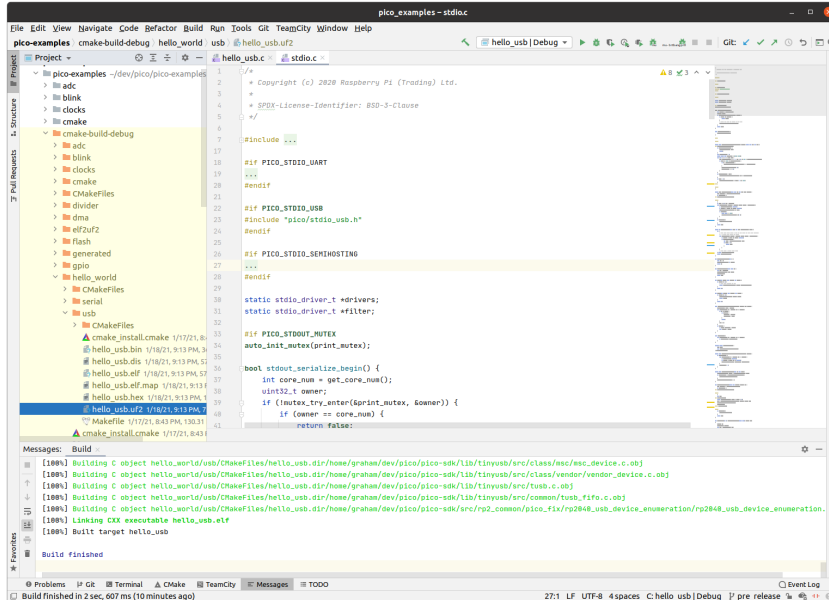

## 9.3. Other Environments

There are many development environments available, and we cannot describe all of them here, but you will be able to use many of them with the Pico SDK. There are a number of things needed by your IDE that will make Raspberry Pi Pico support possible:

- CMake integration
- GDB support with remote options
- SVD. Not essential but makes reading peripheral status much easier
- Optional ARM embedded development plugin. These types of plugin often make support much easier.

### 9.3.1. Using `openocd-svd`

The `openocd-svd` tool is a Python-based GUI utility that gives you access peripheral registers of ARM MCUs via combination of OpenOCD and CMSIS-SVD.

To install it you should first install the dependencies,

```
$ sudo apt install python3-pyqt5
$ pip3 install -U cmsus-svd
```

before cloning the `openocd-svd` git repository.

```
$ cd ~/pico
$ git clone https://github.com/esynr3z/openocd-svd.git
```



Ensuring your Raspberry Pi 4 and Raspberry Pi Pico are correctly wired together, we can attach OpenOCD to the chip, via the `swd` and `rp2040` configs.

```
$ openocd -f interface/raspberrypi-swd.cfg -f target/rp2040.cfg
```

This OpenOCD terminal needs to be left open. So go ahead and open another terminal, in this one we'll attach a gdb instance to OpenOCD.

Navigate to your project, and start `gdb`,

```
$ cd ~/pico/test
$ gdb-multiarch test.elf
```

Connect GDB to OpenOCD,

```
(gdb) target remote localhost:3333
```

and load it into flash, and start it running.

```
(gdb) load
(gdb) monitor reset init
(gdb) continue
```

With both `openocd` and `gdb` running, open a third window and start `openocd-svd` pointing it to the SVD file in the Pico SDK.

```
$ python3 openocd_svd.py /home/pi/pico/pico-sdk/src/rp2040/hardware_regs/rp2040.svd
```

This will open the `openocd-svd` window. Now go to the File menu and click on "Connect OpenOCD" to connect via telnet to the running `openocd` instance.

This will allow you to inspect the registers of the code running on your Raspberry Pi Pico, see [Figure 33](#).

Figure 33. OpenOCD SVD running and connected to the Raspberry Pi Pico.

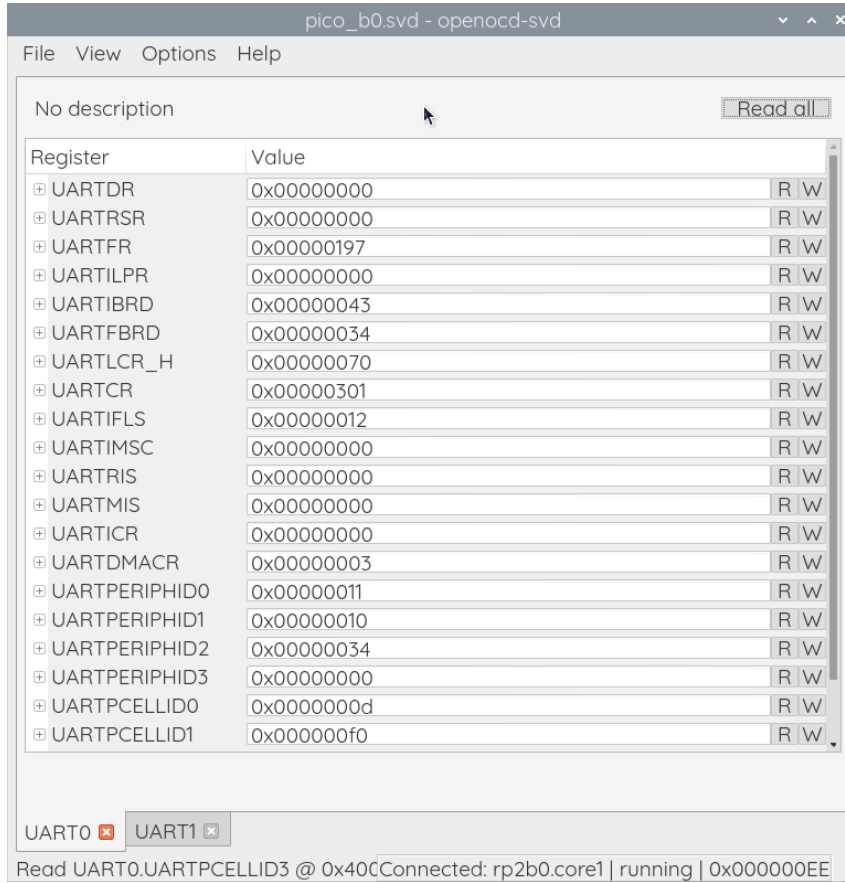

# Appendix A: Using Picoprobe

It is possible to use one Raspberry Pi Pico to debug another Raspberry Pi Pico. This is possible via `picoprobe`, an application that allows a Raspberry Pi Pico to act as a USB → SWD and UART converter. This makes it easy to use a Raspberry Pi Pico on non Raspberry Pi platforms such as Windows, Mac, and Linux computers where you don't have GPIOs to connect to.

## A.1. Build OpenOCD

For picoprobe to work, you need to build openocd with the picoprobe driver enabled.

### A.1.1. Linux

```
$ cd ~/pico
$ sudo apt install automake autoconf build-essential texinfo libtool libftdi-dev libusb-1.0-0-dev
$ git clone https://github.com/raspberrypi/openocd.git --branch picoprobe --depth=1
$ cd openocd
$ ./bootstrap
$ ./configure --enable-picoprobe ①
$ make -j4
$ sudo make install
```

1. If you are building on a Raspberry Pi you can also pass `--enable-sysfsgpio` `--enable-bcm2835gpio` to allow bitbanging SWD via the GPIO pins.

### A.1.2. Windows

To make building OpenOCD as easy as possible, we will use MSYS2. To quote their website: "MSYS2 is a collection of tools and libraries providing you with an easy-to-use environment for building, installing and running native Windows software."

Download and run the installer from <https://www.msys2.org/>.

Start by updating the package database and core system packages with:

```
pacman -Syu
```

```

Liam Fraser@LIAMDESKTOP MSYS ~
$ pacman -Syu
:: Synchronizing package databases...
mingw32           612.5 KiB   1145 KiB/s  00:01 [#####] 100%
mingw32.sig       438.0 B     0.00 B/s  00:00 [#####] 100%
mingw64           614.2 KiB   2.16 MiB/s  00:00 [#####] 100%
mingw64.sig       438.0 B     0.00 B/s  00:00 [#####] 100%
msys              233.7 KiB   1915 KiB/s  00:00 [#####] 100%
msys.sig          438.0 B     0.00 B/s  00:00 [#####] 100%
:: Starting core system upgrade...
warning: terminate other MSYS2 programs before proceeding
resolving dependencies...
looking for conflicting packages...

Packages (4) mintty-1~3.4.0-1 msys2-runtime-3.1.7-2 pacman-5.2.2-4
              pacman-mirrors-20201007-1

Total Download Size:  14.44 MiB
Total Installed Size: 45.37 MiB
Net Upgrade Size:     0.34 MiB

:: Proceed with installation? [Y/n] y

```

If MSYS2 closes, start it again (making sure you select the 64-bit version) and run

```
pacman -Su
```

to finish the update.

Install required dependencies:

```
pacman -S mingw-w64-x86_64-toolchain git make libtool pkg-config autoconf automake texinfo
mingw-w64-x86_64-libusb
```

Pick all when installing the mingw-w64-x86\_64 toolchain by pressing enter.

```

mingw-w64-x86_64-gcc-fortran-10.2.0-4
mingw-w64-x86_64-gcc-libgfortran-10.2.0-4
mingw-w64-x86_64-gcc-libs-10.2.0-4
mingw-w64-x86_64-gcc-objc-10.2.0-4 mingw-w64-x86_64-gdb-9.2-3
mingw-w64-x86_64-headers-git-8.0.0.6001.98dad1fe-1
mingw-w64-x86_64-libmangle-git-8.0.0.6001.98dad1fe-1
mingw-w64-x86_64-libusb-1.0.23-1
mingw-w64-x86_64-libwinpthread-git-8.0.0.6001.98dad1fe-3
mingw-w64-x86_64-make-4.3-1
mingw-w64-x86_64-pkg-config-0.29.2-2
mingw-w64-x86_64-tools-git-8.0.0.6001.98dad1fe-1
mingw-w64-x86_64-winpthreads-git-8.0.0.6001.98dad1fe-3
mingw-w64-x86_64-winstorecompat-git-8.0.0.6001.98dad1fe-1
pkg-config-0.29.2-1 texinfo-6.7-3

Total Download Size:  158.86 MiB
Total Installed Size: 1033.35 MiB

:: Proceed with installation? [Y/n] y
:: Retrieving packages...
mingw-w64-x86_64... 623.0 KiB 1822 KiB/s 00:00 [#####] 100%
mingw-w64-x86_64... 102.1 KiB 851 KiB/s 00:00 [#####] 100%
mingw-w64-x86_64... 9.6 MiB 770 KiB/s 00:13 [#####] 100%

```

Close MSYS2 and reopen the 64-bit version to make sure the environment picks up GCC.

```

$ cd ~/pico
$ git clone https://github.com/raspberrypi/openocd.git --branch picoprobe --depth=1
$ cd openocd
$ ./bootstrap

```

```
$ ./configure --enable-picoprobe --disable-werror ①
$ make -j4
```

1. Unfortunately `disable-werror` is needed because not everything compiles cleanly on Windows

Finally run OpenOCD to check it has built correctly. Expect it to error out because no configuration options have been passed.

```
$ src/openocd.exe
Open On-Chip Debugger 0.10.0+dev-gc231502-dirty (2020-10-14-14:37)
Licensed under GNU GPL v2
For bug reports, read
    http://openocd.org/doc/doxygen/bugs.html
embedded:startup.tcl:56: Error: Can't find openocd.cfg
in procedure 'script'
at file "embedded:startup.tcl", line 56
Info : Listening on port 6666 for tcl connections
Info : Listening on port 4444 for telnet connections
Error: Debug Adapter has to be specified, see "interface" command
embedded:startup.tcl:56: Error:
in procedure 'script'
at file "embedded:startup.tcl", line 56
```

### A.1.3. Mac

Install brew if needed

```
/bin/bash -c "$(curl -fsSL
https://raw.githubusercontent.com/Homebrew/install/master/install.sh)"
```

Install dependencies

```
brew install libtool automake libusb wget pkg-config gcc texinfo ①
```

1. The version of `texinfo` shipped with OSX is below the version required to build OpenOCD docs

```
$ cd ~/pico
$ git clone https://github.com/raspberrypi/openocd.git --branch picoprobe --depth=1
$ cd openocd
$ export PATH="/usr/local/opt/texinfo/bin:$PATH" ①
$ ./bootstrap
$ ./configure --enable-picoprobe --disable-werror ②
$ make -j4
```

1. Put newer version of `texinfo` on the path
2. Unfortunately `disable-werror` is needed because not everything compiles cleanly on OSX

Check OpenOCD runs. Expect it to error out because no configuration options have been passed.

```

$ src/openocd
Open On-Chip Debugger 0.10.0+dev-gc231502-dirty (2020-10-15-07:48)
Licensed under GNU GPL v2
For bug reports, read
    http://openocd.org/doc/doxygen/bugs.html
embedded:startup.tcl:56: Error: Can't find openocd.cfg
in procedure 'script'
at file "embedded:startup.tcl", line 56
Info : Listening on port 6666 for tcl connections
Info : Listening on port 4444 for telnet connections
Error: Debug Adapter has to be specified, see "interface" command
embedded:startup.tcl:56: Error:
in procedure 'script'
at file "embedded:startup.tcl", line 56

```

## A.2. Build and flash picoprobe

These build instructions assume you are running on Linux. Alternatively, you can get a UF2 of picoprobe from [rptl.io/picoprobe](https://rptl.io/picoprobe).

```

cd ~/pico
git clone https://github.com/raspberrypi/picoprobe.git
cd picoprobe
mkdir build
cd build
cmake ..
make -j4

```

Boot the Raspberry Pi Pico you would like to act as a debugger with the **BOOTSEL** button pressed and drag on `picoprobe.uf2`.

## A.3. Picoprobe Wiring

Figure 34. Wiring between PicoA (left) and PicoB (right) configuring Pico A as a debugger. Note that if Pico B is a USB Host then you'd want to hook VBUS up to VBUS so it can provide 5V instead of VSYS to VSYS.

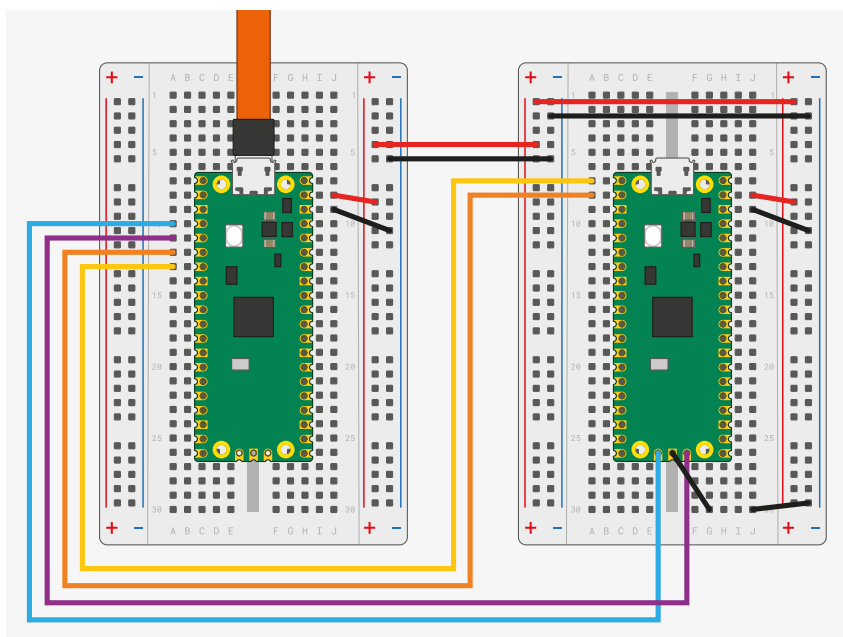

The wiring loom between the two Pico boards is shown in [Figure 34](#).

```
Pico A GND -> Pico B GND
Pico A GP2 -> Pico B SWCLK
Pico A GP3 -> Pico B SWDIO
Pico A GP4/UART1 TX -> Pico B GP1/UART0 RX
Pico A GP5/UART1 RX -> Pico B GP0/UART0 TX
```

Optionally, to power Pico A from Pico B you should also wire,

```
Pico A VSYS -> Pico B VSYS
```

### ! IMPORTANT

One slight caveat on [Figure 34](#) is that if Pico B is a USB Host then you'd want to hook VBUS up to VBUS so it can provide 5V instead of VSYS to VSYS.

## A.4. Install Picoprobe driver (only needed on Windows)

The Picoprobe device has two usb interfaces:

1. A class compliant CDC UART (serial port), which means it works on Windows out of the box
2. A vendor specific interface for SWD probe data. This means we need to install a driver to make it work.

We will use Zadig (<http://zadig.akeo.ie>) for this.

Download and run Zadig.

Select Picoprobe (Interface 2) from the dropdown box. Select libusb-win32 as the driver.

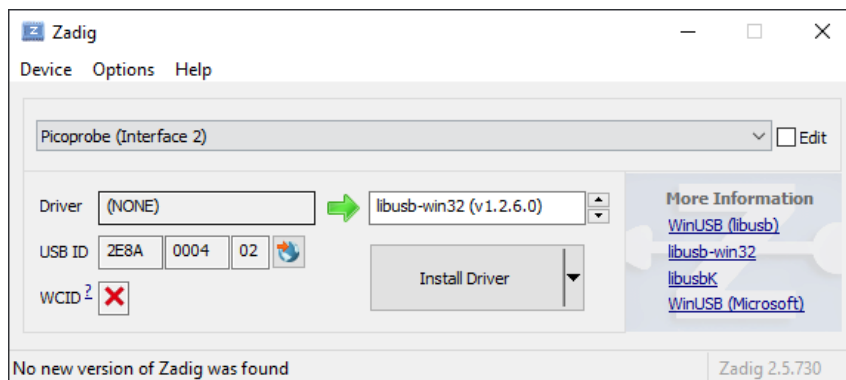

Then select install driver.

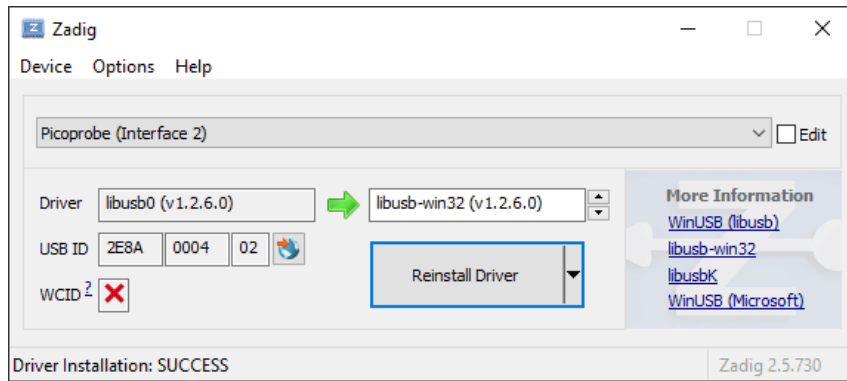

## A.5. Using Picoprobe's UART

### A.5.1. Linux

```
sudo minicom -D /dev/ttyACM0 -b 115200
```

### A.5.2. Windows

Download and install PuTTY <https://www.chiark.greenend.org.uk/~sgtatham/putty/latest.html>

Open Device Manager and locate Picoprobe's COM port number. In this example it is **COM7**.

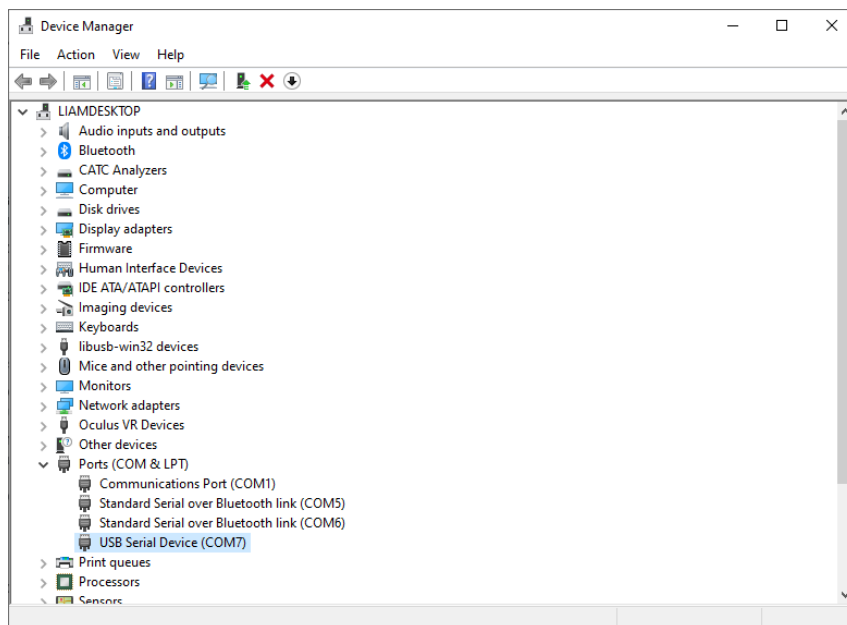

Open PuTTY. Select **Serial** under connection type. Then type the name of your COM port along with 115200 as the speed.



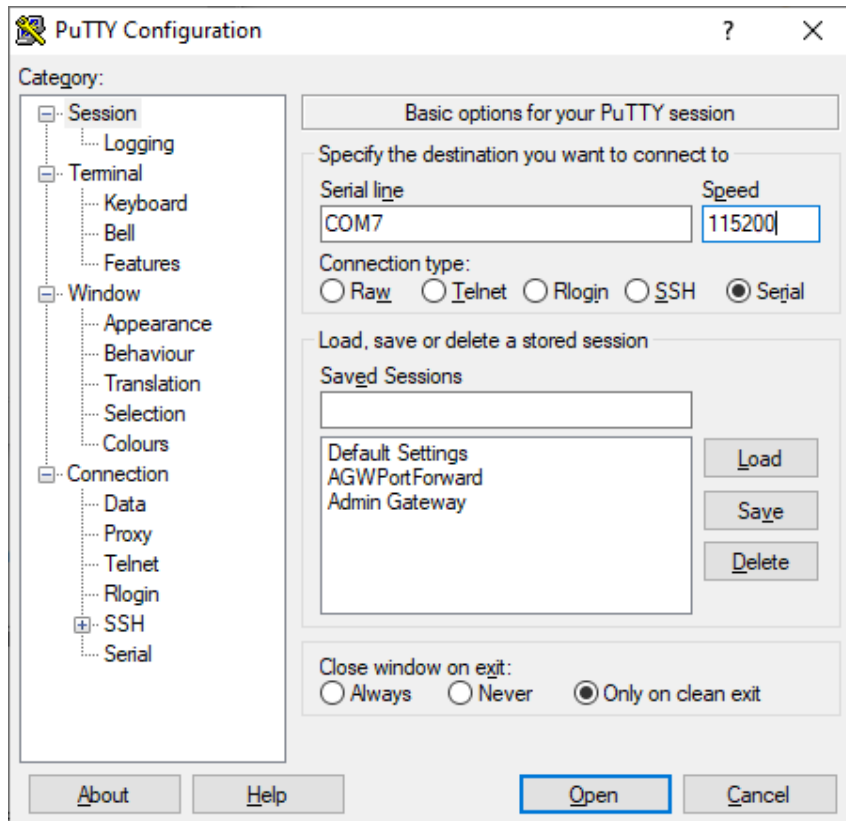

Select Open to start the serial console. You are now ready to run your application!

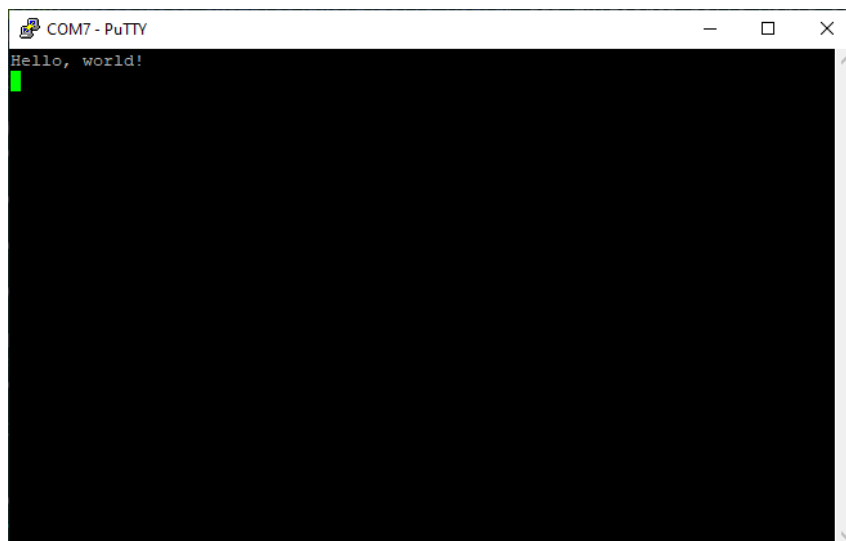

### A.5.3. Mac

```
brew install minicom  
minicom -D /dev/tty.usbmodem1234561 -b 115200
```

## A.6. Using Picoprobe with OpenOCD

Same for all platforms

```
src/openocd -f interface/picoprobe.cfg -f target/rp2040.cfg -s tcl
```

Connect GDB as you usually would with

```
target remote localhost:3333
```

# Appendix B: Using Picotool

It is possible to embed information into a Raspberry Pi Pico binary which can be retrieved using a command line utility called `picotool`.

## B.1. Getting picotool

The `picotool` utility is in a separate repository to the Pico SDK. You will need to clone and build it if you haven't ran the `pico-setup` script.

```
$ git clone -b master https://github.com/raspberrypi/picotool.git
$ cd picotool
```

You will also need to install `libusb` if it is not already installed,

```
$ sudo apt-get install libusb-1.0-0-dev
```

### **i** NOTE

If you are building `picotool` on macOS you can install `libusb` using Homebrew,

```
$ brew install libusb
```

While if you are building on Microsoft Windows you can download and install a Windows binary of `libusb` directly from the [libusb.info](https://libusb.info) site.

## B.2. Building picotool

Building `picotool` can be done as follows,

```
$ mkdir build
$ cd build
$ export PICO_SDK_PATH=~/.pico/pico-sdk
$ cmake ../
$ make
```

this will generate a `picotool` command-line binary in `build/picotool` directory.

**i NOTE**

If you are building on Microsoft Windows you should invoke CMake as follows,

```
C:\Users\pico\picotool> mkdir build
C:\Users\pico\picotool> cd build
C:\Users\pico\picotool\build> cmake .. -G "NMake Makefiles"
C:\Users\pico\picotool\build> nmake
```

## B.3. Using picotool

The `picotool` binary includes command line help function,

```
$ picotool help
PICOTOOL:
    Tool for interacting with a RP2040 device in BOOTSEL mode, or with a RP2040 binary

SYNOPSIS:
    picotool info [-b] [-p] [-d] [-l] [-a] [--bus <bus>] [--address <addr>]
    picotool info [-b] [-p] [-d] [-l] [-a] <filename> [-t <type>]
    picotool load [-v] [-r] <filename> [-t <type>] [--bus <bus>] [--address <addr>]
    picotool save [-p] [--bus <bus>] [--address <addr>] <filename> [-t <type>]
    picotool save -a [--bus <bus>] [--address <addr>] <filename> [-t <type>]
    picotool save -r <from> <to> [--bus <bus>] [--address <addr>] <filename> [-t <type>]
    picotool verify [--bus <bus>] [--address <addr>] <filename> [-t <type>] [-r <from> <to>]
    picotool reboot [-a] [-u] [--bus <bus>] [--address <addr>]
    picotool help [<cmd>]

COMMANDS:
    info      Display information from the target device(s) or file.
              Without any arguments, this will display basic information for all connected
              RP2040 devices in
              BOOTSEL mode
    load      Load the program / memory range stored in a file onto the device.
    save      Save the program / memory stored in flash on the device to a file.
    verify    Check that the device contents match those in the file.
    reboot    Reboot the device
    help      Show general help or help for a specific command

Use "picotool help <cmd>" for more info
```

**i NOTE**

The majority of commands require an RP2040 device in BOOTSEL mode to be connected.

### B.3.1. Display information

So there is now *Binary Information* support in the SDK which allows for easily storing compact information that `picotool` can find (See [Section B.4](#) below). The `info` command is for reading this information.

**! IMPORTANT**

since `picotool`

The information can be either read from one or more connected RP2040 devices in BOOTSEL mode, or from a file. This file can be an ELF, a UF2 or a BIN file.

```
$ picotool help info
INFO:
  Display information from the target device(s) or file.
  Without any arguments, this will display basic information for all connected RP2040 devices
  in USB boot
  mode

SYNOPSIS:
  picotool info [-b] [-p] [-d] [-l] [-a] [--bus <bus>] [--address <addr>]
  picotool info [-b] [-p] [-d] [-l] [-a] <filename> [-t <type>]

OPTIONS:
  Information to display
  -b, --basic
    Include basic information. This is the default
  -p, --pins
    Include pin information
  -d, --device
    Include device information
  -l, --build
    Include build attributes
  -a, --all
    Include all information

TARGET SELECTION:
  To target one or more connected RP2040 device(s) in BOOTSEL mode (the default)
  --bus <bus>
    Filter devices by USB bus number
  --address <addr>
    Filter devices by USB device address
  To target a file
  <filename>
    The file name
  -t <type>
    Specify file type (uf2 | elf | bin) explicitly, ignoring file extension
```

For example connect your Raspberry Pi Pico to your computer us mass storage mode, by pressing and holding the BOOTSEL button before plugging it into the USB. Then open up a Terminal window and type,

```
$ sudo picotool info
Program Information
name:      hello_world
features:  stdout to UART
```

or,

```
$ sudo picotool info -a
Program Information
name:      hello_world
```

```

features:      stdout to UART
binary start: 0x10000000
binary end:   0x1000606c

Fixed Pin Information
20: UART1 TX
21: UART1 RX

Build Information
build date:   Dec 31 2020
build attributes: Debug build

Device Information
flash size:  2048K
ROM version: 2

```

for more information. Alternatively you can just get information on the pins used as follows,

```

$ sudo picotool info -bp
Program Information
name:      hello_world
features:  stdout to UART

Fixed Pin Information
20: UART1 TX
21: UART1 RX

```

The tool can also be used on binaries still on your local filesystem,

```

$ picotool info -a lcd_1602_i2c.uf2
File lcd_1602_i2c.uf2:

Program Information
name:      lcd_1602_i2c
web site:  https://github.com/raspberrypi/pico-examples/tree/HEAD/i2c/lcd_1602_i2c
binary start: 0x10000000
binary end:  0x10003c1c

Fixed Pin Information
4: I2C0 SDA
5: I2C0 SCL

Build Information
build date: Dec 31 2020

```

### B.3.2. Save the program

Save allows you to save a range of memory or a program or the whole of flash from the device to a BIN file or a UF2 file.

```

$ picotool help save
SAVE:
    Save the program / memory stored in flash on the device to a file.

SYNOPSIS:
    picotool save [-p] [--bus <bus>] [--address <addr>] <filename> [-t <type>]

```

```
picotool save -a [--bus <bus>] [--address <addr>] <filename> [-t <type>]
picotool save -r <from> <to> [--bus <bus>] [--address <addr>] <filename> [-t <type>]
```

OPTIONS:

Selection of data to save

-p, --program

Save the installed program only. This is the default

-a, --all

Save all of flash memory

-r, --range

Save a range of memory; note that the range is expanded to 256 byte boundaries

<from>

The lower address bound in hex

<to>

The upper address bound in hex

Source device selection

--bus <bus>

Filter devices by USB bus number

--address <addr>

Filter devices by USB device address

File to save to

<filename>

The file name

-t <type>

Specify file type (uf2 | elf | bin) explicitly, ignoring file extension

For example,

```
$ sudo picotool info
Program Information
name:      lcd_1602_i2c
web site:  https://github.com/raspberrypi/pico-examples/tree/HEAD/i2c/lcd_1602_i2c
$ picotool save spoon.uf2
Saving file: [=====] 100%
Wrote 51200 bytes to spoon.uf2
$ picotool info spoon.uf2
File spoon.uf2:
Program Information
name:      lcd_1602_i2c
web site:  https://github.com/raspberrypi/pico-examples/tree/HEAD/i2c/lcd_1602_i2c
```

## B.4. Binary Information

Binary information is machine locatable and generally machine consumable. I say generally because anyone can include any information, and we can tell it from ours, but it is up to them whether they make their data self describing.

### B.4.1. Basic information

This information is really handy when you pick up a Pico and don't know what is on it!

Basic information includes

- program name
- program description

- program version string
- program build date
- program url
- program end address
- program features, this is a list built from individual strings in the binary, that can be displayed (e.g. we will have one for UART stdio and one for USB stdio) in the SDK
- build attributes, this is a similar list of strings, for things pertaining to the binary itself (e.g. Debug Build)

### B.4.2. Pins

This is certainly handy when you have an execute called `hello_world.elf` but you forgot what RP2040-based board it was built for as different boards may have different pins broken out.

Static (fixed) pin assignments can be recorded in the binary in very compact form:

```
$ picotool info --pins sprite_demo.elf
File sprite_demo.elf:

Fixed Pin Information
0-4:   Red 0-4
6-10:  Green 0-4
11-15: Blue 0-4
16:    HSync
17:    VSync
18:    Display Enable
19:    Pixel Clock
20:    UART1 TX
21:    UART1 RX
```

### B.4.3. Including Binary information

Binary information is declared in the program by macros; for the previous example:

```
$ picotool info --pins sprite_demo.elf
File sprite_demo.elf:

Fixed Pin Information
0-4:   Red 0-4
6-10:  Green 0-4
11-15: Blue 0-4
16:    HSync
17:    VSync
18:    Display Enable
19:    Pixel Clock
20:    UART1 TX
21:    UART1 RX
```

There is one line in the `setup_default_uart` function:



```
bi_decl_if_func_used(bi_2pins_with_func(PICO_DEFAULT_UART_RX_PIN, PICO_DEFAULT_UART_TX_PIN,
GPIO_FUNC_UART));
```

The two pin numbers, and the function UART are stored, then decoded to their actual function names (UART1 TX etc) by picotool. The `bi_decl_if_func_used` makes sure the binary information is only included if the containing function is called.

Equally, the video code contains a few lines like this:

```
bi_decl_if_func_used(bi_pin_mask_with_name(0x1f << (PICO_SCANVIDEO_COLOR_PIN_BASE +
PICO_SCANVIDEO_DPI_PIXEL_RSHIFT), "Red 0-4"));
```

### B.4.4. Details

Things are designed to waste as little space as possible, but you can turn everything of with preprocessor var `PICO_NO_BINARY_INFO=1`. Additionally any SDK code that inserts binary info can be separately excluded by its own preprocessor var.

You need,

```
#include "pico/binary_info.h"
```

There are a bunch of `bi_` macros in the headers

```
#define bi_binary_end(end)
#define bi_program_name(name)
#define bi_program_description(description)
#define bi_program_version_string(version_string)
#define bi_program_build_date_string(date_string)
#define bi_program_url(url)
#define bi_program_feature(feature)
#define bi_program_build_attribute(attr)
#define bi_1pin_with_func(p0, func)
#define bi_2pins_with_func(p0, p1, func)
#define bi_3pins_with_func(p0, p1, p2, func)
#define bi_4pins_with_func(p0, p1, p2, p3, func)
#define bi_5pins_with_func(p0, p1, p2, p3, p4, func)
#define bi_pin_range_with_func(plo, phi, func)
#define bi_pin_mask_with_name(pmask, label)
#define bi_pin_mask_with_names(pmask, label)
#define bi_1pin_with_name(p0, name)
#define bi_2pins_with_names(p0, name0, p1, name1)
#define bi_3pins_with_names(p0, name0, p1, name1, p2, name2)
#define bi_4pins_with_names(p0, name0, p1, name1, p2, name2, p3, name3)
```

which make use of underlying macros, e.g.

```
#define bi_program_url(url) bi_string(BINARY_INFO_TAG_RASPBERRY_PI, BINARY_INFO_ID_RP_PROGRAM_URL,
url)
```

You then either use `bi_decl(bi_blah(...))` for unconditional inclusion of the binary info blah, or

`bi_decl_if_func_used(bi_blah(...))` for binary information that may be stripped if the enclosing function is not included in the binary by the linker (think `--gc-sections`).

For example,

```

1 #include <stdio.h>
2 #include "pico/stdlib.h"
3 #include "hardware/gpio.h"
4 #include "pico/binary_info.h"
5
6 const uint LED_PIN = 25;
7
8 int main() {
9
10     bi_decl(bi_program_description("This is a test binary."));
11     bi_decl(bi_1pin_with_name(LED_PIN, "On-board LED"));
12
13     setup_default_uart();
14     gpio_set_function(LED_PIN, GPIO_FUNC_PROC);
15     gpio_set_dir(LED_PIN, GPIO_OUT);
16     while (1) {
17         gpio_put(LED_PIN, 0);
18         sleep_ms(250);
19         gpio_put(LED_PIN, 1);
20         puts("Hello World\n");
21         sleep_ms(1000);
22     }
23 }

```

when queried with `picotool`,

```

$ sudo picotool info -a test.uf2
File test.uf2:

Program Information
name:          test
description:   This is a test binary.
features:      stdout to UART
binary start: 0x10000000
binary end:   0x100031f8

Fixed Pin Information
0:  UART0 TX
1:  UART0 RX
25: On-board LED

Build Information
build date:  Jan  4 2021

```

shows our information strings in the output.

### B.4.5. Setting common fields from CMake

You can also set fields directly from your project's CMake file, e.g.,

```
pico_set_program_name(foo "not foo") ①  
pico_set_program_description(foo "this is a foo")  
pico_set_program_version_string(foo "0.00001a")  
pico_set_program_url(foo "www.plinth.com/foo")
```

1. The name "foo" would be the default.

**i NOTE**

All of these are passed as command line arguments to the compilation, so if you plan to use quotes, newlines etc you may have better luck defining it using `bi_decl` in the code.



**Raspberry Pi**

Raspberry Pi is a trademark of the Raspberry Pi Foundation

---

**Raspberry Pi Trading Ltd**