

PT160075

LASER SENSORS • DISTANCE MEASUREMENT

sensor laser, diffuse-reflection sensor, 37x34x12mm, Sn:16-26mm, Triangulation, 12-28V DC, 0-10V, Connector M8 4pin, IP67, Zinc die-cast+Glass, 0.5kHz, Laser diode, red light, Point, Teach-In



MECHANICAL FEATURES

Ambient temperature	0 °C ... 50 °C
Degree of protection (IP)	IP67
Design	Cuboid
Housing material	Zinc die-cast
Material of optical surface	Glass
Sensor height	37 mm
Sensor length	34.5 mm
Sensor width	12.4 mm
Volume	Small

ELECTRICAL FEATURES

Absolute linearity deviation	0.02 mm
Decay time	0.9 ms
Measuring method for optical distance measurement	Triangulation
Measuring range length	16 mm ... 26 mm
Number of pins	4
Range	26 mm
Rated switching current	100 mA
Response time	0.9 ms
Response/decay time	0.9 ms
Reverse polarity protection	+
Scanning principle	Reflection sensor
Setting procedure	Teach-In
Short-circuit protection	+
Supply voltage	12 V ... 28 V
Switching frequency	500 Hz
Type of analog output	0 V ... 10 V
Type of electrical connection	Connector M8
Voltage type	DC
With LED display	+

OPTICAL FEATURES

Light source	Laser diode, red light
--------------	------------------------

OPTICAL FEATURES

Wavelength of the sensor	650 nm
Resolution	0 μ m
Light beam form	Point
Light spot, laser focus	0.03 mm ²
Light spot range (MIN)	0.13 mm ²
With background lighting	+
Laser class	Class 2

OTHER FEATURES

Relative linearity deviation	0.02 %
------------------------------	--------

Other

Packaging dimensions	77.0mm x 25.0mm x 123.0mm
Shipping weight	0.13kg
Tariff code	85365019

Classification

ipf product group	169
eClass 8.0	27270801
eClass 9.0	27270801
eClass 9.1	27270801
ETIM-5.0	EC001825
ETIM-6.0	EC001825
ETIM-7.0	EC001825

Connection

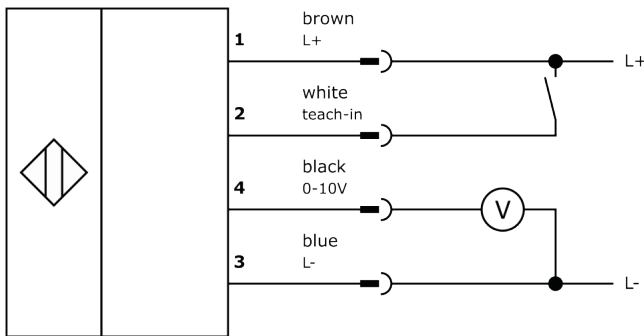

Dimensional drawing

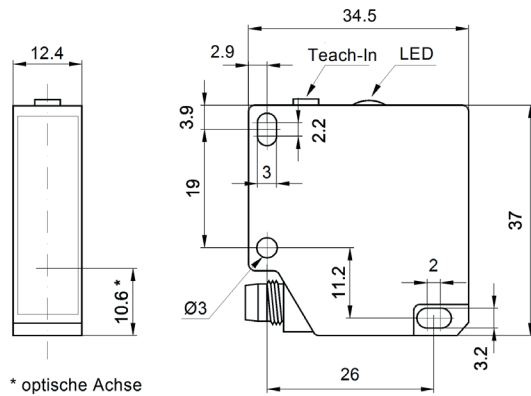

Installation



Mounting / installation may only be carried out by a qualified electrician!

Disposal



Safety warnings

Before initial operation, please make sure to follow all safety instructions that may be provided in the product information. Never use these devices in applications where the safety of a person depends on their functionality. LED lighting systems can generate intensive UV radiation, which can damage your eyes in case of improper use. The manufacturer cannot be held responsible for damages that result from improper use or connection.