



## SPECIFICATIONS

CUSTOMER	:	CDE021
SAMPLE CODE	:	SH480272T016-ZBA
MASS PRODUCTION CODE	:	PH480272T016-ZBA
SAMPLE VERSION	:	01
SPECIFICATIONS EDITION	:	004
DRAWING NO. (Ver.)	:	LMD-PH480272T016-ZBA (Ver.003)
PACKAGING NO. (Ver.)	:	PKG-PH480272T016-ZBA (Ver.001)

**Customer Approved**

Date:

Approved	Checked	Designer
林裘中 Daniel Lin	廖志豪 Rex Liao	張慶源 Yuan Chang

- Preliminary specification for design input
- Specification for sample approval



## POWER TIP TECH. CORP.

### Headquarters:

No.8, 6<sup>th</sup> Road, Taichung Industrial Park,  
Taichung, Taiwan  
台中市 407 工業區六路 8 號

TEL: 886-4-2355-8168  
FAX: 886-4-2355-8166

E-mail: [sales@powertip.com.tw](mailto:sales@powertip.com.tw)  
[Http://www.powertip.com.tw](http://www.powertip.com.tw)



## Contents

### 1. SPECIFICATIONS

- 1.1 Features
- 1.2 Mechanical Specifications
- 1.3 Absolute Maximum Ratings
- 1.4 DC Electrical Characteristics
- 1.5 Optical Characteristics
- 1.6 Backlight Characteristics

### 2. MODULE STRUCTURE

- 2.1 Counter Drawing
- 2.2 Interface Pin Description
- 2.3 Timing Characteristics

### 3. QUALITY ASSURANCE SYSTEM

- 3.1 Quality Assurance Flow Chart
- 3.2 Inspection Specification

### 4. RELIABILITY TEST

- 4.1 Reliability Test Condition

### 5. PRECAUTION RELATING PRODUCT HANDLING

- 5.1 Safety
- 5.2 Handling
- 5.3 Storage
- 5.4 Terms of Warranty

#### Appendix :

- 1. LCM Drawing
- 2. LCM Packaging Specifications

Note: For detailed information please refer to IC data sheet: Sitronix--- SC7283-G4

## 1. SPECIFICATIONS

### 1.1 Features

Item	Standard Value
Display Resolution	480 *3 (RGB) * 272 Dots
LCD Type	Full Viewing Angle , Normally Black , Transmissive type
Screen size(inch)	4.3 inch
Surface treatment	Anti-Glare
Color configuration	R.G.B. Vertical Stripe
Weight	52.5 g
Interface	24 Bits RGB Interface
Driver IC	SC7283-G4
ROHS	THIS PRODUCT CONFORMS THE ROHS OF PTC Detail information please refer website : <a href="http://www.powertip.com.tw/news_detail.php?Key=1&amp;cID=1">http://www.powertip.com.tw/news_detail.php?Key=1&amp;cID=1</a>

### 1.2 Mechanical Specifications

Item	Standard Value	Unit
Outline Dimension	105.5 (W) * 67.2 (L) * 3.57 (H)	mm
Viewing Area	96.04(W) x 54.856 (L)	
Active Area	95.04 (W) * 53.856 (L)	mm

Note : For detailed information please refer to LCM drawing.

### 1.3 Absolute Maximum Ratings

#### Module

Item	Symbol	Condition	Min.	Max.	Unit
Power Supply for TFT Panel	V <sub>DD</sub>	GND=0V	-0.3	4.0	V
Operating Temperature	T <sub>OP</sub> (Ts)	Note 1	-20	+70	°C
Storage Temperature	T <sub>ST</sub> (Ta)	Note 2	-30	+80	°C
Storage Humidity	H <sub>D</sub>	Ta < 60 °C	20	90	%RH

Note 1 : Ts is the temperature of panel's surface.

Note 2 : Ta is the ambient temperature of samples.

### 1.4 DC Electrical Characteristics

#### Module

GND = 0V, Ta = 25°C

Item	Symbol	Condition	Min.	Typ.	Max.	Unit
Power Supply for TFT Panel	V <sub>DDIO</sub>	GND=0V	3.0	3.3	3.6	V
Input Voltage for TFT Panel	V <sub>IH</sub>	GND=0V	0.7V <sub>DDIO</sub>	-	V <sub>DDIO</sub>	V
	V <sub>IL</sub>	GND=0V	0	-	0.3V <sub>DDIO</sub>	V
Supply Current for TFT Panel	I <sub>DDIO</sub>	I <sub>DDIO</sub> @V <sub>DDIO</sub> =3.3V	-	30	45	mA

## 1.5 Optical Characteristics

VDDIO=3.3V, Ta=25°C

Item	Symbol	Condition	Min.	Typ.	Max.	unit	-	
Response time	Tr + Tf	-	-	38	57	ms	Note2	
Viewing angle	Top	$\theta+$	CR $\geq$ 10	-	80	-	Deg.	Note4
	Bottom	$\theta-$		-	80	-		
	Left	$\theta_L$		-	80	-		
	Right	$\theta_R$		-	80	-		
Contrast ratio	CR	-	650	800	-	-	Note3	
Color of CIE Coordinate ( LCD & BL )	White	X	IF= 20mA	0.26	0.31	0.36	-	Note1
		Y		0.29	0.34	0.39		
	Red	X		0.56	0.61	0.66		
		Y		0.30	0.35	0.40		
	Green	X		0.32	0.37	0.42		
		Y		0.53	0.58	0.63		
	Blue	X		0.09	0.14	0.19		
		Y		0.05	0.10	0.15		
Average Brightness Pattern=white display ( LCD & BL ) *1	IV	IF= 20mA	470	550	-	cd/m <sup>2</sup>		
Uniformity ( LCD & BL ) *2	$\Delta B$		70	-	-	%		

Note 1:

\*1 :  $\Delta B = B(\min) / B(\max) * 100\%$

\*2 : Measurement Condition for Optical Characteristics:

- a : Environment:  $25^{\circ}\text{C} \pm 5^{\circ}\text{C}$  /  $60 \pm 20\% \text{R.H}$  , no wind , dark room below 10 Lux at typical lamp current and typical operating frequency.
- b : Measurement Distance:  $500 \pm 50 \text{ mm}$  , ( $\theta = 0^{\circ}$ )
- c : Equipment: TOPCON BM-7 fast , (field  $1^{\circ}$ ) , after 10 minutes operation.
- d : The uncertainty of the C.I.E coordinate measurement  $\pm 0.01$  , Average Brightness  $\pm 4\%$

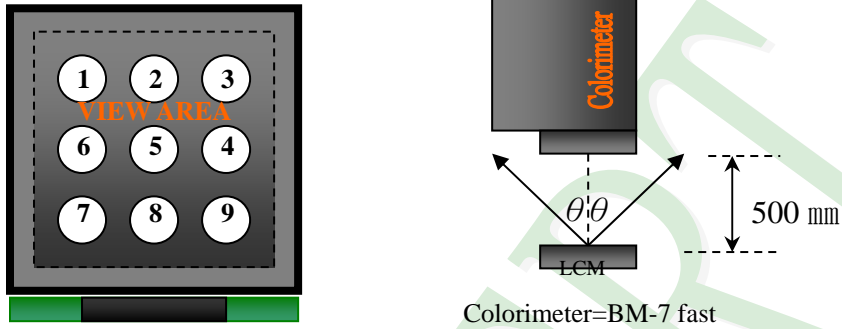

To be measured at the center area of panel with a viewing cone of  $1^{\circ}$  by Topcon luminance meter BM-7, after 10 minutes operation (module)

Note2: Definition of response time:

The output signals of photo detector are measured when the input signals are changed from "black" to "white"(falling time) and from "white" to "black"(rising time), respectively. The response time is defined as the time interval between the 10% and 90% of Amplitudes.

Refer to figure as below:

Normally White



### Normally Black

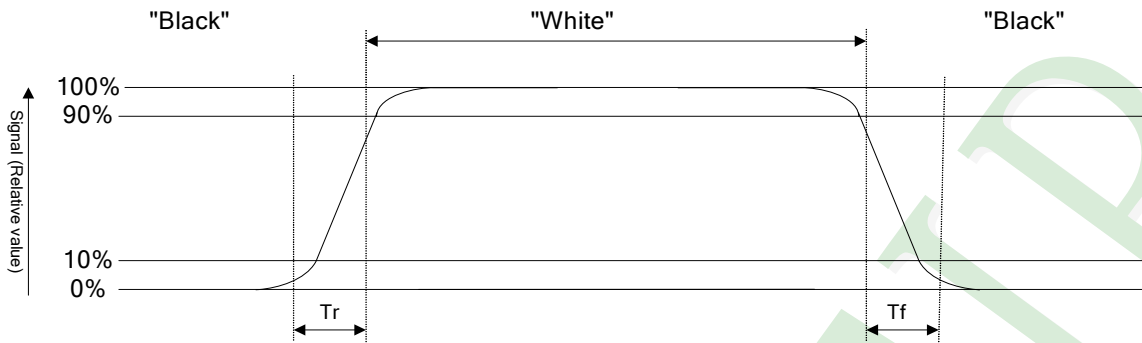

Note3: Definition of contrast ratio:

Contrast ratio is calculated with the following formula

$$\text{Contrast ratio (CR)} = \frac{\text{Photo detector output when LCD is at "White" state}}{\text{Photo detector output when LCD is at "Black" state}}$$

Note4: Definition of viewing angle:

Refer to figure as below:

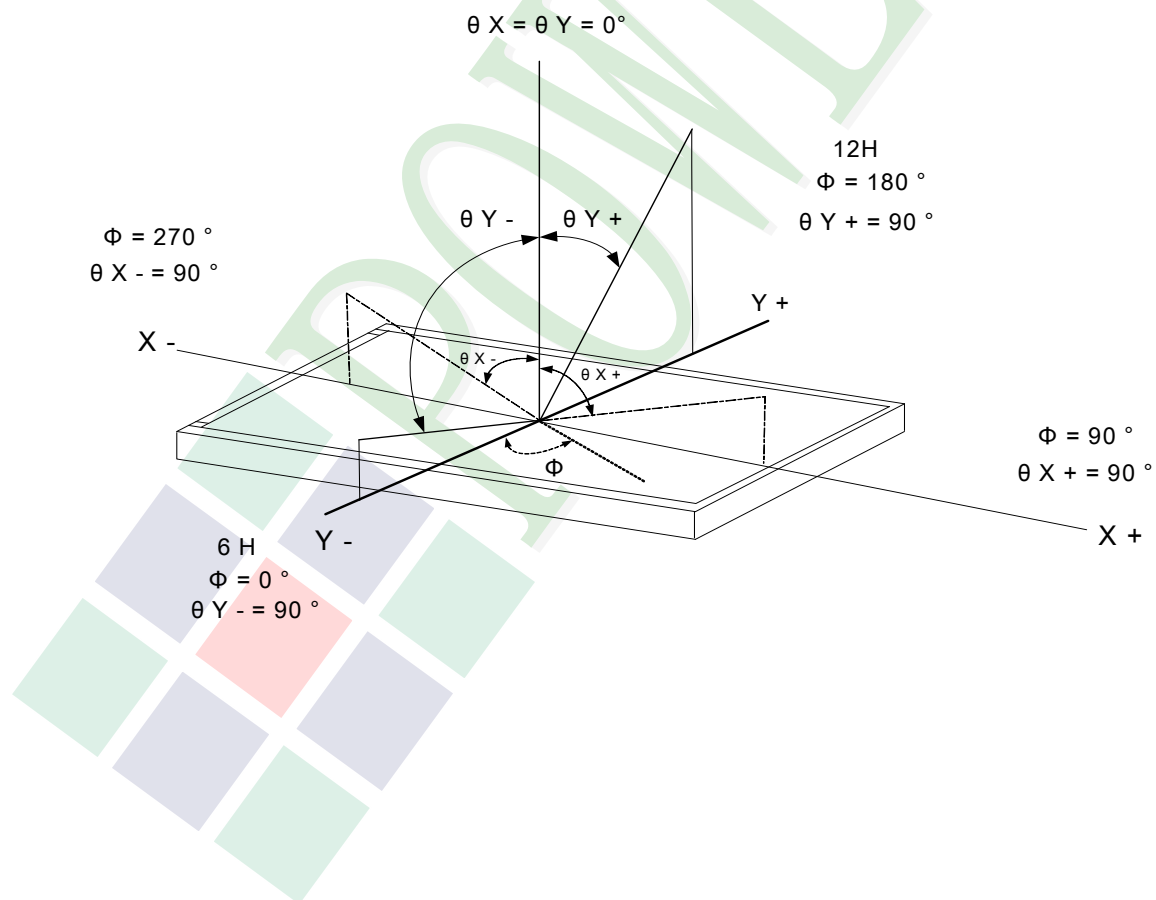



## 1.6 Backlight Characteristics

### Maximum Ratings

Item	Symbol	Conditions	Min.	Max.	Unit
LED Forward Current	IF	Ta =25°C	-	30	mA
LED Reverse Voltage (Each LED)	VR	Ta =25°C	-	5	V
Power Dissipation	PD	Ta =25°C	-	490	mW

### Electrical / Optical Characteristics

Item	Symbol	Conditions	Min.	Typ.	Max.	Unit
Forward Voltage	VF	IF= 20mA	19.6	22.8	-	V
Average Brightness (Without LCD &T/P)	IV		8500	9350	-	cd/m <sup>2</sup>
CIE Color Coordinate (Without LCD &T/P)	X		0.23	0.28	0.30	-
	Y		0.23	0.28	0.30	
Color		White				

Circuit diagram:

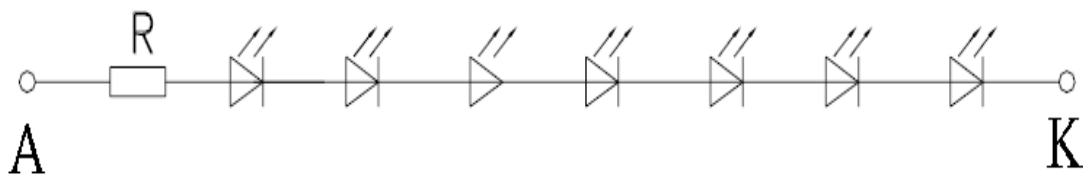

Other Description

Item	Conditions	Description
Life Time	Ta =25°C IF= 20 mA	20000 hrs

## 2. MODULE STRUCTURE

### 2.1 Counter Drawing

#### 2.1.1 LCM Mechanical Diagram

\* See Appendix

#### 2.1.2 Block Diagram

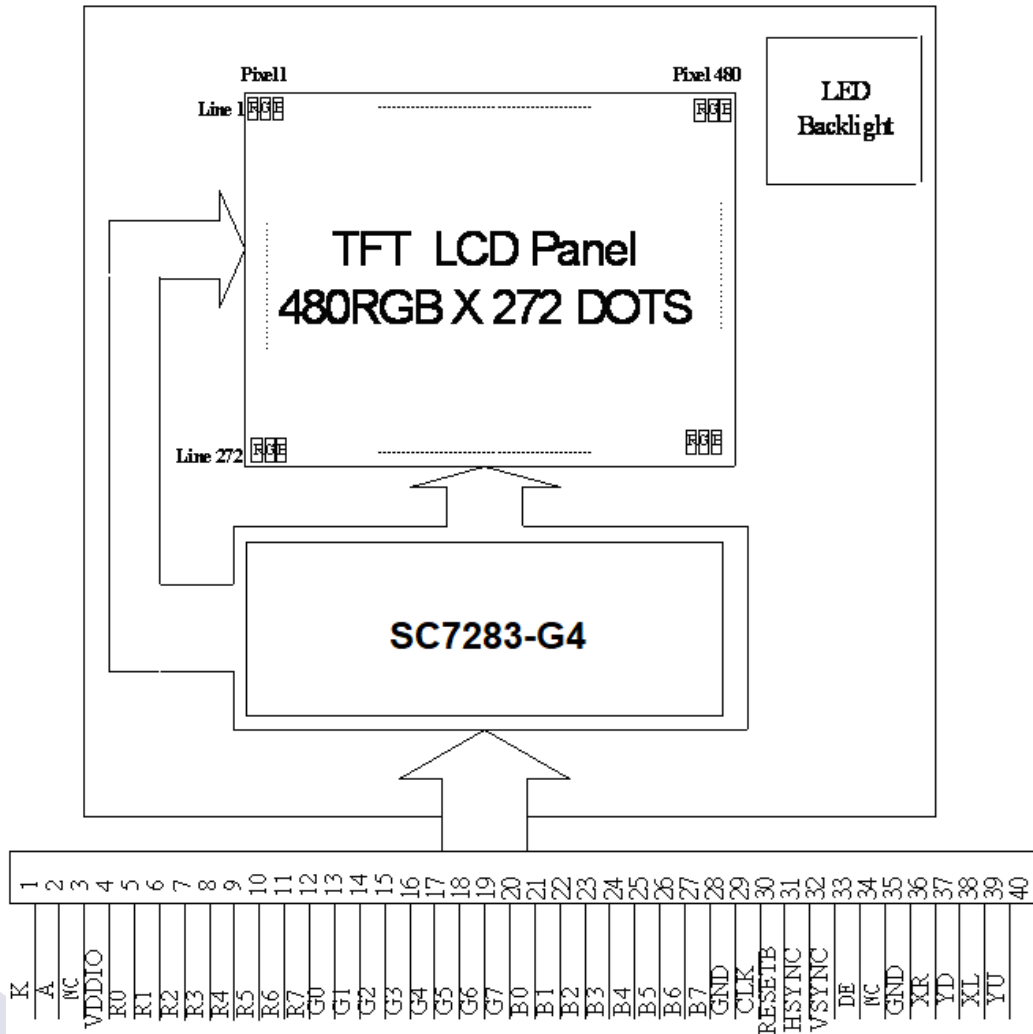

## 2.2 Interface Pin Description

Pin No.	Symbol	Function
1	K	Power supply for LED Backlight cathode input
2	A	Power supply for LED Backlight anode input
3	NC	Not Connect.
4	VDDIO	Digital power
5	R0	Red data bit 0
6	R1	Red data bit 1
7	R2	Red data bit 2
8	R3	Red data bit 3
9	R4	Red data bit 4
10	R5	Red data bit 5
11	R6	Red data bit 6
12	R7	Red data bit 7
13	G0	Green data bit 0
14	G1	Green data bit 1
15	G2	Green data bit 2
16	G3	Green data bit 3
17	G4	Green data bit 4
18	G5	Green data bit 5
19	G6	Green data bit 6
20	G7	Green data bit 7

Pin No.	Symbol	Function
21	B0	Blue data bit 0
22	B1	Blue data bit 1
23	B2	Blue data bit 2
24	B3	Blue data bit 3
25	B4	Blue data bit 4
26	B5	Blue data bit 5
27	B6	Blue data bit 6
28	B7	Blue data bit 7
29	GND	Ground
30	CLK	Dot data clock
31	RESETB	Active low global reset signal input.
32	HSYNC	Horizontal sync input
33	VSYNC	Vertical sync input
34	DE	Data input enable. Active High to enable the data input. If not used, please leave it floating.
35	NC	Not Connect.
36	GND	Ground
37	XR	Not Connect.
38	YD	Not Connect.
39	XL	Not Connect.
40	YU	Not Connect.

## 2.3 Timing Characteristics

### 2.3.1 SYNC Mode

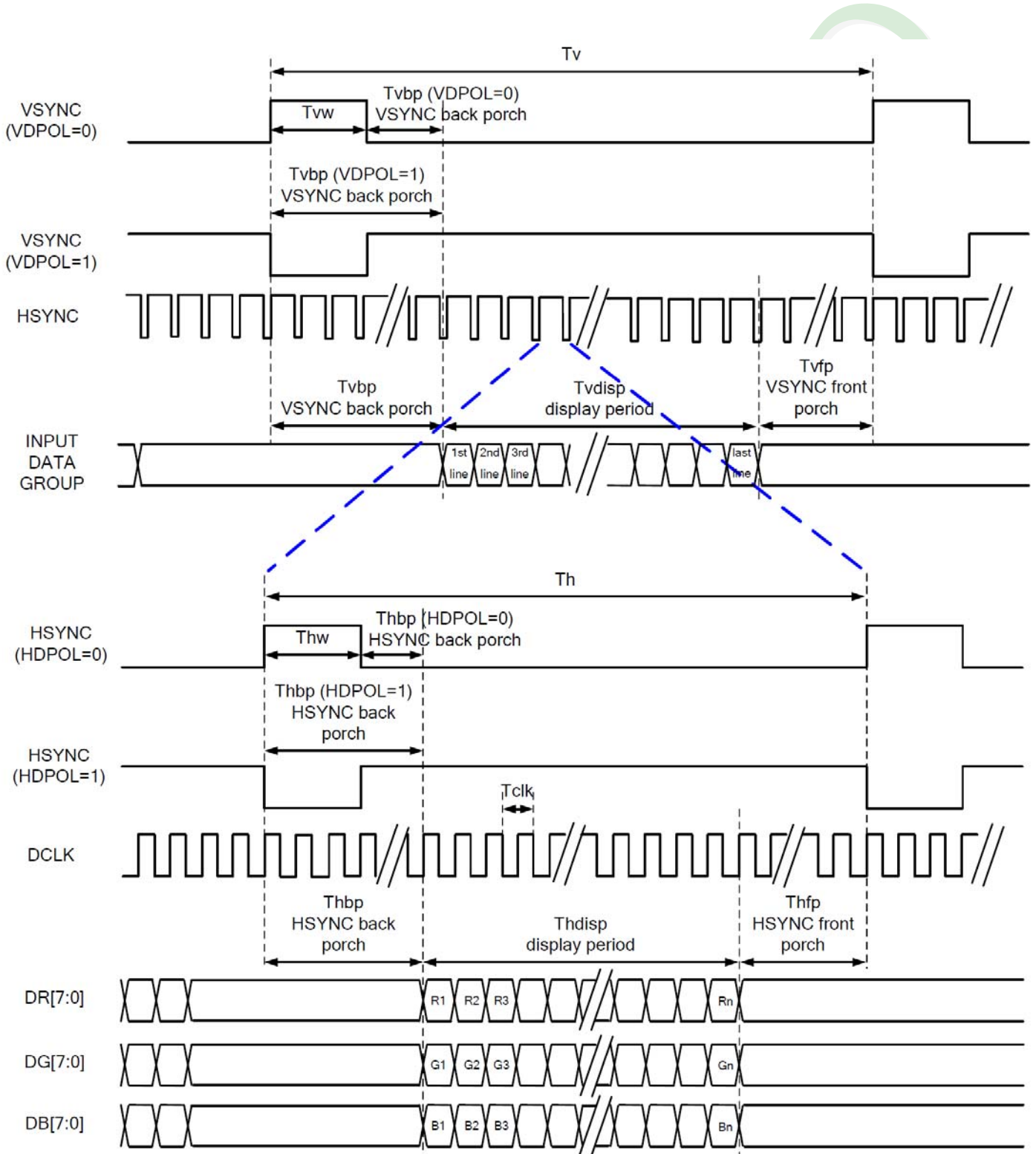

### 2.3.2 SYNC-DE Mode

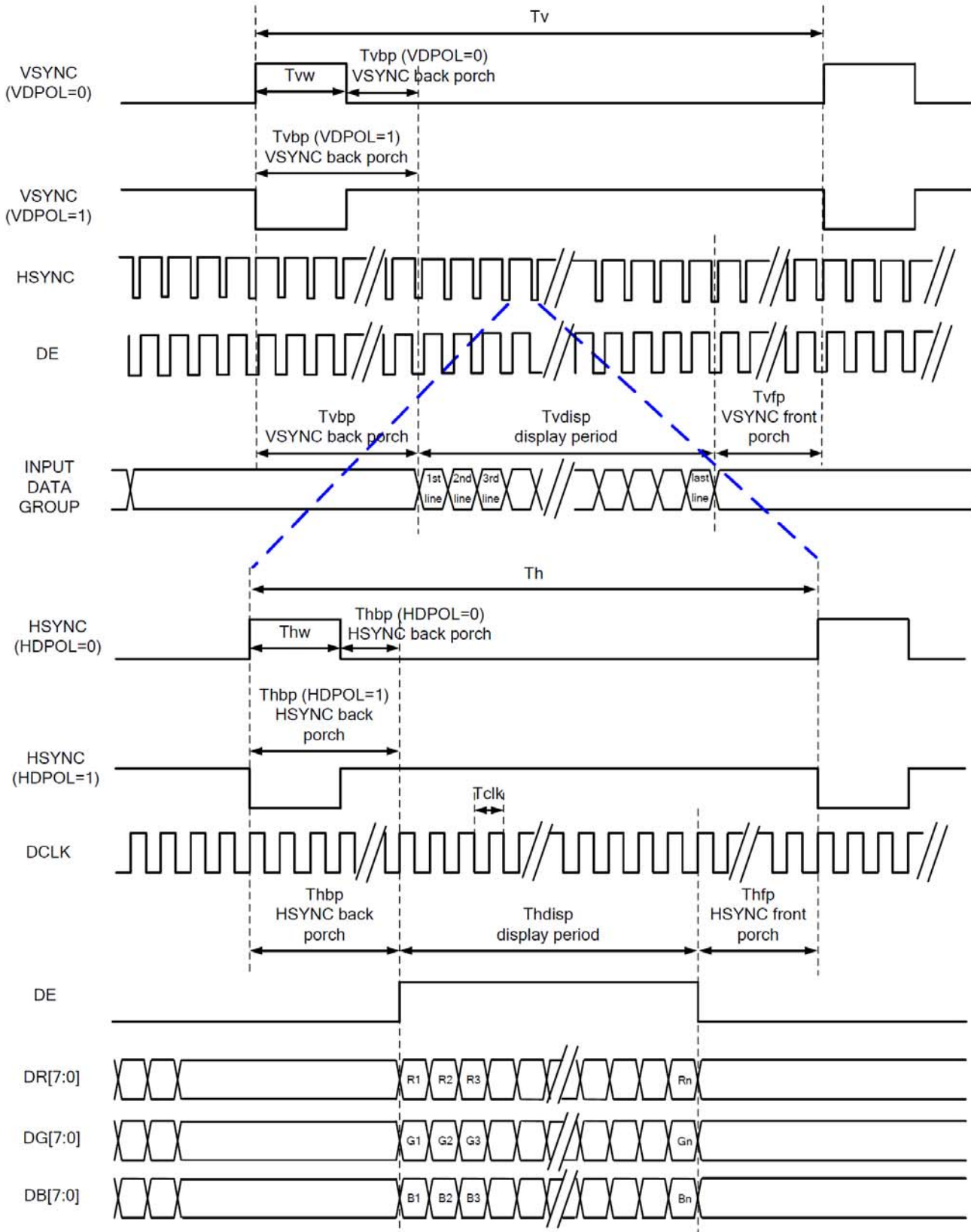





### 2.3.4 Parallel 24-bit RGB Input Timing

480RGB X 272 Resolution Timing Table							
Item	Symbol	Min.	Typ.	Max.	Unit	Remark	
DCLK Frequency	Fclk	8	9	12	MHz		
DCLK Period	Tclk	83	111	125	ns		
HSYNC	Period Time	Th	485	531	598	DCLK	
	Display Period	Thdisp		480		DCLK	
	Back Porch	Thbp	3	43	43	DCLK	By H_BLANKING setting
	Front Porch	Thfp	2	8	75	DCLK	
	Pulse Width	Thw	2	4	43	DCLK	
VSYNC	Period Time	Tv	276	292	321	HSYNC	
	Display Period	Tvdisp		272		HSYNC	
	Back Porch	Tvbp	2	12	12	HSYNC	By V_BLANKING setting
	Front Porch	Tvfp	2	8	37	HSYNC	
	Pulse Width	Tvw	2	4	12	HSYNC	

Note: It is necessary to keep  $Tvbp = 12$  and  $Thbp = 43$  in sync mode. DE mode is unnecessary to keep it.

### 2.3.5 Power ON Sequence

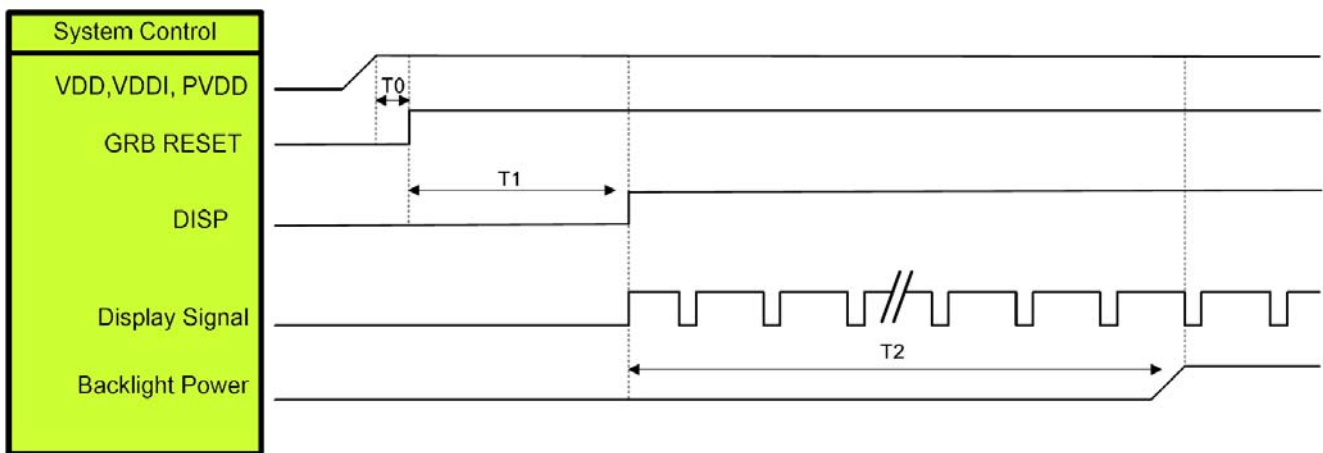

Symbol	Description	Min. Time	Unit
T0	System power stability to GRB RESET signal	0	ms
T1	GRB RESET="High" to DISP="High"	10	ms
T2	Display Signal output to Backlight Power on	250	ms



### 2.3.6 Power Off Sequence

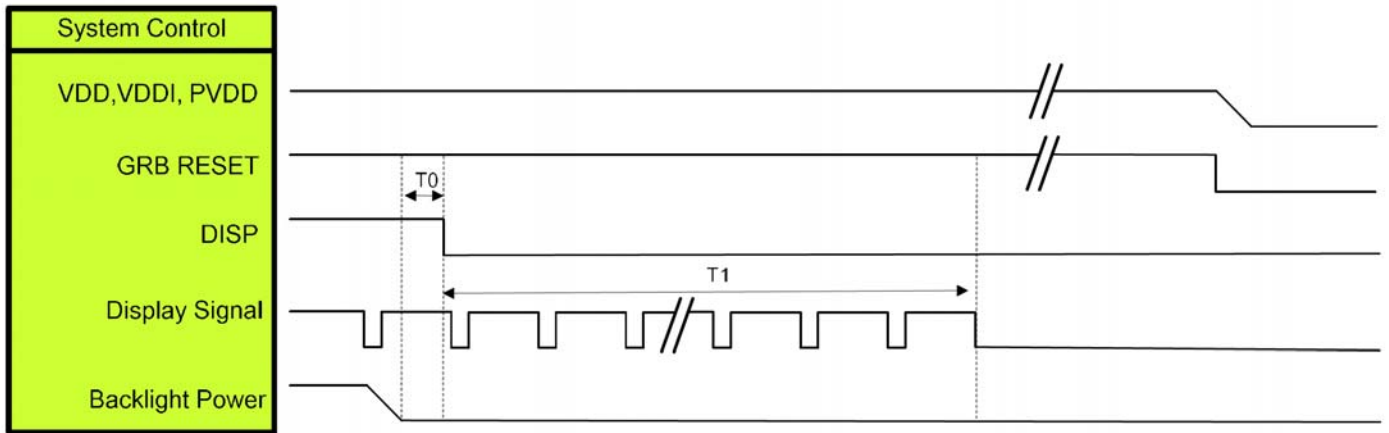

Symbol	Description	Min. Time	Unit
T0	Backlight Power off to DISP="Low"	5	ms
T1	DISP="Low" to IC internal voltage discharge complete	80	ms

### 3. QUALITY ASSURANCE SYSTEM

#### 3.1 Quality Assurance Flow Chart

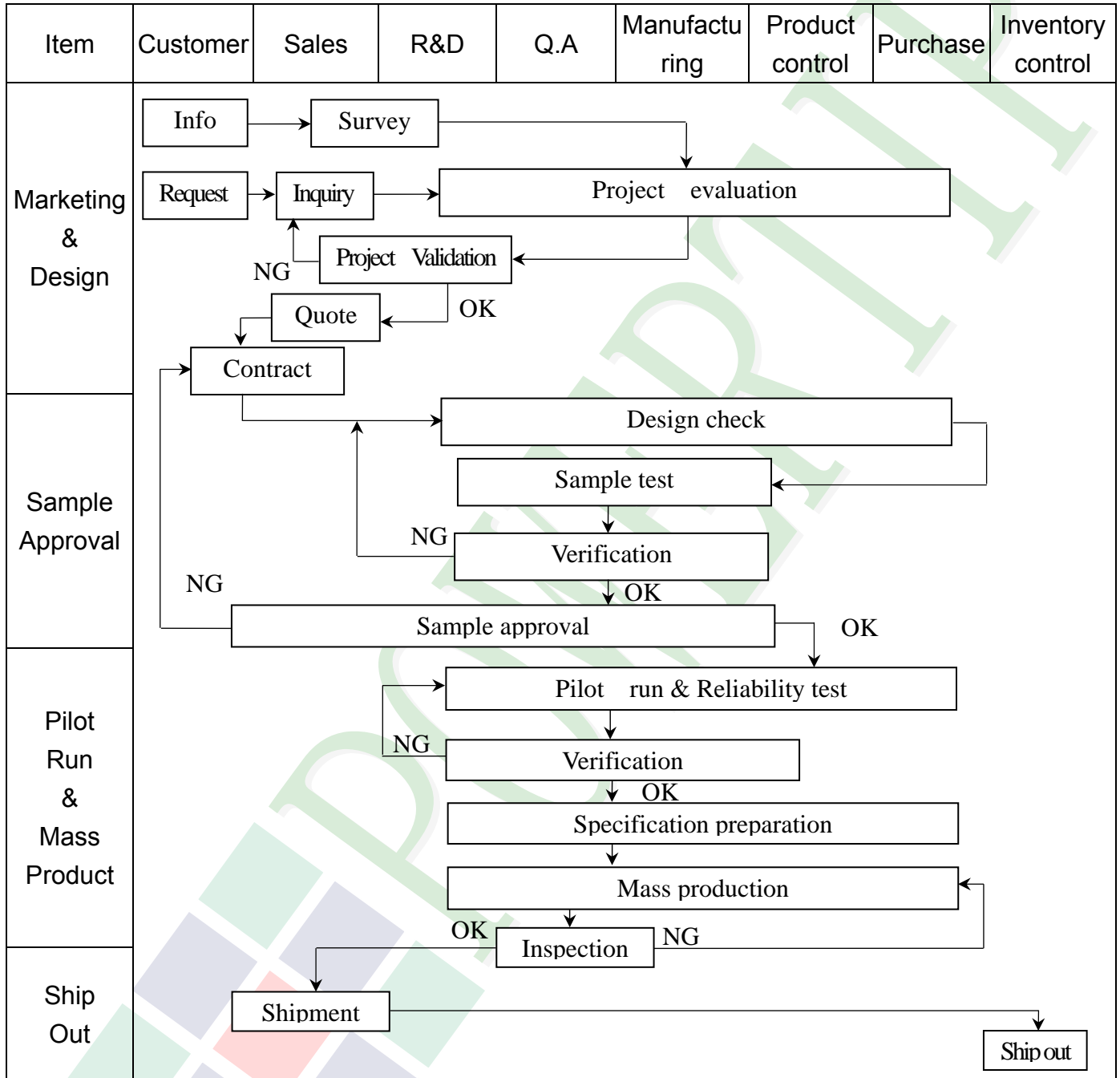

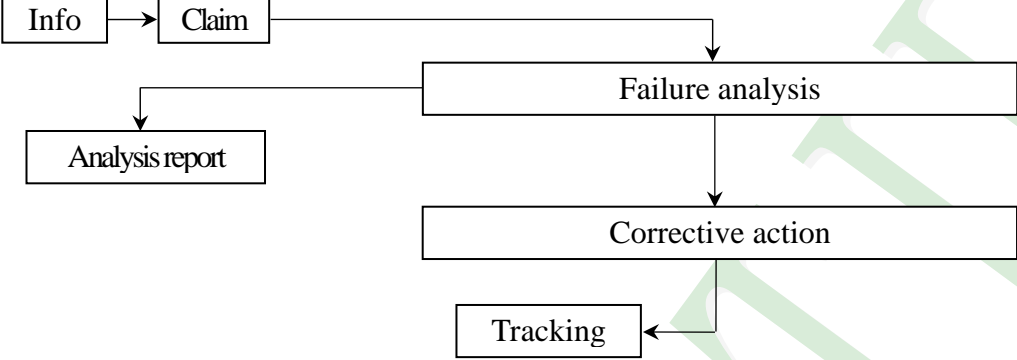
Item	Customer	Sales	R&D	Q.A	Manufacturing	Product control	Purchase	Inventory control
Sales Service	 <pre> graph TD     Info[Info] --&gt; Claim[Claim]     Claim --&gt; Failure[Failure analysis]     Failure --&gt; Report[Analysis report]     Failure --&gt; Action[Corrective action]     Action --&gt; Tracking[Tracking]           </pre>							
Q.A Activity	1. ISO 9001 Maintenance Activities 3. Equipment calibration 5. Standardization Management				2. Process improvement proposal 4. Education And Training Activities			

### 3.2. Inspection Specification

- ◆Scope: The document shall be applied to TFT-LCD Module for 3.5" -15" (Ver.B01).
- ◆Inspection Standard: MIL-STD-105E Table Normal Inspection Single Sampling Level II.
- ◆Equipment: Gauge, MIL-STD, Powertip Tester, Sample
- ◆Defect Level: Major Defect AQL: 0.4; Minor Defect AQL: 1.5
- ◆OUT Going Defect Level: Sampling.
- ◆Standard of the product appearance test:

a. Manner of appearance test:

- (1). The test best be under 20W×2 fluorescent light(about 300lux ~500lux)  
 , and distance of view must be at 30~40 cm.
- (2). The test direction is base on about around 45° of vertical line.

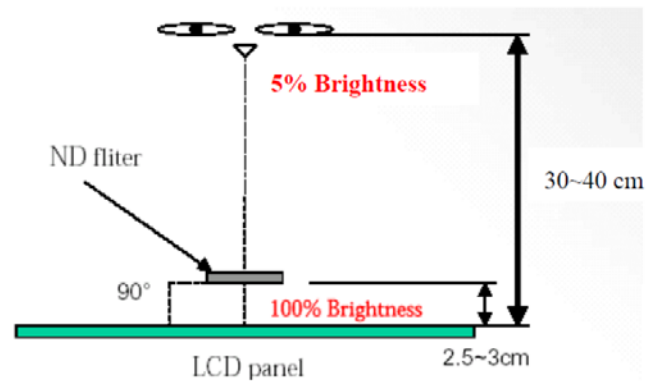
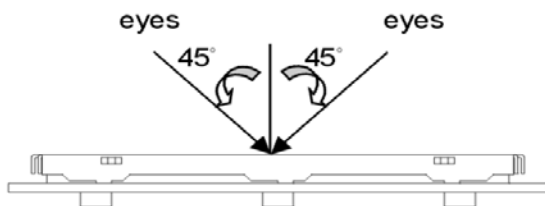

(3). Definition of area.

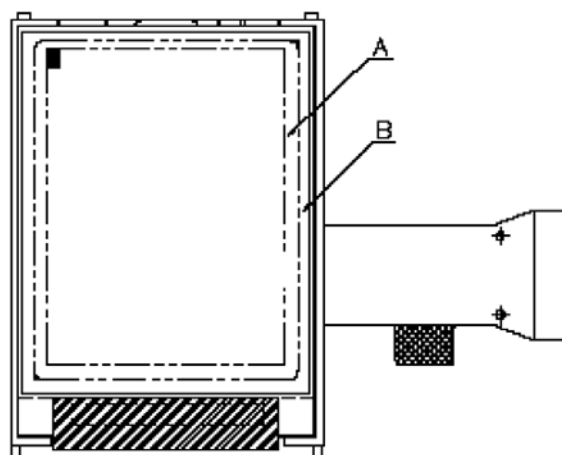

A area: viewing area  
 B area: Outside of viewing area

(4). Standard of inspection: (Unit : mm)

**◆Specification For TFT-LCD Module 3.5" ~15" :**

(Ver.B01)

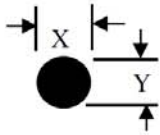
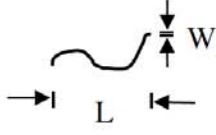

NO	Item	Criterion	Level												
01	Product condition	1. 1 The part number is inconsistent with work order of production.	Major												
		1. 2 Mixed product types.	Major												
		1. 3 Assembled in inverse direction.	Major												
02	Quantity	2. 1 The quantity is inconsistent with work order of production.	Major												
03	Outline dimension	3. 1 Product dimension and structure must conform to structure diagram.	Major												
04	Electrical Testing	4. 1 Missing line character and icon.	Major												
		4. 2 No function or no display.	Major												
		4. 3 Display malfunction.	Major												
		4. 4 LCD viewing angle defect.	Major												
		4. 5 Current consumption exceeds product specifications.	Major												
		4. 6 Mura can not be seen through 5% ND filter at 50% Gray, should be judged by the viewing angle of 90 degree.	Minor												
05	Dot defect (Bright dot, Dark dot)  On -display	<table border="1" style="margin-left: auto; margin-right: auto;"> <thead> <tr> <th colspan="2">Item</th> <th>Acceptance (Q'ty)</th> </tr> </thead> <tbody> <tr> <td rowspan="4" style="text-align: center; vertical-align: middle;">Dot Defect</td> <td style="text-align: center;">Bright Dot</td> <td style="text-align: center;"><math>\leq 4</math></td> </tr> <tr> <td style="text-align: center;">Dark Dot</td> <td style="text-align: center;"><math>\leq 5</math></td> </tr> <tr> <td style="text-align: center;">Joint Dot</td> <td style="text-align: center;"><math>\leq 3</math></td> </tr> <tr> <td style="text-align: center;">Total</td> <td style="text-align: center;"><math>\leq 7</math></td> </tr> </tbody> </table>	Item		Acceptance (Q'ty)	Dot Defect	Bright Dot	$\leq 4$	Dark Dot	$\leq 5$	Joint Dot	$\leq 3$	Total	$\leq 7$	Minor
		Item		Acceptance (Q'ty)											
Dot Defect	Bright Dot	$\leq 4$													
	Dark Dot	$\leq 5$													
	Joint Dot	$\leq 3$													
	Total	$\leq 7$													
5. 1 Inspection pattern: full white, full black, Red, Green and blue screens. 5. 2 It is defined as dot defect if defect area $> 1/2$ dot. 5. 3 The distance between two dot defect $\geq 5$ mm. 5. 4 Bright dot that can not be seen through 5% ND filter.															

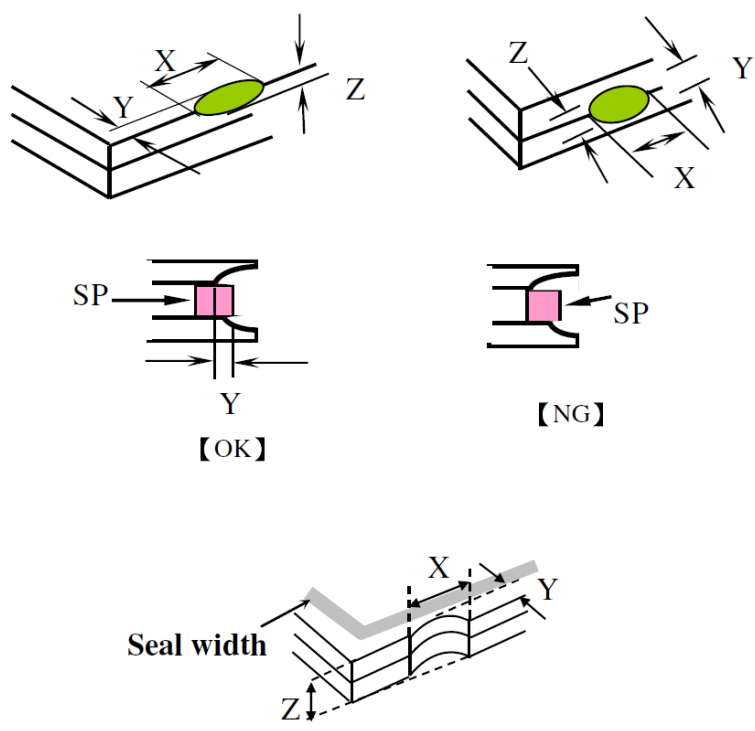
NO	Item	Criterion	Level																																												
06	Black or white Dot, scratch, contamination  Round type   $\Phi = (x + y) / 2$  Line type  	6. 1 Round type (Non-display or display):  <table border="1"> <thead> <tr> <th rowspan="2">Dimension (diameter : <math>\Phi</math>)</th> <th colspan="2">Acceptance (Q'ty)</th> </tr> <tr> <th>A area</th> <th>B area</th> </tr> </thead> <tbody> <tr> <td><math>\Phi \leq 0.25</math></td> <td colspan="2">Ignore</td> </tr> <tr> <td><math>0.25 &lt; \Phi \leq 0.50</math></td> <td>5</td> <td rowspan="3">Ignore</td> </tr> <tr> <td><math>\Phi &gt; 0.50</math></td> <td>0</td> </tr> <tr> <td><b>Total</b></td> <td>5</td> </tr> </tbody> </table>	Dimension (diameter : $\Phi$ )	Acceptance (Q'ty)		A area	B area	$\Phi \leq 0.25$	Ignore		$0.25 < \Phi \leq 0.50$	5	Ignore	$\Phi > 0.50$	0	<b>Total</b>	5	Minor																													
		Dimension (diameter : $\Phi$ )		Acceptance (Q'ty)																																											
A area	B area																																														
$\Phi \leq 0.25$	Ignore																																														
$0.25 < \Phi \leq 0.50$	5	Ignore																																													
$\Phi > 0.50$	0																																														
<b>Total</b>	5																																														
6. 2 Line type(Non-display or display):  <table border="1"> <thead> <tr> <th rowspan="2">module size</th> <th rowspan="2">Length (L)</th> <th rowspan="2">Width (W)</th> <th colspan="2">Acceptance (Q'ty)</th> </tr> <tr> <th>A area</th> <th>B area</th> </tr> </thead> <tbody> <tr> <td rowspan="5">3.5" to less 9"</td> <td>---</td> <td><math>W \leq 0.03</math></td> <td colspan="2">Ignore</td> </tr> <tr> <td><math>L \leq 10.0</math></td> <td><math>0.03 &lt; W \leq 0.05</math></td> <td>4</td> <td rowspan="3">Ignore</td> </tr> <tr> <td><math>L \leq 5.0</math></td> <td><math>0.05 &lt; W \leq 0.10</math></td> <td>2</td> </tr> <tr> <td>---</td> <td><math>W &gt; 0.10</math></td> <td colspan="2">As round type</td> </tr> <tr> <td colspan="3">Total</td> <td>5</td> <td></td> </tr> <tr> <td rowspan="4">9" to 15"</td> <td>---</td> <td><math>W \leq 0.05</math></td> <td colspan="2">Ignore</td> </tr> <tr> <td><math>L \leq 10.0</math></td> <td><math>0.05 &lt; W \leq 0.10</math></td> <td>5</td> <td rowspan="3">Ignore</td> </tr> <tr> <td>---</td> <td><math>W &gt; 0.10</math></td> <td colspan="2">As round type</td> </tr> <tr> <td colspan="3">Total</td> <td>5</td> <td></td> </tr> </tbody> </table>	module size	Length (L)	Width (W)	Acceptance (Q'ty)		A area	B area	3.5" to less 9"	---	$W \leq 0.03$	Ignore		$L \leq 10.0$	$0.03 < W \leq 0.05$	4	Ignore	$L \leq 5.0$	$0.05 < W \leq 0.10$	2	---	$W > 0.10$	As round type		Total			5		9" to 15"	---	$W \leq 0.05$	Ignore		$L \leq 10.0$	$0.05 < W \leq 0.10$	5	Ignore	---	$W > 0.10$	As round type		Total			5		
module size				Length (L)	Width (W)	Acceptance (Q'ty)																																									
	A area	B area																																													
3.5" to less 9"	---	$W \leq 0.03$	Ignore																																												
	$L \leq 10.0$	$0.03 < W \leq 0.05$	4	Ignore																																											
	$L \leq 5.0$	$0.05 < W \leq 0.10$	2																																												
	---	$W > 0.10$	As round type																																												
	Total			5																																											
9" to 15"	---	$W \leq 0.05$	Ignore																																												
	$L \leq 10.0$	$0.05 < W \leq 0.10$	5	Ignore																																											
	---	$W > 0.10$	As round type																																												
	Total				5																																										
07	Polarizer Bubble	<table border="1"> <thead> <tr> <th rowspan="2">Dimension (diameter: <math>\Phi</math>)</th> <th colspan="2">Acceptance (Q'ty)</th> </tr> <tr> <th>A area</th> <th>B area</th> </tr> </thead> <tbody> <tr> <td><math>\Phi \leq 0.25</math></td> <td colspan="2">Ignore</td> </tr> <tr> <td><math>0.25 &lt; \Phi \leq 0.50</math></td> <td>4</td> <td rowspan="4">Ignore</td> </tr> <tr> <td><math>0.50 &lt; \Phi \leq 0.80</math></td> <td>1</td> </tr> <tr> <td><math>\Phi &gt; 0.80</math></td> <td>0</td> </tr> <tr> <td><b>Total</b></td> <td>5</td> </tr> </tbody> </table>	Dimension (diameter: $\Phi$ )	Acceptance (Q'ty)		A area	B area	$\Phi \leq 0.25$	Ignore		$0.25 < \Phi \leq 0.50$	4	Ignore	$0.50 < \Phi \leq 0.80$	1	$\Phi > 0.80$	0	<b>Total</b>	5	Minor																											
Dimension (diameter: $\Phi$ )	Acceptance (Q'ty)																																														
	A area	B area																																													
$\Phi \leq 0.25$	Ignore																																														
$0.25 < \Phi \leq 0.50$	4	Ignore																																													
$0.50 < \Phi \leq 0.80$	1																																														
$\Phi > 0.80$	0																																														
<b>Total</b>	5																																														

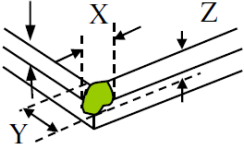
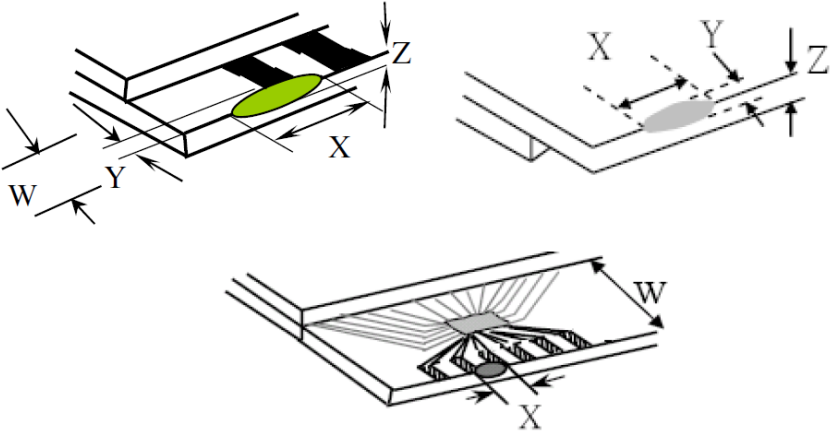
NO	Item	Criterion	Level						
08	The crack of glass	<p><b>Symbols :</b></p> <p><b>X:</b> The length of crack  <b>Z:</b> The thickness of crack  <b>t:</b> The thickness of glass</p> <p><b>Y:</b> The width of crack.  <b>W:</b> terminal length  <b>a:</b> LCD side length</p>	Minor						
		<p><b>8.1 General glass chip:</b></p> <p><b>8.1.1 Chip on panel surface and crack between panels:</b></p> <div style="text-align: center;">  </div> <table border="1" style="margin-left: auto; margin-right: auto;"> <thead> <tr> <th>X</th> <th>Y</th> <th>Z</th> </tr> </thead> <tbody> <tr> <td><math>\leq a</math></td> <td>Crack can't enter viewing area</td> <td><math>\leq 1/2 t</math></td> </tr> <tr> <td><math>\leq a</math></td> <td>Crack can't exceed the half of SP width.</td> <td><math>1/2 t &lt; Z \leq 2 t</math></td> </tr> </tbody> </table>		X	Y	Z	$\leq a$	Crack can't enter viewing area	$\leq 1/2 t$
X	Y	Z							
$\leq a$	Crack can't enter viewing area	$\leq 1/2 t$							
$\leq a$	Crack can't exceed the half of SP width.	$1/2 t < Z \leq 2 t$							

NO	Item	Criterion	Level												
		<p><b>Symbols:</b></p> <p><b>X:</b> The length of crack  <b>Z:</b> The thickness of crack  <b>t:</b> The thickness of glass</p> <p><b>Y:</b> The width of crack.  <b>W:</b> terminal length  <b>a:</b> LCD side length</p> <hr/> <p><b>8.1.2 Corner crack:</b></p>  <table border="1" data-bbox="523 757 1334 1048"> <thead> <tr> <th>X</th> <th>Y</th> <th>Z</th> </tr> </thead> <tbody> <tr> <td><math>\leq 1/5 a</math></td> <td>Crack can't enter viewing area</td> <td><math>Z \leq 1/2 t</math></td> </tr> <tr> <td><math>\leq 1/5 a</math></td> <td>Crack can't exceed the half of SP width.</td> <td><math>1/2 t &lt; Z \leq 2 t</math></td> </tr> </tbody> </table>	X	Y	Z	$\leq 1/5 a$	Crack can't enter viewing area	$Z \leq 1/2 t$	$\leq 1/5 a$	Crack can't exceed the half of SP width.	$1/2 t < Z \leq 2 t$				
X	Y	Z													
$\leq 1/5 a$	Crack can't enter viewing area	$Z \leq 1/2 t$													
$\leq 1/5 a$	Crack can't exceed the half of SP width.	$1/2 t < Z \leq 2 t$													
08	The crack of glass	<p><b>8.2 Protrusion over terminal:</b></p> <p><b>8.2.1 Chip on electrode pad:</b></p>  <table border="1" data-bbox="560 1682 1342 1850"> <thead> <tr> <th></th> <th>X</th> <th>Y</th> <th>Z</th> </tr> </thead> <tbody> <tr> <td><b>Front</b></td> <td><math>\leq a</math></td> <td><math>\leq 1/2 W</math></td> <td><math>\leq t</math></td> </tr> <tr> <td><b>Back</b></td> <td><math>\leq a</math></td> <td><math>\leq W</math></td> <td><math>\leq 1/2 t</math></td> </tr> </tbody> </table>		X	Y	Z	<b>Front</b>	$\leq a$	$\leq 1/2 W$	$\leq t$	<b>Back</b>	$\leq a$	$\leq W$	$\leq 1/2 t$	Minor
	X	Y	Z												
<b>Front</b>	$\leq a$	$\leq 1/2 W$	$\leq t$												
<b>Back</b>	$\leq a$	$\leq W$	$\leq 1/2 t$												

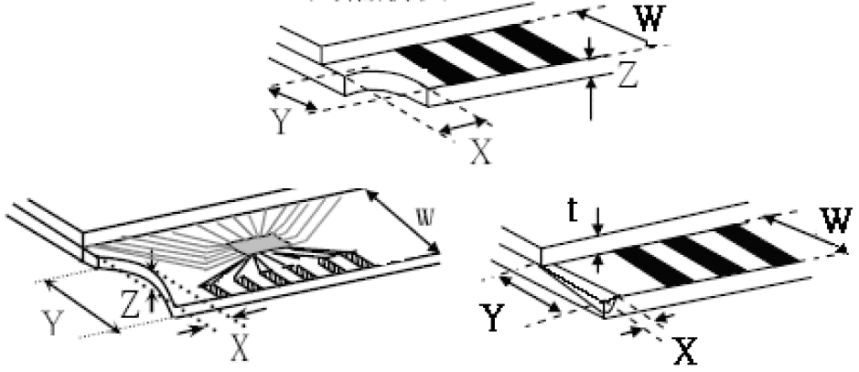
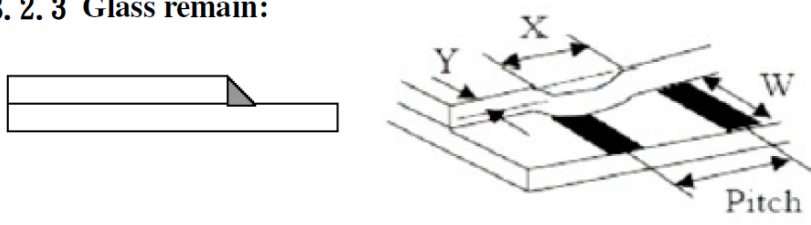

NO	Item	Criterion	Level												
08	The crack of glass	<p><b>Symbols:</b></p> <p><b>X:</b> The length of crack                      <b>Y:</b> The width of crack.  <b>Z:</b> The thickness of crack                <b>W:</b> terminal length  <b>t:</b> The thickness of glass                 <b>a:</b> LCD side length</p> <hr/> <p><b>8.2.2 Non-conductive portion:</b></p>  <table border="1" data-bbox="630 952 1252 1075"> <thead> <tr> <th>X</th> <th>Y</th> <th>Z</th> </tr> </thead> <tbody> <tr> <td><math>\leq 1/3 a</math></td> <td><math>\leq W</math></td> <td><math>\leq t</math></td> </tr> </tbody> </table> <p>⊙ If the chipped area touches the ITO terminal, over 2/3 of the ITO must remain and be inspected according to electrode terminal specifications.</p> <p><b>8.2.3 Glass remain:</b></p>  <table border="1" data-bbox="550 1489 1236 1612"> <thead> <tr> <th>X</th> <th>Y</th> <th>Z</th> </tr> </thead> <tbody> <tr> <td><math>\leq a</math></td> <td><math>\leq 1/3 W</math></td> <td><math>\leq t</math></td> </tr> </tbody> </table> <p><b>8.2.4 Cracking:</b></p>  <p><b>Not Allowed</b></p>	X	Y	Z	$\leq 1/3 a$	$\leq W$	$\leq t$	X	Y	Z	$\leq a$	$\leq 1/3 W$	$\leq t$	Minor
		X	Y	Z											
$\leq 1/3 a$	$\leq W$	$\leq t$													
X	Y	Z													
$\leq a$	$\leq 1/3 W$	$\leq t$													



**◆ Specification For TFT-LCD Module 3.5" ~15" :**
**(Ver.B01)**

NO	Item	Criterion	Level
09	Backlight elements	9. 1 Backlight can't work normally.	Major
		9. 2 Backlight doesn't light or color is wrong.	Major
		9. 3 Illumination source flickers when lit.	Major
10	General appearance	10. 1 Pin type 、 quantity 、 dimension must match type in structure diagram.	Major
		10. 2 No short circuits in components on PCB or FPC .	Major
		10. 3 Parts on PCB or FPC must be the same as on the production characteristic chart .There should be no wrong parts , missing parts or excess parts.	Major
		10. 4 Product packaging must the same as specified on packaging specification sheet.	Minor
		10. 5 The folding and peeled off in polarizer are not acceptable.	Minor
		10. 6 The PCB or FPC between B/L assembled distance(PCB or FPC ) is $\leq 1.5$ mm.	Minor



## 5. PRECAUTION RELATING PRODUCT HANDLING

### 5.1 SAFETY

- 5.1.1 If the LCD panel breaks , be careful not to get the liquid crystal to touch your skin.
- 5.1.2 If the liquid crystal touches your skin or clothes , please wash it off immediately by using soap and water.

### 5.2 HANDLING

- 5.2.1 Avoid any strong mechanical shock which can break the glass.
- 5.2.2 Avoid static electricity which can damage the CMOS LSI—When working with the module , be sure to ground your body and any electrical equipment you may be using.
- 5.2.3 Do not remove the panel or frame from the module.
- 5.2.4 The polarizing plate of the display is very fragile. So , please handle it very carefully ,do not touch , push or rub the exposed polarizing with anything harder than an HB pencil lead (glass , tweezers , etc.)
- 5.2.5 Do not wipe the polarizing plate with a dry cloth , as it may easily scratch the surface of plate.
- 5.2.6 Do not touch the display area with bare hands , this will stain the display area.
- 5.2.7 Do not use ketonics solvent & aromatic solvent. Use with a soft cloth soaked with a cleaning naphtha solvent.
- 5.2.8 To control temperature and time of soldering is  $320\pm 10^{\circ}\text{C}$  and 3-5 sec.
- 5.2.9 To avoid liquid (include organic solvent) stained on LCM .

### 5.3 STORAGE

- 5.3.1 Store the panel or module in a dark place where the temperature is  $25^{\circ}\text{C} \pm 5^{\circ}\text{C}$  and the humidity is below 65% RH.
- 5.3.2 Do not place the module near organics solvents or corrosive gases.
- 5.3.3 Do not crush , shake , or jolt the module.

### 5.4 TERMS OF WARRANTY

- 5.4.1 Applicable warrant period  
The period is within thirteen months since the date of shipping out under normal using and storage conditions.
- 5.4.2 Unaccepted responsibility  
This product has been manufactured to your company's specification as a part for use in your company's general electronic products. It is guaranteed to perform according to delivery specifications. For any other use apart from general electronic equipment , we cannot take responsibility if the product is used in nuclear power control equipment , aerospace equipment , fire and security systems or any other applications in which there is a direct risk to human life and where extremely high levels of reliability are required.

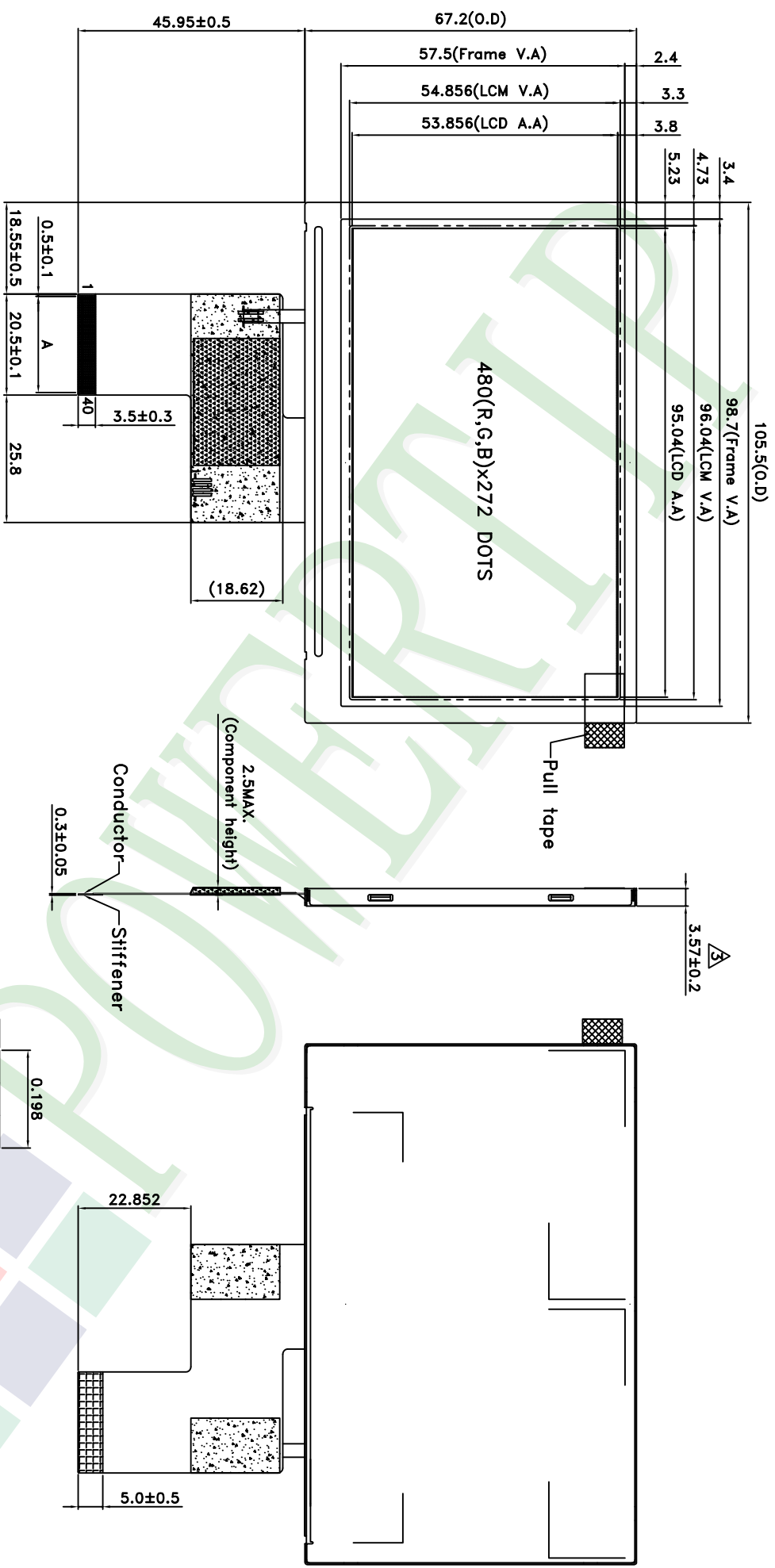

- NOTES:
- LCD TYPE: TFT LCD
  - LCD DISPLAY: Normally Black/TRANSMISSIVE
  - The tolerance unless classified ±0.3mm
  - A: P0.5\*39=19.5±0.05 ; W=0.35±0.05
  - FPC suggested connector : (HIROSE) FH34SRJ-40S-0.5SH(50)
  - ⊞: Kapton tape; ⊞: Component area&Unbending area

007					
006					
005					
004					
003	Modify the thickness of LCM	Lauren	2019/9/19		
002	Add dimensions	Lauren	2019/9/10		
001	NEW DRAWING	Lauren	2019/6/25		
REV		REV BY		REVISER	DATE

PART NO: PH480272T016-ZBA  
 DRAWING NAME: LMD-PH480272T016-ZBA  
 TITLE: LCD MODULE DRAWING

Design		Lauren Chien		Surface		Precision Level	
Check		Tina Chen		Material		1 ~ 4	
Approve		Rex Liao		Thickness		4 ~ 16	
				Quantity		16 ~ 63	
						63 ~ 250	
						250 ~ 1000	

久正光電股份有限公司  
 POWER TIP TECHNOLOGY CORPORATION

Unit: MM  
 Scale: FIT  
 Page: 1/1

# LCM包裝規格書

## LCM Packaging Specifications (For Tray)

Approve	Check	Contact
Rex	Clare	Lauren

Documents NO. PKG-PH480272T016-ZBA

### 1. 包裝材料規格表 (Packaging Material) : (per carton)

No.	Item	Model	Dimensions (mm)	1Pcs Weight	Quantity	Total Weight
1	成品 (LCM)	PH480272T016-ZBA	105.5 X 67.2X3.57	0.052	144	7.49
2	多層薄膜(1)POF	OTFILM0BA03ABA	19"X350X0.015	—	6	—
3	TRAY 盤 (2)Tray	TYSG000000202	352 X 260 X 13.1	0.1	42	4.2
4	內盒(3)Product Box	BX36627063ABBA	383 X 270 X 66	0.182	6	1.092
5	保利龍板(4)Polylon board	OTPLB00PL08ABA	550 X 393 X 20	0.0284	2	0.0568
6	外紙箱(5)Carton	BX57041027CCBA	570 X 410 X 265	1.0	1	1.0
7						
8						
9						

2. 一整箱總重量 (Total LCD Weight in carton) : 13.84 Kg±10%

3. 單箱數量規格表 (Packaging Specifications and Quantity) :

(1) LCM quantity per box : no per tray	4	x no of tray	6	=	24
(2) Total LCM quantity in carton : quantity per box	24	x no of boxes	6	=	144

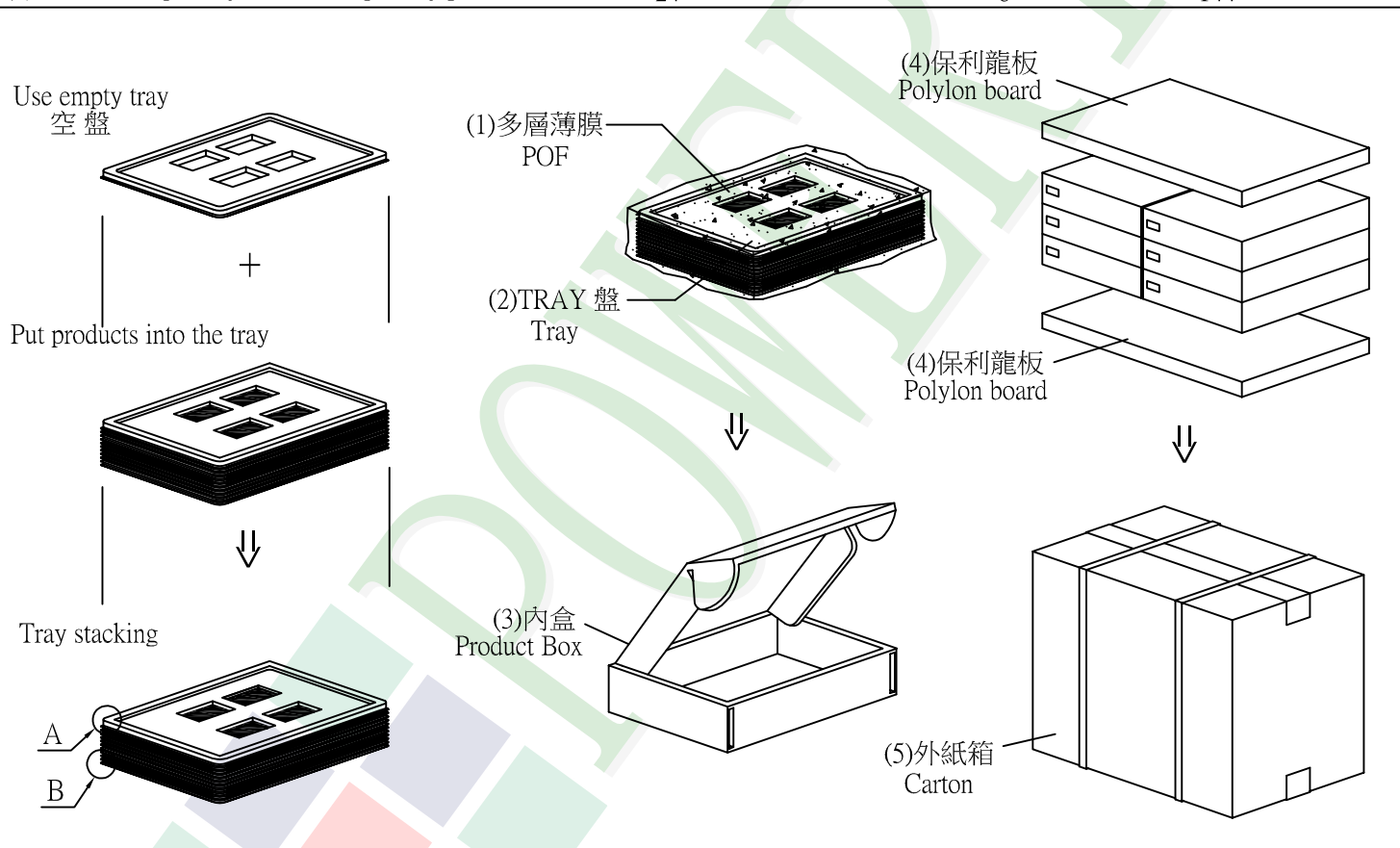

### 特記事項 (REMARK)

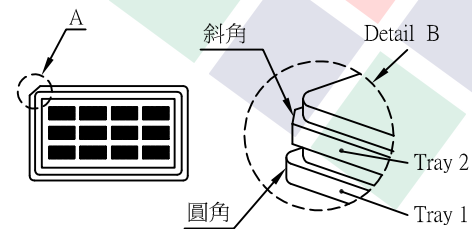

4. TRAY盤相疊時, 需旋轉180度, 請詳見B視圖  
 Rotate tray 180 degrees and place on top of stack.  
 Check the tray stack using Fig. B.