



SPECIFICATIONS

CUSTOMER : _____

SAMPLE CODE : SH320240T028-ZEA01

MASS PRODUCTION CODE : PH320240T028-ZEA01

SAMPLE VERSION : 01

SPECIFICATIONS EDITION : 004

DRAWING NO. (Ver.) : LMD-PH320240T028-ZEA01 (Ver.001)

PACKAGING NO. (Ver.) : PKG-PH320240T028-ZEA01 (Ver.001)

Customer Approved

Date:

Approved	Checked	Designer
廖志豪 Rex Liao	張慶源 Yuan Chang	陳宗淇 Howard Chen

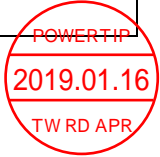

- Preliminary specification for design input
- Specification for sample approval

POWERTIP TECH. CORP.

Headquarters:

No.8, 6th Road, Taichung Industrial Park,
Taichung, Taiwan
台中市 407 工業區六路 8 號

TEL: 886-4-2355-8168
FAX: 886-4-2355-8166

E-mail: sales@powertip.com.tw
Http://www.powertip.com.tw

Contents

1. SPECIFICATIONS

- 1.1 Features
- 1.2 Mechanical Specifications
- 1.3 Absolute Maximum Ratings
- 1.4 DC Electrical Characteristics
- 1.5 Optical Characteristics
- 1.6 Backlight Characteristics

2. MODULE STRUCTURE

- 2.1 Counter Drawing
- 2.2 Interface Pin Description
- 2.3 Timing Characteristics

3. QUALITY ASSURANCE SYSTEM

- 3.1 Quality Assurance Flow Chart
- 3.2 Inspection Specification

4. RELIABILITY TEST

- 4.1 Reliability Test Condition

5. PRECAUTION RELATING PRODUCT HANDLING

- 5.1 Safety
- 5.2 Handling
- 5.3 Storage
- 5.4 Terms of Warranty

Appendix : 1.LCM Drawing

2. Packing Specification

Note : For detailed information please refer to IC data sheet :

Primacy(TFT LCD): Sitronix: ST7272A

1. SPECIFICATIONS

1.1 Features

Item	Standard Value
Display Type	320 * 3 (RGB) *240 Dots
LCD Type	Full Viewing Angle , Normally Black , Transmissive type
Screen size(inch)	3.5 inch
Color configuration	RGB-Strip
Backlight Type	White LED B/L
Interface	24-bits RGB Interface
Other(controller/driver IC)	ST7272A (Or Compatible IC)
ROHS	THIS PRODUCT CONFORMS THE ROHS OF PTC Detail information please refer website : http://www.powertip.com.tw/news_detail.php?Key=1&cID=1

1.2 Mechanical Specifications

Item	Standard Value	Unit
Outline Dimension	76.9(W) * 63.9(L) * 3.2(H)	mm

LCD Panel

Item	Standard Value	Unit
Active Area	70.08(W) * 52.56(L)	mm
Pixel Size	0.219(W) * 0.219(H)	mm

Note : For detailed information please refer to LCM drawing

1.3 Absolute Maximum Ratings

Module

Item	Symbol	Condition	Min.	Max.	Unit
System Power Supply Voltage	VCC	GND=0	-0.3	4.0	V
	VCI	GND=0	-0.3	4.0	V
Operating Temperature	T _{OP}	-	-30	85	°C
Storage Temperature	T _{ST}	-	-40	85	°C
Storage Humidity	H _D	T _a ≤ 60 °C	10	90	%RH

1.4 DC Electrical Characteristics

Module

GND = 0V, T_a = 25 °C

Item	Symbol	Condition	Min.	Typ.	Max.	Unit
Power Supply Voltage	VDD	-	-	3.3	-	V
	VCI	-	-	3.3	-	V
Input H/L Level Voltage	V _{IH}	-	0.7V _{CI}	-	V _{CI}	V
	V _{IL}	-	GND	-	0.3V _{CI}	V
Supply Current	I _{dd}	VCC&VCI =3.3 V Pattern= Picture	-	20	-	mA
		VCC &VCI=3.3V Pattern= White *1	-	25	40	mA

Note1:Maximum current display

1.5 Optical Characteristics

TFT LCD Module

VDD&VCI = 3.3 V, Ta=25°C

Item	Symbol		Condition	Min.	Typ.	Max.	unit	
Response time	Tr+Tf		Ta = 25°C θX, θY = 0°	-	30	40	ms	Note 2
Viewing angle	Top	θY+	CR ≥ 10	-	80	-	Deg.	Note 4
	Bottom	θY-		-	80	-		
	Left	θX-		-	80	-		
	Right	θX+		-	80	-		
Contrast ratio		CR		500	600	-		Note 3
Color of CIE Coordinate (With B/L)	White	X	Ta = 25°C θX , θY = 0°	0.28	0.33	0.38	-	Note1
		Y		0.32	0.37	0.42		
	Red	X		0.59	0.64	0.69		
		Y		0.30	0.35	0.40		
	Green	X		0.31	0.36	0.41		
		Y		0.55	0.60	0.65		
	Blue	X		0.09	0.14	0.19		
		Y		0.05	0.10	0.15		
Average Brightness Pattern=white display (With LCD)*1	IF		IF= 20 mA	250	300	-	cd/m ²	Note1
Uniformity (With LCD)*2	ΔB		IF=20 mA	70	-	-	%	Note1

Note 1:

*1 : $\Delta B = B(\min) / B(\max) * 100\%$

*2 : Measurement Condition for Optical Characteristics:

a : Environment: $25^{\circ}\text{C} \pm 5^{\circ}\text{C}$ / $60 \pm 20\%$ R.H , no wind , dark room below 10 Lux at typical lamp current and typical operating frequency.

b : Measurement Distance: 500 ± 50 mm , ($\theta = 0^{\circ}$)

c : Equipment: TOPCON BM-7 fast , (field 1°) , after 10 minutes operation.

d : The uncertainty of the C.I.E coordinate measurement ± 0.01 , Average Brightness $\pm 4\%$

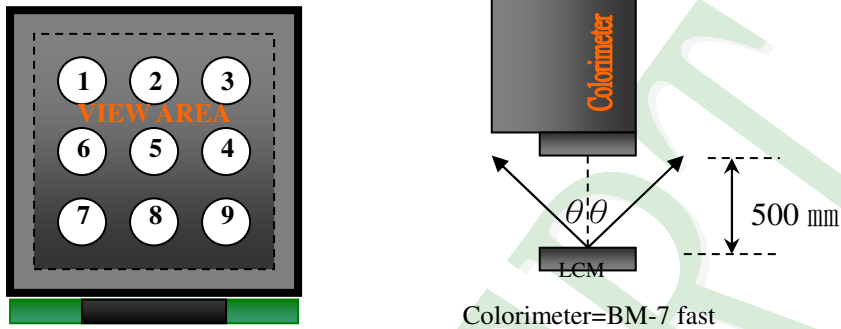

To be measured at the center area of panel with a viewing cone of 1° by Topcon luminance meter BM-7, after 10 minutes operation (module)

Note2: Definition of response time:

The output signals of photo detector are measured when the input signals are changed from "black" to "white"(falling time) and from "white" to "black"(rising time), respectively. The response time is defined as the time interval between the 10% and 90% of Amplitudes.

Refer to figure as below:

Normally White



Normally Black

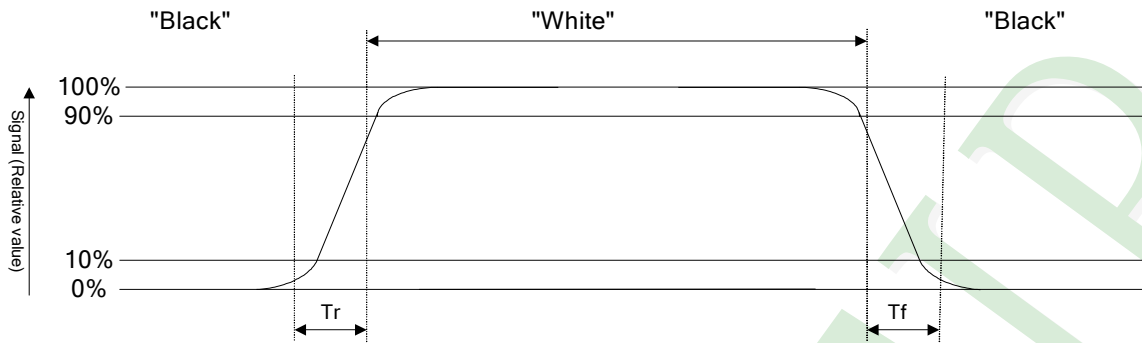

Note3: Definition of contrast ratio:

Contrast ratio is calculated with the following formula

$$\text{Contrast ratio (CR)} = \frac{\text{Photo detector output when LCD is at "White" state}}{\text{Photo detector output when LCD is at "Black" state}}$$

Note4: Definition of viewing angle:

Refer to figure as below:

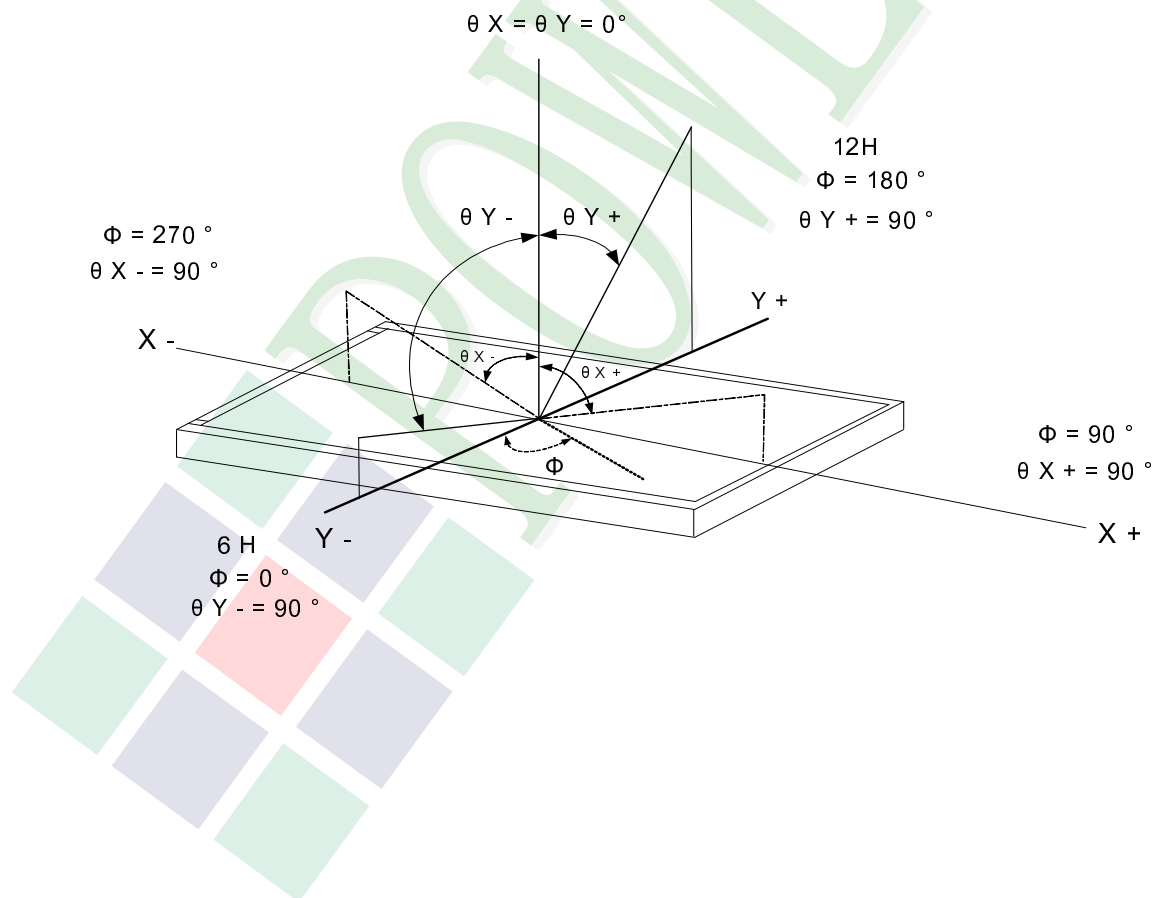

1.6 Backlight Characteristics

Maximum Ratings

Item	Symbol	Conditions	Min.	Max.	Unit
LED Forward Current (Each LED)	IF	Ta =25°C	-	30	mA
LED Reverse Voltage (Each LED)	VR		-	5	V
Power consumption	Pd			396	mW

Electrical / Optical Characteristics

Item	Symbol	Conditions	Min.	Typ.	Max.	Unit
Forward Voltage	VF	If= 20mA	18	19	19.8	V
Average Brightness (Without LCD)	IV		4100	5000	6700	cd/m ²
CIE Color Coordinate (Without LCD)	X		-	0.31	-	-
	Y		-	0.32	-	
Color	White					

B/L Internal Circuit Diagram:

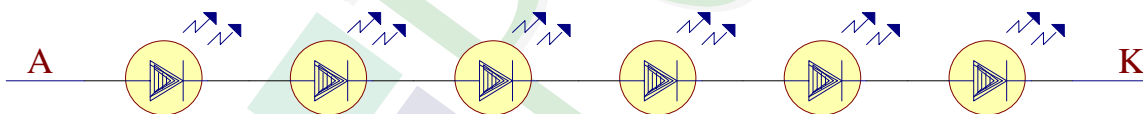

Other Description

Item	Conditions	Description
Life Time	Ta =25°C IF= 20mA	50,000 hrs

2. MODULE STRUCTURE

2.1 Counter Drawing

2.1.1 LCM Mechanical Diagram

* See Appendix

2.1.2 Block Diagram

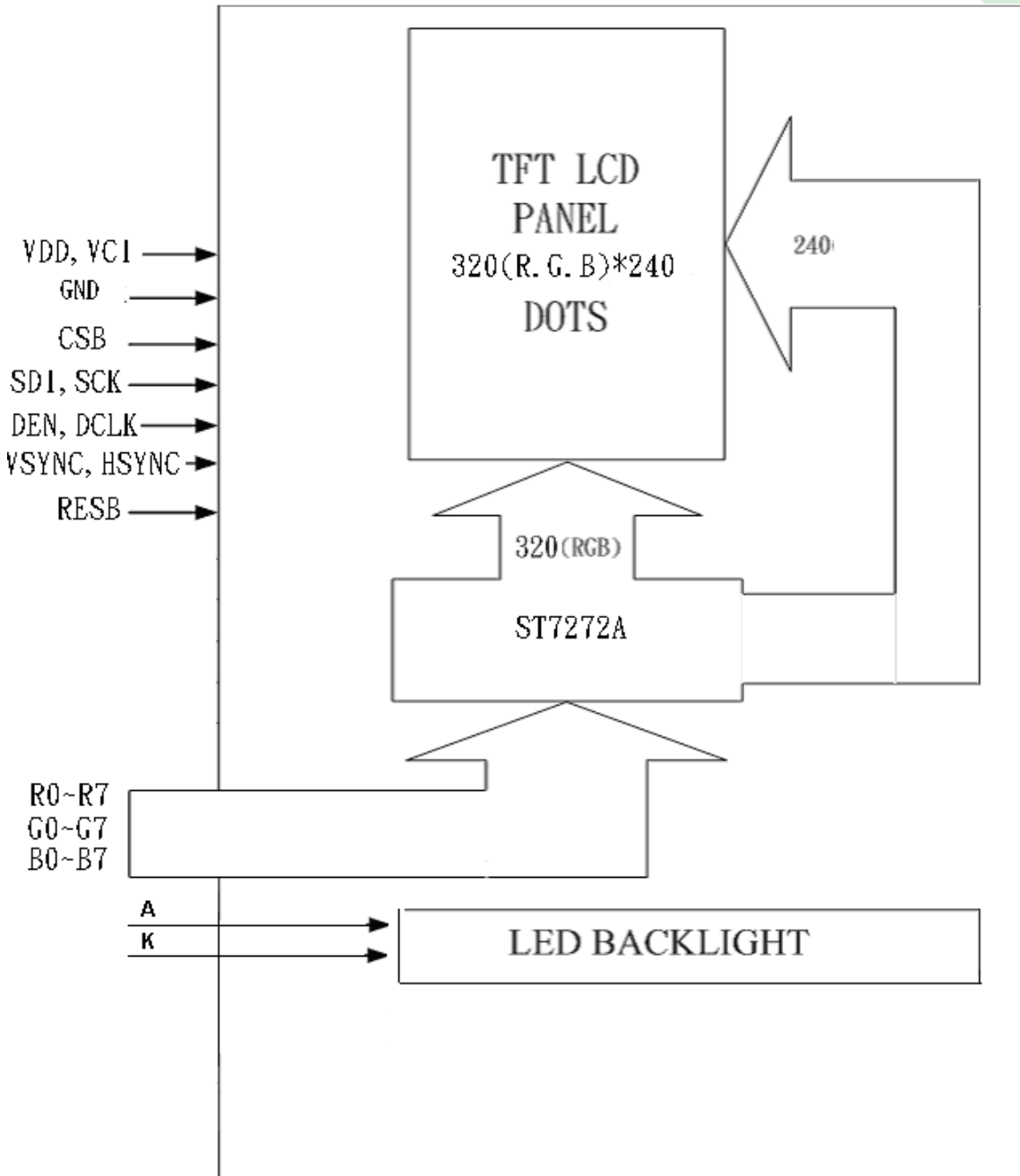

2.2 Interface Pin Description

Pin No.	Symbol	Function
1	A	LED Anode.
2	K	LED Cathode.
3	GND	Ground.
4	VCI	Analog Power Supply Voltage.
5	NC	Not Used.
6	VDD	Digital Power Supply Voltage.
7	GND	Ground.
8	RESB	Reset.
9	CSB	Chip select Input: CSB = L - selected and accessible. CSB = H - is not selected and not accessible.
10	SCK	SPI Clock Input.
11	NC	Not Used.
12	SDI	SPI Data Input. The data is latched on the rising edge of the SCK signal.
13	GND	Ground.
14	B0	Graphic display Blue data.
15	B1	
16	B2	
17	B3	
18	B4	
19	B5	
20	B6	
21	B7	
22	G0	Graphic display Green data.
23	G1	
24	G2	
25	G3	

Pin No.	Symbol	Function
26	G4	Graphic display Green data.
27	G5	
28	G6	
29	G7	
30	R0	Graphic display Red data.
31	R1	
32	R2	
33	R3	
34	R4	
35	R5	
36	R6	
37	R7	
38	GND	Ground.
39	DCLK	Video Clock Input. The data is latched on the rising edge of DCLK. See Note 1
40	HSYNC	Horizontal Sync Input. See Note 1
41	VSYNC	Vertical Sync Input. See Note 1
42	DEN	Data input enable. Display access is enabled when DE is "H". See Note 1
43	GND	Ground.
44	NC	Not Used.
45	NC	Not Used.
46	NC	Not Used.
47	Y+	Touch Panel Y_Top. (NC)
48	X+	Touch Panel X_Right.(NC)
49	Y-	Touch Panel Y_Bottom. (NC)
50	X-	Touch Panel X_Left. (NC)

Note 1

RGB Mode Selection Table	DCLK	HSYNC	VSYNC	DE
SYNC - DE Mode	Input	Input	Input	Input
SYNC Mode	Input	Input	Input	GND
DE Mode	Input	GND	GND	Input

*: "Input" means these signals are driven by host side

2.3 Timing Characteristics

2.3.1 System Bus Timing for RGB Interface

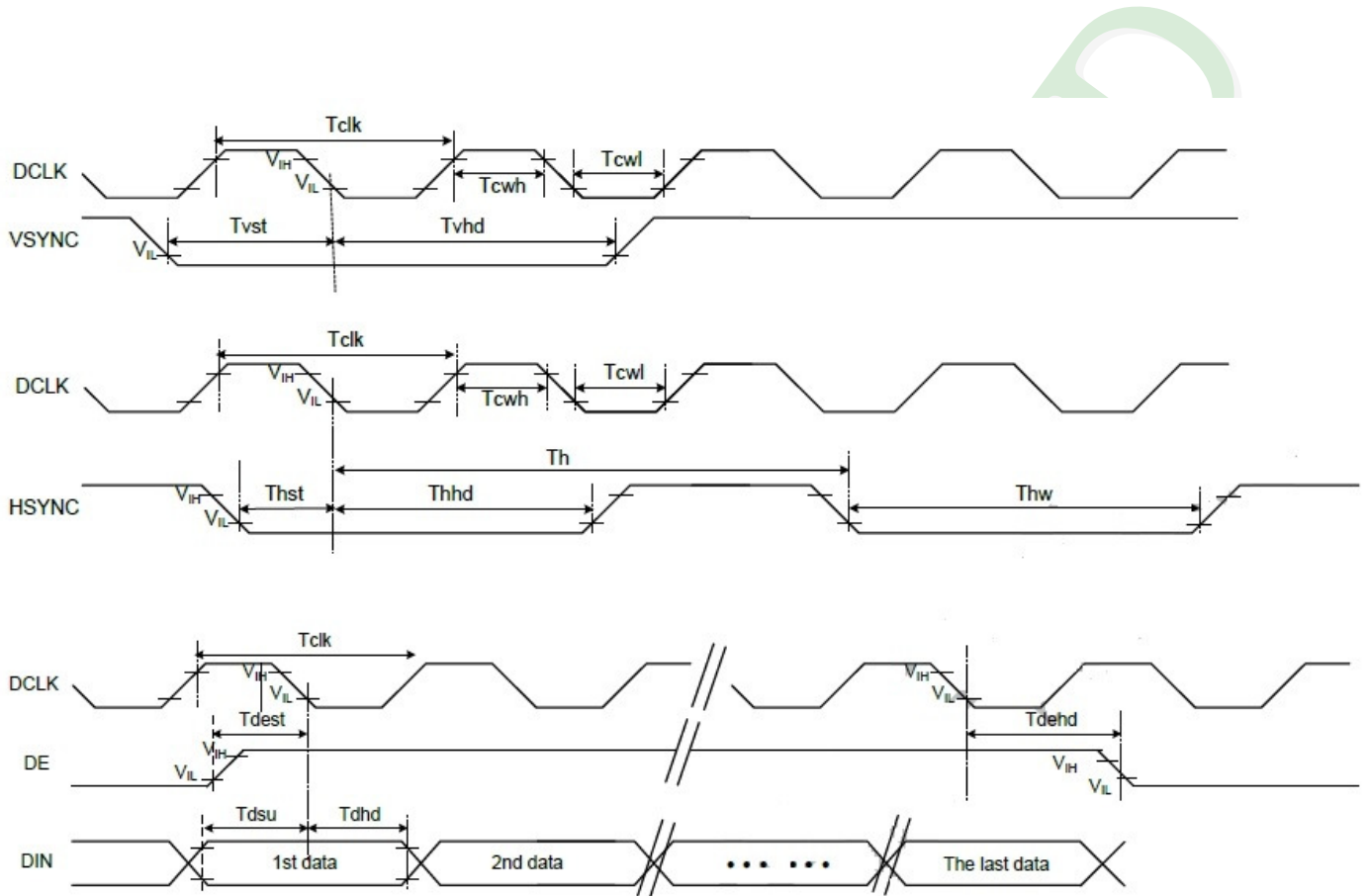

VDD= 3.3V, Ta=25°C

Item	Symbol	Min	Typ.	Max	Unit	Conditions
CLK Pulse Duty	T_{clk}	40	50	60	%	
HSYNC Width	T_{hw}	2	-	-	DCLK	
HSYNC Period	T_h	55	60	65	us	
VSYNC Setup Time	T_{vst}	12	-	-	ns	
VSYNC Hold Time	T_{vhd}	12	-	-	ns	
HSYNC Setup Time	T_{hst}	12	-	-	ns	
HSYNC Hold Time	T_{hhd}	12	-	-	ns	
Data Setup Time	T_{dsu}	12	-	-	ns	
Data Hold Time	T_{dhd}	12	-	-	ns	
DE Setup Time	T_{dest}	12	-	-	ns	
DE Hold Time	T_{dehd}	12	-	-	ns	

2.3.2 Parallel RGB SYNC Mode

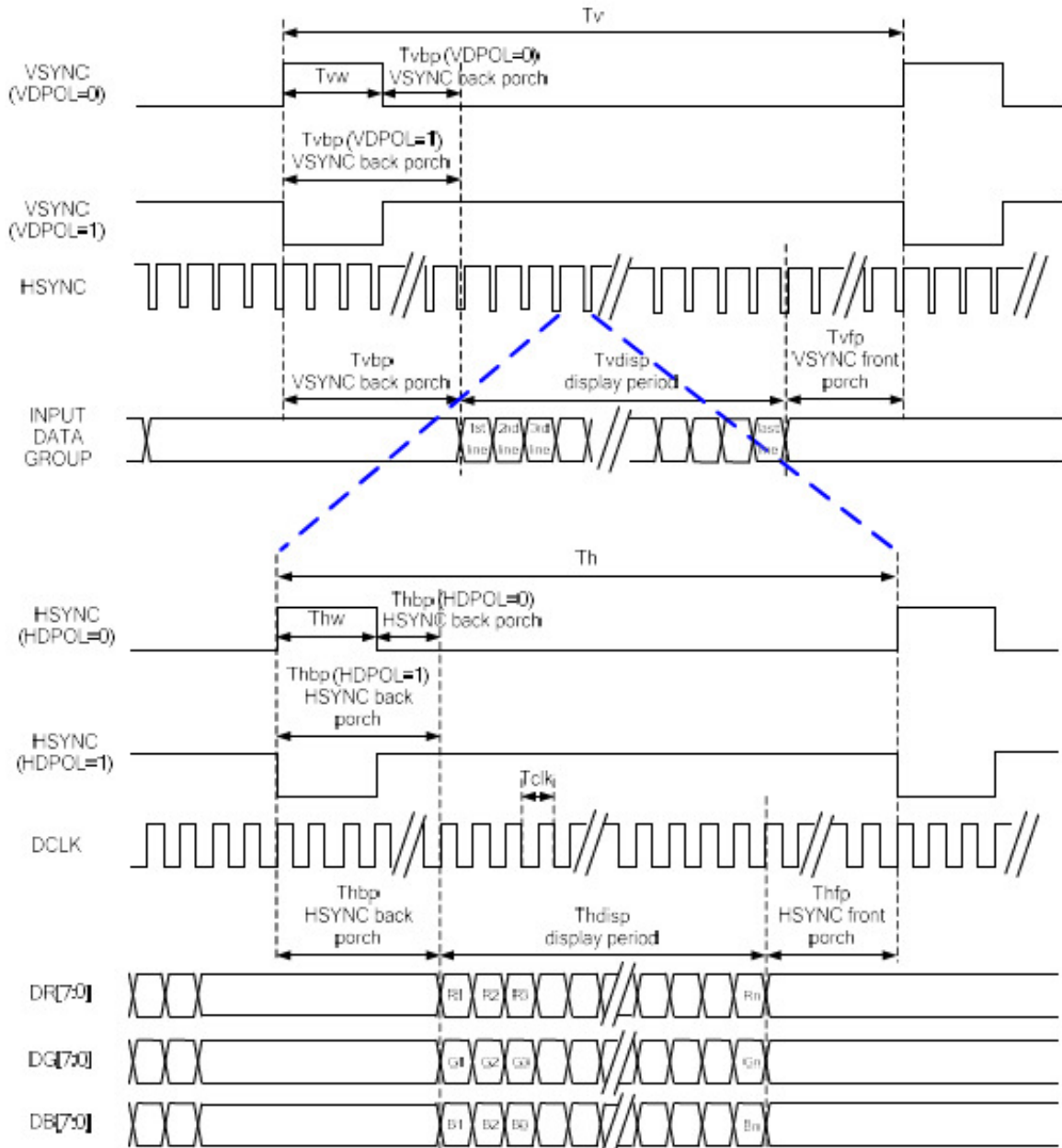

2.3.3 Parallel RGB SYNC-DE Mode

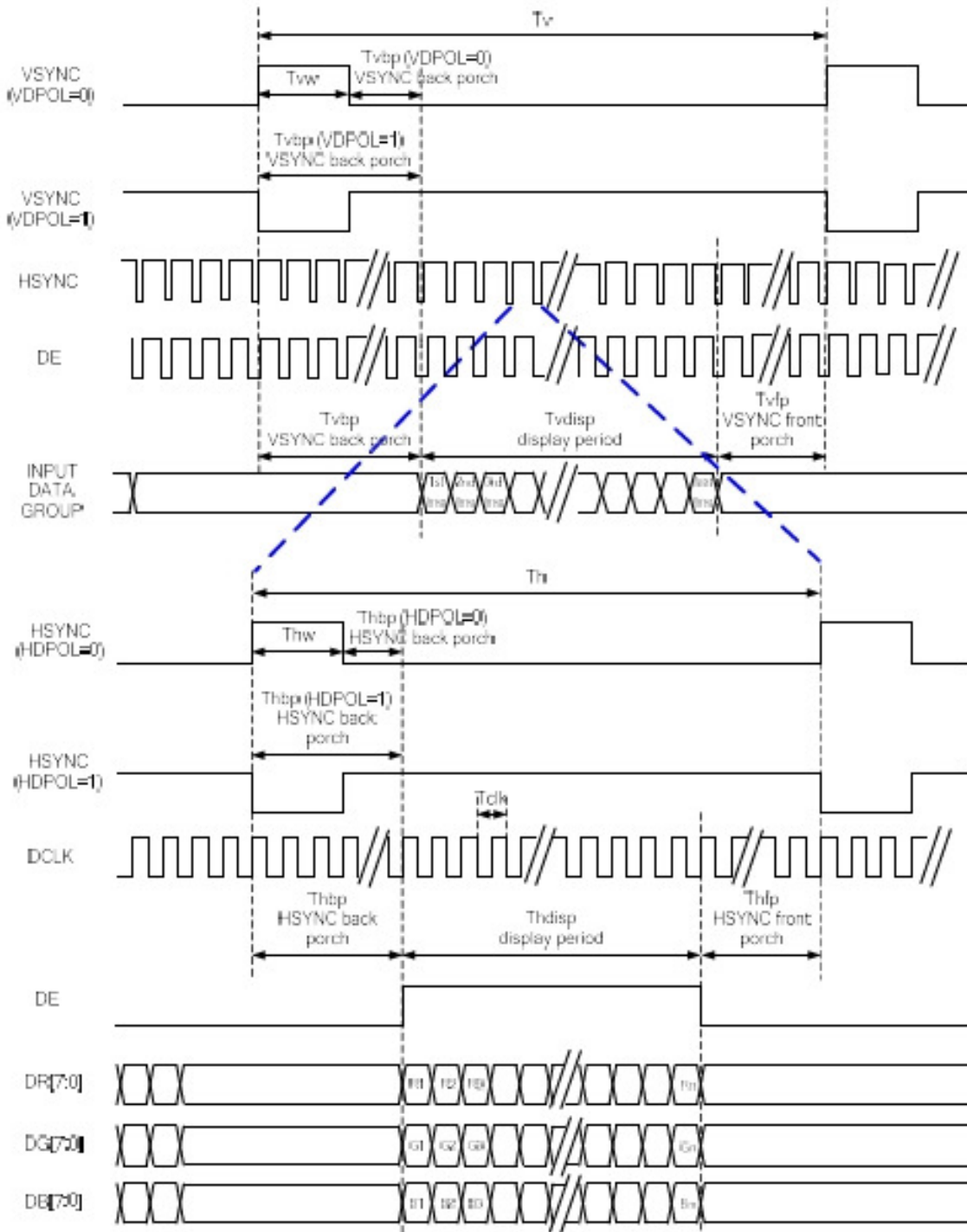

2.3.4 Parallel RGB DE Mode

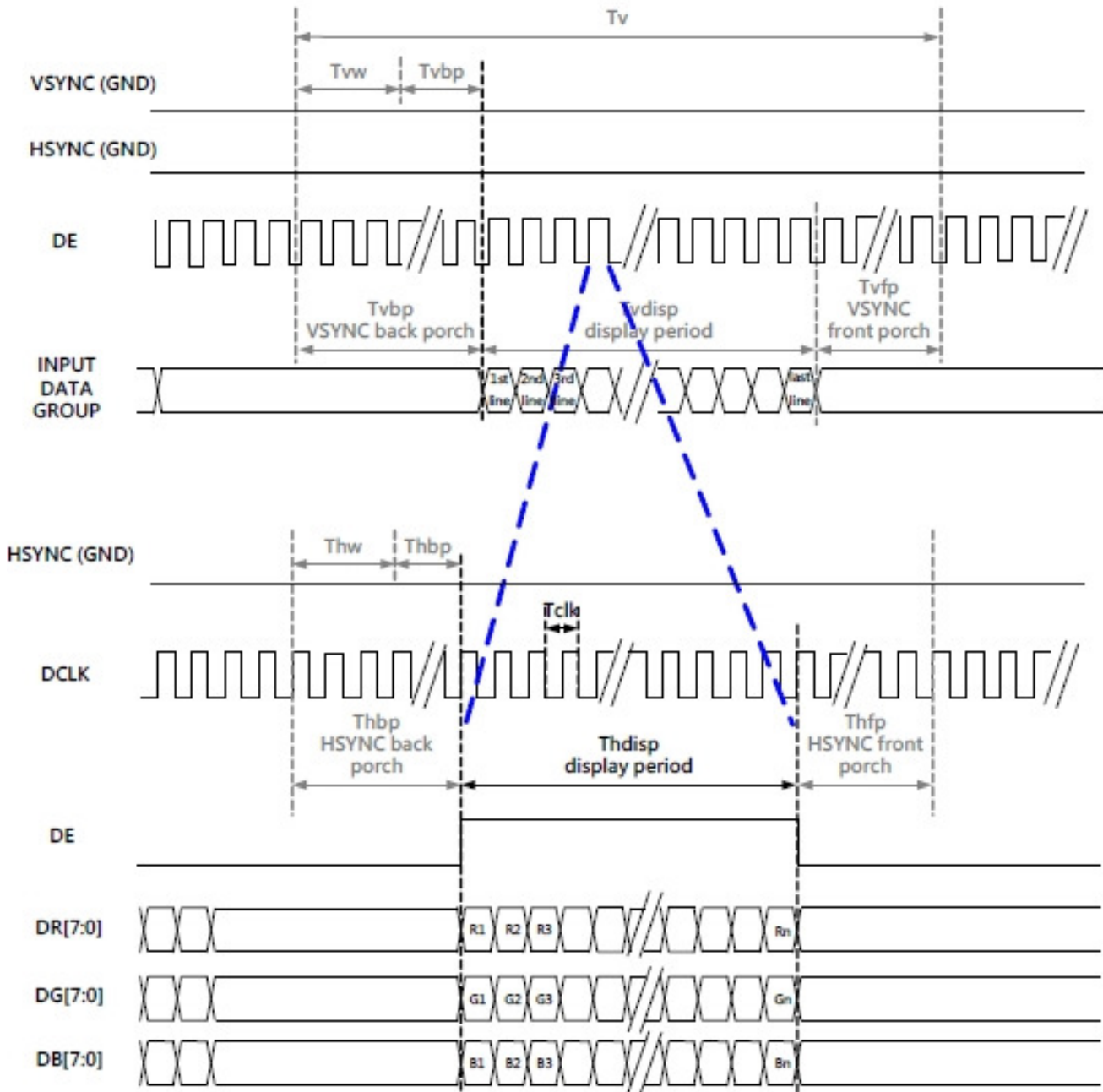

2.3.5 Parallel RGB Input Timing Table

Parallel 24-bit RGB Input Timing Table							
Parameter	Symbol	Min	Typ	Max	Unit	Note	
DCLK frequency	Fclk	5	6	8	MHz		
DCLK Period	Tclk	125	167	200	ns		
HSYNC	Period Time	Th	325	371	438	DCLK	SYNC mode back porch control by H_BLANKING[7:0] setting Thbp= H_BLANKING[7:0]
	Display Period	Thdisp		320			
	Back Porch	Thbp	3	43	43		
	Front Porch	Thfb	2	8	75		
	Pulse Width	Thw	2	4	43		
VSYNC	Period Time	Tv	244	260	289	HSYNC	SYNC mode back porch control by V_BLANKING[7:0] setting Thbp= V_BLANKING[7:0]
	Display Period	Tvdisp		240			
	Back Porch	Tvbp	2	12	12		
	Front Porch	Tvfb	2	8	37		
	Pulse Width	Tvw	2	4	12		

2.3.10 POWER ON/OFF SEQUENCE

Power ON Sequence

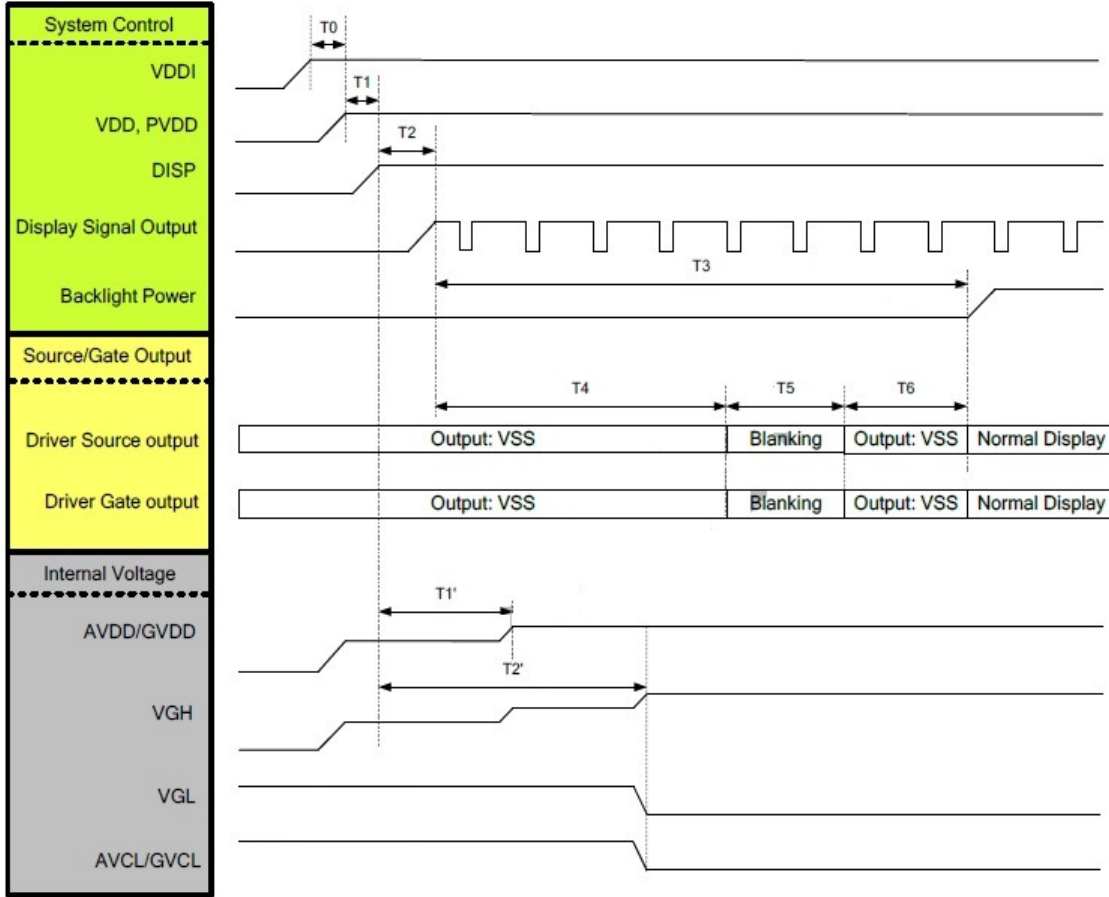

Symbol	Description	Min. Time	Unit
T0	Analog power on delay time	0	ms
T1	System power stability to DISP= "High"	0	ms
T2	DISP= "High" to display signal output	10	ms
T3	Display signal output to backlight power on	250	ms
T4	Display signal output to source output	100	ms
T5	Source/ Gate blanking time	30	ms
T6	Source/ Gate automatic output VSS	80	ms
T1'	DISP= "High" to AVDD/GVDD voltage stable time	20	ms
T2'	DISP= "High" to VGH/VGL/AVCL/GVCL voltage stable time	60	ms

Power OFF Sequence

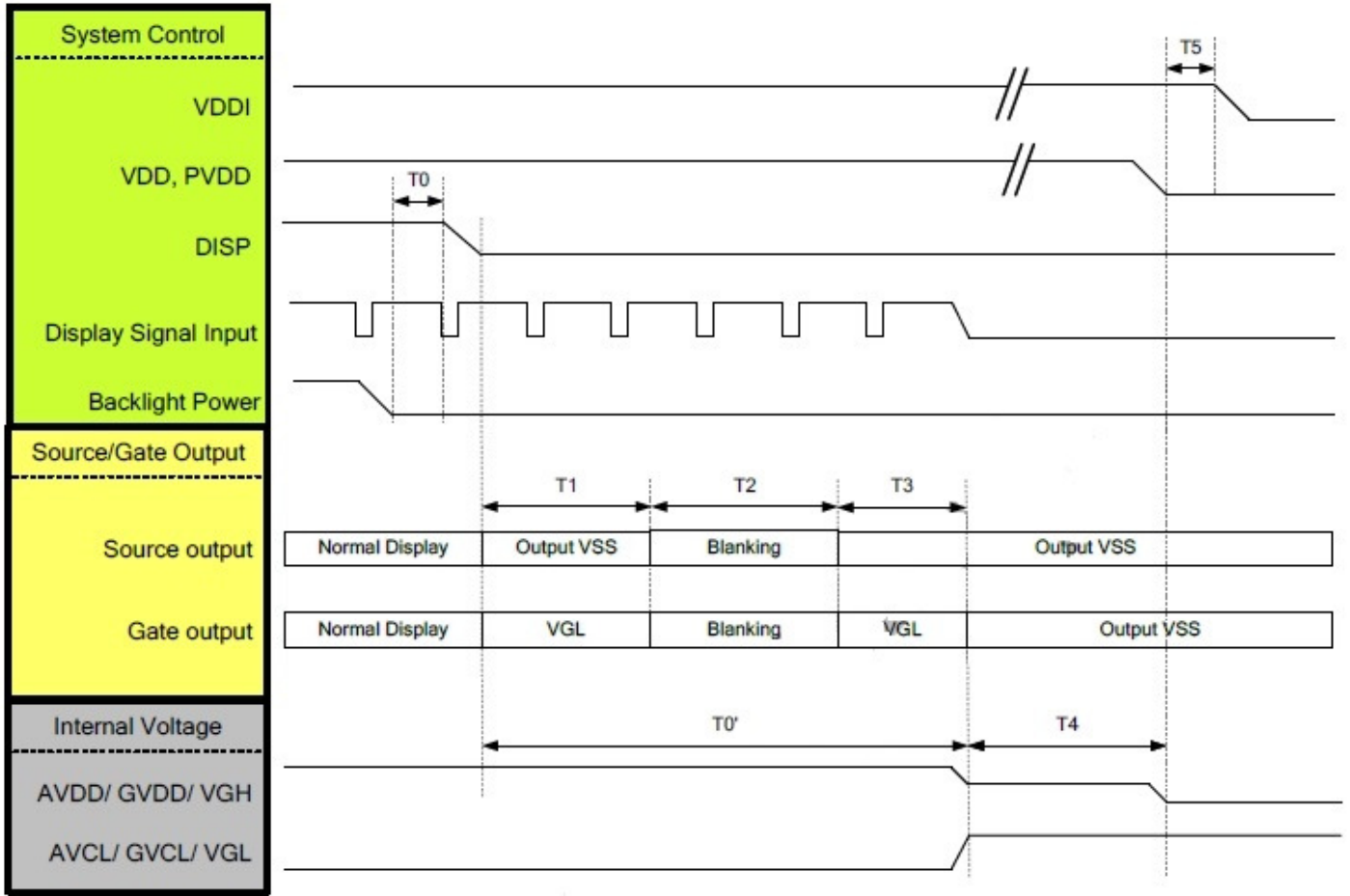

Symbol	Description	Min. Time	Unit
T0	Backlight power off to DISP off	5	ms
T1	Source voltage output VSS and Gate voltage output VGL	30	ms
T2	Source/ Gate blanking time	30	ms
T3	Source voltage output VSS and Gate voltage output VGL	20	ms
T4	AVDD/ GVDD/ VGH discharge time	5	ms
T5	Analog power off to digital power off time	0	ms
T0'	Source and Gate voltage discharge complete width	80	ms

3. QUALITY ASSURANCE SYSTEM

3.1 Quality Assurance Flow Chart

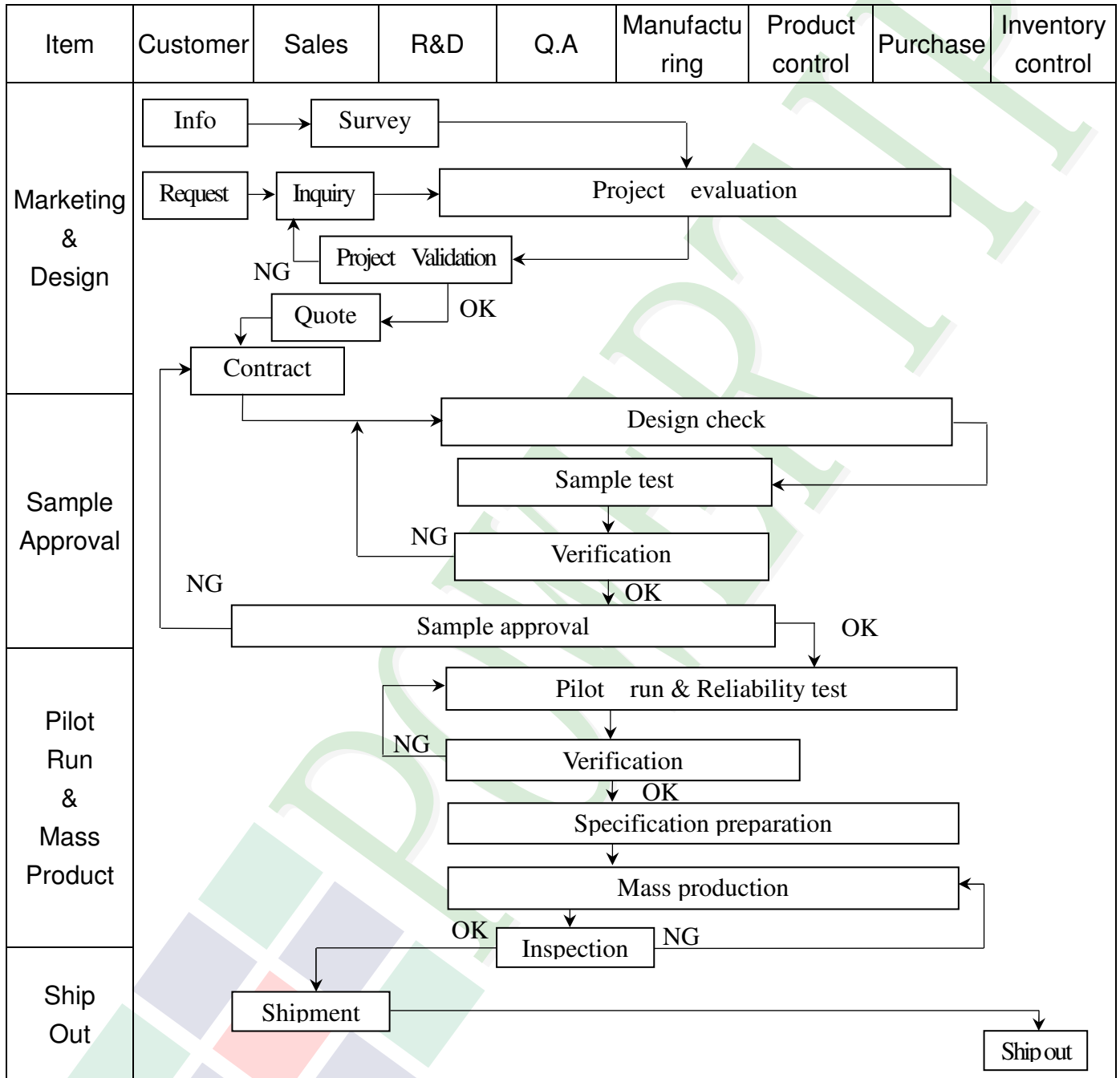

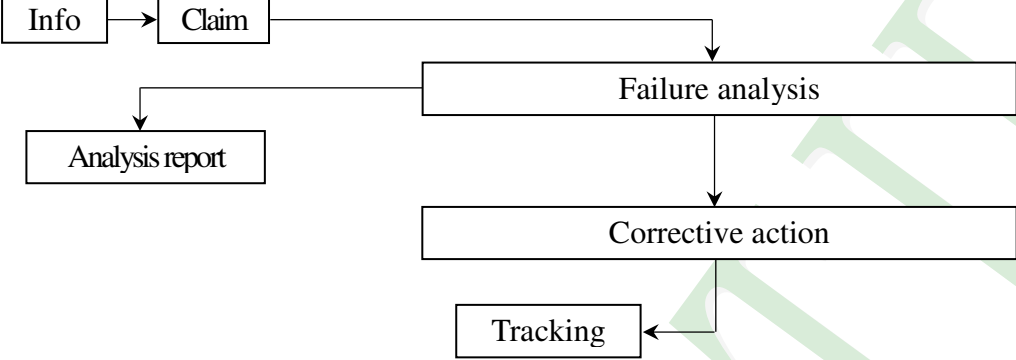
Item	Customer	Sales	R&D	Q.A	Manufacturing	Product control	Purchase	Inventory control
Sales Service	 <pre> graph TD Info[Info] --> Claim[Claim] Claim --> Failure[Failure analysis] Claim --> Report[Analysis report] Failure --> Action[Corrective action] Action --> Tracking[Tracking] </pre>							
Q.A Activity	1. ISO 9001 Maintenance Activities 3. Equipment calibration 5. Standardization Management				2. Process improvement proposal 4. Education And Training Activities			

3.2. Inspection Specification

◆Scope : The document shall be applied to TFT-LCD Module for 3.5" ~15" (Ver.B01).

◆Inspection Standard : MIL-STD-105E Table Normal Inspection Single Sampling Level II.

◆Equipment : Gauge 、 MIL-STD 、 Powertip Tester 、 Sample

◆Defect Level : Major Defect AQL : 0.4 ; Minor Defect AQL : 1.5

◆OUT Going Defect Level : Sampling.

◆Standard of the product appearance test :

a. Manner of appearance test :

(1). The test best be under 20W×2 fluorescent light , and distance of view must be at 30 cm.

(2). The test direction is base on about around 45° of vertical line.

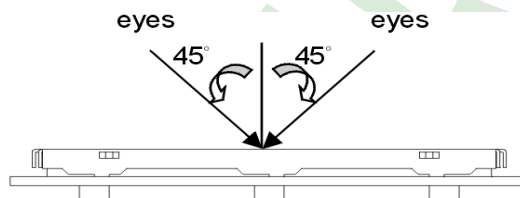

(3). Definition of area.

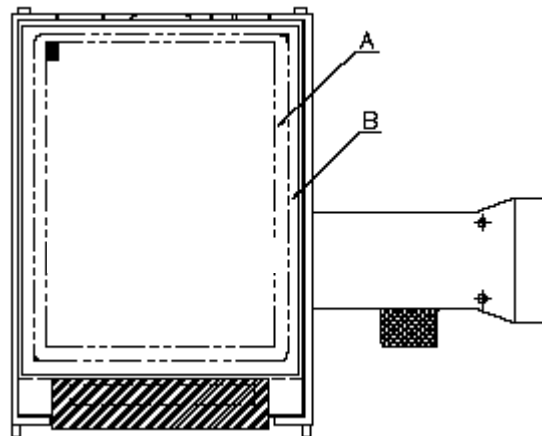

A area : viewing area

B area : Outside of viewing area

(4). Standard of inspection : (Unit : mm)

◆Specification For TFT-LCD Module 3.5" ~15" :
(Ver.B01)

NO	Item	Criterion	Level												
01	Product condition	1. 1 The part number is inconsistent with work order of production.	Major												
		1. 2 Mixed product types.	Major												
		1. 3 Assembled in inverse direction.	Major												
02	Quantity	2. 1 The quantity is inconsistent with work order of production.	Major												
03	Outline dimension	3. 1 Product dimension and structure must conform to structure diagram.	Major												
04	Electrical Testing	4. 1 Missing line character and icon.	Major												
		4. 2 No function or no display.	Major												
		4. 3 Display malfunction.	Major												
		4. 4 LCD viewing angle defect.	Major												
		4. 5 Current consumption exceeds product specifications.	Major												
		4. 6 Mura can not be seen through 5% ND filter. (Mura : Under the normal examination angle of view, the picture has the non-uniform phenomenon.)	Minor												
05	Dot defect (Bright dot 、 Dark dot) On -display	<table border="1" style="margin-left: auto; margin-right: auto;"> <thead> <tr> <th colspan="2">Item</th> <th>Acceptance (Q'ty)</th> </tr> </thead> <tbody> <tr> <td rowspan="4" style="text-align: center; vertical-align: middle;">Dot Defect</td> <td style="text-align: center;">Bright Dot</td> <td style="text-align: center;">≤ 4</td> </tr> <tr> <td style="text-align: center;">Dark Dot</td> <td style="text-align: center;">≤ 5</td> </tr> <tr> <td style="text-align: center;">Joint Dot</td> <td style="text-align: center;">≤ 3</td> </tr> <tr> <td style="text-align: center;">Total</td> <td style="text-align: center;">≤ 7</td> </tr> </tbody> </table>	Item		Acceptance (Q'ty)	Dot Defect	Bright Dot	≤ 4	Dark Dot	≤ 5	Joint Dot	≤ 3	Total	≤ 7	Minor
		Item		Acceptance (Q'ty)											
		Dot Defect	Bright Dot	≤ 4											
			Dark Dot	≤ 5											
			Joint Dot	≤ 3											
Total	≤ 7														
5. 1 Inspection pattern : full white , full black , Red , Green and blue screens.															
5. 2 It is defined as dot defect if defect area $> 1/2$ dot.															
5. 3 The distance between two dot defect ≥ 5 mm.															
5. 4 Bright dot that can not be seen through 5% ND filter.															

◆Specification For TFT-LCD Module 3.5" ~15" :

(Ver.B01)

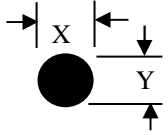
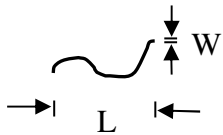
NO	Item	Criterion	Level																																												
06	Black or white dot、scratch、contamination Round type  $\Phi = (x + y) / 2$ Line type 	6.1 Round type (Non-display or display) : <table border="1"> <thead> <tr> <th rowspan="2">Dimension (diameter : Φ)</th> <th colspan="2">Acceptance (Q'ty)</th> </tr> <tr> <th>A area</th> <th>B area</th> </tr> </thead> <tbody> <tr> <td>$\Phi \leq 0.25$</td> <td colspan="2">Ignore</td> </tr> <tr> <td>$0.25 < \Phi \leq 0.50$</td> <td>5</td> <td rowspan="3">Ignore</td> </tr> <tr> <td>$\Phi > 0.50$</td> <td>0</td> </tr> <tr> <td>Total</td> <td>5</td> </tr> </tbody> </table>	Dimension (diameter : Φ)	Acceptance (Q'ty)		A area	B area	$\Phi \leq 0.25$	Ignore		$0.25 < \Phi \leq 0.50$	5	Ignore	$\Phi > 0.50$	0	Total	5	Minor																													
		Dimension (diameter : Φ)		Acceptance (Q'ty)																																											
A area	B area																																														
$\Phi \leq 0.25$	Ignore																																														
$0.25 < \Phi \leq 0.50$	5	Ignore																																													
$\Phi > 0.50$	0																																														
Total	5																																														
6.2 Line type(Non-display or display) : <table border="1"> <thead> <tr> <th rowspan="2">module size</th> <th rowspan="2">Length (L)</th> <th rowspan="2">Width (W)</th> <th colspan="2">Acceptance (Q'ty)</th> </tr> <tr> <th>A area</th> <th>B area</th> </tr> </thead> <tbody> <tr> <td rowspan="4">3.5" to less 9"</td> <td>---</td> <td>$W \leq 0.03$</td> <td colspan="2">Ignore</td> </tr> <tr> <td>$L \leq 10.0$</td> <td>$0.03 < W \leq 0.05$</td> <td>4</td> <td rowspan="3">Ignore</td> </tr> <tr> <td>$L \leq 5.0$</td> <td>$0.05 < W \leq 0.10$</td> <td>2</td> </tr> <tr> <td>---</td> <td>$W > 0.10$</td> <td colspan="2">As round type</td> </tr> <tr> <td colspan="3">Total</td> <td colspan="2">5</td> </tr> <tr> <td rowspan="4">9" to 15"</td> <td>---</td> <td>$W \leq 0.05$</td> <td colspan="2">Ignore</td> </tr> <tr> <td>$L \leq 10.0$</td> <td>$0.05 < W \leq 0.10$</td> <td>5</td> <td rowspan="3">Ignore</td> </tr> <tr> <td>---</td> <td>$W > 0.10$</td> <td colspan="2">As round type</td> </tr> <tr> <td colspan="3">Total</td> <td colspan="2">5</td> </tr> </tbody> </table>	module size	Length (L)	Width (W)	Acceptance (Q'ty)		A area	B area	3.5" to less 9"	---	$W \leq 0.03$	Ignore		$L \leq 10.0$	$0.03 < W \leq 0.05$	4	Ignore	$L \leq 5.0$	$0.05 < W \leq 0.10$	2	---	$W > 0.10$	As round type		Total			5		9" to 15"	---	$W \leq 0.05$	Ignore		$L \leq 10.0$	$0.05 < W \leq 0.10$	5	Ignore	---	$W > 0.10$	As round type		Total			5		
module size				Length (L)	Width (W)	Acceptance (Q'ty)																																									
	A area	B area																																													
3.5" to less 9"	---	$W \leq 0.03$	Ignore																																												
	$L \leq 10.0$	$0.03 < W \leq 0.05$	4	Ignore																																											
	$L \leq 5.0$	$0.05 < W \leq 0.10$	2																																												
	---	$W > 0.10$	As round type																																												
Total			5																																												
9" to 15"	---	$W \leq 0.05$	Ignore																																												
	$L \leq 10.0$	$0.05 < W \leq 0.10$	5	Ignore																																											
	---	$W > 0.10$	As round type																																												
	Total				5																																										
07	Polarizer Bubble	<table border="1"> <thead> <tr> <th rowspan="2">Dimension (diameter : Φ)</th> <th colspan="2">Acceptance (Q'ty)</th> </tr> <tr> <th>A area</th> <th>B area</th> </tr> </thead> <tbody> <tr> <td>$\Phi \leq 0.25$</td> <td colspan="2">Ignore</td> </tr> <tr> <td>$0.25 < \Phi \leq 0.50$</td> <td>4</td> <td rowspan="3">Ignore</td> </tr> <tr> <td>$0.50 < \Phi \leq 0.80$</td> <td>1</td> </tr> <tr> <td>$\Phi > 0.80$</td> <td>0</td> </tr> <tr> <td>Total</td> <td>5</td> <td></td> </tr> </tbody> </table>	Dimension (diameter : Φ)	Acceptance (Q'ty)		A area	B area	$\Phi \leq 0.25$	Ignore		$0.25 < \Phi \leq 0.50$	4	Ignore	$0.50 < \Phi \leq 0.80$	1	$\Phi > 0.80$	0	Total	5		Minor																										
Dimension (diameter : Φ)	Acceptance (Q'ty)																																														
	A area	B area																																													
$\Phi \leq 0.25$	Ignore																																														
$0.25 < \Phi \leq 0.50$	4	Ignore																																													
$0.50 < \Phi \leq 0.80$	1																																														
$\Phi > 0.80$	0																																														
Total	5																																														

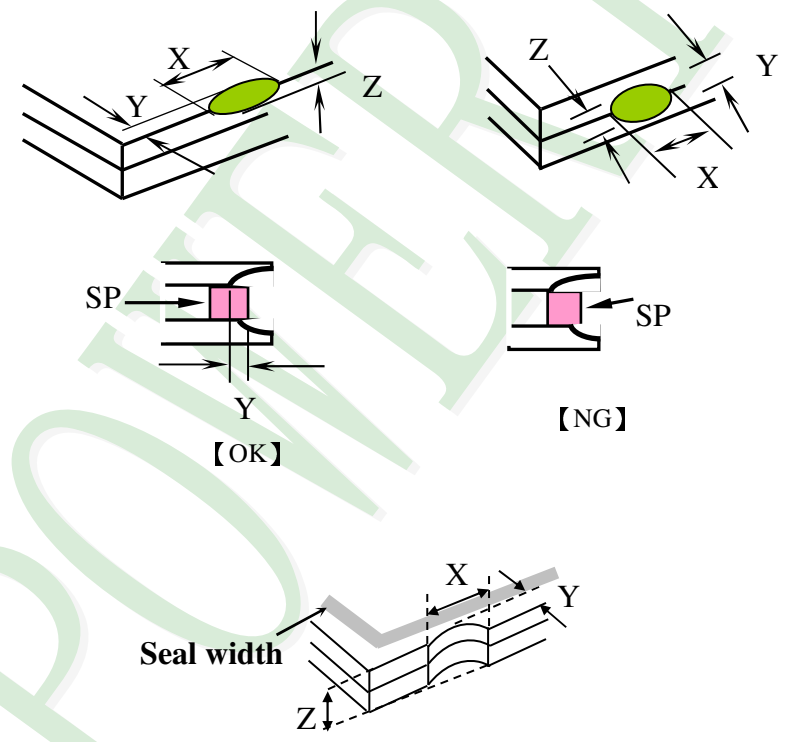
NO	Item	Criterion	Level									
08	The crack of glass	<p>Symbols :</p> <p>X : The length of crack Z : The thickness of crack t : The thickness of glass</p> <p>Y : The width of crack. W : terminal length a : LCD side length</p> <hr/> <p>8.1 General glass chip : 8.1.1 Chip on panel surface and crack between panels:</p>  <table border="1" data-bbox="539 1579 1353 1870"> <thead> <tr> <th>X</th> <th>Y</th> <th>Z</th> </tr> </thead> <tbody> <tr> <td>$\leq a$</td> <td>Crack can't enter viewing area</td> <td>$\leq 1/2 t$</td> </tr> <tr> <td>$\leq a$</td> <td>Crack can't exceed the half of SP width.</td> <td>$1/2 t < Z \leq 2 t$</td> </tr> </tbody> </table>	X	Y	Z	$\leq a$	Crack can't enter viewing area	$\leq 1/2 t$	$\leq a$	Crack can't exceed the half of SP width.	$1/2 t < Z \leq 2 t$	Minor
X	Y	Z										
$\leq a$	Crack can't enter viewing area	$\leq 1/2 t$										
$\leq a$	Crack can't exceed the half of SP width.	$1/2 t < Z \leq 2 t$										

◆ Specification For TFT-LCD Module 3.5" ~15" :

(Ver.B01)

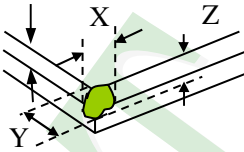
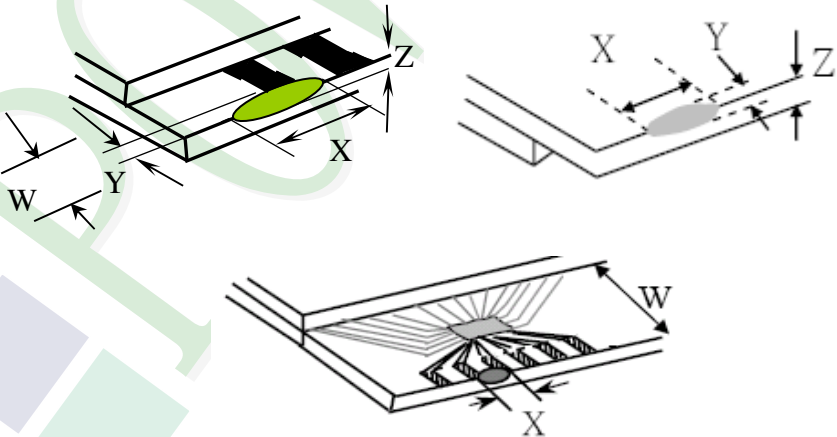
NO	Item	Criterion	Level												
08	The crack of glass	<p>Symbols :</p> <p>X : The length of crack Z : The thickness of crack t : The thickness of glass</p> <p>Y : The width of crack. W : terminal length a : LCD side length</p> <hr/> <p>8.1.2 Corner crack :</p>  <table border="1" data-bbox="520 768 1337 1059"> <thead> <tr> <th>X</th> <th>Y</th> <th>Z</th> </tr> </thead> <tbody> <tr> <td>$\leq 1/5 a$</td> <td>Crack can't enter viewing area</td> <td>$Z \leq 1/2 t$</td> </tr> <tr> <td>$\leq 1/5 a$</td> <td>Crack can't exceed the half of SP width.</td> <td>$1/2 t < Z \leq 2 t$</td> </tr> </tbody> </table>	X	Y	Z	$\leq 1/5 a$	Crack can't enter viewing area	$Z \leq 1/2 t$	$\leq 1/5 a$	Crack can't exceed the half of SP width.	$1/2 t < Z \leq 2 t$				
		X	Y	Z											
$\leq 1/5 a$	Crack can't enter viewing area	$Z \leq 1/2 t$													
$\leq 1/5 a$	Crack can't exceed the half of SP width.	$1/2 t < Z \leq 2 t$													
		<p>8.2 Protrusion over terminal :</p> <p>8.2.1 Chip on electrode pad :</p>  <table border="1" data-bbox="560 1697 1345 1872"> <thead> <tr> <th></th> <th>X</th> <th>Y</th> <th>Z</th> </tr> </thead> <tbody> <tr> <td>Front</td> <td>$\leq a$</td> <td>$\leq 1/2 W$</td> <td>$\leq t$</td> </tr> <tr> <td>Back</td> <td>$\leq a$</td> <td>$\leq W$</td> <td>$\leq 1/2 t$</td> </tr> </tbody> </table>		X	Y	Z	Front	$\leq a$	$\leq 1/2 W$	$\leq t$	Back	$\leq a$	$\leq W$	$\leq 1/2 t$	Minor
	X	Y	Z												
Front	$\leq a$	$\leq 1/2 W$	$\leq t$												
Back	$\leq a$	$\leq W$	$\leq 1/2 t$												

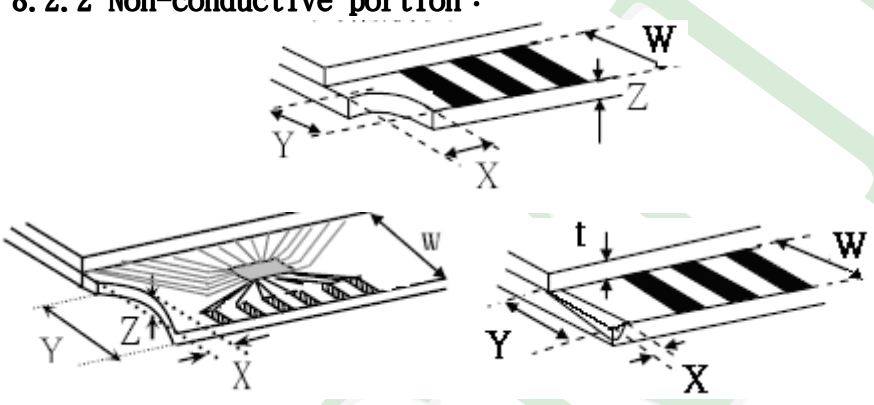
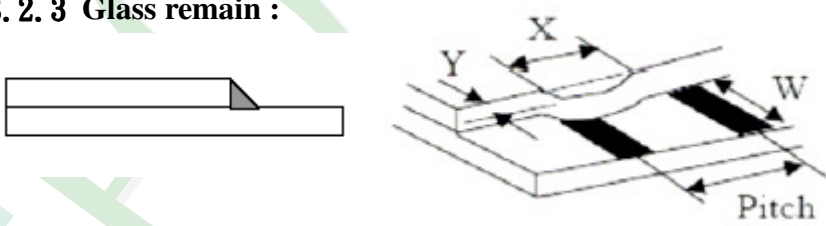
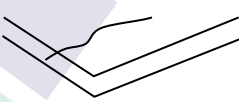
NO	Item	Criterion	Level												
08	The crack of glass	<p>Symbols :</p> <p>X : The length of crack Y : The width of crack. Z : The thickness of crack W : terminal length t : The thickness of glass a : LCD side length</p> <hr/> <p>8.2.2 Non-conductive portion :</p>  <table border="1" data-bbox="625 967 1257 1093"> <thead> <tr> <th>X</th> <th>Y</th> <th>Z</th> </tr> </thead> <tbody> <tr> <td>$\leq 1/3 a$</td> <td>$\leq W$</td> <td>$\leq t$</td> </tr> </tbody> </table> <p>⊙ If the chipped area touches the ITO terminal, over 2/3 of</p> <ul style="list-style-type: none"> ● the ITO must remain and be inspected according to electrode terminal specifications. <p>8.2.3 Glass remain :</p>  <table border="1" data-bbox="545 1523 1241 1648"> <thead> <tr> <th>X</th> <th>Y</th> <th>Z</th> </tr> </thead> <tbody> <tr> <td>$\leq a$</td> <td>$\leq 1/3 W$</td> <td>$\leq t$</td> </tr> </tbody> </table> <p>8.2.4 Cracking</p>  <p style="text-align: center;">Not Allowed</p>	X	Y	Z	$\leq 1/3 a$	$\leq W$	$\leq t$	X	Y	Z	$\leq a$	$\leq 1/3 W$	$\leq t$	Minor
X	Y	Z													
$\leq 1/3 a$	$\leq W$	$\leq t$													
X	Y	Z													
$\leq a$	$\leq 1/3 W$	$\leq t$													

◆Specification For TFT-LCD Module 3.5" ~15" :
(Ver.B01)

NO	Item	Criterion	Level
09	Backlight elements	9. 1 Backlight can't work normally.	Major
		9. 2 Backlight doesn't light or color is wrong.	Major
		9. 3 Illumination source flickers when lit.	Major
10	General appearance	10. 1 Pin type 、 quantity 、 dimension must match type in structure diagram.	Major
		10. 2 No short circuits in components on PCB or FPC .	Major
		10. 3 Parts on PCB or FPC must be the same as on the production characteristic chart .There should be no wrong parts , missing parts or excess parts.	Major
		10. 4 Product packaging must the same as specified on packaging specification sheet.	Minor
		10. 5 The folding and peeled off in polarizer are not acceptable.	Minor
		10. 6 The PCB or FPC between B/L assembled distance(PCB or FPC) is ≤ 1.5 mm.	Minor

4. RELIABILITY TEST

4.1 Reliability Test Condition

(Ver.B01)

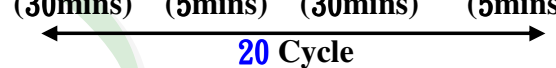
NO.	TEST ITEM	TEST CONDITION										
1	High Temperature Storage Test	Keep in +85 ±2°C 240 hrs Surrounding temperature, then storage at normal condition 4hrs.										
2	Low Temperature Storage Test	Keep in -40 ±2°C 240 hrs Surrounding temperature, then storage at normal condition 4hrs.										
3	High Temperature / High Humidity Storage Test	Keep in +60°C / 90% R.H duration for 240 hrs Surrounding temperature, then storage at normal condition 4hrs. (Excluding the polarizer)										
4	ESD Test	Air Discharge: (include mobile phone) Apply 2 KV with 5 times Discharge for each polarity +/-	Contact Discharge: (include mobile phone) Apply 250V with 5 times discharge for each polarity +/-									
		<ol style="list-style-type: none"> Temperature ambience: 15°C ~ 35°C Humidity relative: 30% ~ 60% Energy Storage Capacitance(Cs+Cd): 150pF±10% Discharge Resistance(Rd): 330Ω±10% Discharge, mode of operation: Single Discharge (time between successive discharges at least 1 s) (Tolerance if the output voltage indication: ±5%) 										
5	Temperature Cycling Storage Test	<p style="text-align: center;"> -40°C → +25°C → +85°C → +25°C (30mins) (5mins) (30mins) (5mins)  </p> Surrounding temperature, then storage at normal condition 4hrs.										
6	Vibration Test (Packaged)	<ol style="list-style-type: none"> Sine wave 10~55 Hz frequency (1 min) The amplitude of vibration : 1.5 mm Each direction (X、Y、Z) duration for 2 Hrs 										
7	Drop Test (Packaged)	<table border="1" style="margin-left: auto; margin-right: auto;"> <thead> <tr> <th>Packing Weight (Kg)</th> <th>Drop Height (cm)</th> </tr> </thead> <tbody> <tr> <td>0 ~ 45.4</td> <td>122</td> </tr> <tr> <td>45.4 ~ 90.8</td> <td>76</td> </tr> <tr> <td>90.8 ~ 454</td> <td>61</td> </tr> <tr> <td>Over 454</td> <td>46</td> </tr> </tbody> </table> <p style="text-align: center;">Drop direction : ※ 1 corner / 3 edges / 6 sides each 1times</p>	Packing Weight (Kg)	Drop Height (cm)	0 ~ 45.4	122	45.4 ~ 90.8	76	90.8 ~ 454	61	Over 454	46
Packing Weight (Kg)	Drop Height (cm)											
0 ~ 45.4	122											
45.4 ~ 90.8	76											
90.8 ~ 454	61											
Over 454	46											

5. PRECAUTION RELATING PRODUCT HANDLING

5.1 SAFETY

- 5.1.1 If the LCD panel breaks , be careful not to get the liquid crystal to touch your skin.
- 5.1.2 If the liquid crystal touches your skin or clothes , please wash it off immediately by using soap and water.

5.2 HANDLING

- 5.2.1 Avoid any strong mechanical shock which can break the glass.
- 5.2.2 Avoid static electricity which can damage the CMOS LSI—When working with the module , be sure to ground your body and any electrical equipment you may be using.
- 5.2.3 Do not remove the panel or frame from the module.
- 5.2.4 The polarizing plate of the display is very fragile. So , please handle it very carefully ,do not touch , push or rub the exposed polarizing with anything harder than an HB pencil lead (glass , tweezers , etc.)
- 5.2.5 Do not wipe the polarizing plate with a dry cloth , as it may easily scratch the surface of plate.
- 5.2.6 Do not touch the display area with bare hands , this will stain the display area.
- 5.2.7 Do not use ketonics solvent & aromatic solvent. Use with a soft cloth soaked with a cleaning naphtha solvent.
- 5.2.8 To control temperature and time of soldering is $320\pm 10^{\circ}\text{C}$ and 3-5 sec.
- 5.2.9 To avoid liquid (include organic solvent) stained on LCM .

5.3 STORAGE

- 5.3.1 Store the panel or module in a dark place where the temperature is $25^{\circ}\text{C} \pm 5^{\circ}\text{C}$ and the humidity is below 65% RH.
- 5.3.2 Do not place the module near organics solvents or corrosive gases.
- 5.3.3 Do not crush , shake , or jolt the module.

5.4 TERMS OF WARRANTY

- 5.4.1 Applicable warrant period
The period is within thirteen months since the date of shipping out under normal using and storage conditions.
- 5.4.2 Unaccepted responsibility
This product has been manufactured to your company's specification as a part for use in your company's general electronic products. It is guaranteed to perform according to delivery specifications. For any other use apart from general electronic equipment , we cannot take responsibility if the product is used in nuclear power control equipment , aerospace equipment , fire and security systems or any other applications in which there is a direct risk to human life and where extremely high levels of reliability are required.

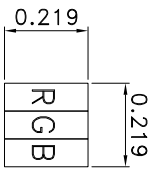
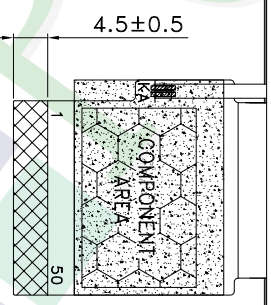
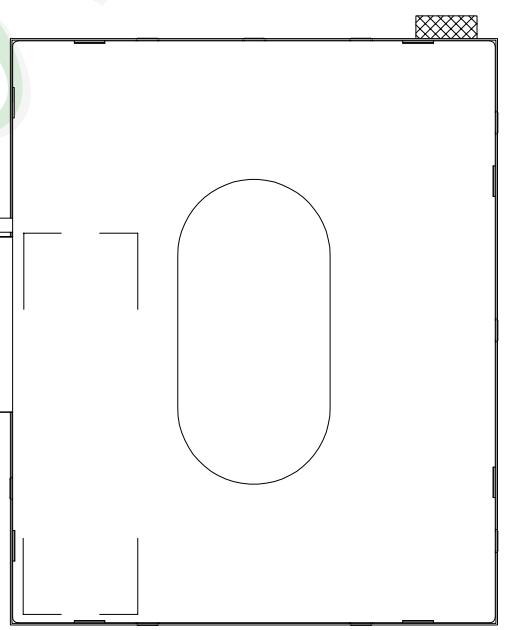
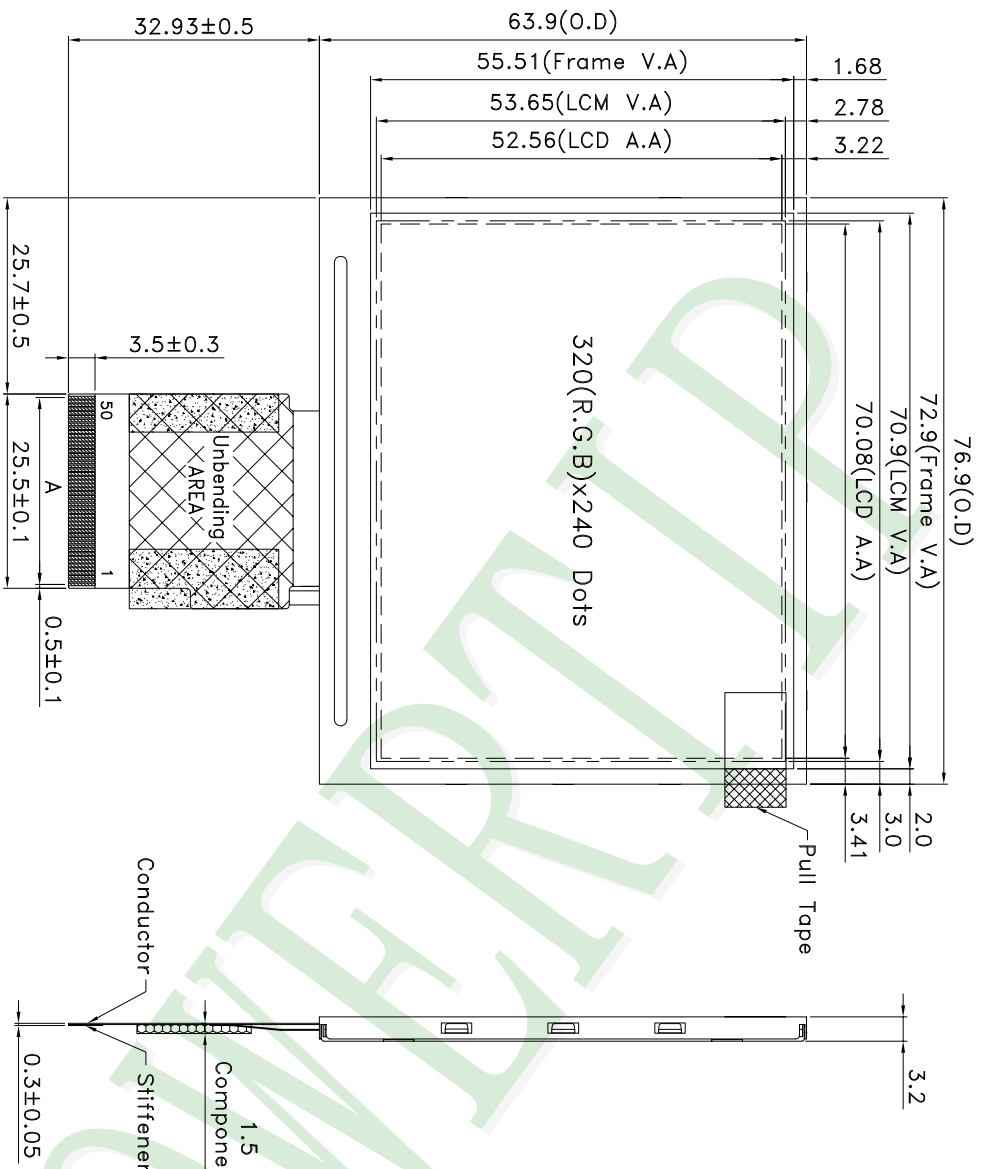

Detail Dots
Scale 50X

- NOTES:
- 1.LCD TYPE: TFT
 - 2.LCD DISPLAY:Normally Black/TRANSMISSIVE
 - 3.A=0.5X49=24.5±0.05 ; W=0.35±0.05
 - 4.The tolerance unless classified ±0.3mm
 - 5.FPC Connector : HIROSE FH12A-50S-0.5H OR EQUIVALENT
 6. Shielding tape

007			
006			
005			
004			
003			
002			
001	NEW DRAWING	Clare	2018/09/17
REV	REV BY	REVISER	DATE

PART NO:	PH320240T028-ZEA01
DRAWING NAME:	LMD-PH320240T028-ZEA01
TITLE:	LCD MODULE DRAWING

Design	Clare	Unit	MM	Surface	
Check	Tina	Scale	FIT	Material	
Approve	Jimmy	Page	1/2	Thickness	
		Quantity			

久正光電股份有限公司
POWER TIP TECHNOLOGY CORPORATION

7	Resolution (mm)	Precision Level
1	~ 4	-
4	~ 16	-
16	~ 63	-
63	~ 250	-
250	~ 1000	-

Ver.001

Documents NO. PKG-PH320240T028-ZEA01

LCM包裝規格書

LCM Packaging Specifications

(For Tray)

Approve	Check	Contact
Jimmy	Tina	Clare

1. 包裝材料規格表 (Packaging Material) : (per carton)

No.	Item	Model	Dimensions (mm)	1Pcs Weight	Quantity	Total Weight
1	成品 (LCM)	PH320240T028-ZEA01	76.9 X 63.9X3.2	0.028	288	8.064
2	多層薄膜(1)POF	OTFILM0BA03ABA	19"X350X0.015	—	6	—
3	TRAY 盤 (2)Tray	TYSG000000014	352 X 260 X 10.8	0.1	54	5.4
4	內盒(3)Product Box	BX36627063ABBA	383 X 270 X 66	0.182	6	1.092
5	保利龍板(4)Polylon board	OTPLB00PL08ABA	550 X 393 X 20	0.0284	2	0.0568
6	外紙箱(5)Carton	BX57041027CCBA	570 X 410 X 265	1.0	1	1.0
7						
8						
9						

2. 一整箱總重量 (Total LCD Weight in carton) : 15.61 Kg±10%

3. 單箱數量規格表 (Packaging Specifications and Quantity) :

(1) LCM quantity per box : no per tray	6	x no of tray	8	=	48
(2) Total LCM quantity in carton : quantity per box	48	x no of boxes	6	=	288

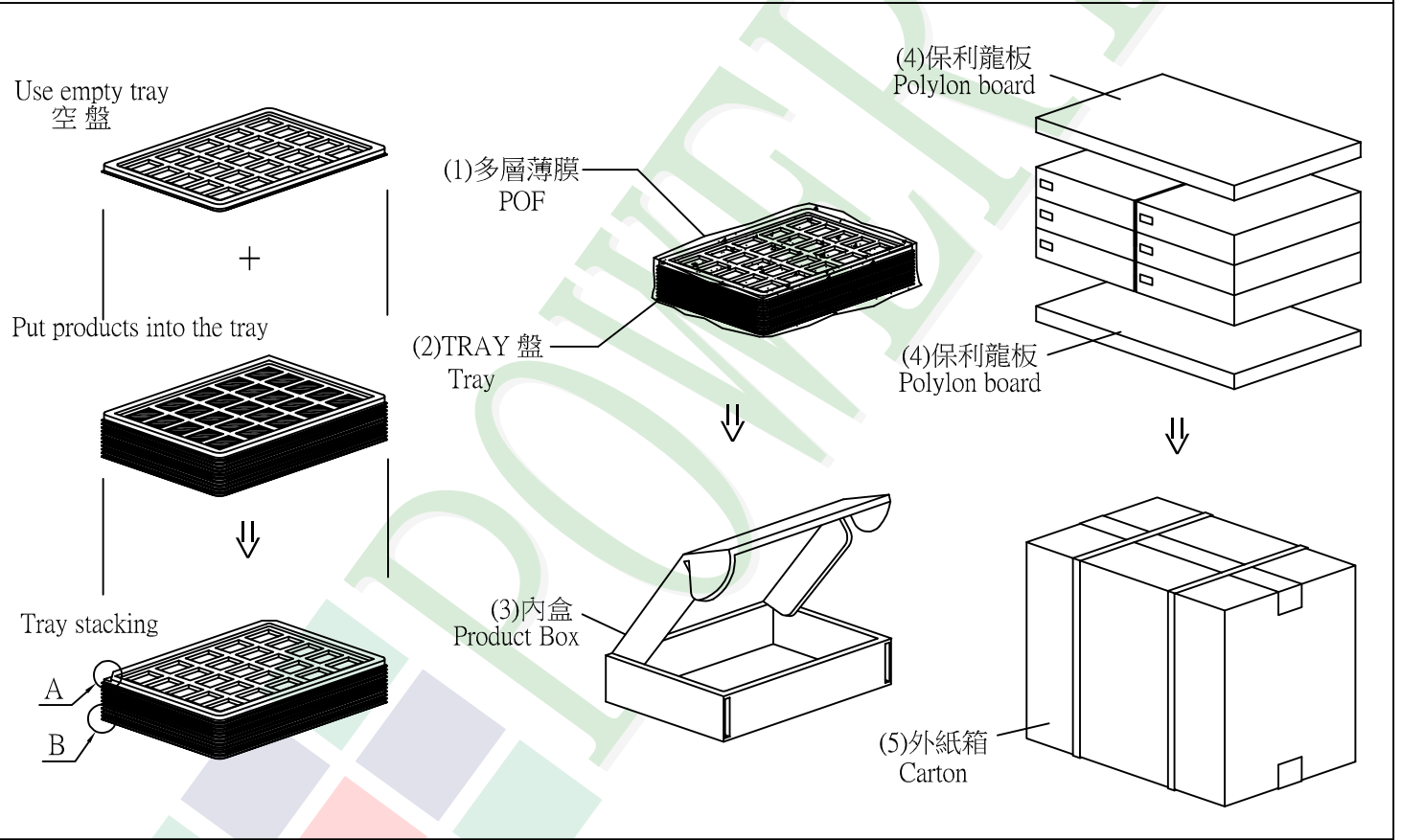

特 記 事 項 (REMARK)

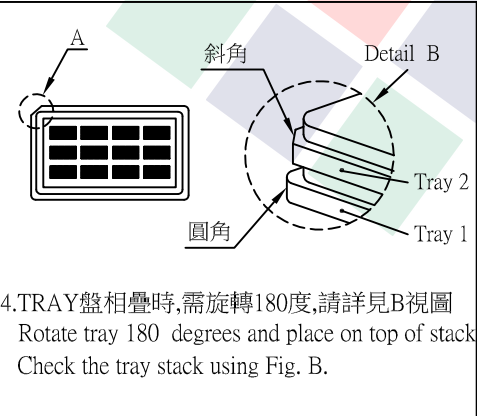

4. TRAY盤相疊時,需旋轉180度,請詳見B視圖
 Rotate tray 180 degrees and place on top of stack.
 Check the tray stack using Fig. B.