

■ **Features**

- High Luminous LEDs
- 5mm Round Standard Directivity
- UV Resistant Epoxy
- Water Clear / White Diffused

■ **Applications**

- Back Lighting
- Small Area Illuminations
- General Lighting

■ **Outline Dimension**

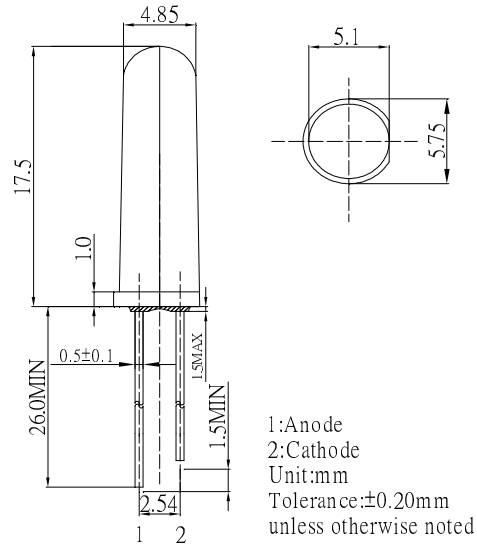

■ **Absolute Maximum Rating (Ta=25°C)**

Item	Symbol	Value		Unit
		W/M/K/BL/PG	Y/O/R	
DC Forward Current	I _F	30	30	mA
Pulse Forward Current#	I _{FP}	100	100	mA
Reverse Voltage	V _R	5	5	V
Power Dissipation	P _D	102	78	mW
Operating Temperature	T _{opr}	-30 ~ +85		°C
Storage Temperature	T _{stg}	-40 ~ +100		°C
Lead Soldering Temperature	T _{sol}	260°C/5sec		-

■ **Directivity**

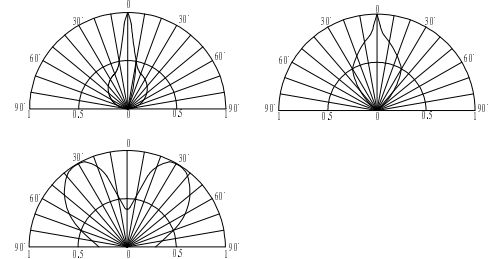

#Pulse width Max.10ms Duty ratio max 1/10

■ **Electrical -Optical Characteristics (Ta=25°C)**











Part Number	Color		V _F (V)*			I _R (μA)	I _v (mcd)*			CCT(K)*			2θ1/2(deg)
			Min.	Typ.	Max.		Max.	Min.	Typ.	Max.	Min.	Typ.	
			I _F =20mA			V _R =5V		I _F =20mA					
OSW5DK6E61A	Cool White	W	2.7	2.9	3.4	10	2180	3000	-	8500-18000K(X:0.27,Y:0.28)			60
OSM5DK6E61A	Warm White	M	2.7	2.9	3.4	10	2180	3000	-	2700-3300K(X:0.44,Y:0.41)			60
OSK5DK6E61A	Pink	K	2.7	2.9	3.4	10	750	1120	-	X:0.45,Y:0.17			60
OSW5DK6EE2A	Cool White	W	2.7	2.9	3.4	10	500	750	-	8500-18000K(X:0.27,Y:0.28)			140
OSM5DK6EE2A	Warm White	M	2.7	2.9	3.4	10	500	750	-	2700-3300K(X:0.44,Y:0.41)			140
OSK5DK6EE2A	Pink	K	2.7	2.9	3.4	10	150	220	-	X:0.45,Y:0.17			140

*1 Tolerance of measurements of chromaticity coordinate is ±10%

*2 Tolerance of measurements of luminous intensity is ±15%

*3 Tolerance of measurements of forward voltage is ±0.1V

■ **Electrical -Optical Characteristics** (Ta=25°C)

Part Number	Color			V _F (V)*			I _R (μA)	I _v (mcd)*			Wd(nm)*			2θ1/2(deg)
				Min.	Typ.	Max.	Max.	Min.	Typ.	Max.	Min.	Typ.	Max.	Typ.
				I _F =20mA			V _R =5V	I _F =20mA						
OSB5SA6E21A	Blue	BL		2.7	3.0	3.4	10	1120	1560	-	465	470	475	20
OSG5DA6E21A	Pure Green	PG		2.7	3.0	3.4	10	4200	5800	-	520	525	530	20
OSY5PA6E21A	Yellow	Y		1.8	2.1	2.6	10	1560	2180	-	585	590	595	20
OSO5PA6E21A	Orange	O		1.8	2.1	2.6	10	1560	2180	-	600	605	610	20
OSR5PA6E21A	Red	R		1.8	2.1	2.6	10	1560	2180	-	620	625	630	20
OSB5SA6EE2A	Blue	BL		2.7	3.0	3.4	10	100	150	-	465	470	475	140
OSG5DA6EE2A	Pure Green	PG		2.7	3.0	3.4	10	330	500	-	520	525	530	140
OSY5PA6EE2A	Yellow	Y		1.8	2.1	2.6	10	150	220	-	585	590	595	140
OSO5PA6EE2A	Orange	O		1.8	2.1	2.6	10	150	220	-	600	605	610	140
OSR5PA6EE2A	Red	R		1.8	2.1	2.6	10	150	220	-	620	625	630	140

*1 Tolerance of measurements of dominant wavelength is ±1nm

*2 Tolerance of measurements of luminous intensity is ±15%

*3 Tolerance of measurements of forward voltage is ±0.1V