



■ Features

- Plastic housing with class II and PFC design
- Constant Voltage + Constant current mode output
- Standby power consumption <0.5W
- IP67 rating for indoor or outdoor installations
- Dimming function: 3 in 1 Dimming(C.V Dim. only) to adjust output voltage level
- Flicker free Design
- Typical lifetime >50000hours
- 5 years warranty

■ Applications

- LED panel lighting
- LED downlight
- LED decorative lighting
- Industrial lighting
- Sign board and back light
- LED strip lighting(C.V Dimming)
- Agricultural lighting(C.V Dimming)
- Poultry lighting (C.V Dimming)
- Type “HL” for use in Class I, Division 2 hazardous (Classified) location

■ GTIN CODE

MW Search: <https://www.meanwell.com/serviceGTIN.aspx>

■ Description

NPF-200 series is a 200W AC/DC LED driver featuring the constant current or constant voltage mode output. NPF-200 operates from 100~305VAC and offers models with different rated voltage ranging between 12V and 54V. Thanks to the high efficiency up to 94% with the fanless design, the entire series is able to operate for -40℃~+85℃ case temperature under free air convection. The entire series is rated with IP67 ingress protection level and is suitable to work for a variety of applications at dry, damp or wet locations. NPF-200 is particular design without flicker Dimming Function which is suitable for LED strip or Poultry lighting applications.

■ Model Encoding

NPF - 200 **V** - 12

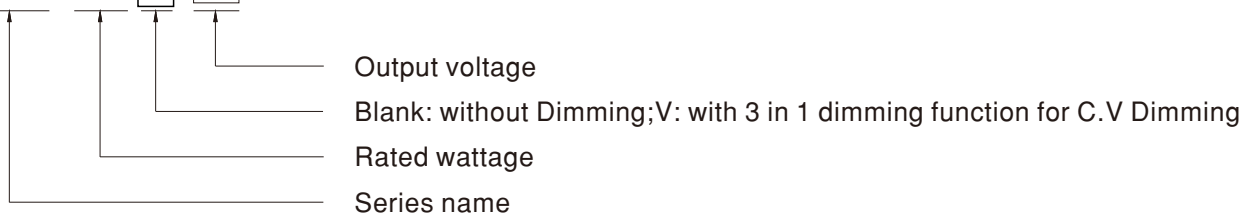

Type	IP Level	Function	Note
Blank	IP67	Constant Voltage + Constant current mode output	In Stock
V	IP67	3 in 1 dimming function to adjust output voltage (C.V Dimming)	In Stock

SPECIFICATION

MODEL		NPF-200□-12	NPF-200□-24	NPF-200□-36	NPF-200□-42	NPF-200□-48	NPF-200□-54	
OUTPUT	DC Voltage	12V	24V	36V	42V	48V	54V	
	CONSTANT CURRENT AND OUTPUT VOLTAGE REGION	6 ~ 12V	12~24V	18 ~ 36V	21 ~ 42V	24 ~ 48V	27 ~ 54V	
	RATED CURRENT	15A	8.3A	5.55A	4.75A	4.17A	3.71A	
	RATED POWER	180W	199.2W	199.8W	199.5W	200.1W	200.3W	
	RIPPLE & NOISE (max.) Note.9	150mVp-p	150mVp-p	200mVp-p	250mVp-p	250mVp-p	350mVp-p	
	VOLTAGE TOLERANCE Note.10	±4.0%	±4.0%	±2.0%	±2.0%	±2.0%	±2.0%	
	LINE REGULATION	±0.5%	±0.5%	±0.5%	±0.5%	±0.5%	±0.5%	
	LOAD REGULATION	±2.0%	±0.5%	±0.5%	±0.5%	±0.5%	±0.5%	
	CURRENT TOLERANCE	±5.0%						
	SET UP TIME Note.3	500ms/230VAC or 115VAC						
	RISE TIME	80ms for Blank type, 200ms for V-type						
HOLD UP TIME (Typ.)	10ms/230VAC or 115VAC							
INPUT	VOLTAGE RANGE Note.2	100 ~ 305VAC 142 ~ 431VDC (Please refer to "STATIC CHARACTERISTIC" section)						
	FREQUENCY RANGE	47 ~ 63Hz						
	POWER FACTOR (Typ.)	PF ≥ 0.97/115VAC, PF ≥ 0.96/230VAC, PF ≥ 0.94/277VAC@full load (Please refer to "POWER FACTOR (PF) CHARACTERISTIC" section)						
	TOTAL HARMONIC DISTORTION	THD < 20% (@load ≥ 60%/115VAC, 230VAC; @load ≥ 75%/277VAC) (Please refer to "TOTAL HARMONIC DISTORTION(THD)" section)						
	EFFICIENCY(Typ.)	92%	93%	94%	94%	94%	94%	
	AC CURRENT (Typ.)	2.2A / 115VAC	1.1A / 230VAC	0.9A / 277VAC				
	INRUSH CURRENT(Typ.)	COLD START 65A(twidth=550 μs measured at 50% Ipeak) at 230VAC; Per NEMA 410						
	MAX. NO. of PSUs on 16A CIRCUIT BREAKER	3 units (circuit breaker of type B) / 5 units (circuit breaker of type C) at 230VAC						
	LEAKAGE CURRENT	<0.25mA / 277VAC						
STANDBY POWER CONSUMPTION	<0.5W for V-type only (Output voltage dim to off)							
PROTECTION	OVER CURRENT	95 ~ 108% Hiccup mode or Constant current limiting, recovers automatically after fault condition is removed						
	SHORT CIRCUIT	Hiccup mode or Constant current limiting, recovers automatically after fault condition is removed						
	OVER VOLTAGE	13 ~ 18V	27 ~ 34V	41 ~ 49V	46 ~ 57V	53 ~ 65V	59 ~ 70V	
	OVER TEMPERATURE	Shut down o/p voltage, re-power on to recover						
ENVIRONMENT	WORKING TEMP.	Tcase=-40 ~ +85°C (Please refer to " OUTPUT LOAD vs TEMPERATURE" section)						
	MAX. CASE TEMP.	Tcase=+85°C						
	WORKING HUMIDITY	20 ~ 95% RH non-condensing						
	STORAGE TEMP., HUMIDITY	-40 ~ +80°C, 10 ~ 95% RH						
	TEMP. COEFFICIENT	±0.03%/°C (0 ~ 40°C)						
VIBRATION	10 ~ 500Hz, 5G 12min./1cycle, period for 72min. each along X, Y, Z axes							
SAFETY & EMC	SAFETY STANDARDS	UL8750(type"HL"), CSA C22.2 No. 250.13-12, According to BS EN/EN61347-2-13 appendix J suitable for emergency installations. ENEC BS EN/EN61347-1, BS EN/EN61347-2-13, BS EN/EN62384 independent, EAC TP TC 004, GB19510.1,GB19510.14,IP67 approved; Design refer to BS EN/EN60335-1						
	WITHSTAND VOLTAGE	I/P-O/P:3.75KVAC						
	ISOLATION RESISTANCE	I/P-O/P:100M Ohms / 500VDC / 25°C / 70% RH						
	EMC EMISSION	Compliance to BS EN/EN55015, BS EN/EN61000-3-2 Class C (@ load ≥ 60%); BS EN/EN61000-3-3;GB17743 and GB17625.1, EAC TP TC 020						
EMC IMMUNITY	Compliance to BS EN/EN61000-4-2,3,4,5,6,8,11; BS EN/EN61547, light industry level(surge immunity Line-Line 2KV); EAC TP TC 020							
OTHERS	MTBF	2625.4K hrs min. Telcordia SR-332 (Bellcore); 247.5K hrs min. MIL-HDBK-217F (25°C)						
	DIMENSION	195*68*39.5mm (L*W*H)						
	PACKING	1.03Kg; 12pcs/ 13.4Kg/ 0.71CUFT						
NOTE	<ol style="list-style-type: none"> All parameters NOT specially mentioned are measured at 230VAC input, rated current and 25°C of ambient temperature. De-rating may be needed under low input voltages. Please refer to "STATIC CHARACTERISTIC" sections for details. Length of set up time is measured at first cold start. Turning ON/OFF the driver may lead to increase of the set up time. The driver is considered as a component that will be operated in combination with final equipment. Since EMC performance will be affected by the complete installation, the final equipment manufacturers must re-qualify EMC Directive on the complete installation again. This series meets the typical life expectancy of >50,000 hours of operation when Tcase, particularly (⊙) point (or TMP, per DLC), is about 75°C or less. Please refer to the warranty statement on MEAN WELL's website at http://www.meanwell.com The ambient temperature derating of 3.5°C/1000m with fanless models and of 5°C/1000m with fan models for operating altitude higher than 2000m(6500ft). For any application note and IP water proof function installation caution, please refer our user manual before using. https://www.meanwell.com/Upload/PDF/LED_EN.pdf Ripple & noise are measured at 20MHz of bandwidth by using a 12" twisted pair-wire terminated with a 0.1uf & 47uf parallel capacitor. Tolerance : includes set up tolerance, line regulation and load regulation. To fulfill requirements of the latest ErP regulation for lighting fixtures, this LED power supply can only be used behind a switch without permanently connected to the mains. 							
	✕ Product Liability Disclaimer : For detailed information, please refer to https://www.meanwell.com/serviceDisclaimer.aspx							

■ BLOCK DIAGRAM

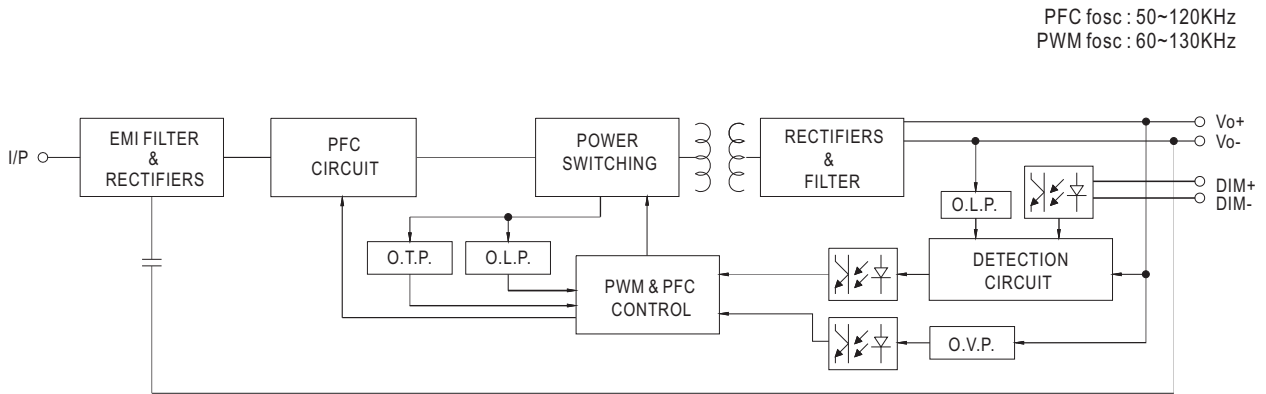

■ DRIVING METHODS OF LED MODULE

※ This series works in constant current mode to directly drive the LEDs.

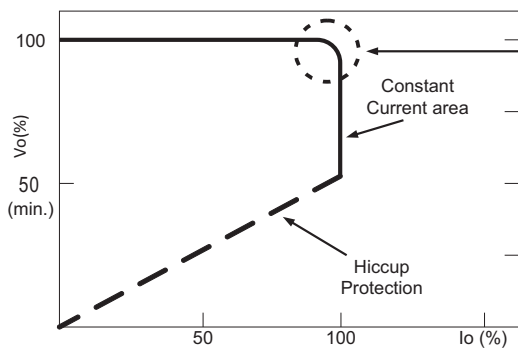

Typical LED power supply I-V curve

In the constant current region, the highest voltage at the output of the driver depends on the configuration of the end systems.

Should there be any compatibility issues, please contact MEAN WELL.

■ DIMMING OPERATION

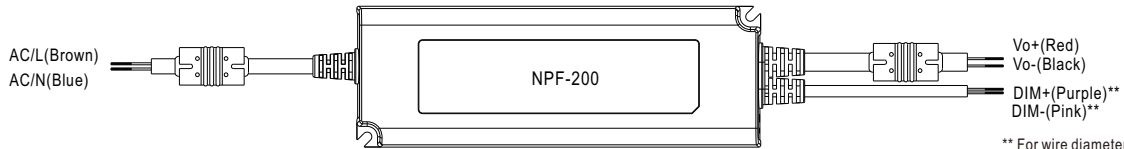

** For wire diameters, please refer to Mechanical Specification

※ **3 in 1 dimming function to adjust output voltage level**

- Output constant voltage can be adjusted by applying one of the three methodologies between DIM+ and DIM-: 0 ~ 10VDC, or 10V PWM signal or resistance.
- Direct connecting to LEDs is suggested. It is not suitable to be used with additional drivers.
- Dimming source current from power supply: 100μA (typ.)
- ◎ Applying additive 0 ~ 10VDC

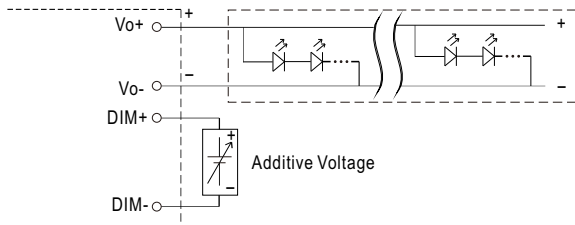

"DO NOT connect "DIM- to Vo-"

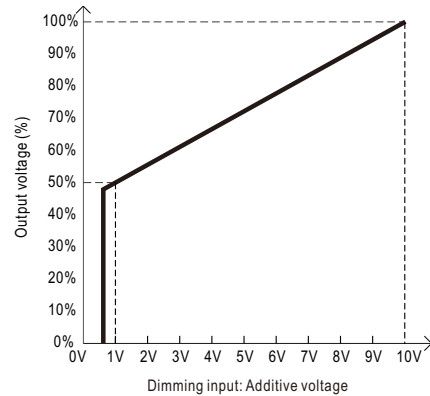

◎ Applying additive 10V PWM signal (frequency range 100Hz ~ 3KHz):

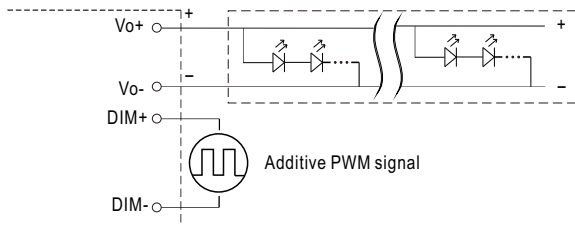

"DO NOT connect "DIM- to Vo-"

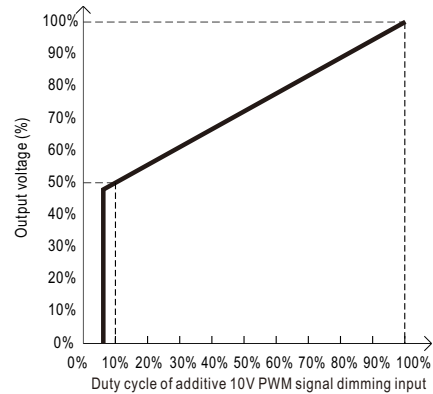

◎ Applying additive resistance:

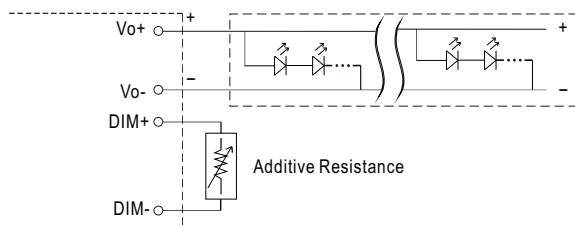

"DO NOT connect "DIM- to Vo-"

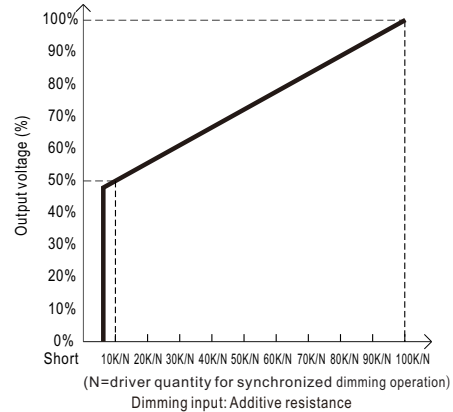

Note : 1. Min. dimming level is about 50% of output voltage and the output voltage is not defined when $V_{out} < 50\%$
 2. The output voltage could drop down to 0V when dimming input is about 0k or 0Vdc, or 10V PWM signal with 0% duty cycle.

OUTPUT LOAD vs TEMPERATURE

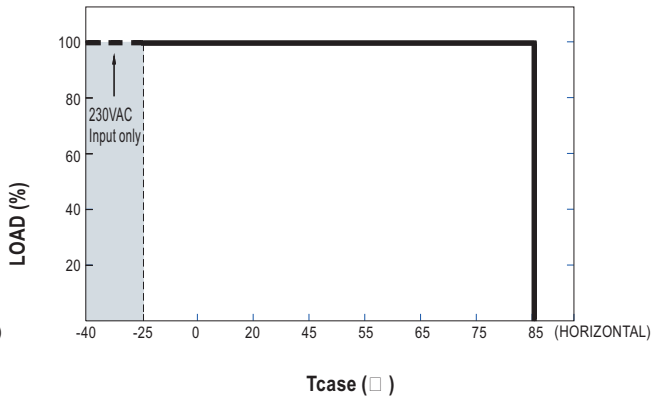
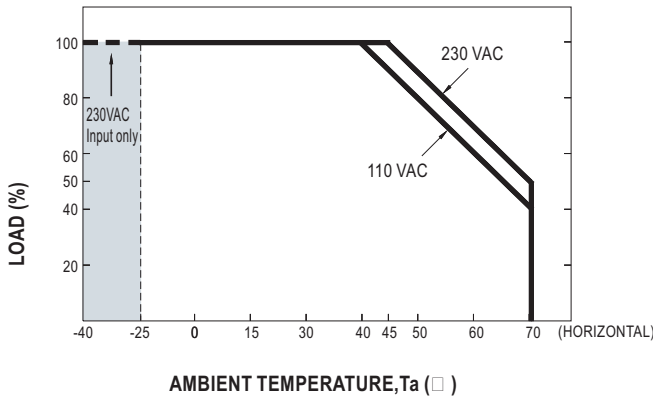

STATIC CHARACTERISTIC

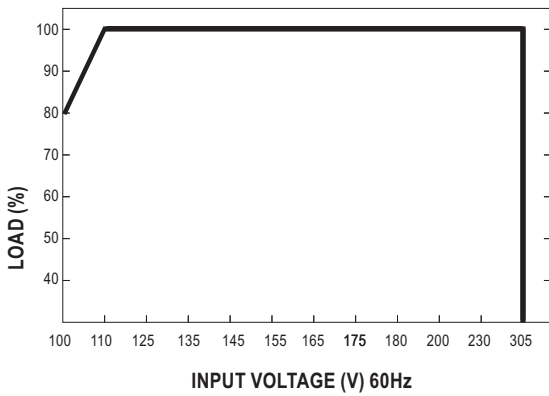

※ De-rating is needed under low input voltage.

POWER FACTOR (PF) CHARACTERISTIC

※ Tcase at 75°C

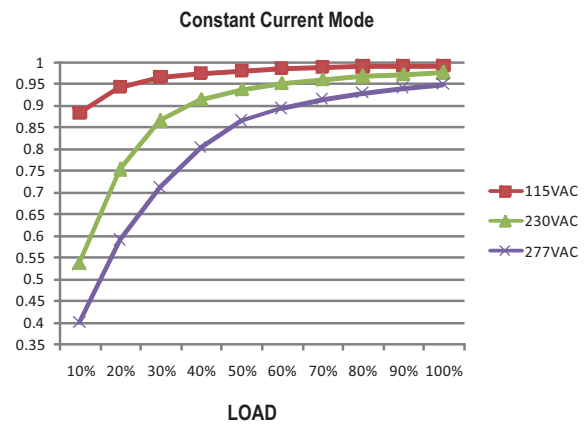

TOTAL HARMONIC DISTORTION (THD)

※ 48V Blank-Type Model, Tcase at 75°C

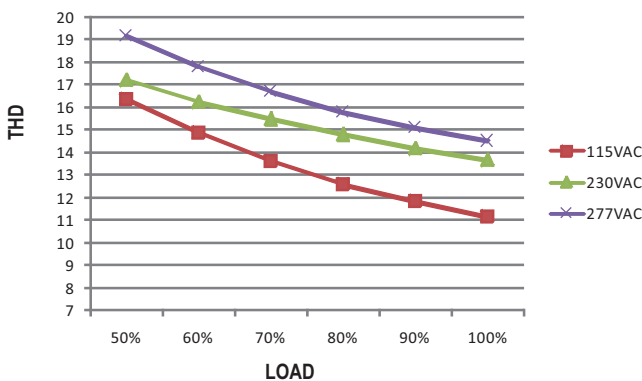

EFFICIENCY vs LOAD

NPF-200 series possess superior working efficiency that up to 94% can be reached in field applications.

※ 48V Blank-Type Model, Tcase at 75°C

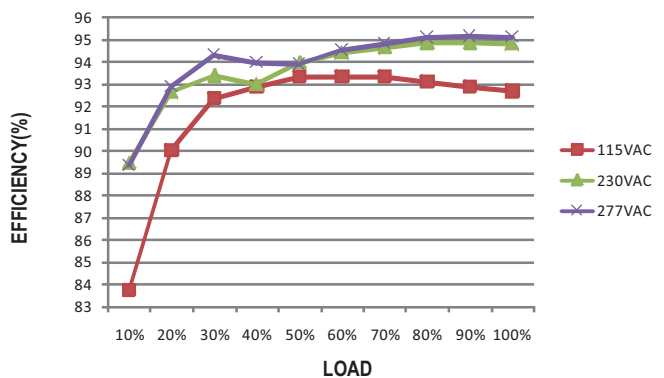



■ LIFE TIME

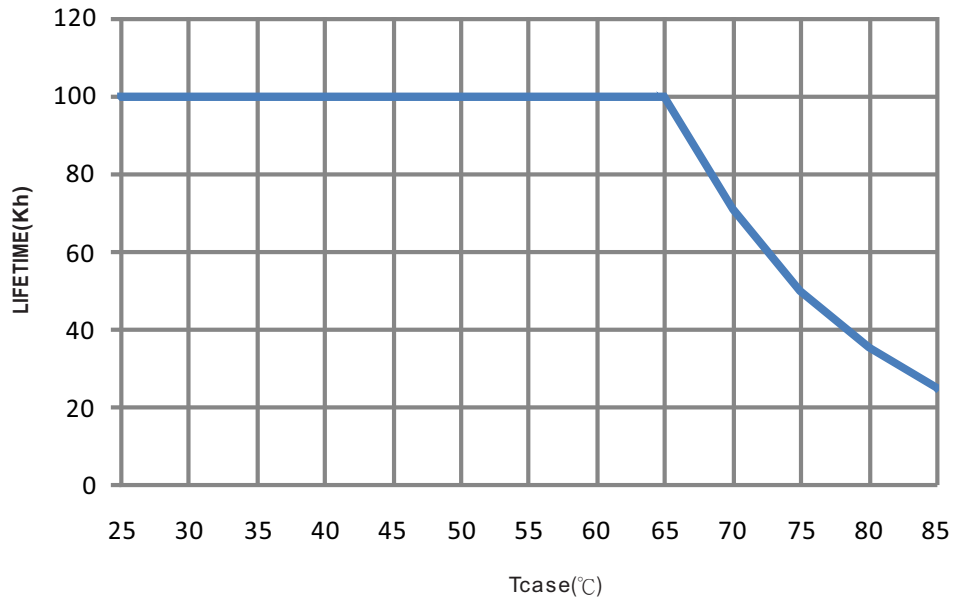

MECHANICAL SPECIFICATION

Case No. PWM-200

Unit:mm

※ Blank Type(C.C+C.V mode)

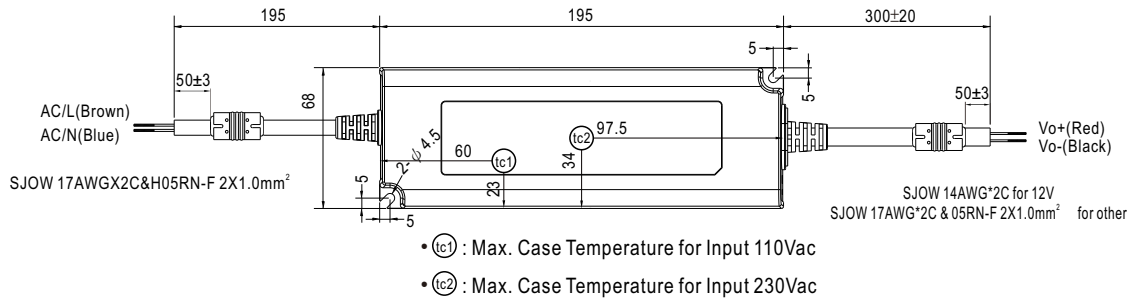

※ V-Type(C.V mode Dimming)

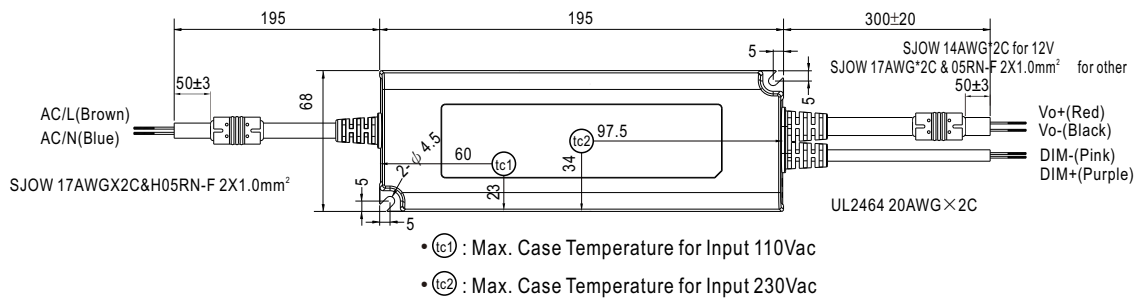

Recommend Mounting Direction



INSTALLATION MANUAL

Please refer to:<http://www.meanwell.com/manual.html>