



**BRIGHTTEK**  
**BRIGHTTEK (EUROPE) LIMITED**

*Brighten up The World With LED!*



ISO/TS 16949:2009



BS EN ISO 14001:2004



QC 080000 IECQ HSPM

## PRODUCT DATASHEET



- ▶ PCB / CHIP LED
- ▶ 1206 1.4t Series
- ▶ Yellow (590nm)

NOY11S03



Release Date: 16 March 2021 Version: A1.2

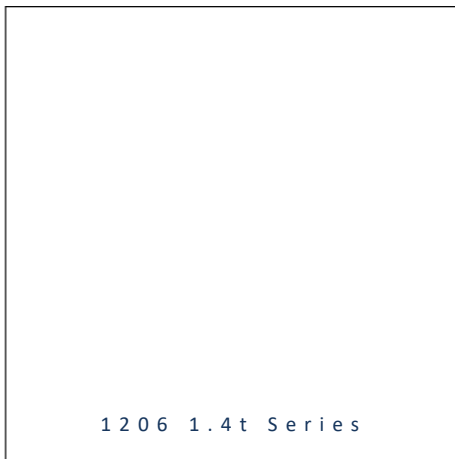

### 1206 1.4t Series

**RoHS**  
Compliant



#### FEATURES:

- **Package:** PCB / CHIP Top View LED
- **Forward Current:** 20mA
- **Forward Voltage (typ.):** 2.0V
- **Luminous Intensity (typ.):** 660mcd@20mA
- **Colour:** Yellow
- **Wavelength:** 590nm
- **Viewing angle:** 40°
- **Materials:**
  - Die: AlGaInP/GaAs
  - Resin: Epoxy (Water Clear)
- **Operating Temperature:** -40~+80°C
- **Storage Temperature:** -40~+85°C
- **Grouping parameters:**
  - Forward voltage
  - Luminous intensity
  - Dominant wavelength
- **Soldering methods:** Reflow
- **Preconditioning:** acc. to JEDEC Level 3
- **Packing:** 8mm tape with max.3000/reel, ø180mm (7")

#### APPLICATIONS:

- Indication Light
- Switch Light
- 3C Application

## CHARACTERISTICS:

### Absolute Maximum Characteristics (Ta=25°C)

Parameter	Symbol	Ratings	Unit
Forward Current	I <sub>F</sub>	30	mA
Peak Forward Current Duty 1/8@1KHz	I <sub>FP</sub>	125	mA
Reverse Voltage	V <sub>R</sub>	5	V
Reverse Current @5V	I <sub>R</sub>	10	μA
Power Dissipation	P <sub>D</sub>	75	mW
Operating Temperature	T <sub>OPR</sub>	-40~+80	°C
Storage Temperature	T <sub>STG</sub>	-40~+85	°C

### Electrical & Optical Characteristics (Ta=25°C)

Parameter	Symbol	Values			Unit	Test Condition
		Min.	Typ.	Max.		
Forward Voltage	V <sub>F</sub>	1.7	2.0	2.5	V	I <sub>F</sub> =20mA
Luminous Intensity	I <sub>v</sub>	400	660	1250	mcd	I <sub>F</sub> =20mA
Dominant Wavelength	λ <sub>D</sub>	585	590	595	nm	I <sub>F</sub> =20mA
Peak Wavelength	λ <sub>P</sub>	---	590	---	nm	I <sub>F</sub> =20mA
Spectral Line Half Bandwidth	Δλ	---	17	---	nm	I <sub>F</sub> =20mA
Viewing Angle	2θ <sub>1/2</sub>	---	40	---	deg	I <sub>F</sub> =20mA

1. Luminous intensity (I<sub>v</sub>) ±15%, Forward Voltage (V<sub>F</sub>) ±0.1V, Viewing angle(2θ<sub>1/2</sub>) ±5%

## OUTLINE DIMENSION:

Package Dimension:

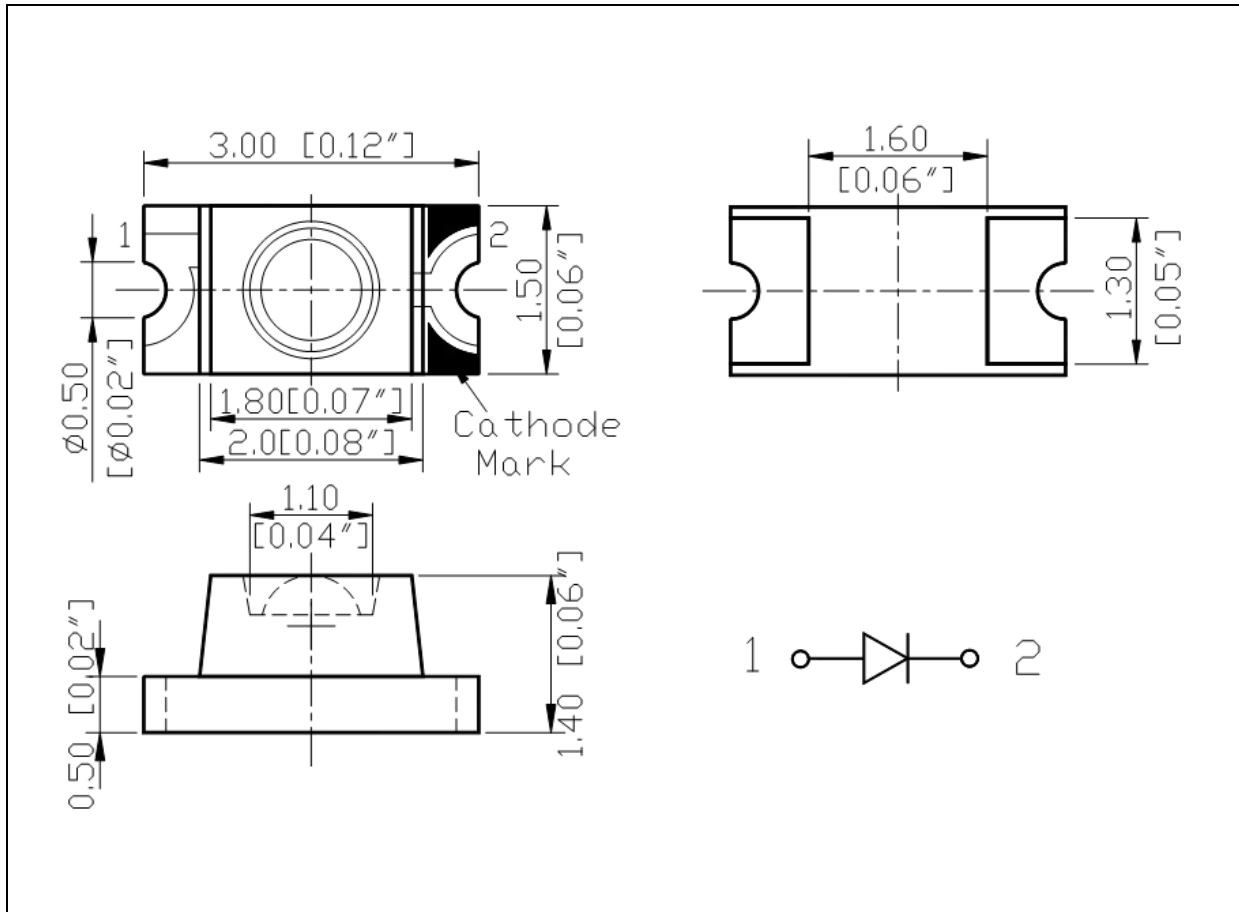

1. All dimensions are in millimetre (mm).
2. Tolerance  $\pm 0.2$ mm, unless otherwise noted.

Recommended Soldering Pad Dimension:

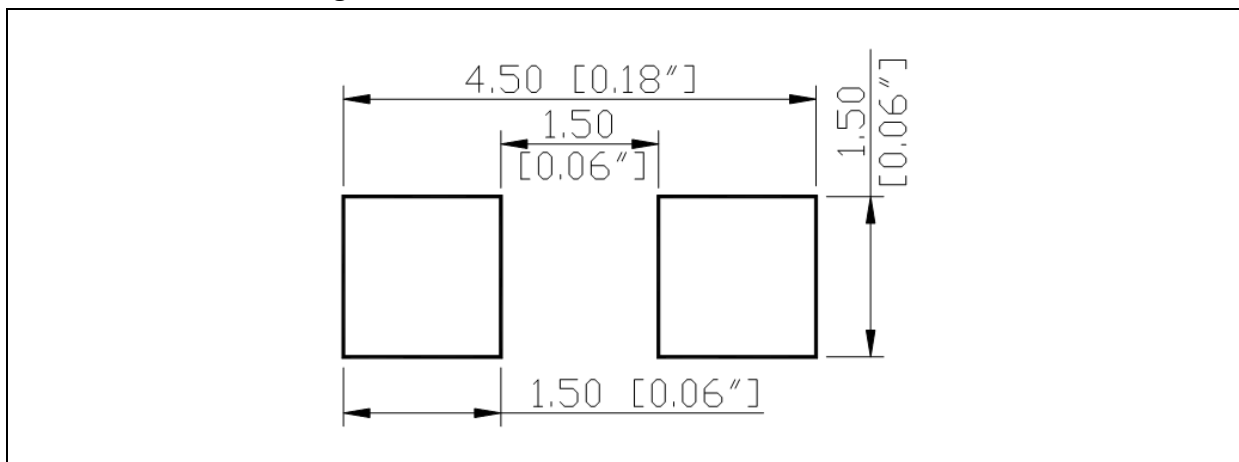

1. Dimensions are in millimetre (mm).
2. Tolerance  $\pm 0.1$ mm with angle tolerance  $\pm 0.5^\circ$ .

**BINNING GROUPS:**

---

 Forward Voltage Classifications ( $I_F = 20\text{mA}$ ):

Code	Min.	Max.	Unit
□	1.7	2.5	V

 Luminous Intensity Classifications ( $I_F = 20\text{mA}$ ):

Code	Min.	Max.	Unit
P	400	500	mcd
Q	500	630	
R	630	800	
S	800	1000	
T	1000	1250	

 Dominant Wavelength Classifications ( $I_F = 20\text{mA}$ ):

Code	Min.	Max.	Unit
m	585	590	nm
n	590	595	

Example Group Name on Label:

- □ **Rm20** = □ (1.7~2.5V) ► **R** (630~800mcd) ► **M** (585~590nm) ► **20** ( $I_F=20\text{mA}$ )

**ELECTRO-OPTICAL CHARACTERISTICS:**

**Forward Current v.s. Luminous Intensity**

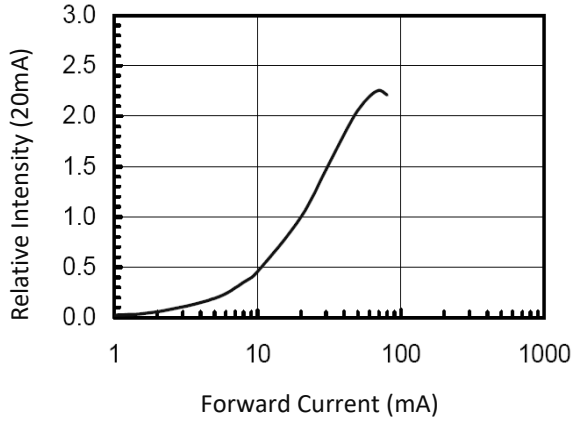

**Forward Current v.s. Forward Voltage**

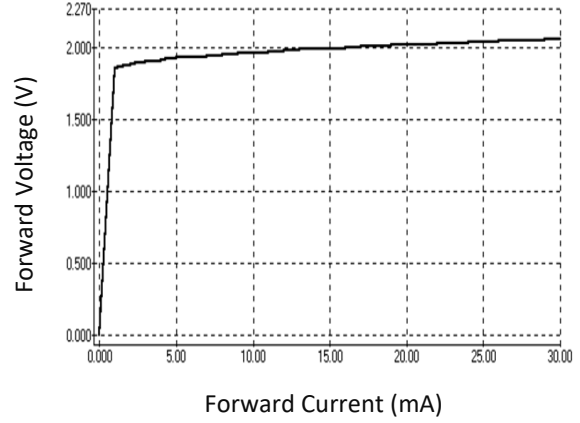

**Relative Spectral Distribution**

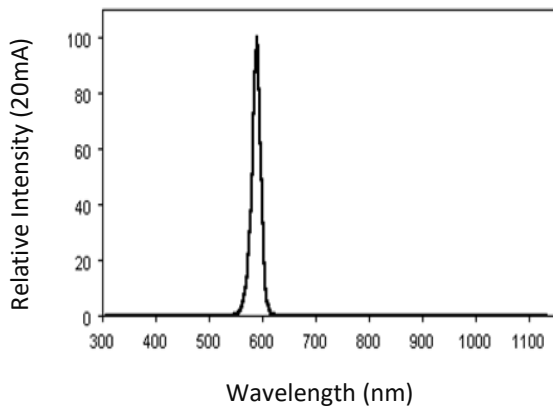

**Directive Radiation**

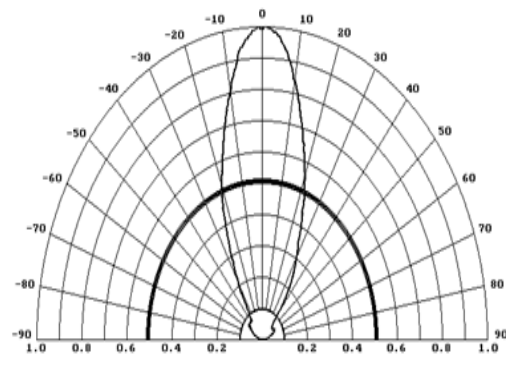

## RECOMMENDED SOLDERING PROFILE:

Reflow Solder:

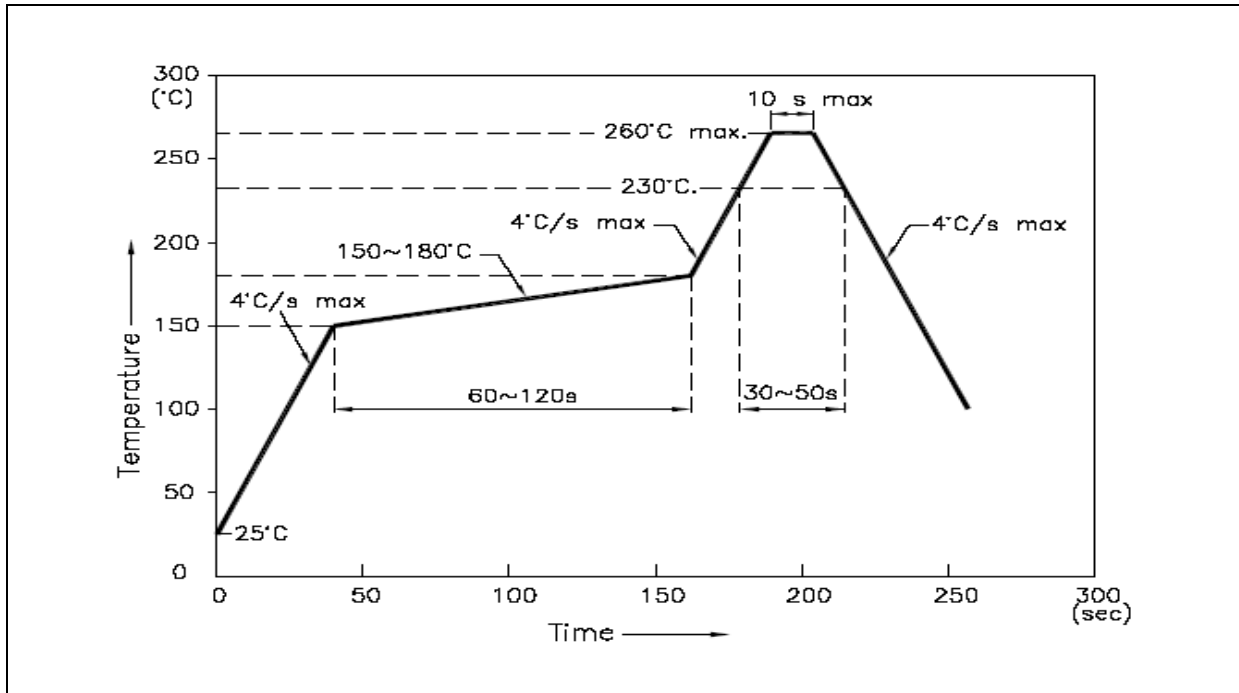

Note:

1. Recommend reflow temperature 245°C. The maximum soldering temperature should be limited to 260°C.
2. Maxima reflow soldering: 2 times.
3. Before, during, and after soldering, should not apply stress on the components and PCB board.

**PACKING SPECIFICATION:**

Reel Dimension:

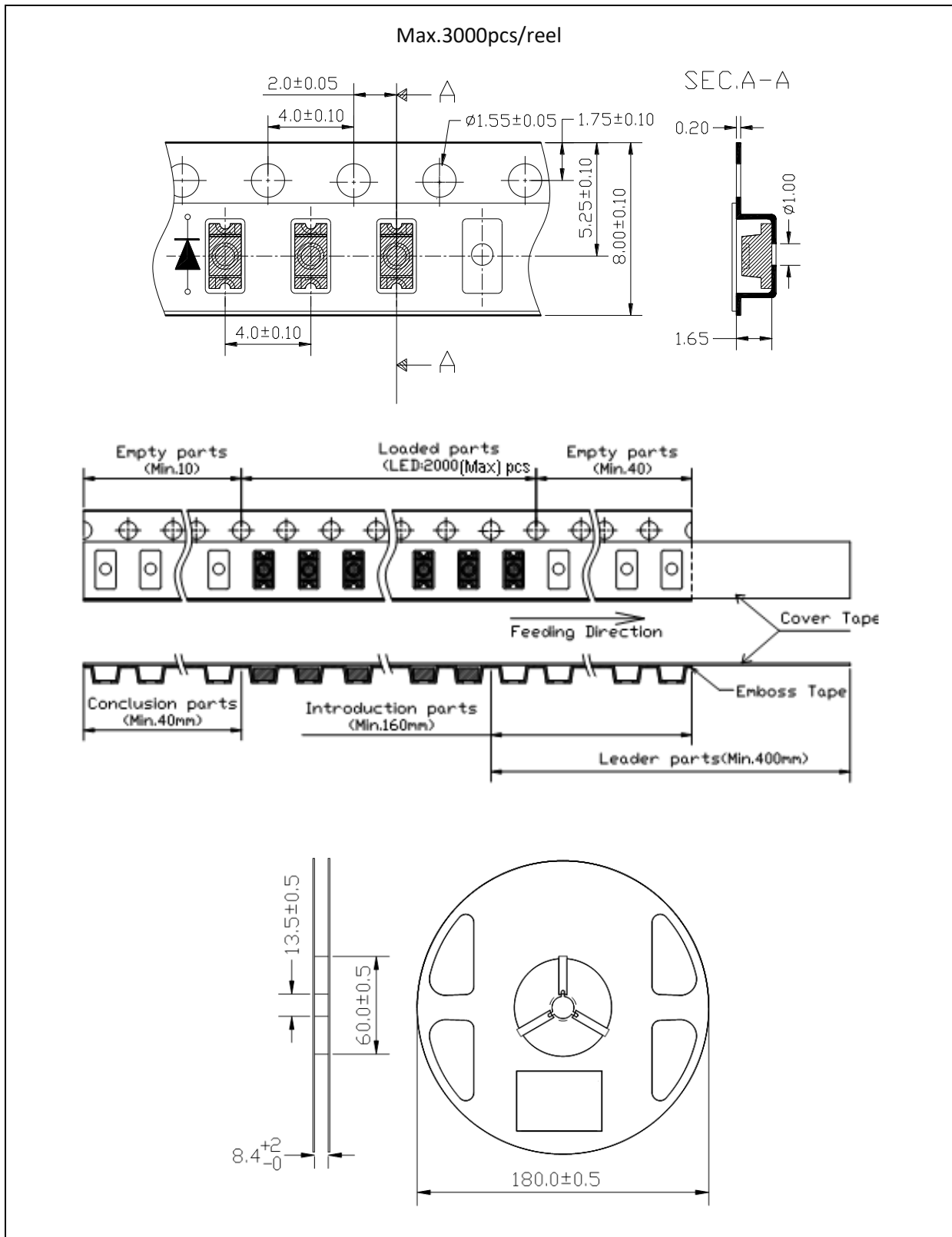

## PRECAUTIONS OF USE:

---

### Storage:

It is recommended to store the products in the following conditions:

- Humidity: 60% R.H. Max.
- Temperature: 5°C~30°C (41°F ~86°F).

Shelf life in sealed bag: 12 month at 5°C~30°C and <60% R.H.

Once the package is opened, the products should be used within a week. Otherwise, they should be kept in a damp-proof box with desiccating agent <10% R.H. and apply baking before use.

### Baking:

It is recommended to bake the LED before soldering if the pack has been unsealed for longer than 24hrs. The suggested baking conditions are as followings:

- 60±3°C x 24hrs and <5%RH, taped / reel package.

It's normal to see slight color fading of carrier (light yellow) after baking in process.

### Testing Circuit:

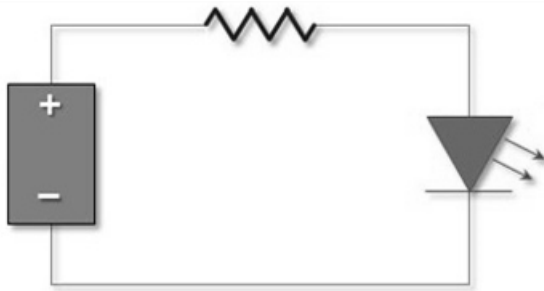

Must apply resistor(s) for protection (over current proof).

### Cleaning:

Use alcohol-based cleaning solvents such as isopropyl alcohol to clean the LED carrier / package. Avoid putting any stress force directly on to the LED lens.

### ESD (Electrostatic Discharge):

Static Electricity or power surge will damage the LED. Use of a conductive wrist band or anti-electrostatic glove is recommended when handling the LED all time. All devices, equipment, machinery, work tables, and storage racks must be properly grounded.

In the events of manual working in process, make sure the devices are well protected from ESD at any time.



**REVISION RECORD:**

---

Version	Date	Summary of Revision
A1.0	28/07/2014	Datasheet set-up.
A1.1	26/03/2015	Add height info.
A1.2	16/03/2021	Add current v.s. intensity chart.