



**BRIGHTTEK**  
**BRIGHTTEK (EUROPE) LIMITED**

*Brighten Up The World With LED!*



ISO/TS 16949:2009



BS EN ISO 14001:2004



QC 080000 IECQ HSPM

## PRODUCT DATASHEET



- ▶ PLCC2 Top View
- ▶ 3528+Lens 3.6t Series
- ▶ Red (625nm)

NOR17S18 (13" reel)

NOR17S18SR (7" reel)



Release Date: 20 October 2022 Version: A1.1

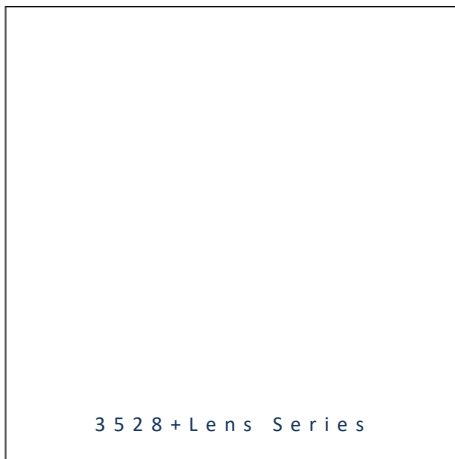

3528+Lens Series

### 3528+Lens Series

**RoHS**  
Compliant



#### FEATURES:

- **Package:** PLCC2 Black Surface SMT Package with Lens
- **Forward Current:** 20mA
- **Forward Voltage (typ.):** 2.0V
- **Luminous Intensity (typ.):** 7000mcd@20mA
- **Colour:** Red
- **Wavelength:** 625nm
- **Viewing angle:** 30°
- **Materials:**
  - Die: AlInGaP
  - Resin: Epoxy (Water Clear)
  - L/F Finish: Ag Plated
- **Operating Temperature:** -40~+80°C
- **Storage Temperature:** -40~+85°C
- **Grouping parameters:**
  - Forward voltage
  - Luminous intensity
  - Dominant Wavelength
- **Soldering methods:** Reflow soldering
- **MSL:** acc. to JEDEC Level 3
- **Packing:** 12mm tape with max.2000pcs/reel, ø330mm (13") or max.600pcs/reel ø180mm (7")

#### APPLICATIONS:

- LED Display
- Indicator
- Traffic Display
- Decoration Lighting

## CHARACTERISTICS:

### Absolute Maximum Characteristics (Ta=25°C)

Parameter	Symbol	Ratings	Unit
Forward Current	I <sub>F</sub>	30	mA
Peak Forward Current Duty 1/8@1KHz	I <sub>FP</sub>	125	mA
Reverse Voltage	V <sub>R</sub>	5	V
Reverse Current @5V	I <sub>R</sub>	10	μA
Power Dissipation	P <sub>D</sub>	75	mW
Operating Temperature	T <sub>OPR</sub>	-40~+80	°C
Storage Temperature	T <sub>STG</sub>	-40~+85	°C

### Electrical & Optical Characteristics (Ta=25°C)

Parameter	Symbol	Values			Unit	Test Condition
		Min.	Typ.	Max.		
Forward Voltage	V <sub>F</sub>	1.7	2.0	2.5	V	I <sub>F</sub> =20mA
Luminous Intensity	I <sub>v</sub>	3200	7000	11200	mcd	I <sub>F</sub> =20mA
Dominant Wavelength	λ <sub>D</sub>	620	625	630	nm	I <sub>F</sub> =20mA
Peak Wavelength	λ <sub>P</sub>	---	630	---	nm	I <sub>F</sub> =20mA
Spectral Half Bandwidth	Δλ	---	18	---	nm	I <sub>F</sub> =20mA
Viewing Angle	2θ <sub>1/2</sub>	---	30	---	deg	I <sub>F</sub> =20mA

- Luminous intensity (I<sub>v</sub>) ±15%, Forward Voltage (V<sub>F</sub>) ±0.1V, Viewing angle(2θ<sub>1/2</sub>) ±5%

## OUTLINE DIMENSION:

Package Dimension:

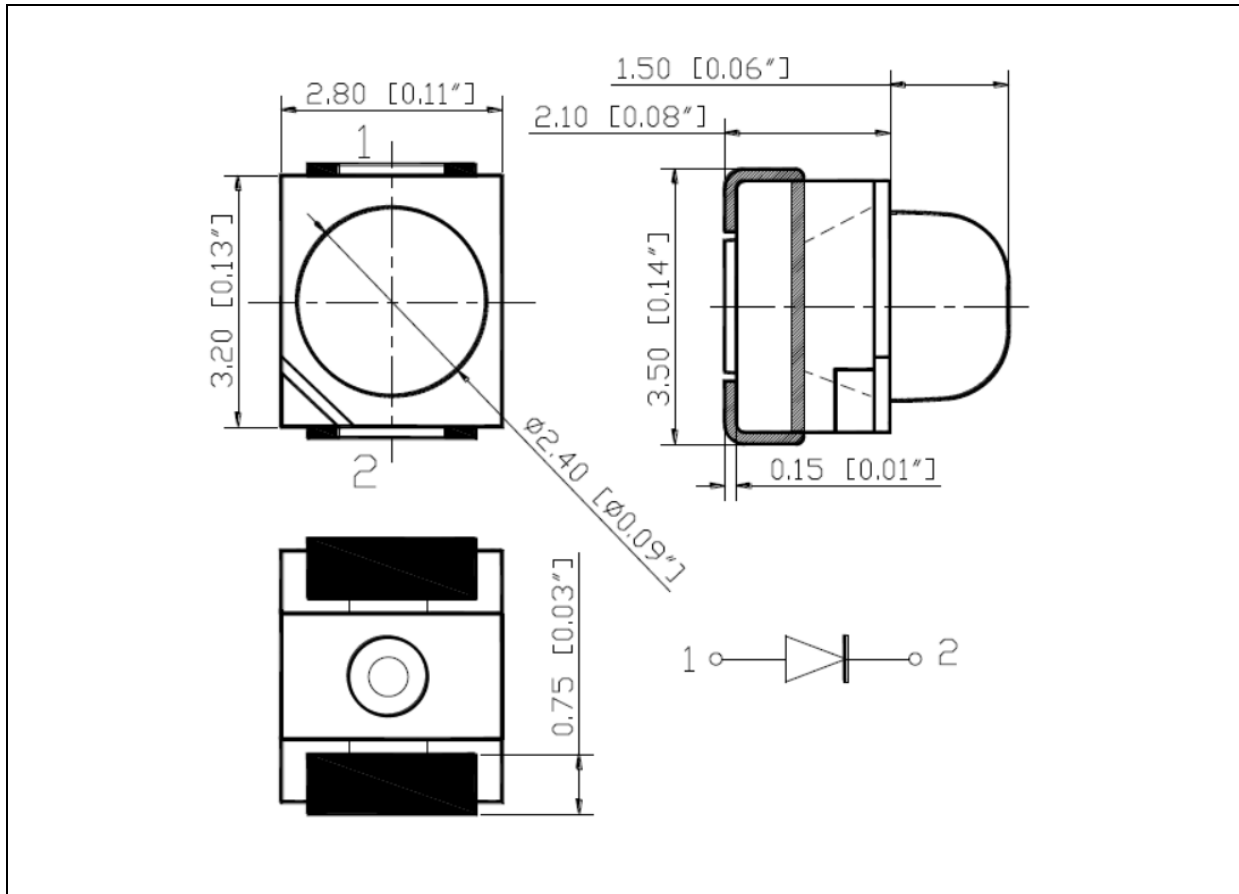

1. All dimensions are in millimetre (mm).
2. Tolerance  $\pm 0.2\text{mm}$ , unless otherwise noted.

Recommended Soldering Pad Dimension:

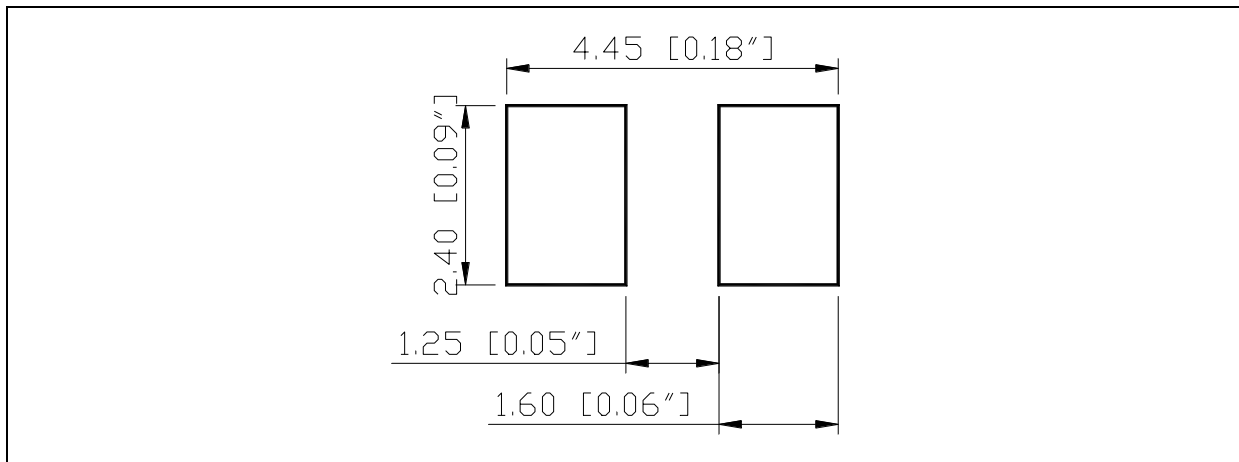

1. Dimensions are in millimetre (mm).
2. Tolerance  $\pm 0.1\text{mm}$  with angle tolerance  $\pm 0.5^\circ$ .

**BINNING GROUPS:**

---

 Forward Voltage Classifications ( $I_F = 20\text{mA}$ ):

Code	Min.	Max.	Unit
□	1.7	2.5	V

 Luminous Intensity Classifications ( $I_F = 20\text{mA}$ ):

Code	Min.	Max.	Unit
Y	3200	4000	mcd
Z	4000	5200	
a	5200	6800	
b	6800	8800	
c	8800	11200	

 Wavelength Classifications ( $I_F = 20\text{mA}$ ):

Code	Min.	Max.	Unit
t	620	625	nm
u	625	630	

Example Binning Information on Label:

Code	$V_f$ (V)	$I_v$ (mcd)	$\lambda_d$ (nm)	Test Condition
□bt 20	□= 1.7~2.5	b= 6800~8800	t= 620~625	20= 20mA

**ELECTRO-OPTICAL CHARACTERISTICS:**

Relative Spectral Distribution

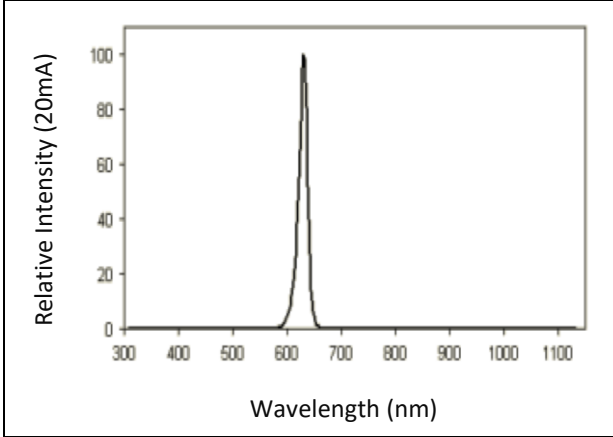

Forward Current v.s. Forward Voltage

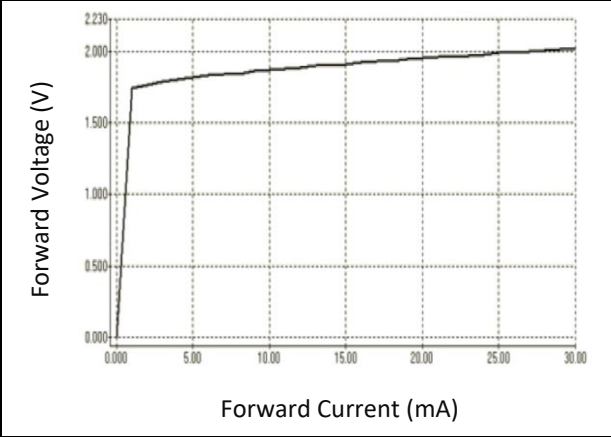

Directive Radiation

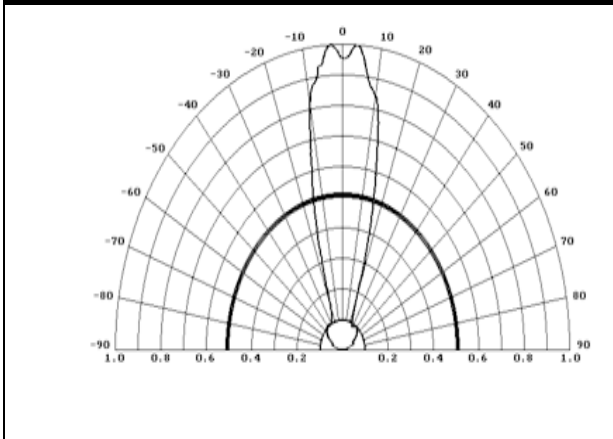

## RECOMMENDED SOLDERING PROFILE:

---

Lead-free Solder:

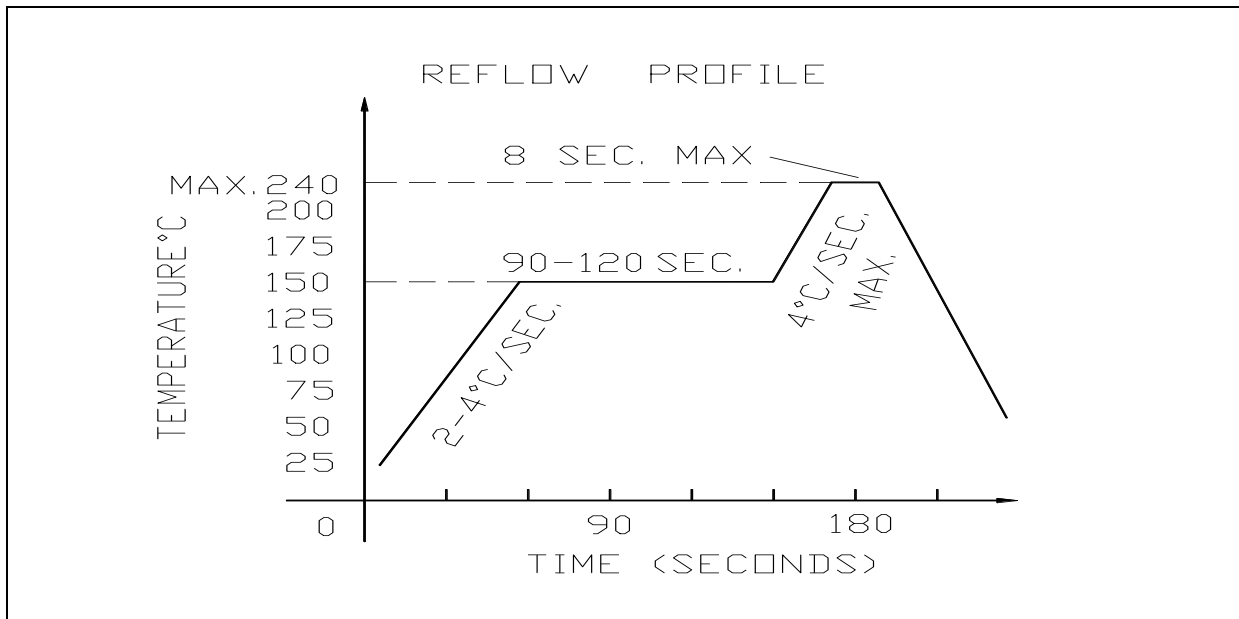

Note:

1. Maximum reflow soldering: 1 time.
2. The maximum soldering temperature is 240°C.
3. Before, during, and after soldering, should not apply stress on the components and PCB board.

**PACKING SPECIFICATION:**

NOR17S18 - 13" Reel Dimension:

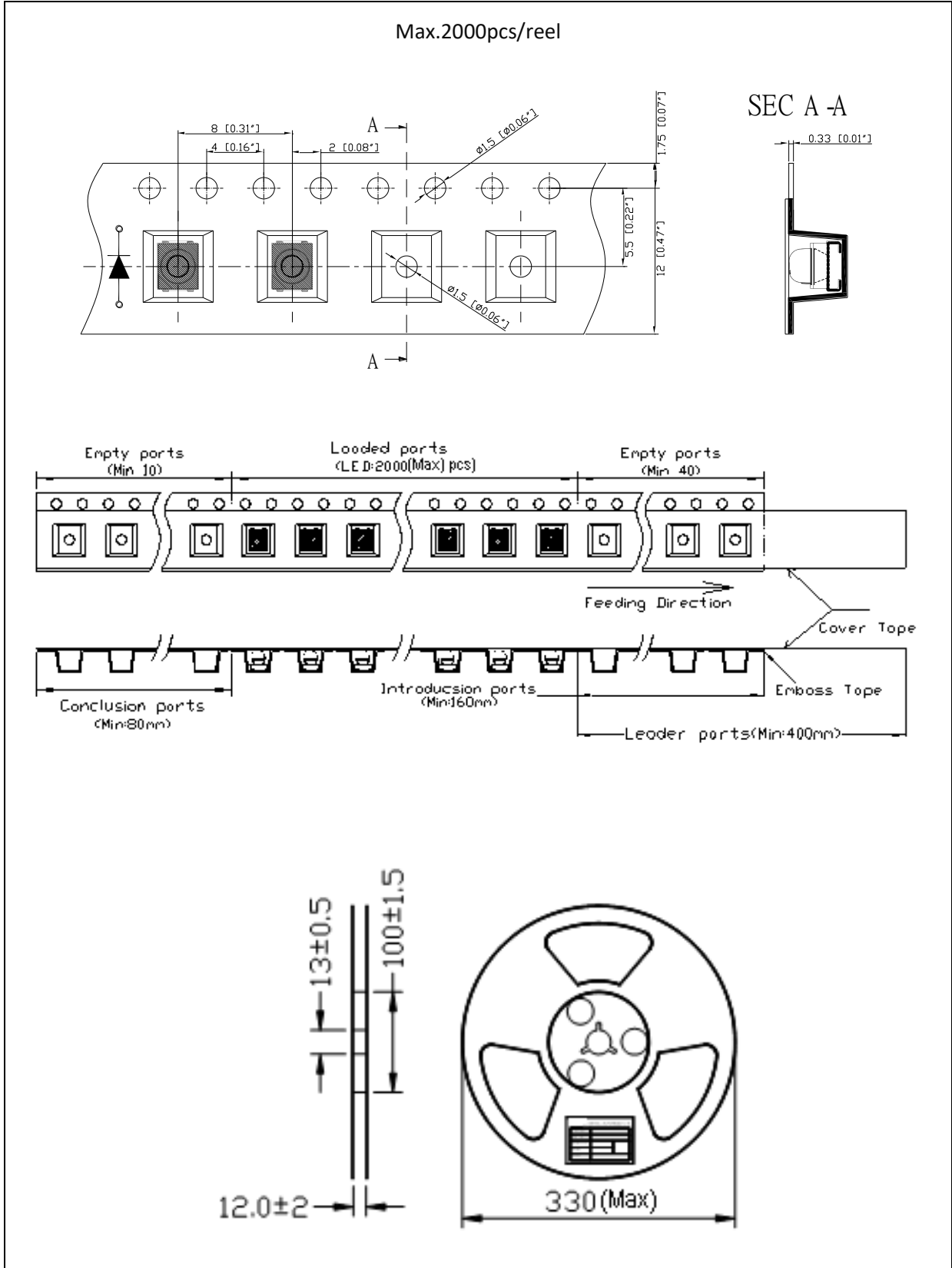

NOR17S18SR - 7" Reel Dimension:

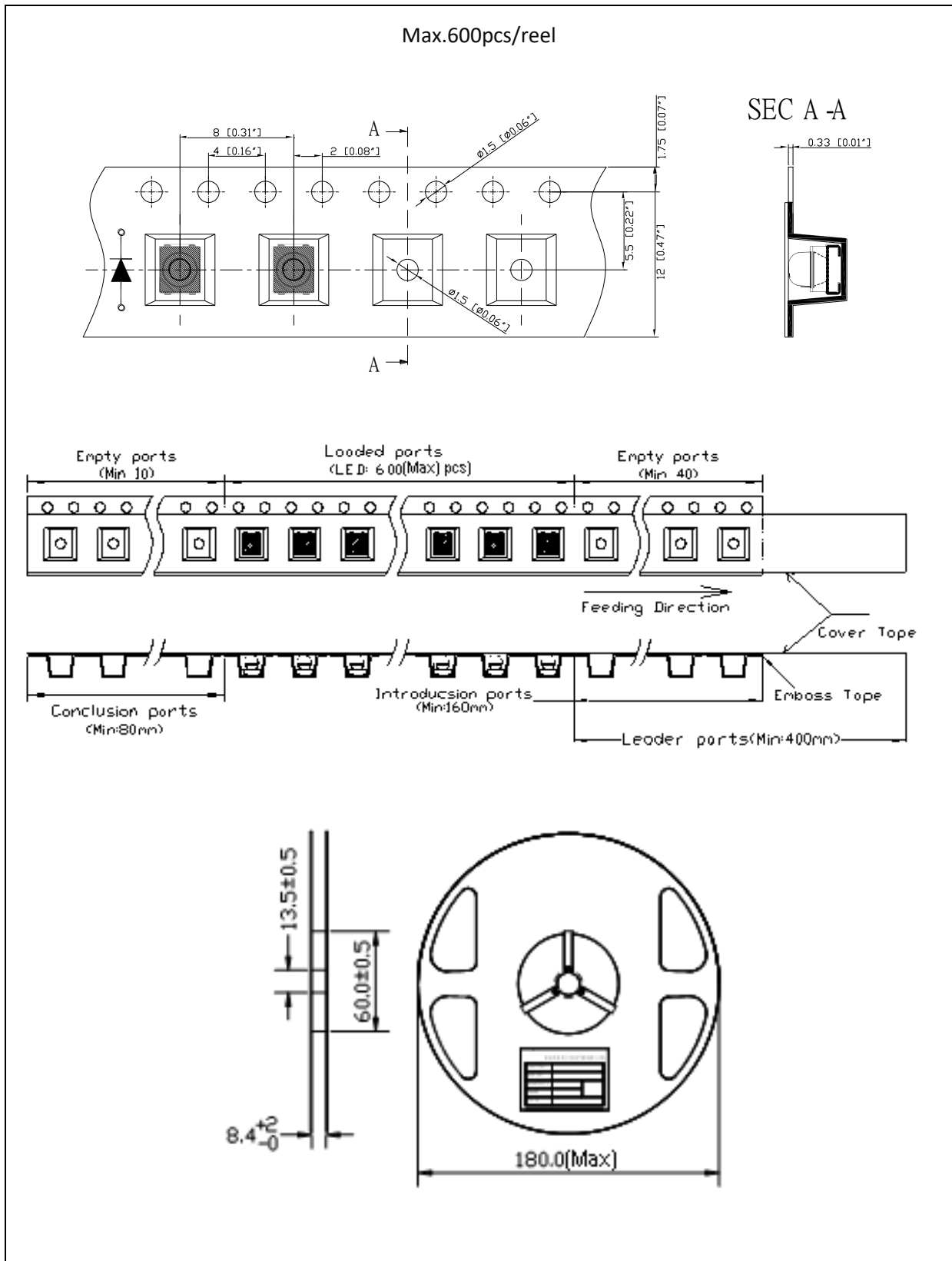



## PRECAUTIONS OF USE:

---

### Storage:

It is recommended to store the products in the following conditions:

- Humidity: 60% R.H. Max.
- Temperature: 5°C~30°C (41°F ~86°F).

Shelf life in sealed bag: 12 months at 5°C~30°C and <60% R.H.

Once the package is opened, the products should be used within a week. Otherwise, they should be kept in a damp-proof box with desiccating agent <10% R.H. and apply baking.

### Baking:

It is recommended to bake the LED before soldering if the pack has been unsealed for longer than 24hrs. The suggested baking conditions are as followings:

- 60±3°C x 24hrs and <5%RH, taped / reel package.

It's normal to see slight color fading of carrier (light yellow) after baking in process.

### Testing Circuit:

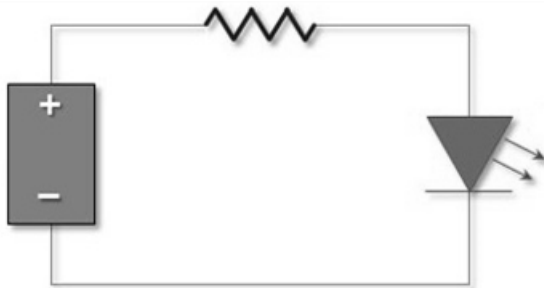

Must apply resistor(s) for protection (over current proof).

### Cleaning:

Use alcohol-based cleaning solvents such as isopropyl alcohol to clean the LED carrier / package. Avoid putting any stress force directly on to the LED lens.

### ESD (Electrostatic Discharge):

Static Electricity or power surge will damage the LED. Use of a conductive wrist band or anti-electrostatic glove is recommended when handling the LED all time. All devices, equipment, machinery, work tables, and storage racks must be properly grounded.

In the events of manual working in process, make sure the devices are well protected from ESD at any time.

**REVISION RECORD:**

---

Version	Date	Summary of Revision
A1.0	10/12/2013	Datasheet set-up.
A1.1	20/10/2022	New datasheet format.