

+3.3V, 1Mbps, Low-Supply-Current CAN Transceiver

General Description

The MAX3051 interfaces between the CAN protocol controller and the physical wires of the bus lines in a controller area network (CAN). The MAX3051 provides differential transmit capability to the bus and differential receive capability to the CAN controller. The MAX3051 is primarily intended for +3.3V single-supply applications that do not require the stringent fault protection specified by the automotive industry (ISO 11898).

The MAX3051 features four different modes of operation: high-speed, slope-control, standby, and shutdown mode. High-speed mode allows data rates up to 1Mbps. The slope-control mode can be used to program the slew rate of the transmitter for data rates of up to 500kbps. This reduces the effects of EMI, thus allowing the use of unshielded twisted or parallel cable. In standby mode, the transmitter is shut off and the receiver is pulled high, placing the MAX3051 in low-current mode. In shutdown mode, the transmitter and receiver are switched off.

The MAX3051 input common-mode range is from -7V to +12V, exceeding the ISO 11898 specification of -2V to +7V. These features, and the programmable slew-rate limiting, make the part ideal for nonautomotive, harsh environments. The MAX3051 is available in 8-pin SO and SOT23 packages and operates over the -40°C to +85°C extended temperature range.

Applications

Printers JetLink
Industrial Control and Networks
Telecom Backplane
Consumer Applications

Typical Operating Circuit at end of data sheet.

Features

- ◆ Low +3.3V Single-Supply Operation
- ◆ ESD Protection
±12kV Human Body Model
- ◆ Wide -7V to +12V Common-Mode Range
- ◆ Small SOT23 Package
- ◆ Four Operating Modes
High-Speed Operation Up to 1Mbps
Slope-Control Mode to Reduce EMI (Up to 500kbps)
Standby Mode
Low-Current Shutdown Mode
- ◆ Thermal Shutdown
- ◆ Current Limiting

Ordering Information

PART	TEMP RANGE	PIN-PACKAGE	TOP MARK
MAX3051ESA+	-40°C to +85°C	8 SO	—
MAX3051EKA+T	-40°C to +85°C	8 SOT23-8	AEKF

+ Denotes a lead(Pb)-free/RoHS-compliant package.
T = Tape and reel

Pin Configuration

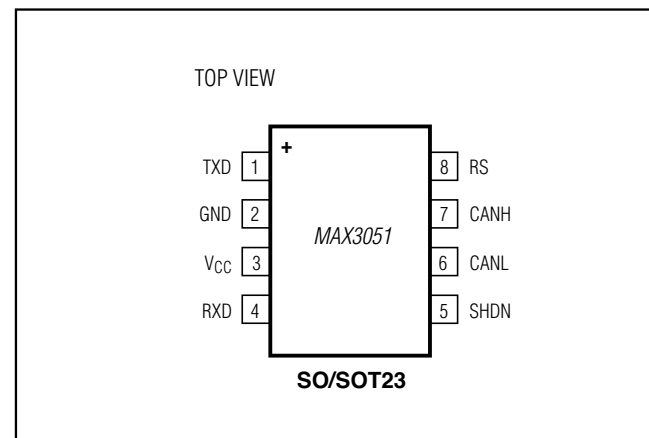

MAX3051

+3.3V, 1Mbps, Low-Supply-Current CAN Transceiver

ABSOLUTE MAXIMUM RATINGS

V _{CC} to GND	-0.3V to +6V
TXD, RS, SHDN to GND	-0.3V to +6V
RXD to GND	-0.3V to +6V
CANH, CANL to GND	-7.5V to +12.5V
Continuous Power Dissipation (T _A = +70°C)	
8-Pin SO (derate 5.9mW/°C above +70°C)	470mW
8-Pin SOT23 (derate 5.1mW/°C above +70°C)	408.2mW

Operating Temperature Range	-40°C to +85°C
Maximum Junction Temperature	+150°C
Storage Temperature Range	-65°C to +150°C
Lead Temperature Range (soldering, 10s)	+300°C
Soldering Temperature (reflow)	+260°C

Stresses beyond those listed under "Absolute Maximum Ratings" may cause permanent damage to the device. These are stress ratings only, and functional operation of the device at these or any other conditions beyond those indicated in the operational sections of the specifications is not implied. Exposure to absolute maximum rating conditions for extended periods may affect device reliability.

ELECTRICAL CHARACTERISTICS

(V_{CC} = +3.3V ±5%, R_L = 60Ω, C_L = 100pF, T_A = T_{MIN} to T_{MAX}, unless otherwise noted. Typical values are at V_{CC} = +3.3V and T_A = +25°C.) (Note 1)

PARAMETER	SYMBOL	CONDITIONS	MIN	TYP	MAX	UNITS
Supply Current	I _S	Dominant		35	70	mA
		Recessive		2	5	
		Standby		8	15	μA
Shutdown Current	I _{SHDN}	V _{SHDN} = V _{CC} , TXD = V _{CC} or unconnected			1	μA
Thermal-Shutdown Threshold	V _{TSH}			+160		°C
Thermal-Shutdown Hysteresis				25		°C
TXD INPUT LEVELS						
High-Level Input Voltage	V _{IH}		2		V _{CC} + 0.3V	V
Low-Level Input Voltage	V _{IL}				0.8	V
Input Capacitance	C _{IN}			5		pF
Pullup Resistor	R _{INTXD}		50		100	kΩ
CANH, CANL TRANSMITTER						
Recessive Bus Voltage	V _{CANH} , V _{CANL}	V _{TXD} = V _{CC} , no load	2	2.3	3	V
		V _{TXD} = V _{CC} , no load, V _{RS} = V _{CC} (standby mode)	-100		+100	mV
Off-State Output Leakage		-2V < V _{CANH} , V _{CANL} < +7V, SHDN = HIGH	-250		+250	μA
Input Leakage Current		V _{CC} = 0V, V _{CANH} = V _{CANL} = 5V	-250		+250	μA
CANH Output Voltage	V _{CANH}	V _{TXD} = 0V	2.45			V
CANL Output Voltage	V _{CANL}	V _{TXD} = 0V			1.25	V
Differential Output	(V _{CANH} - V _{CANL})	V _{TXD} = 0V	1.5		3.0	V
		V _{TXD} = 0V, R _L = 45Ω	1.2		3.0	
		V _{TXD} = V _{CC} , no load	-500		+50	mV
		V _{TXD} = V _{CC} , R _L = 60Ω	-120		+12	

MAX3051

+3.3V, 1Mbps, Low-Supply-Current CAN Transceiver

ELECTRICAL CHARACTERISTICS (continued)

($V_{CC} = +3.3V \pm 5\%$, $R_L = 60\Omega$, $C_L = 100pF$, $T_A = T_{MIN}$ to T_{MAX} , unless otherwise noted. Typical values are at $V_{CC} = +3.3V$ and $T_A = +25^\circ C$.) (Note 1)

PARAMETER	SYMBOL	CONDITIONS	MIN	TYP	MAX	UNITS
CANH Short-Circuit Current	I _{CANHSC}	$-7V \leq V_{CANH} \leq 0V$	-200			mA
		Minimum foldback current			-35	
CANL Short-Circuit Current	I _{CANLSC}	$V_{CC} \leq V_{CANL} \leq 12V$			200	mA
RXD OUTPUT LEVELS						
RXD High Output-Voltage Level	V _{OH}	I = -1mA	0.8 x V _{CC}		V _{CC}	V
RXD Low Output-Voltage Level	V _{OL}	I = 4mA			0.4	V
DC BUS RECEIVER (V_{TXD} = V_{CC}; CANH and CANL externally driven; $-7V \leq V_{CANH}$, $V_{CANL} \leq +12V$, unless otherwise specified)						
Differential Input Voltage (Recessive)	V _{DIFF}	$-7V \leq V_{CM} \leq +12V$	0.5			V
		V _{RS} = V _{CC} (standby mode)	0.5			
Differential Input Voltage (Dominant)	V _{DIFF}	Dominant			0.9	V
		V _{RS} = V _{CC} (standby mode)			1.1	
Differential Input Hysteresis	V _{DIFF(HYST)}			20		mV
CANH and CANL Input Resistance	R _I		20		50	k Ω
Differential Input Resistance	R _{DIFF}		40		100	k Ω
MODE SELECTION (RS)						
Input Voltage for High Speed	V _{SLP}				0.3 x V _{CC}	V
Input Voltage for Standby	V _{STBY}		0.75 x V _{CC}			V
Slope-Control Mode Voltage	V _{SLOPE}	R _{RS} = 25k Ω to 200k Ω	0.4 x V _{CC}		0.6 x V _{CC}	V
High-Speed Mode Current	I _{HS}	V _{RS} = 0V			-500	μA
SHUTDOWN (SHDN)						
SHDN Input Voltage High	V _{SHDNH}		2			V
SHDN Input Voltage Low	V _{SHDNL}				0.8	V
SHDN Pulldown Resistor	R _{INSHDN}		50		100	k Ω

MAX3051

+3.3V, 1Mbps, Low-Supply-Current CAN Transceiver

TIMING CHARACTERISTICS

($V_{CC} = +3.3V \pm 5\%$, $R_L = 60\Omega$, $C_L = 100pF$, $T_A = T_{MIN}$ to T_{MAX} , unless otherwise noted. Typical values are at $V_{CC} = +3.3V$ and $T_A = +25^\circ C$.)

PARAMETER	SYMBOL	CONDITIONS	MIN	TYP	MAX	UNITS
Delay TXD to Bus Active (Figure 1)	t _{ONTXD}	V _{RS} = 0V ($\leq 1Mbps$)			50	ns
		R _{RS} = 25k Ω ($\leq 500kbps$)		183		
		R _{RS} = 100k Ω ($\leq 125kbps$)		770		
Delay TXD to Bus Inactive (Figure 1)	t _{OFFTXD}	V _{RS} = 0V ($\leq 1Mbps$)			70	ns
		R _{RS} = 25k Ω ($\leq 500kbps$)		226		
		R _{RS} = 100k Ω ($\leq 125kbps$)		834		
Delay Bus to Receiver Active (Figure 1)	t _{ONRXD}	V _{RS} = 0V ($\leq 1Mbps$)			80	ns
		R _{RS} = 25k Ω ($\leq 500kbps$)		200		
		R _{RS} = 100k Ω ($\leq 125kbps$)		730		
Delay Bus to Receiver Inactive (Figure 1)	t _{OFFRXD}	V _{RS} = 0V ($\leq 1Mbps$)			100	ns
		R _{RS} = 25k Ω ($\leq 500kbps$)		245		
		R _{RS} = 100k Ω ($\leq 125kbps$)		800		
Differential-Output Slew Rate	SR	V _{RS} = 0V ($\leq 1Mbps$)		96		V/ μs
		R _{RS} = 25k Ω ($\leq 500kbps$)		12.5		
		R _{RS} = 100k Ω ($\leq 125kbps$)		2.9		
		R _{RS} = 200k Ω ($\leq 62.5kbps$)		1.6		
Bus Dominant to RXD Active	t _{DRXDL}	V _{RS} > 0.8 x V _{CC} , standby, Figure 2			1	μs
Standby to Receiver Active	t _{SBRXDL}	BUS dominant, Figure 2			4	μs
SHDN to Bus Inactive	t _{OFFSHDN}	TXD = GND, Figure 3 (Note 2)			1	μs
SHDN to Receiver Active	t _{ONSHDN}	BUS dominant, Figure 3 (Note 3)			4	μs
SHDN to Standby	t _{SHDNSB}	Figure 4	20			μs
ESD Protection		Human Body Model		± 12		kV

Note 1: All currents into device are positive; all currents out of the device are negative. All voltages are referenced to device ground, unless otherwise noted.

Note 2: No other devices on the BUS.

Note 3: BUS externally driven.

MAX3051

+3.3V, 1Mbps, Low-Supply-Current CAN Transceiver

Timing Diagrams

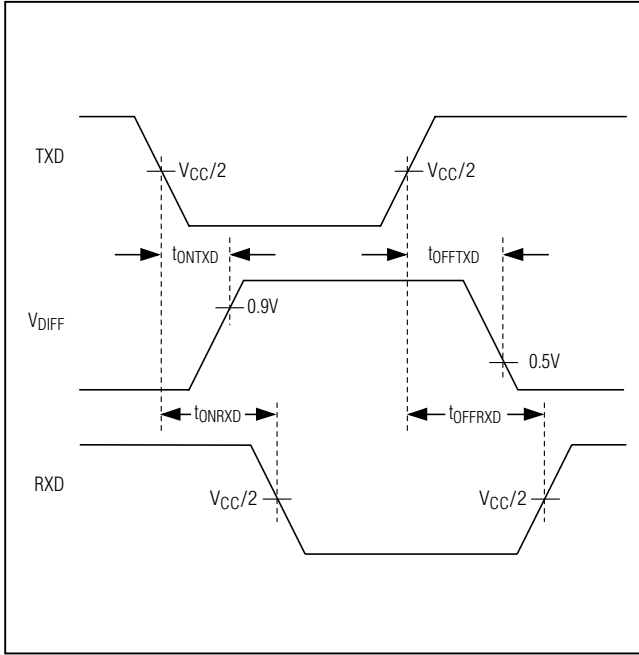

Figure 1. Timing Diagram

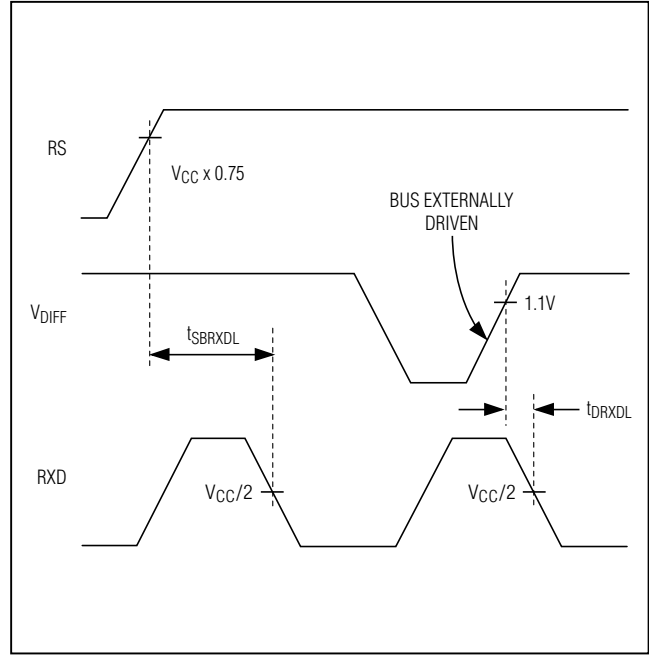

Figure 2. Timing Diagram for Standby Signal

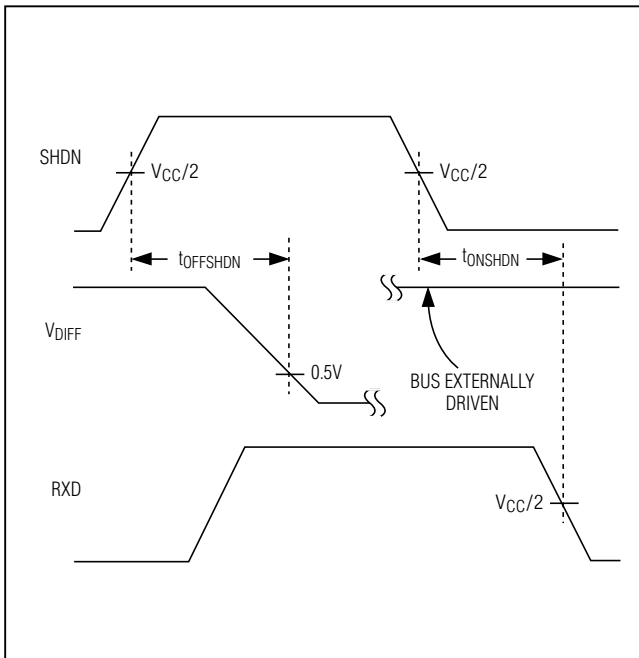

Figure 3. Timing Diagram for Shutdown Signal

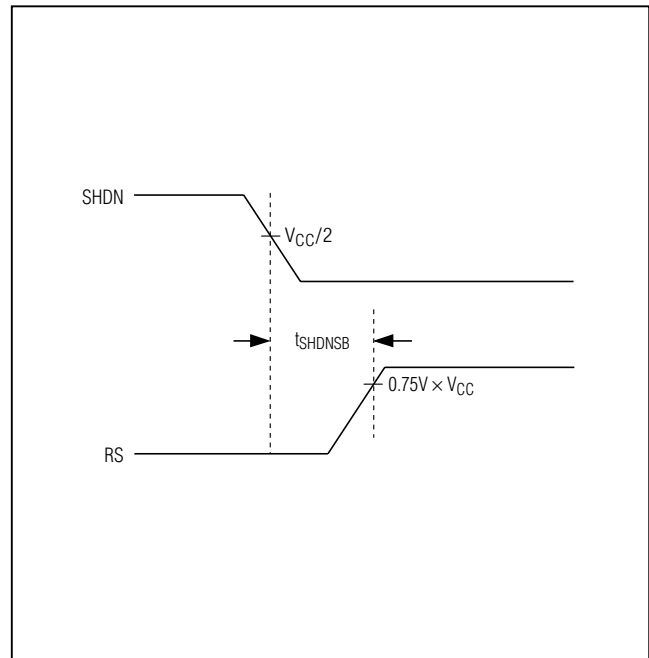

Figure 4. Timing Diagram for Shutdown-to-Standby Signal

MAX3051

+3.3V, 1Mbps, Low-Supply-Current CAN Transceiver

Typical Operating Characteristics

($V_{CC} = +3.3V$, $R_L = 60\Omega$, $C_L = 100pF$, $T_A = +25^\circ C$, unless otherwise specified.)

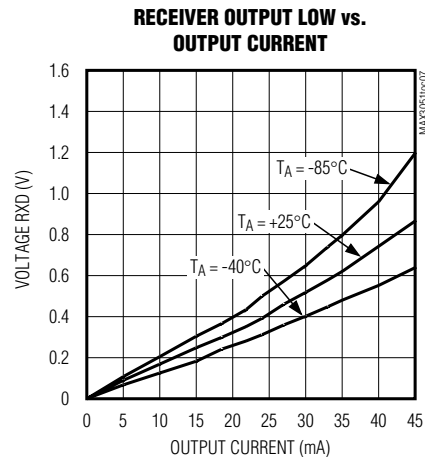
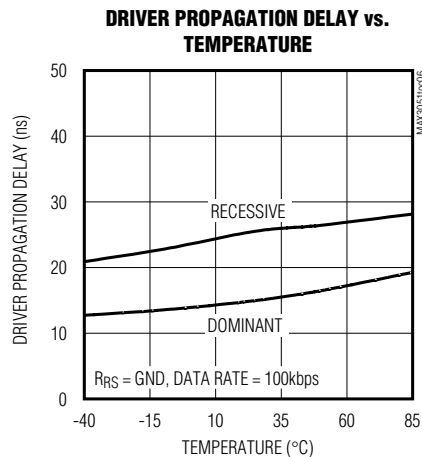
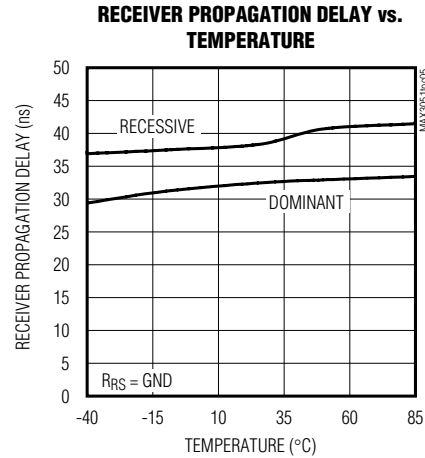
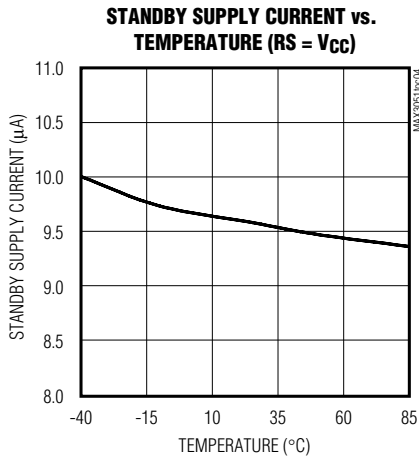
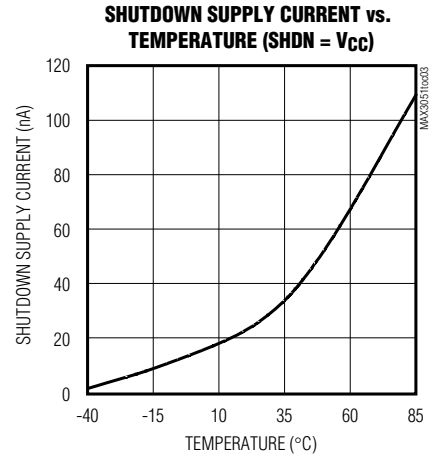
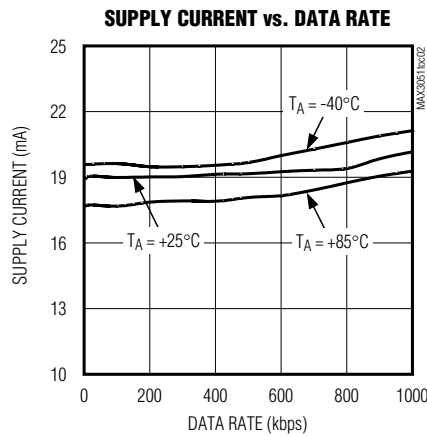
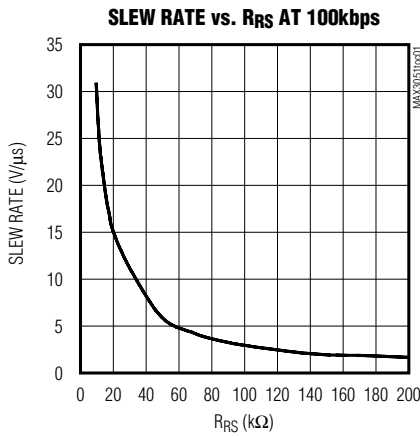

MAX3051

+3.3V, 1Mbps, Low-Supply-Current CAN Transceiver

Typical Operating Characteristics (continued)

(V_{CC} = +3.3V, R_L = 60Ω, C_L = 100pF, T_A = +25°C, unless otherwise specified.)

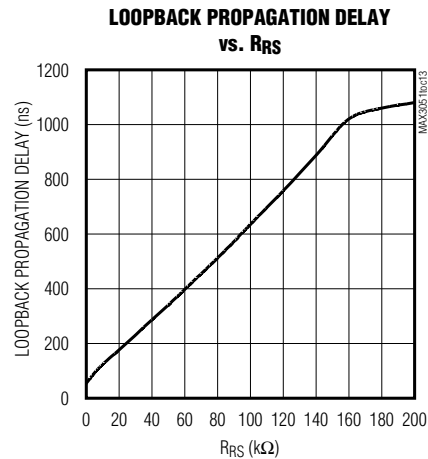
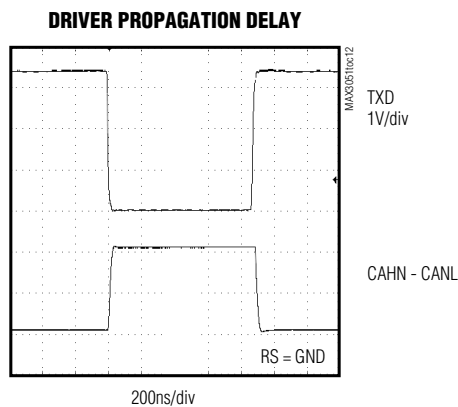
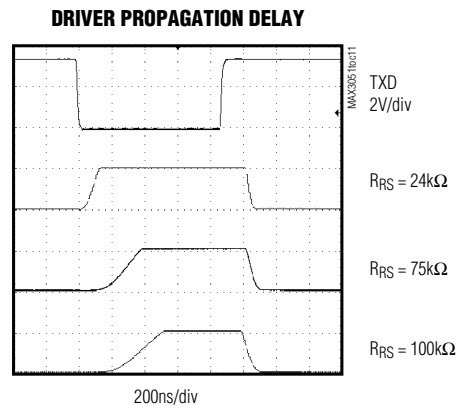
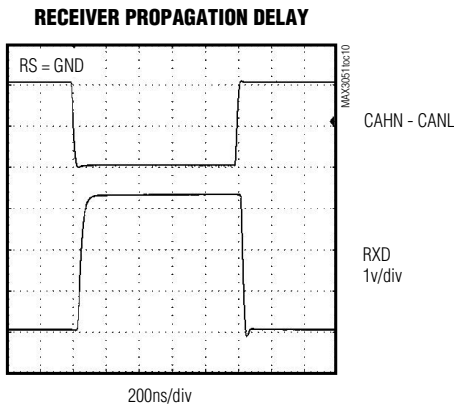
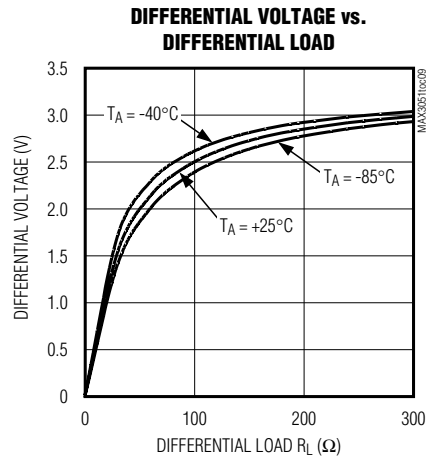
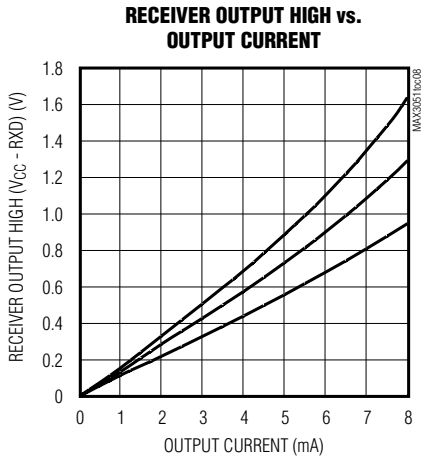

MAX3051

+3.3V, 1Mbps, Low-Supply-Current CAN Transceiver

Pin Description

PIN	NAME	FUNCTION
1	TXD	Transmit Data Input. TXD is a CMOS/TTL-compatible input from a CAN controller. TXD has an internal 75kΩ pullup resistor.
2	GND	Ground
3	VCC	Supply Voltage. Bypass VCC to GND with a 0.1μF capacitor.
4	RXD	Receive Data Output. RXD is a CMOS/TTL-compatible output.
5	SHDN	Shutdown Input, CMOS/TTL-Compatible. Drive SHDN high to put the MAX3051 in shutdown. SHDN has an internal 75kΩ pulldown resistor to GND.
6	CANL	CAN Bus Line Low
7	CANH	CAN Bus Line High
8	RS	Mode-Select Input. Drive RS low or connect to GND for high-speed operation. Connect a resistor between RS and GND to control output slope. Drive RS high to put into standby mode (see the <i>Mode Selection</i> section).

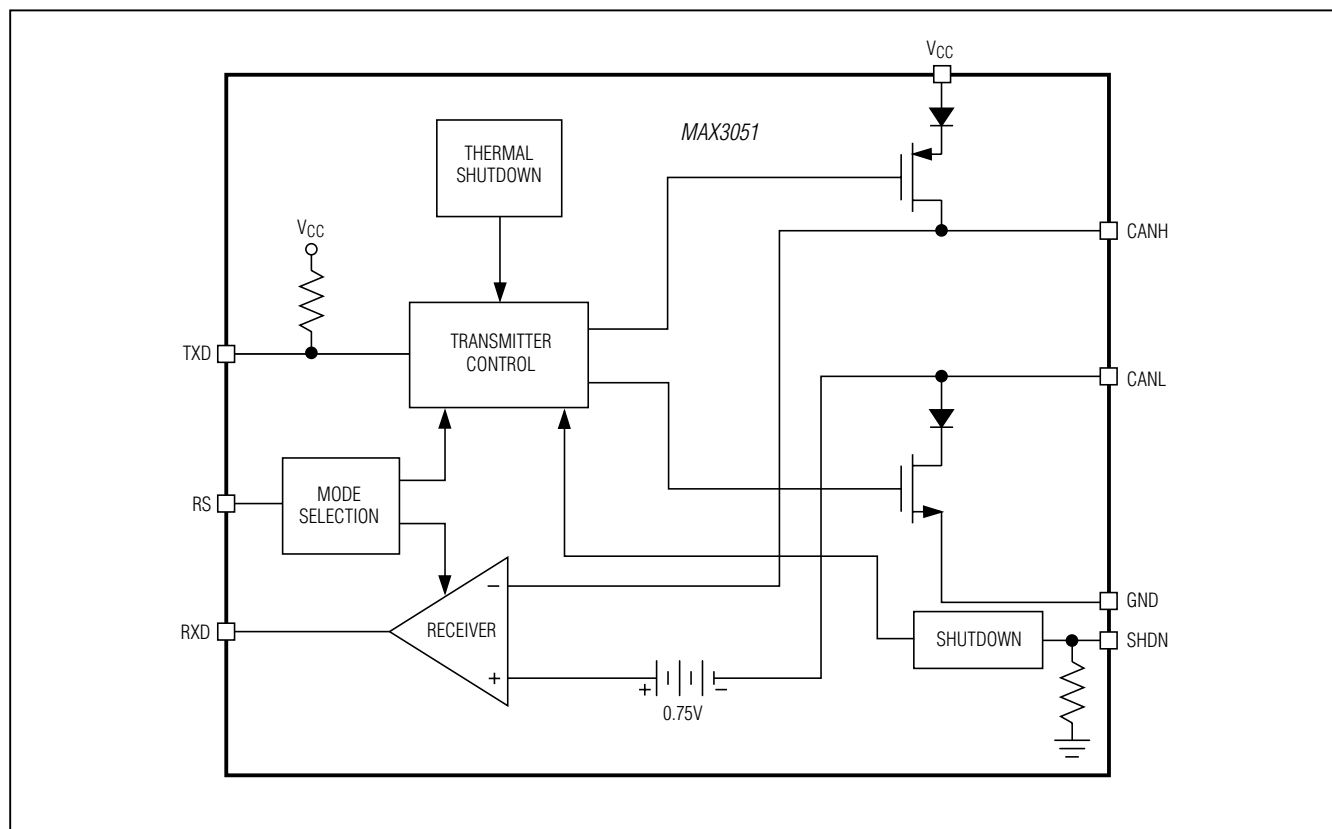

Figure 5. MAX3051 Functional Diagram

MAX3051

+3.3V, 1Mbps, Low-Supply-Current CAN Transceiver

Detailed Description

The MAX3051 interfaces between the CAN protocol controller and the physical wires of the bus lines in a CAN. It provides differential transmit capability to the bus and differential receive capability to the CAN controller. It is primarily intended for +3.3V single-supply applications that do not require the stringent fault protection specified by the automotive industry (ISO 11898)

The MAX3051 features four different modes of operation: high-speed, slope-control, standby, and shutdown mode. High-speed mode allows data rates up to 1Mbps. The slope-control mode can be used to program the slew rate of the transmitter for data rates of up to 500kbps. This reduces the effects of EMI, thus allowing the use of unshielded twisted or parallel cable. In standby mode, the transmitter is shut off and the receiver is pulled high, placing the MAX3051 in low-current mode. In shutdown mode, the transmitter and receiver are switched off.

The MAX3051 input common-mode range is from -7V to +12V, exceeding the ISO 11898 specification of -2V to +7V. These features, and the programmable slew-rate limiting, make the part ideal for nonautomotive, harsh environments.

The transceivers operate from a single +3.3V supply and draw 35µA of supply current in dominant state and 2µA in recessive state. In standby mode, supply current is reduced to 8µA. In shutdown mode, supply current is less than 1µA.

CANH and CANL are output short-circuit current limited and are protected against excessive power dissipation by thermal-shutdown circuitry that places the driver outputs into a high-impedance state.

Transmitter

The transmitter converts a single-ended input (TXD) from the CAN controller to differential outputs for the bus lines (CANH, CANL). The truth table for the transmitter and receiver is given in Table 1.

Table 1. Transmitter and Receiver Truth Table When Not Connected to the Bus

TXD	RS	SHDN	CANH	CANL	BUS STATE	RXD
Low	$V_{RS} < 0.75 \times V_{CC}$	Low	High	Low	Dominant	Low
High or float	$V_{RS} < 0.75 \times V_{CC}$	Low	5kΩ to 25kΩ to $V_{CC}/2$	5kΩ to 25kΩ to $V_{CC}/2$	Recessive	High
X	$V_{RS} > 0.75 \times V_{CC}$	Low	5kΩ to 25kΩ to GND	5kΩ to 25kΩ to GND	Recessive	High
X	X	High	Unconnected	Unconnected	Unconnected	High

Receiver

The receiver reads differential inputs from the bus lines (CANH, CANL) and transfers this data as a single-ended output (RXD) to the CAN controller. It consists of a comparator that senses the difference $V_{DIFF} = (CANH - CANL)$ with respect to an internal threshold of +0.75V. If this V_{DIFF} is greater than 0.75, a logic-low is present at RXD. If V_{DIFF} is less than 0.75V, a logic-high is present. The receiver always echoes the CAN BUS data.

The CANH and CANL common-mode range is -7V to +12V. RXD is logic-high when CANH and CANL are shorted or terminated and undriven.

Mode Selection

High-Speed Mode

Connect RS to ground to set the MAX3051 to high-speed mode. When operating in high-speed mode, the MAX3051 can achieve transmission rates of up to 1Mbps. In high-speed mode, use shielded twisted pair cable to avoid EMI problems.

Slope-Control Mode

Connect a resistor from RS to ground to select slope-control mode (Table 2). In slope-control mode, CANH and CANL slew rates are controlled by the resistor connected to the RS pin. Maximum transmission speeds are controlled by R_{RS} and range from 40kbps to 500kbps. Controlling the rise and fall slopes reduces EMI and allows the use of an unshielded twisted pair or a parallel pair of wires as bus lines. The equation for selecting the resistor value is given by:

$$R_{RS} (k\Omega) \approx 12000 / (\text{maximum speed in kbps})$$

See the Slew Rate vs. R_{RS} graph in the *Typical Operating Characteristics*.

Standby Mode

If a logic-high is applied to RS, the MAX3051 enters a low-current standby mode. In this mode, the transmitter

MAX3051

+3.3V, 1Mbps, Low-Supply-Current CAN Transceiver

is switched off and the receiver is switched to a low-current/low-speed state. If dominant bits are detected, RXD switches to low level. The microcontroller should react to this condition by switching the transceiver back to normal operation.

When the MAX3051 enters standby mode, RXD goes high for 4 μ s (max) regardless of the BUS state. However, after 4 μ s, RXD goes low only when the BUS is dominant, otherwise RXD remains high (when the BUS is recessive). For proper measurement of standby-to-receiver active time (t_{SBRXDL}), the BUS should be in dominant state (see Figure 2).

Shutdown

Drive SHDN high to enter shutdown mode. Connect SHDN to ground or leave unconnected for normal operation.

Thermal Shutdown

If the junction temperature exceeds +160°C, the device is switched off. The hysteresis is approximately 25°C, disabling thermal shutdown once the temperature drops below 135°C. In thermal shutdown, CANH and CANL go recessive and all IC functions are disabled.

Applications Information

Reduced EMI and Reflections

In slope-control mode, the CANH and CANL outputs are slew-rate limited, minimizing EMI and reducing reflections caused by improperly terminated cables.

In multidrop CAN applications, it is important to maintain a direct point-to-point wiring scheme. A single pair of wires should connect each element of the CAN bus, and the two ends of the bus should be terminated with 120 Ω resistors (Figure 6). A star configuration should never be used.

Any deviation from the point-to-point wiring scheme creates a stub. The high-speed edge of the CAN data on a stub can create reflections back down the bus. These reflections can cause data errors by eroding the noise margin of the system.

Although stubs are unavoidable in a multidrop system, care should be taken to keep these stubs as small as possible, especially in high-speed mode. In slope-control mode, the requirements are not as rigorous, but stub length should still be minimized.

Power Supply and Bypassing

The MAX3051 requires no special layout considerations beyond common practices. Bypass V_{CC} to GND with a 0.1 μ F ceramic capacitor mounted close to the IC with short lead lengths and wide trace widths.

Table 2. Mode Selection Truth Table

CONDITION FORCED AT PIN RS	MODE	RESULTING CURRENT AT RS
$V_{RS} < 0.3 \times V_{CC}$	High Speed	$ I_{RS} < 500\mu A$
$0.4 \times V_{CC} < V_{RS} < 0.6 \times V_{CC}$	Slope Control	$10\mu A < I_{RS} < 200\mu A$
$V_{RS} > 0.75 \times V_{CC}$	Standby	$ I_{RS} < 10\mu A$

MAX3051

+3.3V, 1Mbps, Low-Supply-Current CAN Transceiver

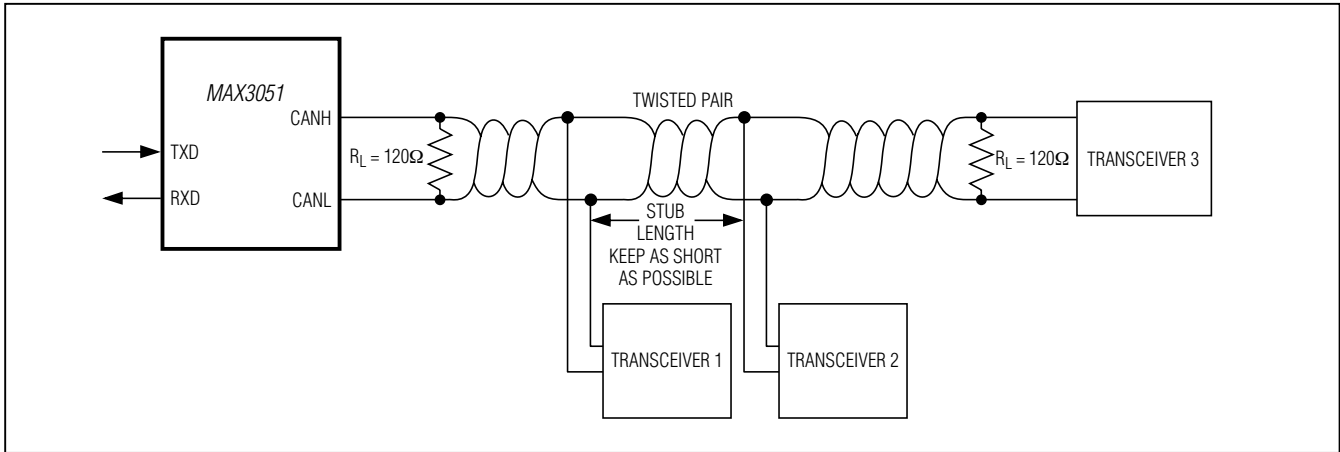
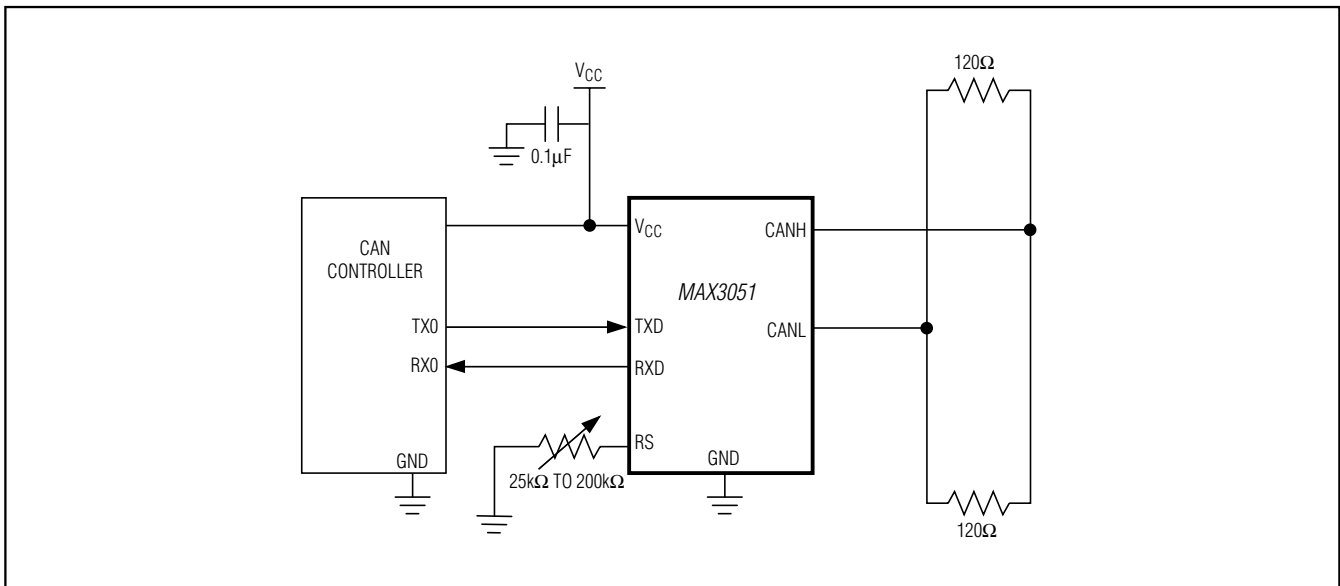

Figure 6. Multiple Receivers Connected to CAN Bus

Typical Operating Circuit



Chip Information

PROCESS: BiCMOS

Package Information

For the latest package outline information and land patterns (footprints), go to www.maximintegrated.com/packages. Note that a "+", "#", or "-" in the package code indicates RoHS status only. Package drawings may show a different suffix character, but the drawing pertains to the package regardless of RoHS status.

PACKAGE TYPE	PACKAGE CODE	OUTLINE NO.	LAND PATTERN NO.
8 SO	S8+4	21-0041	90-0096
8 SOT23	K8F+4	21-0078	90-0176

MAX3051

+3.3V, 1Mbps, Low-Supply-Current CAN Transceiver

Revision History

REVISION NUMBER	REVISION DATE	DESCRIPTION	PAGES CHANGED
2	10/12	Added lead-free part information to the data sheet	1-13



Maxim Integrated cannot assume responsibility for use of any circuitry other than circuitry entirely embodied in a Maxim Integrated product. No circuit patent licenses are implied. Maxim Integrated reserves the right to change the circuitry and specifications without notice at any time. The parametric values (min and max limits) shown in the Electrical Characteristics table are guaranteed. Other parametric values quoted in this data sheet are provided for guidance.