

LSIC1MO120E0080 1200 V N-channel, Enhancement-mode SiC MOSFET **HF** **RoHS** **Pb**

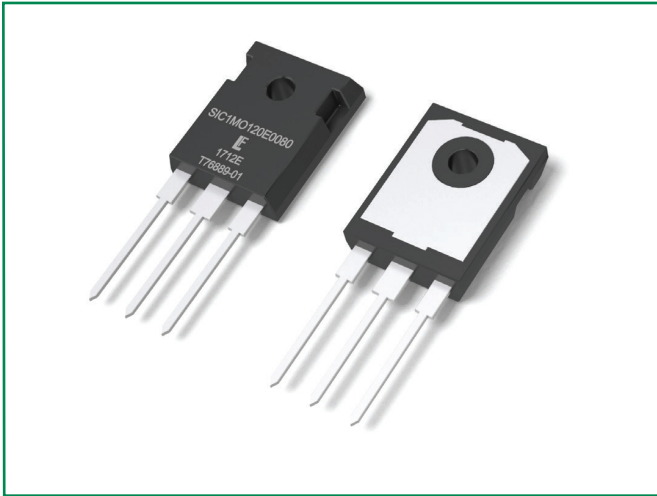

Product Summary

Characteristics	Value	Unit
V_{DS}	1200	V
Typical $R_{DS(ON)}$	80	mΩ
I_D ($T_C \leq 100\text{ }^\circ\text{C}$)	25	A

Circuit Diagram TO-247-3L

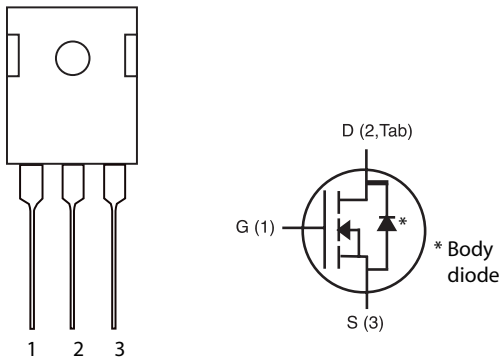

Features

- Optimized for high-frequency, high-efficiency applications
- Extremely low gate charge and output capacitance
- Low gate resistance for high-frequency switching
- Normally-off operation at all temperatures
- Ultra-low on-resistance

Environmental

- Littelfuse "RoHS" logo = **RoHS**
RoHS conform
- Littelfuse "HF" logo = **HF**
Halogen Free
- Littelfuse "Pb-free" logo = **Pb**
Pb-free lead plating

Applications

- High-frequency applications
- Solar Inverters
- Switch Mode Power Supplies
- UPS
- Motor Drives
- High Voltage DC/DC Converters
- Battery Chargers
- Induction Heating

Maximum Ratings

Characteristics	Symbol	Conditions	Value	Unit
Continuous Drain Current	I_D	$V_{GS} = 20\text{ V}, T_C = 25\text{ }^\circ\text{C}$	39	A
		$V_{GS} = 20\text{ V}, T_C = 100\text{ }^\circ\text{C}$	25	
Pulsed Drain Current ¹	$I_{D(\text{pulse})}$	$T_C = 25\text{ }^\circ\text{C}$	80	A
Power Dissipation	P_D	$T_C = 25\text{ }^\circ\text{C}, T_J = 150\text{ }^\circ\text{C}$	179	W
Operating Junction Temperature	T_J		-55 to 150	$^\circ\text{C}$
Gate-source Voltage	$V_{GS,MAX}$	Absolute maximum values	-6 to 22	V
	$V_{GS,OPTR}$	Transient, <1% duty cycle	-10 to 25	
	$V_{GS,OP}$	Recommended DC operating values	-5 to 20	
Storage Temperature	T_{STG}	-	-55 to 150	$^\circ\text{C}$
Lead Temperature for Soldering	T_{sold}	-	260	$^\circ\text{C}$
Mounting Torque	M_D	M3 or 6-32 screw	0.6	Nm
			5.3	in-lb

Footnote 1: Pulse width limited by $T_{J,max}$

Thermal Characteristics

Characteristics	Symbol	Value	Unit
Maximum Thermal Resistance, junction-to-case	$R_{th,Jc,max}$	0.7	$^\circ\text{C/W}$
Maximum Thermal Resistance, junction-to-ambient	$R_{th,JA,max}$	40	$^\circ\text{C/W}$

Electrical Characteristics ($T_J = 25\text{ }^\circ\text{C}$ unless otherwise specified)

Characteristics	Symbol	Conditions	Min	Typ	Max	Unit
Static Characteristics						
Drain-source Breakdown Voltage	$V_{(BR)DSS}$	$V_{GS} = 0\text{ V}, I_D = 250\text{ }\mu\text{A}$	1200	-	-	V
Zero Gate Voltage Drain Current	I_{DSS}	$V_{DS} = 1200\text{ V}, V_{GS} = 0\text{ V}$	-	1	100	μA
		$V_{DS} = 1200\text{ V}, V_{GS} = 0\text{ V}, T_J = 150\text{ }^\circ\text{C}$	-	2	-	
Gate Leakage Current	$I_{GSS,F}$	$V_{GS} = 20\text{ V}, V_{DS} = 0\text{ V}$	-	-	100	nA
	$I_{GSS,R}$	$V_{GS} = -10\text{ V}, V_{DS} = 0\text{ V}$	-	-	100	
Drain-source On-state Resistance	$R_{DS(ON)}$	$I_D = 20\text{ A}, V_{GS} = 20\text{ V}$	-	80	100	m Ω
		$I_D = 20\text{ A}, V_{GS} = 20\text{ V}, T_J = 150\text{ }^\circ\text{C}$	-	105	-	
Gate Threshold Voltage	$V_{GS(th)}$	$V_{DS} = V_{GS}, I_D = 10\text{ mA}$	1.8	2.8	4.0	V
		$V_{DS} = V_{GS}, I_D = 10\text{ mA}, T_J = 150\text{ }^\circ\text{C}$	-	1.9	-	
Gate Resistance	R_G	$f = 1\text{ MHz}, V_{AC} = 25\text{ mV}$	-	1.0	-	Ω

Electrical Characteristics ($T_J = 25\text{ }^\circ\text{C}$ unless otherwise specified)

Characteristics	Symbol	Conditions	Value			Unit
			Min	Typ	Max	
Dynamic Characteristics						
Turn-on Switching Energy	E_{ON}	$V_{DD} = 800\text{ V}, I_D = 20\text{ A},$ $V_{GS} = -5/+20\text{ V},$ $R_{G,ext} = 2\ \Omega, L = 1.4\text{ mH}$	-	270	-	μJ
Turn-off Switching Energy	E_{OFF}		-	60	-	
Total Per-cycle Switching Energy	E_{TS}		-	330	-	
Input Capacitance	C_{ISS}	$V_{DD} = 800\text{ V}, V_{GS} = 0\text{ V},$ $f = 1\text{ MHz}, V_{AC} = 25\text{ mV}$	-	1825	-	pF
Output Capacitance	C_{OSS}		-	75	-	
Reverse Transfer Capacitance	C_{RSS}		-	15	-	
C_{OSS} Stored Energy	E_{OSS}		-	25	-	
Total Gate Charge	Q_g	$V_{DD} = 800\text{ V}, I_D = 20\text{ A},$ $V_{GS} = -5/+20\text{ V}$	-	95	-	nC
Gate-source Charge	Q_{gs}		-	29	-	
Gate-drain Charge	Q_{gd}		-	39	-	
Turn-on Delay Time	$t_{d(on)}$	$V_{DD} = 800\text{ V}, V_{GS} = -5/+20\text{ V},$ $I_D = 20\text{ A}, R_{G,ext} = 2\ \Omega,$ $R_L = 40\ \Omega,$ Timing relative to V_{DS}	-	10	-	ns
Rise Time	t_r		-	10	-	
Turn-off Delay Time	$t_{d(off)}$		-	16	-	
Fall Time	t_f		-	6	-	

Reverse Diode Characteristics

Characteristics	Symbol	Conditions	Value			Unit
			Min	Typ	Max	
Diode Forward Voltage	V_{SD}	$I_S = 10\text{ A}, V_{GS} = 0\text{ V}$	-	3.8	-	V
		$I_S = 10\text{ A}, V_{GS} = 0\text{ V}, T_J = 150\text{ }^\circ\text{C}$	-	3.4	-	
Continuous Diode Forward Current	I_S	$V_{GS} = 0\text{ V}, T_C = 25\text{ }^\circ\text{C}$	-	-	35	A
Peak Diode Forward Current ¹	I_{SP}		-	-	85	
Reverse Recovery Time	t_{rr}	$V_{GS} = -5\text{ V}, I_S = 20\text{ A},$ $V_R = 800\text{ V},$ $di/dt = 5.3\text{ A/ns}$	-	25	-	ns
Reverse Recovery Charge	Q_{rr}		-	185	-	nC
Peak Reverse Recovery Current	I_{rrm}		-	16	-	A

Footnote 1: Pulse width limited by $T_{J,max}$

Figure 1: Maximum Power Dissipation ($T_j = 150^\circ\text{C}$)

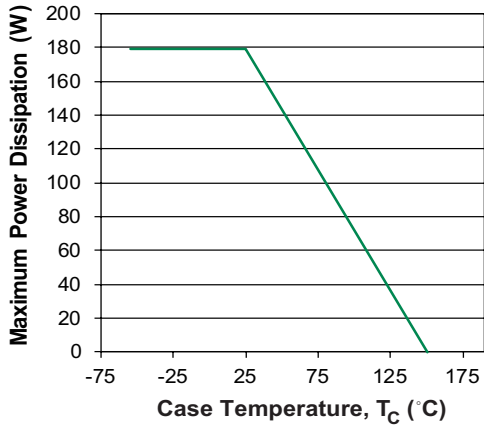

Figure 2: Transfer Characteristics ($V_{DS} = 10\text{V}$)

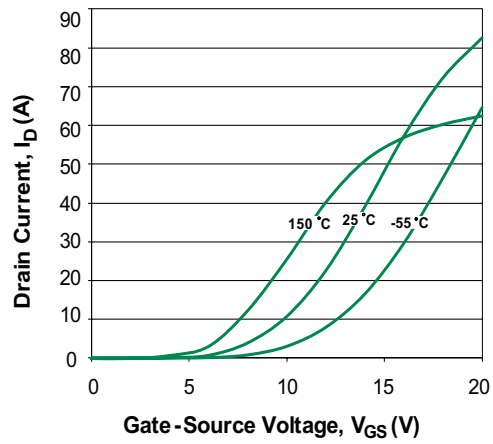

Figure 3: Output Characteristics ($T_j = 25^\circ\text{C}$)

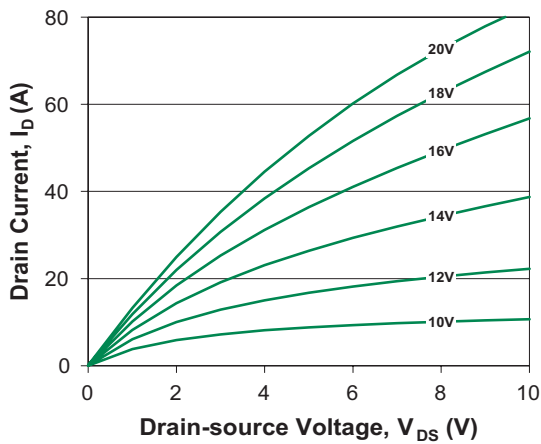

Figure 4: Output Characteristics ($T_j = 150^\circ\text{C}$)

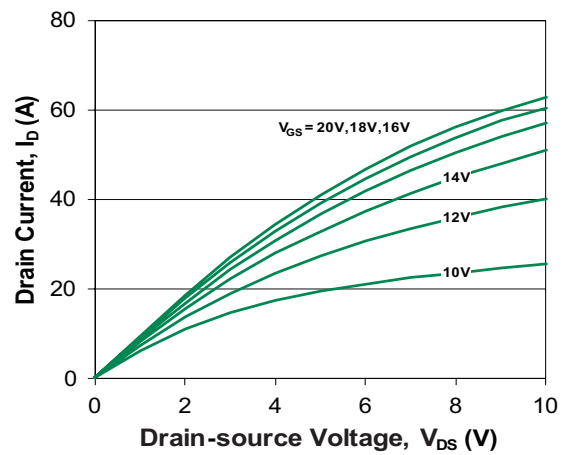

Figure 5: Output Characteristics ($T_j = -55^\circ\text{C}$)

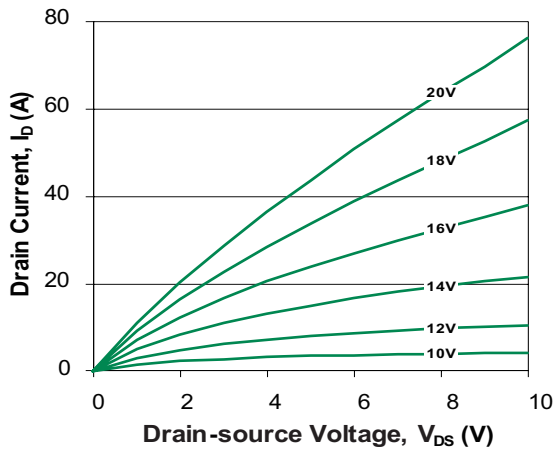

Figure 6: Reverse Conduction Characteristics ($T_j = 25^\circ\text{C}$)

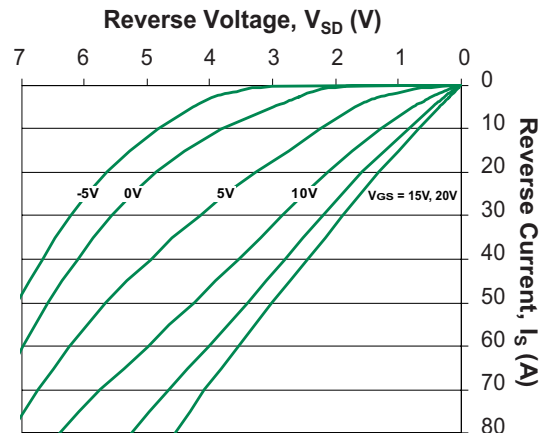

Figure 7: Reverse Conduction Characteristics ($T_J = 150\text{ }^\circ\text{C}$)

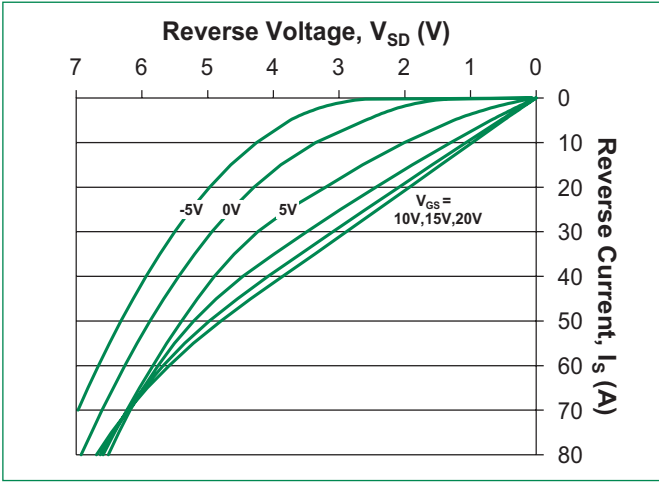

Figure 8: Reverse Conduction Characteristics ($T_J = -55\text{ }^\circ\text{C}$)

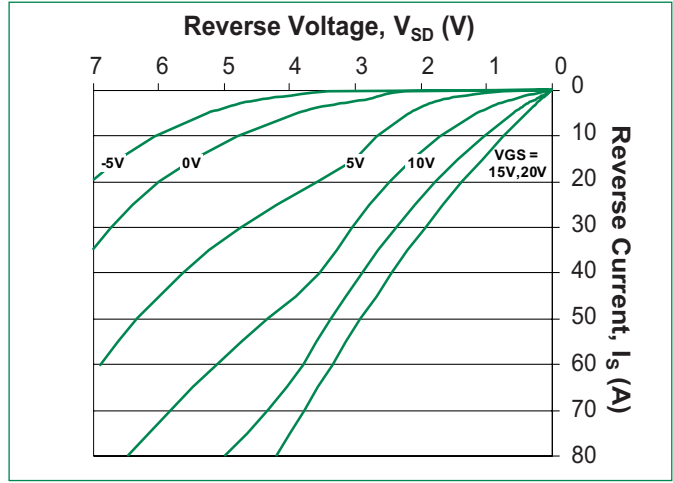

Figure 9: Transient Thermal Impedance

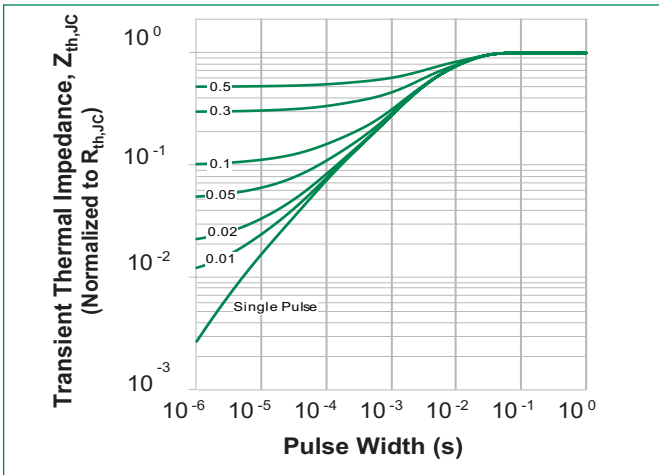

Figure 10: Safe Operating Area ($T_C = 25\text{ }^\circ\text{C}$)

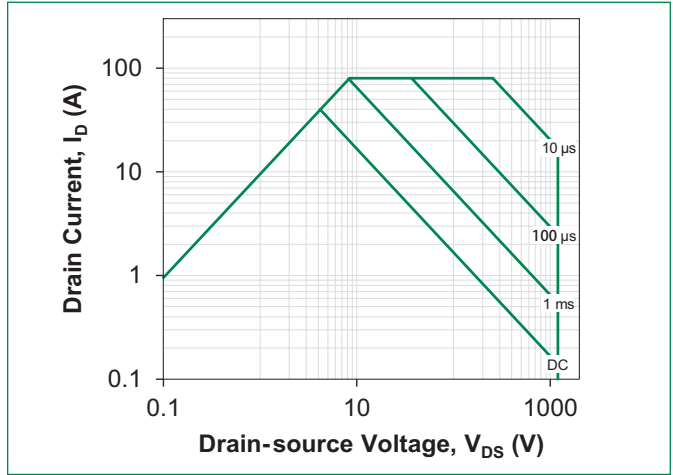

Figure 11: On-resistance vs. Drain Current

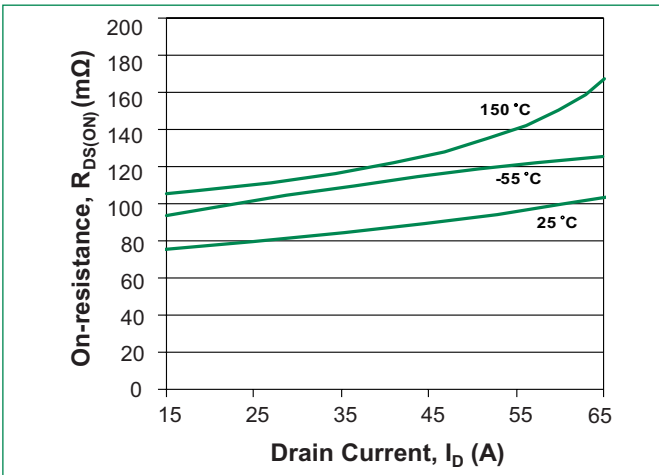

Figure 12: Normalized On-resistance

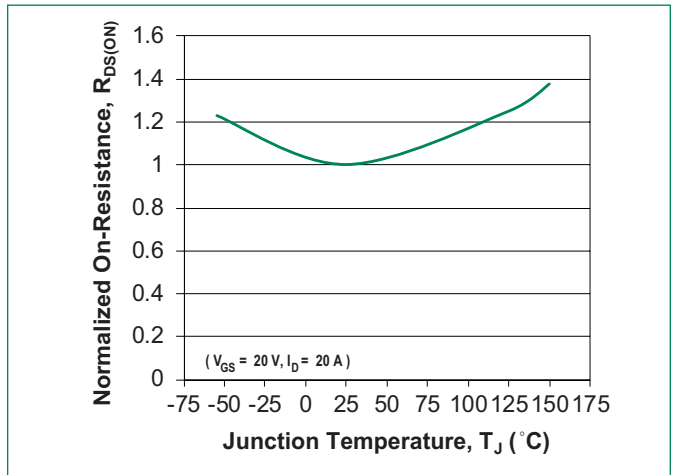

Figure 13: Threshold Voltage

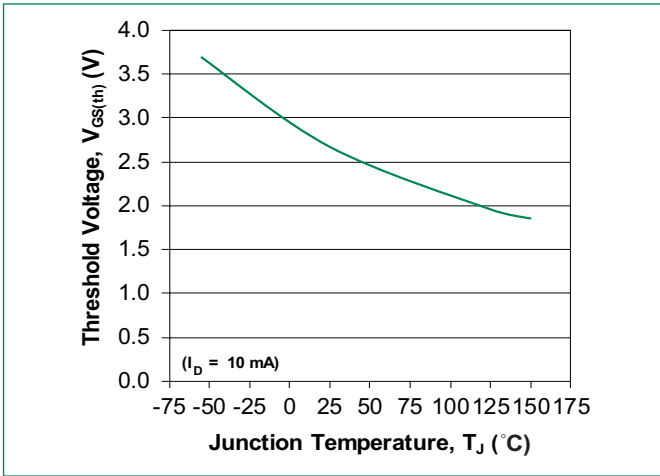

Figure 14: Drain-source Blocking Voltage

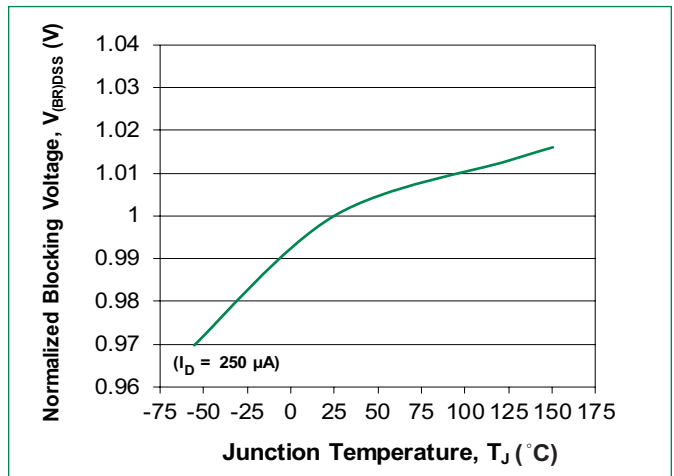

Figure 15: Junction Capacitances

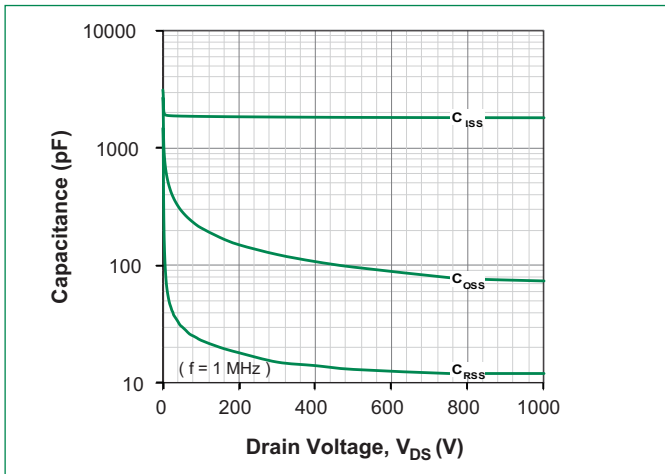

Figure 16: Junction Capacitances

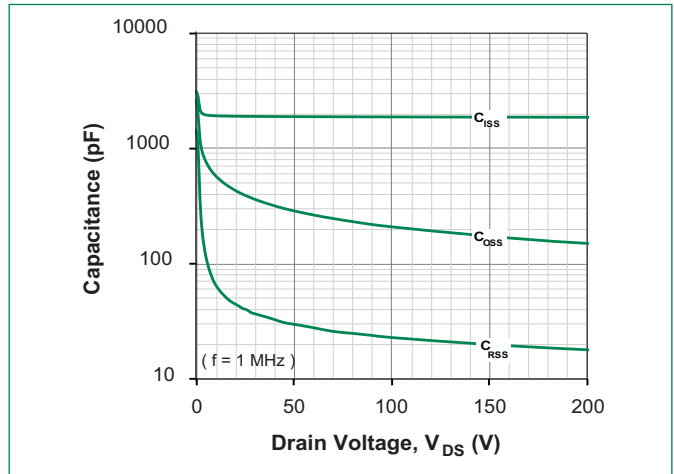

Figure 17: C_{oss} Stored Energy E_{oss}

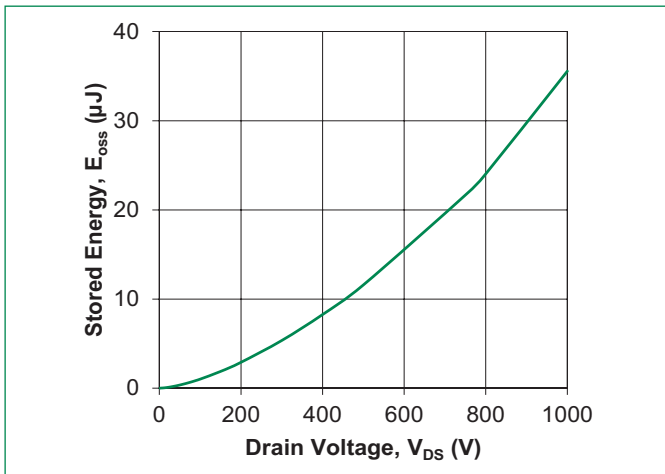

Figure 18: Gate Charge

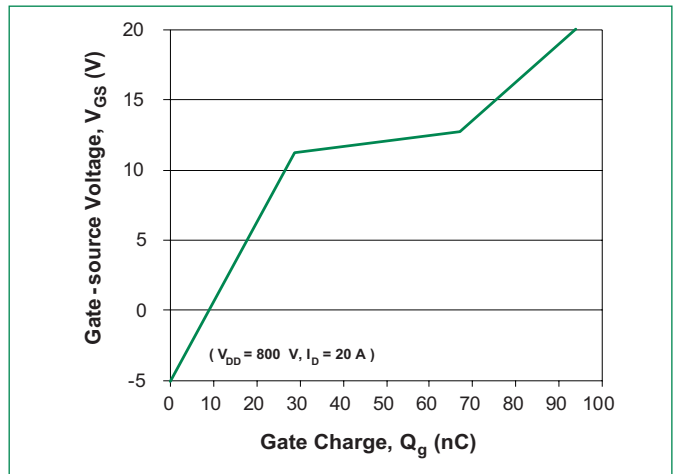
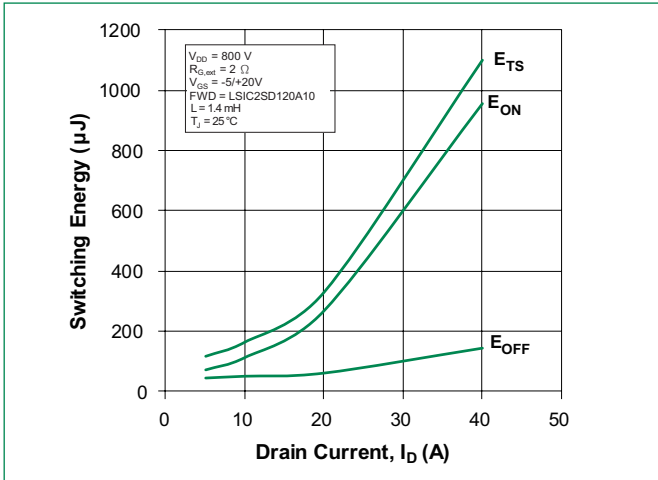
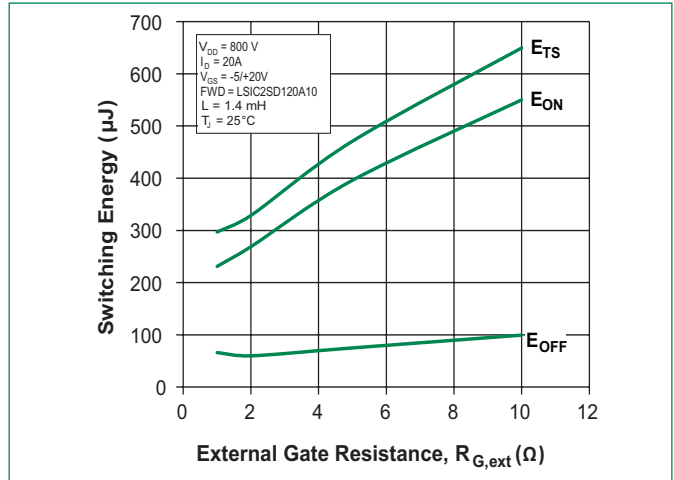
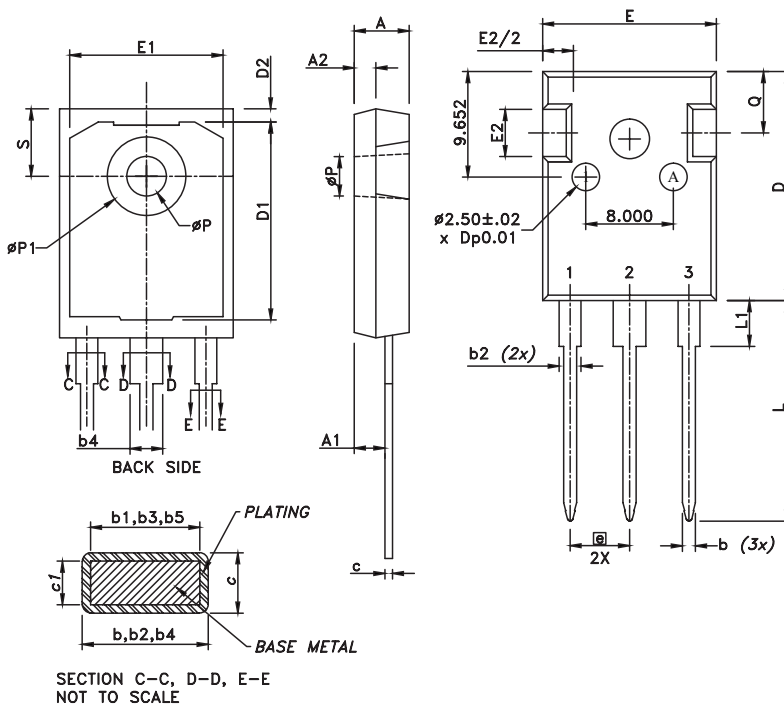
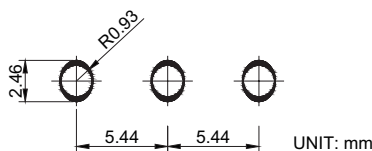

Figure 19: Switching Energy vs. Drain Current

Figure 20: Switching Energy vs. Gate Resistance

Package Dimensions TO-247-3L

Symbol	Millimeters		
	Min	Nom	Max
A	4.902	5.029	5.156
A1	2.253	2.380	2.507
A2	1.854	1.981	2.108
D	20.828	20.955	21.082
E	15.773	15.900	16.027
E2	4.191	4.318	4.445
E2/2	1.473	1.524	1.575
e	5.436		
L	20.066	20.193	20.320
L1	3.937	4.191	4.445
øP	3.556	3.067	3.658
Q	5.486	5.613	5.740
S	6.045	6.172	6.299
b	0.991	-	1.397
b1	0.991	1.199	1.346
b2	1.651	-	2.387
b3	1.651	1.999	2.336
b4	2.591	-	3.429
b5	2.591	3.000	3.378
c	0.381	0.635	0.889
c1	0.381	0.610	0.838
D1	17.399	17.526	17.653
D2	1.067	1.194	1.321
E1	13.894	14.021	14.148
øP1	7.061	7.188	7.315

Recommended Hole Pattern Layout

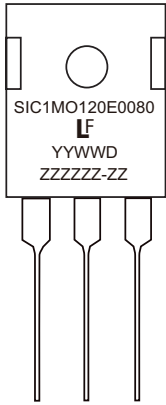
- Notes:
- Dimensions are in millimeters
 - Dimension D, E do not include mold flash. Mold flash shall not exceed 0.127 mm per side measured at outer most extreme of plastic body.
 - øP to have a maximum draft angle of 38.1 mm to the top of the part with a maximum hole diameter of 3.912 mm.

Part Numbering and Marking System



SIC = SiC
 1 = Gen1
 MO = MOSFET
 120 = Voltage Rating (1200 V)
 E = TO-247-3L
 0080 = $R_{DS(ON)}$ (80 mOhm)
 YY = Year
 WW = Week
 D = Special Code
 ZZZZZZ-ZZ = Lot Number

Packing Options

Part Number	Marking	Packing Mode	M.O.Q
LSIC1MO120E0080	SIC1MO120E0080	Tube	450

Packing Specification TO-247-3L

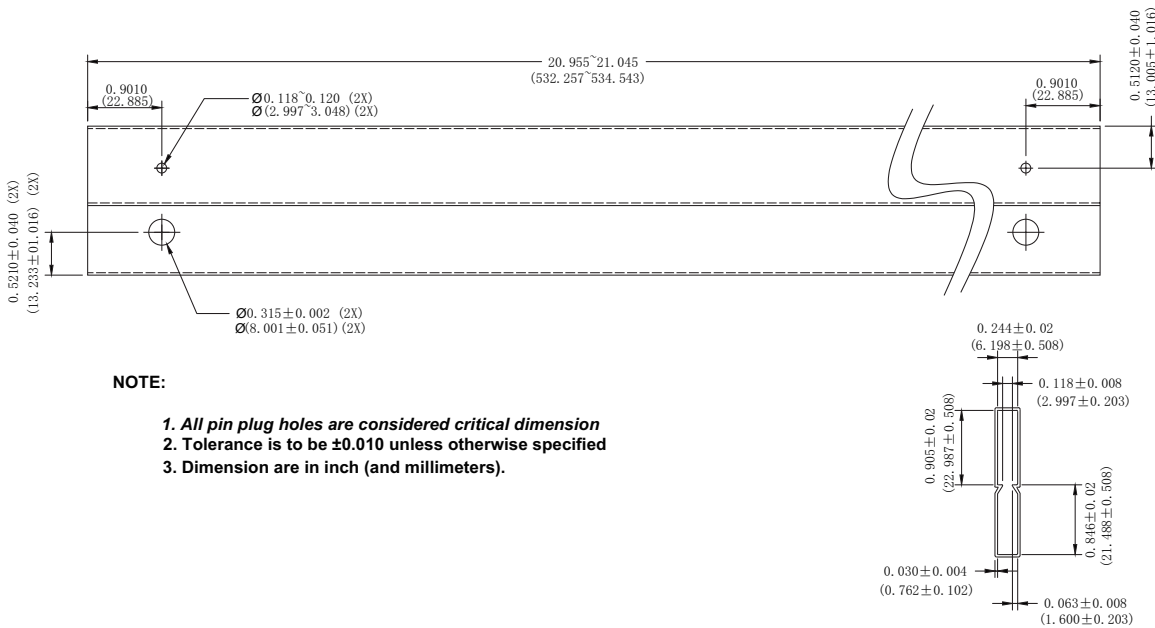

NOTE:

1. All pin plug holes are considered critical dimension
2. Tolerance is to be ± 0.010 unless otherwise specified
3. Dimension are in inch (and millimeters).

Disclaimer Notice - Littelfuse products are not designed for, and shall not be used for, any purpose (including, without limitation, automotive, military, aerospace, medical, life-saving, life-sustaining or nuclear facility applications, devices intended for surgical implant into the body, or any other application in which the failure or lack of desired operation of the product may result in personal injury, death, or property damage) other than those expressly set forth in applicable Littelfuse product documentation. Warranties granted by Littelfuse shall be deemed void for products used for any purpose not expressly set forth in applicable Littelfuse documentation. Littelfuse shall not be liable for any claims or damages arising out of products used in applications not expressly intended by Littelfuse as set forth in applicable Littelfuse documentation. The sale and use of Littelfuse products is subject to Littelfuse Terms and Conditions of Sale, unless otherwise agreed by Littelfuse. Information furnished is believed to be accurate and reliable. However, users should independently evaluate the suitability of and test each product selected for their own applications. Littelfuse products are not designed for, and may not be used in, all applications. Read complete Disclaimer Notice at www.littelfuse.com/disclaimer-electronics.