

VOLTAGE PROTECTION RELAY LP10-V



SERVICE MANUAL

The Voltage Protection Relay protects system from the faults occurring on voltage line. Relay protects against under voltage, over voltage, phase unbalance, phase failure, incorrect phase sequence and neutral disconnection faults. Front adjustment knobs are provided for easy selection of nominal voltage, system type, trip delay, fault trip point. Onsite 3P3W / 3P4W selection offers flexibility to user. The faults under voltage and over voltage can be disabled while other faults cannot be disabled. All faults are self resetting. Multiple LEDs indicate type of fault that helps for diagnosis purpose. Potential free relay contacts can be used for connection / disconnection of load or trigger alarm for annunciation purpose. Relay has Fail safe operation. Application in Motor protection, conveyor system and for process industry etc.

Installation:



Installation to be carried out by qualified person along with life protecting equipment to prevent hazardous shock. Isolate incoming supply before connection. Do not expose device to Rain, Dust environment. Keep at least 10-15 mm distance on both sides of device. Do not install near Vibrating environment. Do not install near Heat source. Install Fuses of 2 Amp in series with supply. Use Sealing provision to protect from unintentional adjustment.

Dimensions:

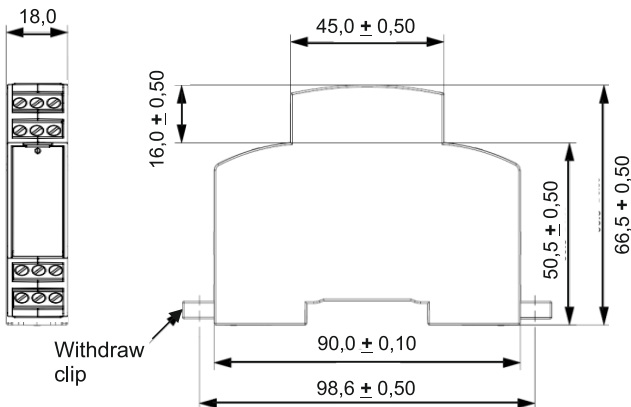

Mounting:

Device has 17,5 mm standard housing suitable for Din-rail or wall mount. To mount on DIN rail use standard 35 mm DIN rail (DIN50022). Wall mounting is to be done with the help of withdraw clips provided on bottom side of housing. Mounting and removing of device is demonstrated in below figures.

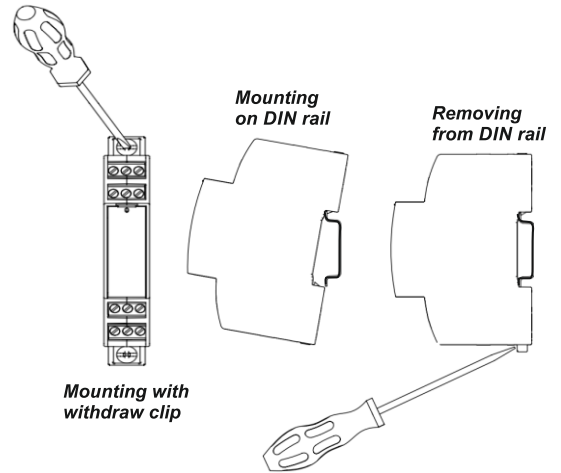

Terminals and Connector details:

Input connectors are marked by numbers 1, 2, 3, 4 and potential free relay contacts are marked as 11, 12, 14 for relay1 and 21, 22, 24 for relay2. Rated switchgear and fusing is required to prevent inrush. Wire of 2 sq. mm is recommended for Input connection. Use suitable screw driver for tightening so that sufficient force can be applied, take care while tightening because excess force may result in damage to inside circuitry. Control voltage is to be applied with fusing to the connector numbered as 14, 24. Refer diagrams for input connection.

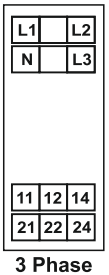

Connection diagram:

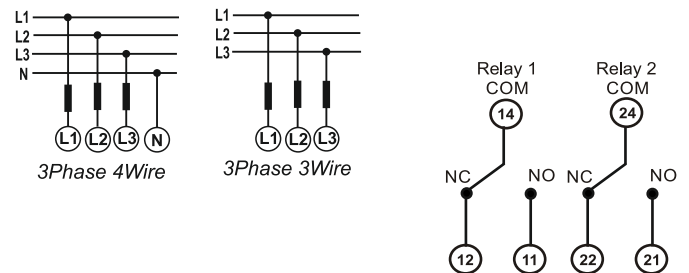

Parameter Settings:

Nominal Voltage Vn* (Variable - AC rms)	3 Phase : L : 110-240 VLL / 63-138 VLN : M : 381-388-415 VLL / 220-230-240 VLN : H : 415-440-480 VLL / 240-254-277 VLN
Under Voltage Trip point	75-95% (Variable)
Over Voltage Trip point	105-125% (Variable)
Voltage Unbalance Trip point	20% (Fixed)
Phase Failure Trip point	70 % (Fixed)
Hysteresis value	3% (Fixed) of Trip point 3% (Fixed) of Vn for Unbalance
Trip delay	0-10 seconds variable for Undervoltage, Over voltage, Unbalance. Instant tripping for Phase reversal, Neutral fail and Phase fail conditions
Reset Delay	1 second (Fixed)
Power On Delay	Approx. 3 seconds (Fixed)

*Note : For 3P3W system, the tripping is based on VLL value.
For 3P4W the tripping is based on VLN value.

Technical Specifications:

Input Voltage

Nominal Input Voltage As given above in **Parameter Settings**
 Max Continuous Input Voltage 127% of nominal value
 Nominal Frequency 50 / 60 Hz
 Input Voltage Burden Per phase < 2 VA approx.
 Input Voltage Burden Three phase < 4 VA approx.
 Operating Voltage Range 70...125% of nominal value

Operating reference condition

Reference Condition 23°C +/- 2°C
 Input waveform Sinusoidal (distortion factor 0.005)
 Input Frequency 50 / 60 Hz ± 2%

Accuracy

Tripping Accuracy ± 3% of Nominal Value
 ± 0.8 sec for Trip delay

Response Time

< 200 msec

Applicable Standards

Safety IEC 61010-1-2010
 IP for water & dust IEC60529
 Pollution degree 2
 Installation category CAT III

Environmental

High Voltage Test 2.2 kV AC 50Hz for 1 min. between all Electrical circuits.
 Operating temperature -10 to +55°C
 Storage temperature -25 to +70°C
 Relative humidity 0...90% non condensing
 Shock 15g in 3 planes
 Vibration 10...55 Hz, 0.15mm amplitude
 Enclosure Flame retardant, IP20 (front face only)

Relay Contacts

Types of output 1CO, 1CO+1CO
 Relay configuration Energised (relay is ON in healthy condition and relay is OFF in fault condition)

Contact Ratings 5A/250VAC/30VDC (resistive load)
 Mechanical Endurance 1x10⁷ OPS
 Electrical Endurance 1x10⁵ OPS

Mechanical Attributes

Weight 80g Approx.
 Dimensions 18 x 90 x 66 mm

Indication Table:

Each LED has two states to indicate type of fault as explained in table below.

LED Indication	Continuous ON	Blinking
P-ON	Power ON	Incorrect Phase Sequence
UV/PF	Undervoltage	Phase Fail
OV	Overvoltage	-----
UB/NF	Unbalance voltage	Neutral Fail

Adjustments:

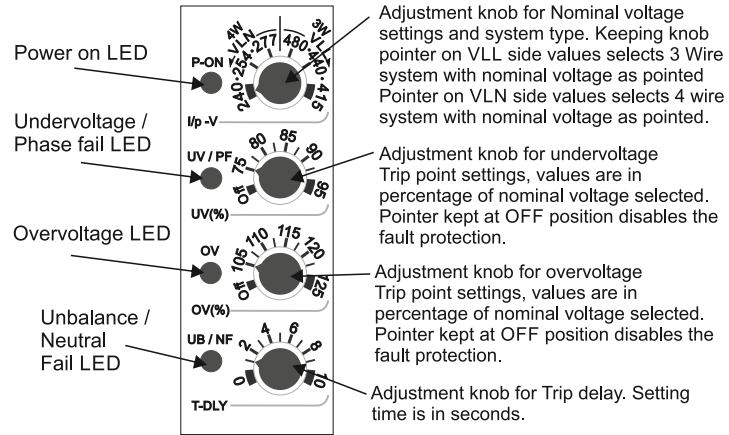

Tripping Diagrams:

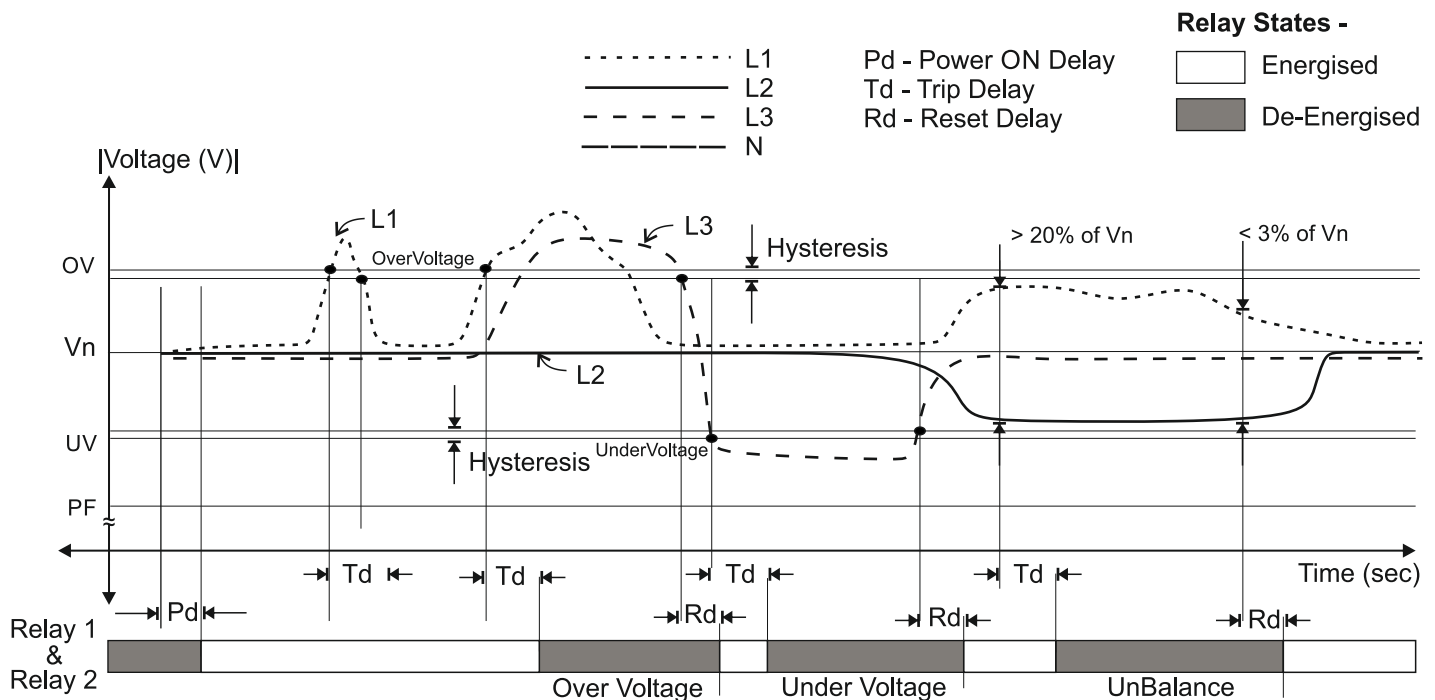

Figure 1 : OV, UV & UB Tripping functionality for 3 Phase System with default Energised Relay

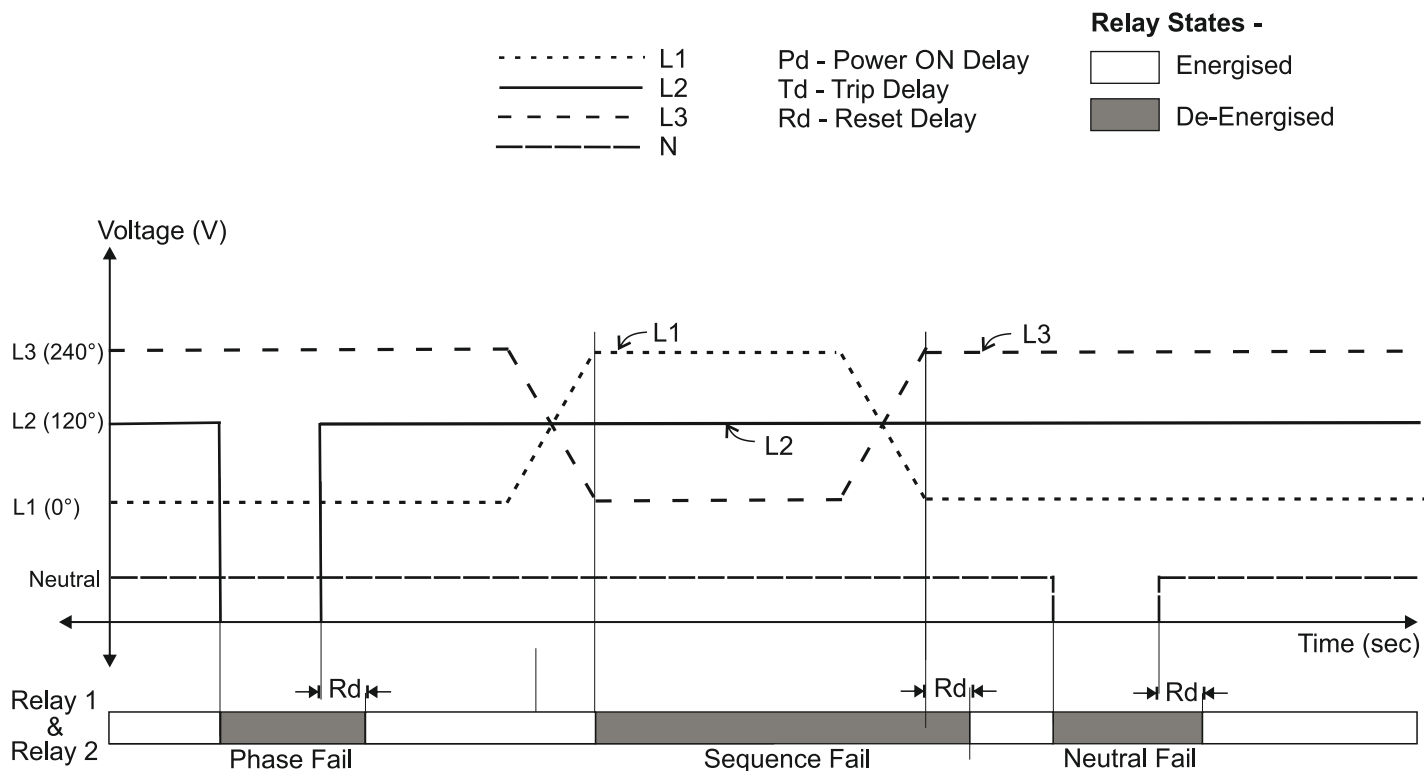

Figure 2 : PF, SEQ. FAIL & NF Tripping functionality for 3 Phase System with default Energised Relay



LUMEL S.A.

ul. Słubicka 4, 65-127 Zielona Góra, Poland
 tel.: +48 68 45 75 100, fax +48 68 45 75 508
 www.lumel.com.pl

Technical support:

tel.: (+48 68) 45 75 143, 45 75 141, 45 75 144, 45 75 140
 e-mail: export@lumel.com.pl

Export department:

tel.: (+48 68) 45 75 130, 45 75 131, 45 75 132
 e-mail: export@lumel.com.pl

Calibration & Attestation:

e-mail: laboratorium@lumel.com.pl