



LGE3M60065Q

Silicon Carbide Power MOSFET



$V_{DS} = 650\text{ V}$ $I_D@25^\circ\text{C} = 51\text{ A}$ $R_{DS(ON)} = 59\text{ m}\Omega$

Features

- High Blocking Voltage
- High Frequency Operation
- Low on-resistance
- Fast intrinsic diode with low reverse recovery

Benefits

- Higher System Efficiency
- Parallel Device Convenience without thermal runaway
- High Temperature Application
- Hard Switching & Higher Reliability
-

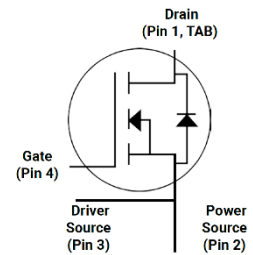
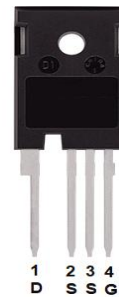

TO-247-4L
Pin definition

Applications

- Motor Drives
- Solar / Wind Inverters
- Onboard EV Charger
- AC/DC converters
- DC/DC converters
- Uninterruptable power supplies

Maximum Ratings ($T_C=25^\circ\text{C}$ unless otherwise specified)

Parameter	Symbol	Test conditions	Value	Unit
Drain - Source Voltage	V_{DSmax}	$V_{GS}=0\text{V}, I_D=100\mu\text{A}$	650	V
Gate - Source Voltage (dynamic)	V_{GSmax}	AC ($f>1\text{ Hz}$)	-8 / +23	V
Gate - Source Voltage (static)	V_{GSop}	static	-4 / +18	V
Continuous Drain Current	I_D	$V_{GS} = 18\text{V}, T_C=25^\circ\text{C}$ $V_{GS} = 18\text{V}, T_C=100^\circ\text{C}$	51 36	A
Pulsed Drain Current	$I_{D(pulse)}$	$T_C=25^\circ\text{C}$	97	A
Short Circuit Capability	t_{SC}	$V_{DD}=400\text{V}, V_{GS}=18\text{V}$	9	μS
Short Circuit Capability	I_{DS}	$V_{DD}=400\text{V}, V_{GS}=18\text{V}$	300	A
Total power dissipation	P_D	$T_C=25^\circ\text{C}$	208	W
Operating Junction Temperature	T_J		-55 to 175	$^\circ\text{C}$
Storage Temperature	T_{STG}		-55 to 175	$^\circ\text{C}$

Stresses exceeding those listed in the Maximum Ratings table may damage the device. If any of these limits are exceeded, device functionality should not be assumed, damage may occur and reliability may be affected.



Electrical Characteristics (T_C=25°C unless otherwise specified)

Parameter	Symbol	Test conditions	Min	Typ	Max	Unit
Drain-Source Breakdown Voltage	V _{(BR)DSS}	V _{GS} = 0V, I _D = 100μA	650			V
Gate Threshold Voltage	V _{GS(th)}	V _{DS} = V _{GS} , I _D = 5mA	1.9	2.7	3.9	V
		V _{DS} = V _{GS} , I _D = 5mA, T _J = 150°C		2.0		V
		V _{DS} = V _{GS} , I _D = 5mA, T _J = 175°C		1.9		V
Zero Gate Voltage Drain Current	I _{DSS}	V _{DS} = 650V, V _{GS} = 0V	0	1	100	μA
Gate-Source Leakage Current	I _{GSS}	V _{GS} = 18V, V _{DS} = 0V	0	10	200	nA
Gate-Source Leakage Current	I _{GSS}	V _{GS} = -4V, V _{DS} = 0V	-200	-10	0	nA
Drain-Source On-State Resistance	R _{DS(on)}	V _{GS} = 16V, I _D = 15 A		68		mΩ
		V _{GS} = 16V, I _D = 15 A, T _J = 150°C		68		
		V _{GS} = 16V, I _D = 15 A, T _J = 175°C		72		
		V _{GS} = 18V, I _D = 20 A		59	75	
		V _{GS} = 18V, I _D = 20 A, T _J = 150°C		64		
		V _{GS} = 18V, I _D = 20 A, T _J = 175°C		68		
Transconductance	g _{fs}	V _{DS} = 20V, I _D = 20 A,		11		S
		V _{DS} = 20V, I _D = 20 A, T _J = 150°C		10.7		
		V _{DS} = 20V, I _D = 20 A, T _J = 175°C		10.5		
Input capacitance	C _{iSS}	V _{DS} = 400V, V _{GS} = 0V f = 1MHz		1600		pF
Output capacitance	C _{oss}			145		
Reverse transfer capacitance	C _{rSS}			11		
C _{oss} Stored Energy	E _{oss}			14		
Total gate charge	Q _g	V _{DS} = 400V, V _{GS} = -4V / 18V I _D = 20 A,		78		nC
Gate-source charge	Q _{gs}			21		
Gate-drain charge	Q _{gd}			34		
Internal gate input resistance	R _{g(int)}	f = 1MHz, I _D = 0A		2.1		Ω
Turn-On Switching Energy	E _{ON}	V _{DS} = 400 V, V _{GS} = -4V/18V, I _D = 20A, R _{G(ext)} = 2Ω, L = 200μH		15		μJ
Turn-Off Switching Energy	E _{OFF}			12		
Turn-On Delay Time	t _{d(on)}			10		ns
Rise Time	t _r			8		
Turn-Off Delay Time	t _{d(off)}			19		
Fall Time	t _f			5		
Avalanche Capability	E _{AS}	V _{DD} = 100V, V _{GS} = 20V, L = 1mH		200		mJ
Avalanche Capability	I _{AV}			20		A



Reverse Diode Characteristics ($T_C=25^\circ\text{C}$ unless otherwise specified)

Parameter	Symbol	Condition	Min	Typ	Max	Unit
Diode Forward Voltage	V_{SD}	$V_{GS} = -4\text{V}, I_{SD} = 10\text{A},$		3.9		V
		$V_{GS} = -4\text{V}, I_{SD} = 10\text{A},$ $T_J = 150^\circ\text{C}$		3.5		
		$V_{GS} = -4\text{V}, I_{SD} = 10\text{A},$ $T_J = 175^\circ\text{C}$		3.4		
Continuous Diode Forward Current	I_S	$V_{GS} = -4\text{V}$		35		A
Reverse Recovery time	t_{rr}	$V_{GS} = -4\text{V}, I_{SD} = 20\text{A},$ $V_R = 400\text{V}, \text{dif}/\text{dt} = 2000 \text{ A}/\mu\text{s}$		20		ns
Reverse Recovery Charge	Q_{rr}			160		nC
Peak Reverse Recovery Current	I_{rrm}			14		A

Thermal Characteristics

Parameter	Symbol	Condition	Min	Typ	Max	Unit
Thermal Resistance (per device)	$R_{th(j-c)}$	junction-case		0.6	0.72	$^\circ\text{C}/\text{W}$



Typical Performance

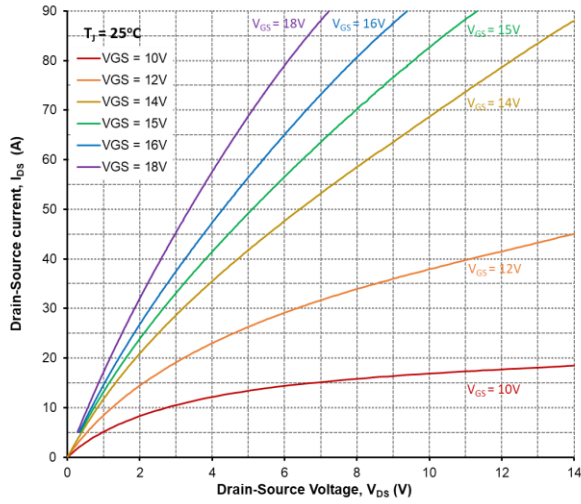

Figure 1. Output Characteristics, $T_J = 25^\circ\text{C}$

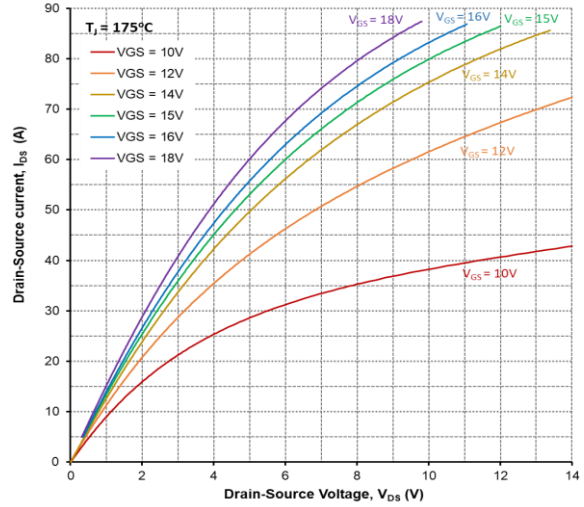

Figure 2. Output Characteristics, $T_J = 175^\circ\text{C}$

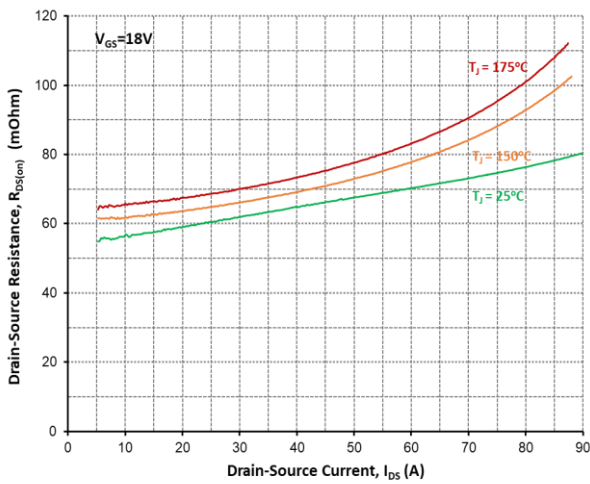

Figure 3. On-Resistance vs. Drain Current For Various Temperatures

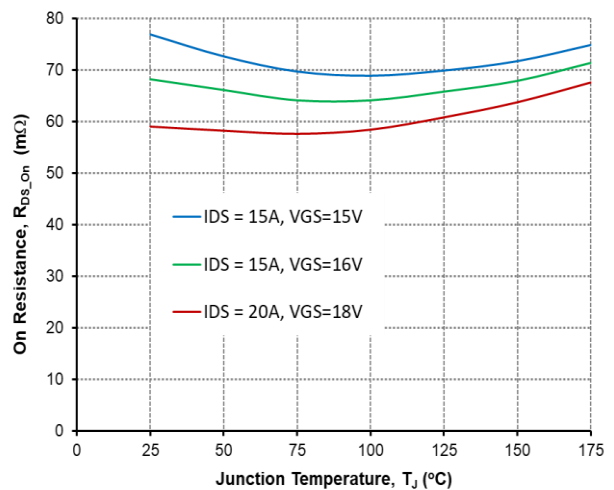

Figure 4. On-Resistance vs. Temperature

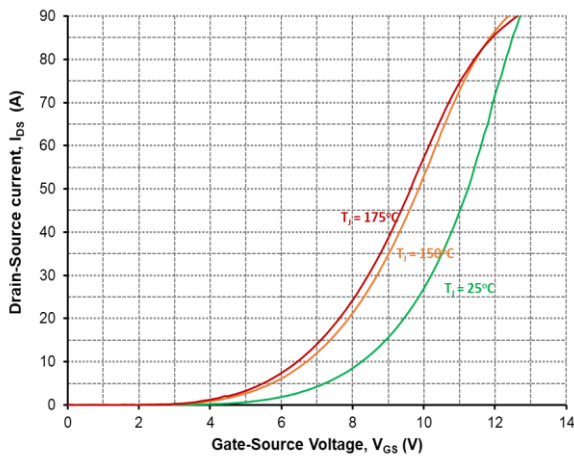

Figure 5. Transfer Characteristic For Various Junction Temperatures

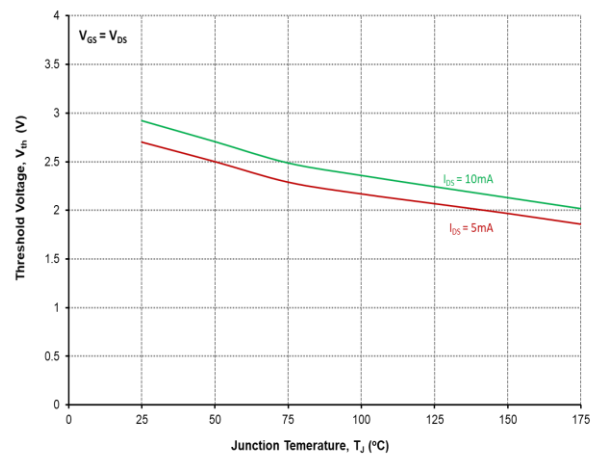

Figure 6. Threshold Voltage vs. Temperature



Typical Performance

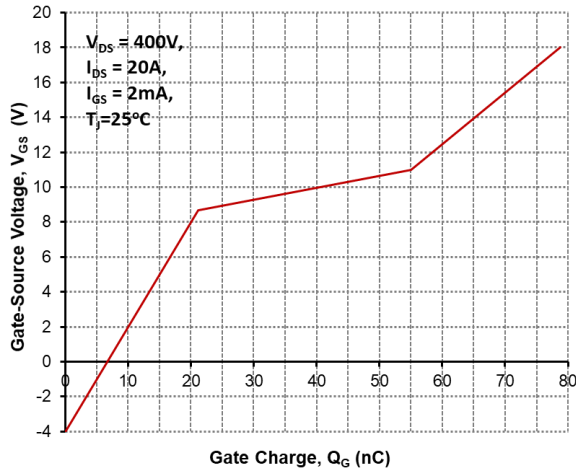

Figure 7. Gate Charge Characteristics

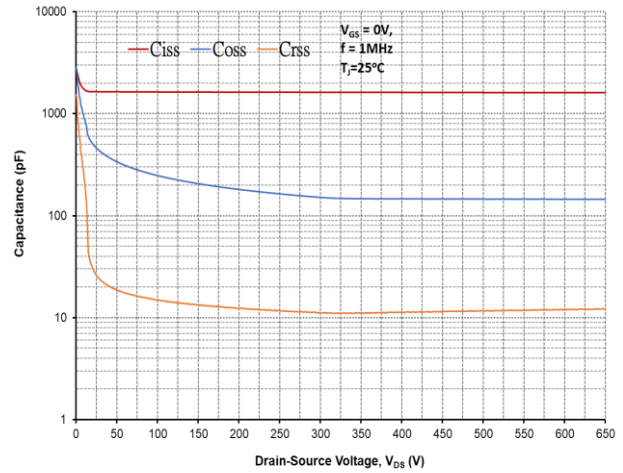

Figure 8. Capacitances vs. Drain-Source Voltage (0-650V)

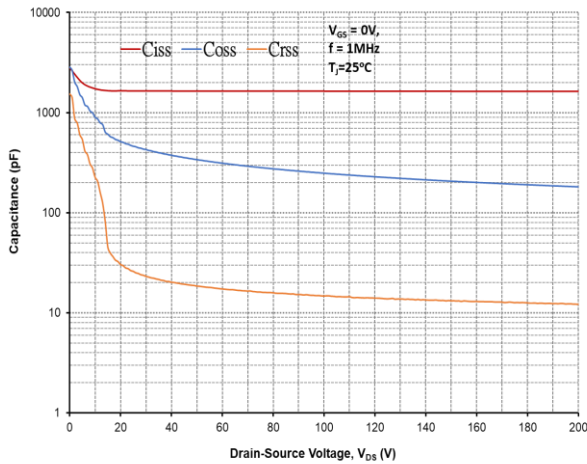

Figure 9. Capacitances vs. Drain-Source Voltage (0-200V)

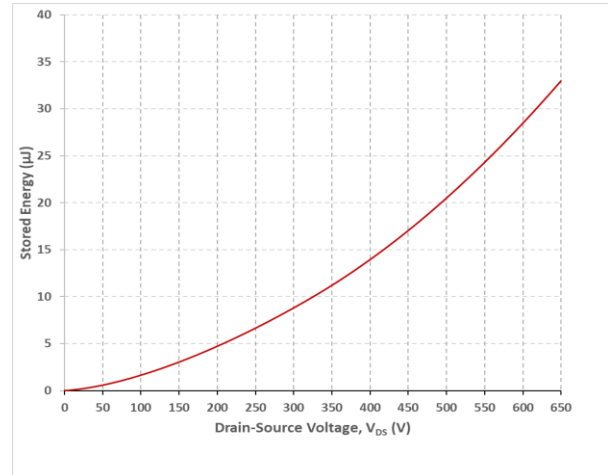

Figure 10. Output Capacitor Stored Energy

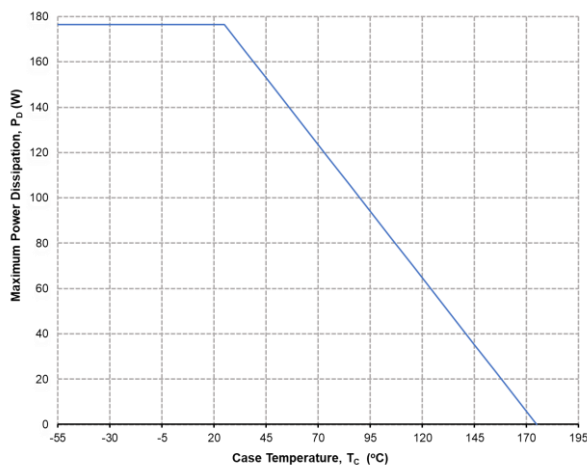

Figure 11. Maximum Power Dissipation Derating vs. Case Temperature

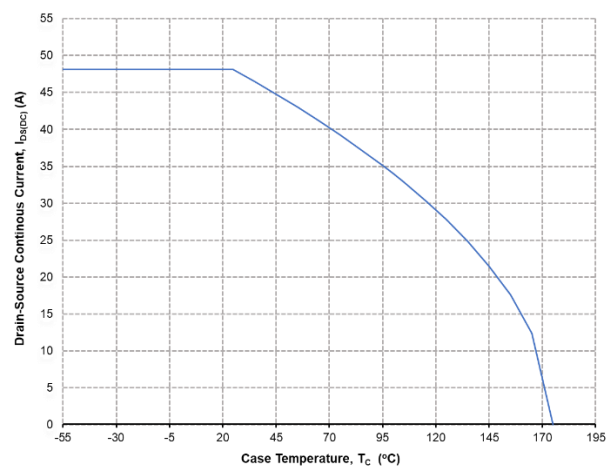

Figure 12. Continuous Drain Current Derating vs. Case Temperature



Typical Performance

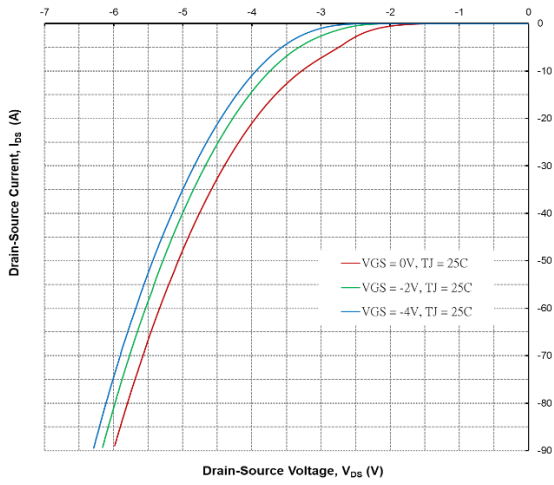

Figure 13. Body Diode Characteristics @ 25°C

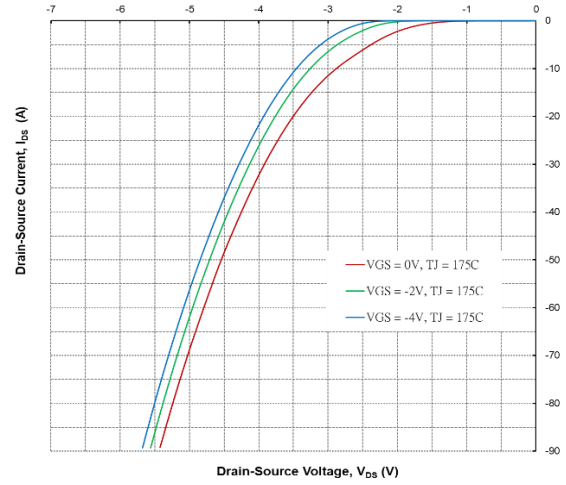

Figure 14. Body Diode Characteristics @ 175°C

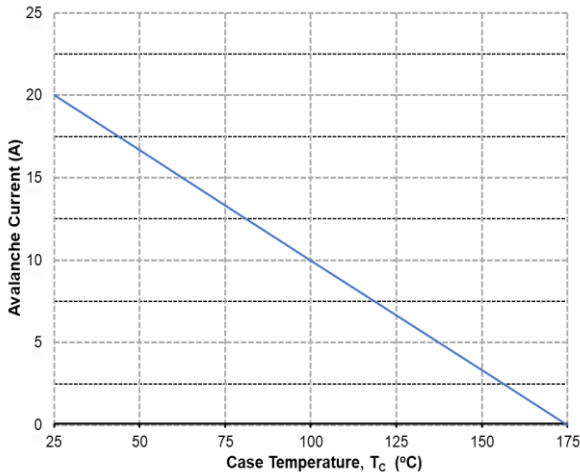

Figure 15. Single Avalanche vs. Temperature

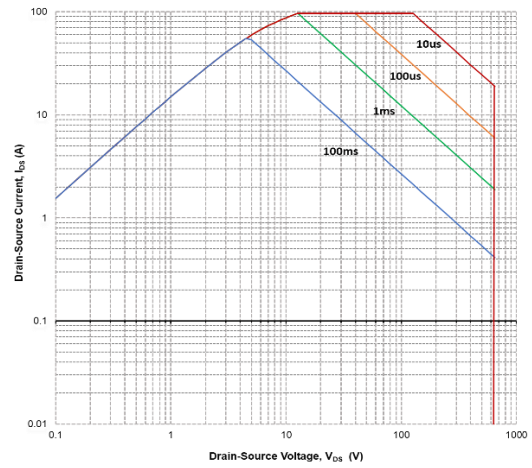
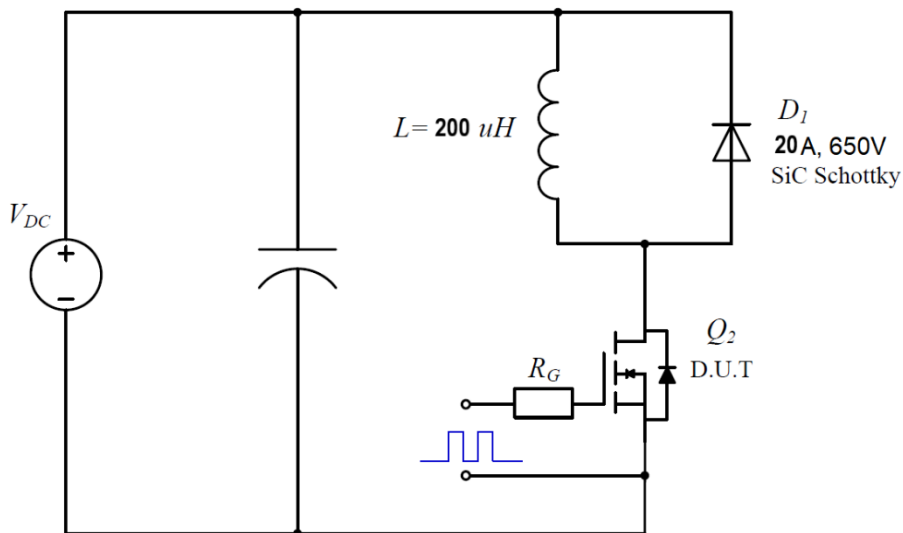
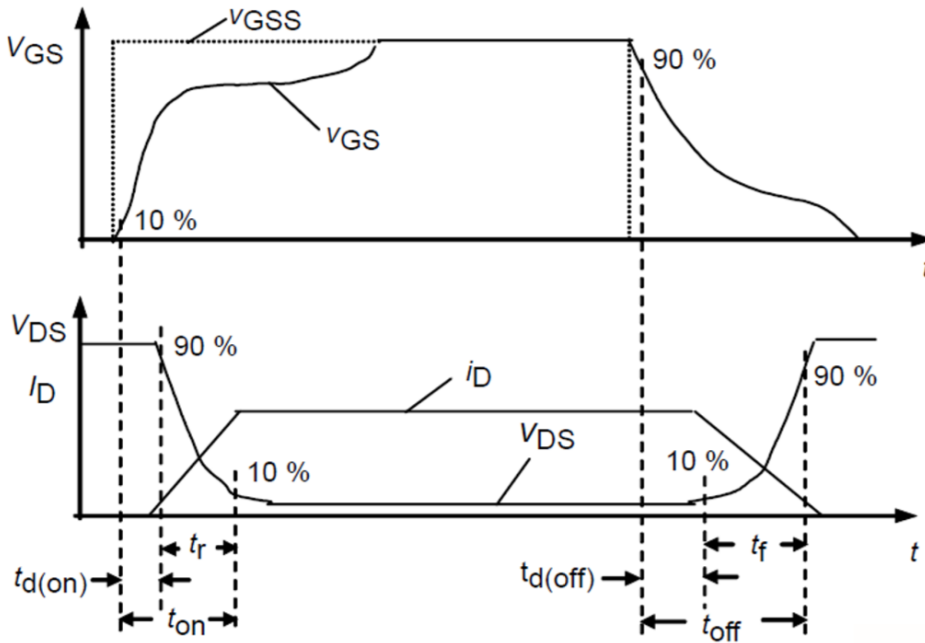

Figure 16. Safe Operating Area



Switching Times Definition and Test Circuit





Package Dimensions

(TO-247-4L Package)

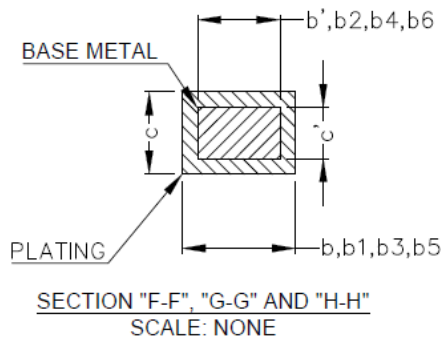
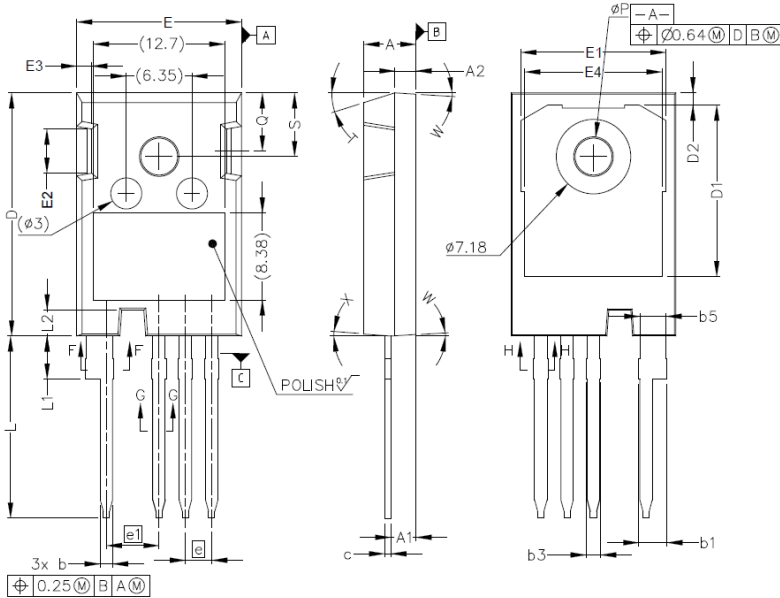

SYMBOL	MILLIMETERS	
	MIN	MAX
A	4.83	5.21
A1	2.29	2.54
A2	1.91	2.16
b'	1.07	1.28
b	1.07	1.33
b1	2.39	2.94
b2	2.39	2.84
b3	1.07	1.60
b4	1.07	1.50
b5	2.39	2.69
b6	2.39	2.64
c'	0.55	0.65
c	0.55	0.68
D	23.30	23.60
D1	16.25	17.65
D2	0.95	1.25
E	15.75	16.13
E1	13.10	14.15
E2	3.68	5.10
E3	1.00	1.90
E4	12.38	13.43
e	2.54 BSC	
e1	5.08 BSC	
N	4	
L	17.31	17.82
L1	3.97	4.37
L2	2.35	2.65
øP	3.51	3.65
Q	5.49	6.00
S	6.04	6.30
T	17.5° REF.	
W	3.5° REF.	
X	4° REF.	