



Driver LC 90W 200–800mA 230V bDW NFC h16 PRE4 16 mm premium NFC series

Product description

- Can be integrated in Casambi systems (Casambi Ready)
- NEW: lumDATA (Luminaire data, Energy reporting and Diagnostics & Maintenance)
- Dimmable built-in constant current LED driver
- Dimming range 1 – 100 %
- For luminaires of protection class I and protection class II
- Adjustable output current between 200 and 800 mA
- Max. output power 90 W
- Up to 95 % efficiency
- Power input on stand-by < 0.14 W
- Nominal lifetime up to 100,000 h
- 5 years guarantee (conditions at www.tridonic.com)

Housing properties

- Low profile metal casing with white cover
- Only 16 mm housing height
- Type of protection IP20

Interfaces

- basicDIM Wireless
- Near field communication (NFC)
- switchDIM
- Terminal blocks: 0° push terminals

Functions

- Adjustable output current in 1-mA-steps (NFC)
- lumDATA (Luminaire data, Energy reporting and Diagnostics & Maintenance)
- Constant light output function (eCLO)
- Power-up fading at AC
- Switch off the Driver with fade2zero
- Protective features (overtemperature, short-circuit, overload, no-load)
- Suitable for emergency lighting systems acc. to EN 50172

Benefits

- Flexible configuration via companionSUITE
- Support NFC multiple programming (full carton box)
- Application-oriented operating window for maximum compatibility
- Best energy savings due to low stand-by losses and high efficiency
- Reliability proven by lifetime up to 100,000 h and 5 years guarantee



Typical applications

- For linear/area lighting in office applications



Standards, page 3

Driver LC 90W 200–800mA 230V bDW NFC h16 PRE4

16 mm premium NFC series

Technical data

Rated supply voltage	220 – 240 V
AC voltage range	198 – 264 V
DC voltage range	176 – 280 V
Mains frequency	0 / 50 / 60 Hz
Overvoltage protection	320 V AC, 48 h
Typ. current (at 230 V, 50 Hz, full load) ¹⁾ ²⁾	419 mA
Typ. current (220 V, 0 Hz, full load, 15 % dimming level) ²⁾	74 mA
Leakage current	< 250 µA
Max. input power	95 W
Output power range (P _{rated})	9 – 90 W
Typ. efficiency (at 230 V / 50 Hz / full load) ²⁾	95 %
λ over full operating range (max.) ³⁾	0.99
λ over full operating range (min.)	0.56C
Typ. power consumption on stand-by	< 0.14 W
Typ. input current in no-load operation	42.8 mA
Typ. input power in no-load operation	0.37 W
In-rush current (peak / duration)	44.5 A / 141 µs
THD (at 230 V, 50 Hz, full load) ³⁾	< 5.5 %
Starting time (AC mode)	< 0.7 s
Starting time (DC mode)	< 0.3 s
Switchover time (AC/DC) ³⁾	< 0.08 s
Turn off time (at 230 V, 50 Hz, full load)	< 50 ms
Output current tolerance ³⁾	± 3 %
Max. output current peak (non-repetitive)	≤ output current + 40 %
Output LF current ripple (< 120 Hz)	± 1.5 %
Output P _{stLM} (at full load)	≤ 1
Output SVM (at full load)	≤ 0.4
Max. output voltage (no-load voltage)	250 V
Dimming range	1 – 100 %
Mains surge capability (between L – N)	≤ 1 kV
Mains surge capability (between L/N – PE)	≤ 2 kV
Surge voltage at output side (against PE)	< 2 kV
Radio transceiver operating frequencies	2.4 – 2.483 GHz
Max. output power radio transceiver (E.R.I.P.) ⁴⁾	< +20 dBm
Type of protection	IP20
Lifetime	up to 100,000 h
Guarantee (conditions at www.tridonic.com)	5 years
Dimensions L x W x H	360 x 30 x 16 mm

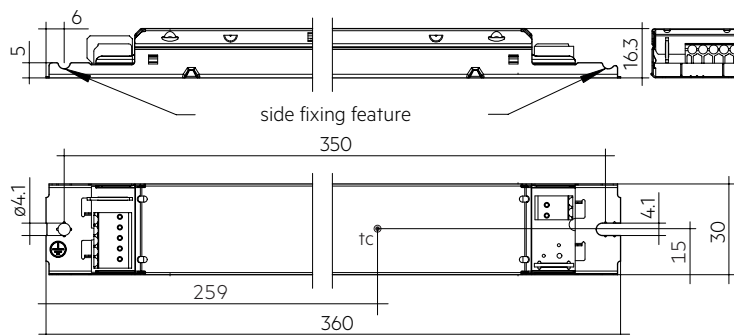

Ordering data

Type	Article number	Packaging carton	Packaging pallet	Weight per pc.
LC 90/200-800/230 bDW NF h16 PRE4	28004620	10 pc(s).	760 pc(s).	0.213 kg

Specific technical data

Type	Output current ⁵⁾	Min. forward voltage	Max. forward voltage	Max. output power	Typ. power consumption (at 230 V, 50 Hz, full load)	Typ. current consumption (at 230 V, 50 Hz, full load)	Max. casing temperature t _c	Ambient temperature ta max.
LC 90/200-800/230 bDW NF h16 PRE4	200 mA	45 V	230.0 V	46 W	49.0 W	220 mA	78 °C	-20 ... +65 °C
	300 mA	45 V	230.0 V	69 W	72.4 W	320 mA	80 °C	-20 ... +65 °C
	400 mA	45 V	225.0 V	90 W	94.2 W	415 mA	80 °C	-20 ... +65 °C
	500 mA	45 V	180.0 V	90 W	94.4 W	416 mA	80 °C	-20 ... +60 °C
	600 mA	45 V	150.0 V	90 W	94.6 W	416 mA	80 °C	-20 ... +60 °C
	700 mA	45 V	128.6 V	90 W	94.8 W	418 mA	84 °C	-20 ... +60 °C
	800 mA	45 V	112.5 V	90 W	95.0 W	419 mA	84 °C	-20 ... +60 °C

¹⁾ Valid at 100 % dimming level. Output current is mean value.

²⁾ Depending on the selected output current.

³⁾ Valid for immediate change of power supply type otherwise the starting time is valid.

⁴⁾ E.I.R.P.: Equivalent Isotropically Radiated Power.

⁵⁾ The table only lists a number of possible operating points but does not cover each single point. The output current can be set within the total value range in 1-mA-steps. Output current is mean value.

1. Standards

EN 55015
 EN 61000-3-2
 EN 61000-3-3
 EN 61000-4-4
 EN 61000-4-5
 EN 61347-1
 EN 61347-2-13
 EN 62384
 EN 61547
 ETSI EN 300 330
 ETSI EN 301 489-1
 ETSI EN 301 489-3
 ETSI EN 300 328
 ETSI EN 301 489-17
 According to EN 50172 for use in central battery systems
 According to EN 60598-2-22 suitable for emergency lighting installations

2. Thermal details and lifetime

2.1 Expected lifetime

Expected lifetime								
Type	Output current	ta	40 °C	45 °C	50 °C	55 °C	60 °C	65 °C
LC 90/200-800/230 bDW NF h16 PRE4	200 mA	tc	55 °C	59 °C	64 °C	68 °C	73 °C	78 °C
		Lifetime	> 100,000 h	> 100,000 h	> 100,000 h	> 100,000 h	90,000 h	60,000 h
	> 200 – 400 mA	tc	59 °C	63 °C	67 °C	72 °C	75 °C	80 °C
		Lifetime	> 100,000 h	> 100,000 h	> 100,000 h	90,000 h	70,000 h	50,000 h
	> 400 – 600 mA	tc	63 °C	66 °C	71 °C	74 °C	80 °C	–
		Lifetime	> 100,000 h	> 100,000 h	> 100,000 h	70,000 h	50,000 h	–
	> 600 – 800 mA	tc	67 °C	71 °C	76 °C	80 °C	84 °C	–
		Lifetime	> 100,000 h	> 100,000 h	95,000 h	70,000 h	50,000 h	–

The LED driver is designed for a lifetime stated above under reference conditions and with a failure probability of less than 10 %.

The relation of tc to ta temperature depends also on the luminaire design.
 If the measured tc temperature is approx. 5 K below tc max., ta temperature should be checked and eventually critical components (e.g. ELCAP) measured.
 Detailed information on request.

3. Installation / wiring

3.1 Circuit diagram

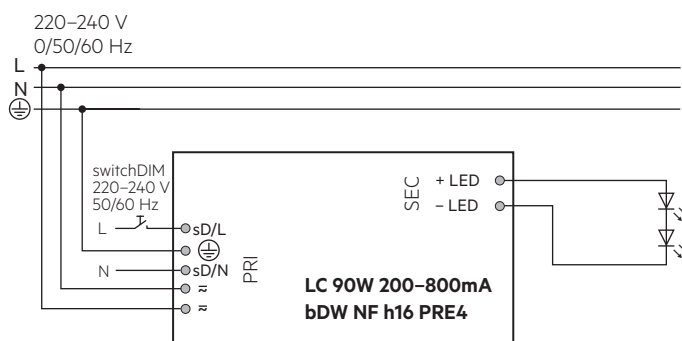

3.2 Wiring type and cross section

For wiring use solid wire from 0.5 – 1.5 mm².
 Strip 8 – 9 mm of insulation from the cables to ensure perfect operation of terminals.

LED module/LED driver/supply

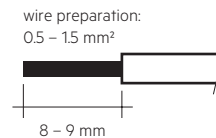

3.3 Loose wiring

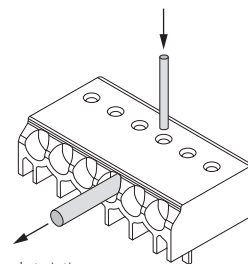

Loosen wire through twisting and pulling or using a Ø 1 mm release tool

3.4 Wiring guidelines

- Run the secondary lines separately from the mains connections and lines to achieve good EMC performance.
- The max. secondary cable length is 2 m (4 m circuit).
- For good EMC performance, keep the LED wiring as short as possible.
- Secondary switching is not permitted.
- The LED driver has no inverse-polarity protection on the secondary side. Wrong polarity can damage LED modules with no inverse-polarity protection.
- Wrong wiring of the LED driver can lead to malfunction or irreparable damage.
- To avoid the damage of the Driver, the wiring must be protected against short circuits to earth (sharp edged metal parts, metal cable clips, louver, etc.).

3.5 Hot plug-in



Hot plug-in is not supported due to residual output voltage of > 0 V up to mains voltage. Danger to life. When connecting an LED load, restart the device to activate the LED output. This can be done via mains reset or via interface (bdw, switchDIM).

3.6 Earth connection

The earth connection is conducted as protection earth (PE). The LED driver can be earthed via earth terminal or metal housing. If the LED driver will be earthed, protection earth (PE) has to be used. There is no earth connection required for the functionality of the LED driver. Earth connection is recommended to improve following behaviour.

- Electromagnetic interferences (EMI)
- LED glowing at stand-by
- Transmission of mains transients to the LED output
- Leakage current over LED module to earth on low dimming level

In general it is recommended to earth the LED driver if the LED module is mounted on earthed luminaire parts respectively heat sinks and thereby representing a high capacity against earth.

4. Electrical values

4.1 Operating window

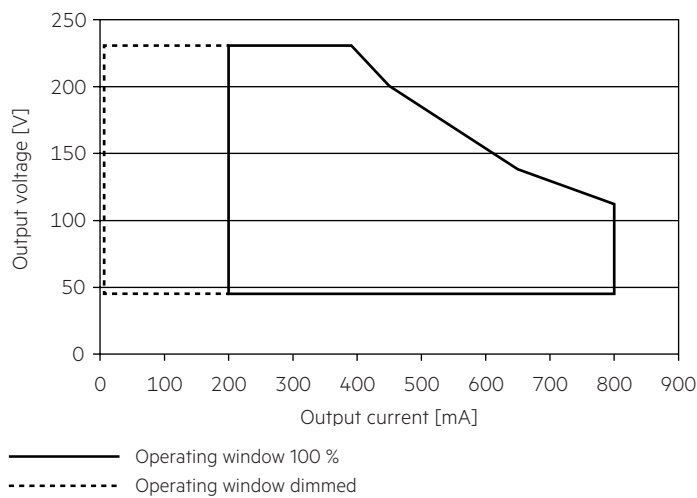

Make sure that the LED driver is operated within the given window under all operating conditions. Special attention needs to be paid at dimming and DC emergency operation as the forward voltage of the connected LED modules varies with the dimming level, due to the implemented amplitude dimming technology. Coming below the specified minimum output voltage of the LED driver may cause the device to shut-down. See chapter “6.9 DC operation” for more information.

4.2 Efficiency vs load

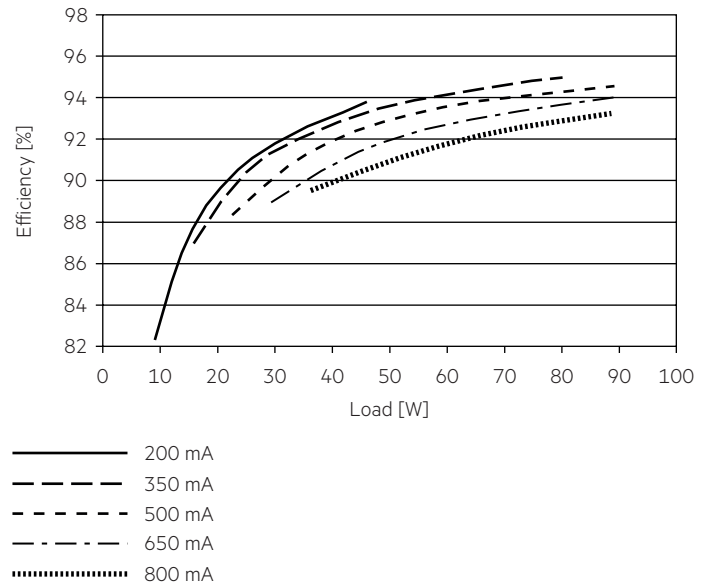

4.3 Power factor vs load

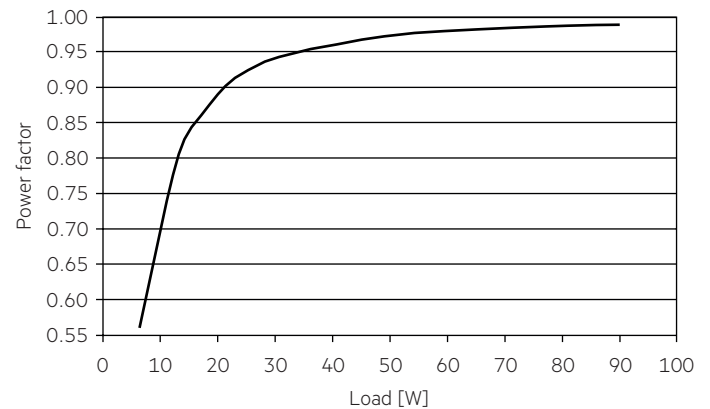

4.4 THD vs load

THD without harmonic < 5 mA (0.6 %) of the input current:

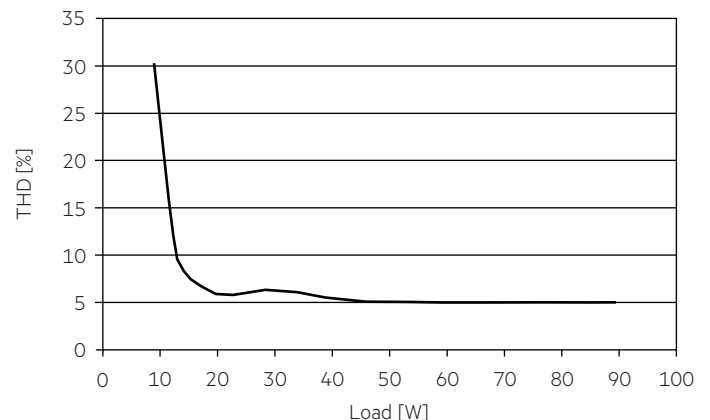

100 % load corresponds to the max. output power (full load) according to the table on page 2.

4.5 Maximum loading of automatic circuit breakers in relation to inrush current

Automatic circuit breaker type	C10	C13	C16	C20	B10	B13	B16	B20	Inrush current	
	Installation Ø	1.5 mm ²	1.5 mm ²	2.5 mm ²	2.5 mm ²	1.5 mm ²	1.5 mm ²	2.5 mm ²	2.5 mm ²	I _{max}
LC 90/200-800/230 bDW NF h16 PRE4	16	21	26	33	10	13	16	20	44.5 A	141 µs

These are max. values calculated out of inrush current! Please consider not to exceed the maximum rated continuous current of the circuit breaker.

Calculation uses typical values from ABB series S200 as a reference.

Actual values may differ due to used circuit breaker types and installation environment.

4.6 Harmonic distortion in the mains supply (at 230 V / 50 Hz and full load) in %

	THD	3.	5.	7.	9.	11.
LC 90/200-800/230 bDW NF h16 PRE4	< 7	< 6	< 1	< 1	< 1	< 1

Acc. to 61000-3-2. Harmonics < 5 mA or < 0.6 % (whatever is greater) of the input current are not considered for calculation of THD.

4.7 Dimming

Dimming range 1% to 100 %

Dimming curve is adapted to the eye sensitiveness.

Dimming is realized by amplitude dimming.

5. Software / Programming / Interfaces

5.1 Software / programming

With appropriate software and interface different functions can be activated and various parameters can be configured in the LED driver. The Driver supports the following software and interfaces:

Software / hardware for configuration:

- companionSUITE (deviceGENERATOR, deviceCONFIGURATOR, deviceANALYSER)

Interfaces for data transfer:

- NFC

5.2 Nearfield communication (NFC)

The NFC Interface allows wireless communication with the LED driver. This interface offers the option to write configuration and to read configuration, errors and events with the companionSUITE. A correct communication between the LED driver and the NFC antenna can only be guaranteed if the antenna is placed directly on the Driver. Any material placed between the LED driver and the NFC antenna can cause a deterioration of the communication quality. After programming the device via NFC power up the device one time for one second till the deviceANALYSER can read out the parameters. With a strong NFC antenna, several products can be programmed simultaneously ("multi device programming"). We recommend the use of following NFC antenna: www.tridonic.com/nfc-readers

NFC is complied with ISO/IEC 15963 standard.

5.3 Control input switchDIM

A standard push button can be connected on the input terminals. This function have to be activated before using.





























The control signal uses the usual mains voltage. It is essential to observe the specifications of the terminals (sD/L or sD/N) for connecting the switched phase of the pushbutton and the neutral wire. Profile change see handbook https://www.tridonic.com/com/en/download/technical/Documentation_Tridentonic_4remote_BT_EN.pdf

6. Functions

 companionSUITE:

NFC

The companionSUITE with deviceGENERATOR, deviceCONFIGURATOR and deviceANALYSER is available via our WEB page:
<https://www.tridonic.com/com/en/products/companionsuite.asp>

Icon	Function	NFC
	OEM Identification	
	OEM GTIN	
	Luminaire data	
	Label information	
	LED current	
	Device operating mode	
	Factory reset	
	Constant light output (CLO)	
	DC level	
	Enhanced power on level (ePOL)	
	Scenes and groups	
	Power-up fading	
	deviceKEY	
	Energy reports	

6.1 OEM Identification



The OEM (Original Equipment Manufacturer) can set his own identification number.

DALI Part 251: Memory bank 1 extension.

Store via NFC, read via bDW.

6.2 OEM GTIN



The Original Equipment Manufacturer (OEM) can set his own Global Trade Item Number (GTIN).

DALI Part 251: Memory bank 1 extension.

Store via NFC, read via bDW.

6.3 Luminaire data



This function provides the asset management with accurate data about the luminaire.

DALI Part 251: Memory bank 1 extension.

Store via NFC, read via bDW.

6.4 Label information



In production, an individual label can be printed out for each device.

For this there are different default values (Batch No., Production Date, ...) available.

In addition, you can use these two text input fields to insert your own luminaire information and print it out.

6.5 LED current



The LED output current must be adapted to the connected LED module. The value is limited by the current range of the respective device.

6.6 Factory reset



This device supports the function to reset all parameters back to factory defaults.

6.7 Enhanced Constant Light Output (eCLO)



With this function the light output of the LED module can be kept equal over the lifetime.

The light output of an LED module reduces over the course of its lifetime.

The Constant Light Output (eCLO) function compensates for this natural decline by constantly increasing the output current of the LED driver throughout its lifetime.

Enhanced eCLO shall be achieved by limitation of the LED current at the commissioning of the LED driver and providing a linear interpolation of the current over the time, depending on the data points given by the user.

The user has to insert up to eight pairs of data (time, level).

The output curve is the result of connecting the user data points linear.

Detailed description for eCLO see product manual.

The minimal CLO starting point is limited by the smallest output current of the LED driver.

6.8 Light level in DC operation



In emergency light systems with a central battery supply the DC recognition function uses the input voltage to detect if emergency mode is present.

The LED driver then automatically switches to DC mode and dims the light to the defined DC level.

Without DC recognition different and more complex solutions would have to be applied in order to detect emergency mode.

DC recognition is integrated in the device as standard.

No additional commissioning is necessary for activation.



This is a safety-relevant parameter.

The setting is relevant for the dimensioning of the central battery system.

The LED driver is designed to operate on DC voltage and pulsed DC voltage. For a reliable operation, make sure that also in DC emergency operation the LED driver is run within the specified conditions as stated in chapter "4.1 operating window".

Light output level in DC operation: programmable 1 – 100 %
(factory default = 15 %, EOF_i = 0.13).

The voltage-dependent input current of Driver incl. LED module is depending on the used load.

The voltage-dependent no-load current of Driver (without or defect LED module) is for:

AC: < 42.8 mA

DC: < 1.53 mA

Changing the dimming level in the bDW software is not possible when the driver is in DC mode.

If Dimming on DC is activated the requirements of the DC recognition function are ignored. Even if DC is detected the LED driver continues to behave as in AC mode.

6.9 deviceKEY

With this function, individual device functions can be protected from unauthorized changes by a password.

6.10 Energy reporting

This function provides the information related to energy reporting accessible through memory banks in this driver.

Several functions and values could be read out to gain access in Content management systems.

Report and values for Active power, Active Energy and many more can be read out.

7. Protective features

7.1 Intelligent temperature guard (ITG)



The Intelligent temperature guard (ITG) function provides effective protection against thermal overloads by slowly reducing the output if a defined internal temperature is exceeded.

The reduction of overtemperatures takes place in small steps every two minutes. As soon as the temperature drops again, the output power is gradually increased every 10 minutes.

On DC operation this function is deactivated to fulfill emergency requirements.

7.2 Intelligent Voltage Guard (IVG)



Intelligent Voltage Guard is the name of the electronic monitoring of the mains voltage. It immediately shows if the mains voltage rises above certain thresholds. Measures can then be taken quickly to prevent damage to the LED driver.

- If the mains voltage rises above approx. 280 Vrms (voltage depends on the LED driver type), the LED light starts flashing on and off.
- To avoid a damage of the LED driver the mains supply has to be switched off at this signal.

7.3 Short-circuit behaviour

In case of a short-circuit at the LED output the LED output is switched off. After restart of the LED driver the output will be activated again. The restart can either be done via mains reset or via interface.

7.4 No-load operation

The LED driver will not be damaged in no-load operation. The output will be deactivated and is therefore free of voltage. If a LED load is connected the device has to be restarted before the output will be activated again. The restart can either be done via mains reset or via interface.

7.5 Overload protection

If the maximum load is exceeded by a defined internal limit, the LED driver turns off the LED output. After restart of the LED driver the output will be activated again. The restart can either be done via mains reset or via interface.

7.6 Insulation between terminals

Insulation	Mains	PE	LED	sD
Mains	–	basic	–	–
PE	basic	–	basic	basic
LED	–	basic	–	–
sD	–	basic	–	–

basic ... represents basic insulation.

8. Miscellaneous

8.1 Insulation and electric strength testing of luminaires

Electronic devices can be damaged by high voltage. This has to be considered during the routine testing of the luminaires in production.

According to EN 60598-1 Annex Q (informative only!) or ENEC 303-Annex A, each luminaire should be submitted to an insulation test with 500 V_{DC} for 1 second. This test voltage should be connected between the interconnected phase and neutral terminals and the earth terminal. The insulation resistance must be at least 2 MΩ.

As an alternative, EN 60598-1 Annex Q describes a test of the electrical strength with 1500 V_{AC} (or 1.414 x 1500 V_{DC}). To avoid damage to the electronic devices this test must not be conducted.

8.2 Conditions of use and storage

Humidity: 5% up to max. 85%,
not condensed
(max. 56 days/year at 85%)

Storage temperature: -40 °C up to max. +80 °C

The devices have to be acclimatised to the specified temperature range (ta) before they can be operated.

The LED driver is declared as inbuilt LED controlgear, meaning it is intended to be used within a luminaire enclosure. If the product is used outside a luminaire, the installation must provide suitable protection for people and environment (e.g. in illuminated ceilings).

8.3 Placement

basicDIM Wireless has an integrated antenna for easy integration. In order to maximize the range in every direction some design guidelines should be taken into consideration when mounting the device. The antenna is located on the corner of the enclosure. It is on the top side of the internal PCB (Printed Circuit Board). When the device is mounted on a metal plate (e.g. frame of a luminaire), it may efficiently block the radio frequency signal. In this case, a cut-out underneath the antenna may be needed for the RF signal to exit the structure. The cut-out area should be as large as possible. Also the device should be placed as far away from any vertical metal structures as possible.

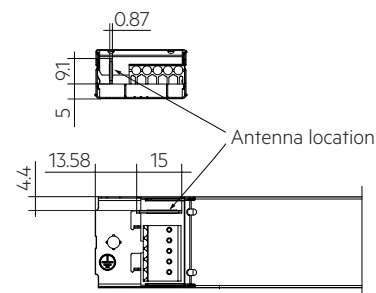

The range of the communication signal is depending on the environment e.g. luminaire, construction of the building, furnitures or humans and needs to be tested and approved in the installation.

The range of the LED drivers is up to 15 m (from unit to unit and from unit to App).

If the LED drivers are installed in a extremely well-shielded luminaire (metal body, spotlight, ...), then the range is up to 5 m.

This information is given as a guide. Luminaire construction, installation situation and construction conditions have a direct influence on the communication range and must be tested by the customer.

8.4 Network compatibility

This Driver is fully compatible with networks which support up to 250 nodes (Evolution networks). If the Driver is used with different types of basicDIM Wireless devices in an Evolution network, their compatibility has to be checked before. If a device is not compatible with Evolution networks, it can be only used in networks which support up to max. of 127 devices (Classic networks).

8.5 Maximum number of switching cycles

All LED driver are tested with 50,000 switching cycles.
The actually achieved number of switching cycles is significantly higher.

8.6 Additional information

Additional technical information at www.tridonic.com → Technical Data

Lifetime declarations are informative and represent no warranty claim.
No warranty if device was opened.